

DOCUMENTA MATHEMATICA

GEGRÜNDET 1996 DURCH DIE
DEUTSCHE MATHEMATIKER-VEREINIGUNG

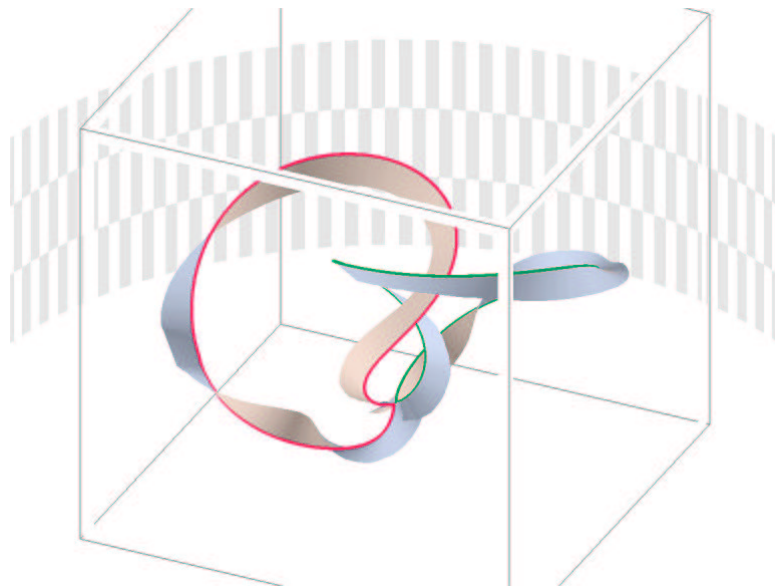

DECOMPOSING THE TREFOIL KNOT
INTO TWO LINKED TWISTED UNKNOTTED FILAMENTS
BY CROSSOVER COLLISION, SEE PAGE 695FF.

BAND 5 · 2000

DOCUMENTA MATHEMATICA veröffentlicht Forschungsarbeiten aus allen mathematischen Gebieten und wird in traditioneller Weise referiert.

DOCUMENTA MATHEMATICA erscheint am World Wide Web unter:

<http://www.mathematik.uni-bielefeld.de/documenta>

Artikel können als $\text{T}_{\text{E}}\text{X}$ -Dateien per E-Mail bei einem der Herausgeber eingereicht werden. Hinweise für die Vorbereitung der Artikel können unter der obigen WWW-Adresse gefunden werden.

DOCUMENTA MATHEMATICA publishes research manuscripts out of all mathematical fields and is refereed in the traditional manner.

DOCUMENTA MATHEMATICA is published on the World Wide Web under:

<http://www.mathematik.uni-bielefeld.de/documenta>

Manuscripts should be submitted as $\text{T}_{\text{E}}\text{X}$ -files by e-mail to one of the editors. Hints for manuscript preparation can be found under the above WWW-address.

GESCHÄFTSFÜHRENDE HERAUSGEBER / MANAGING EDITORS:

Alfred K. Louis, Saarbrücken	louis@num.uni-sb.de
Ulf Rehmann (techn.), Bielefeld	rehmann@mathematik.uni-bielefeld.de
Peter Schneider, Münster	pschnei@math.uni-muenster.de

HERAUSGEBER / EDITORS:

Don Blasius, Los Angeles	blasius@math.ucla.edu
Joachim Cuntz, Heidelberg	cuntz@math.uni-muenster.de
Bernold Fiedler, Berlin (FU)	fiedler@math.fu-berlin.de
Friedrich Götze, Bielefeld	goetze@mathematik.uni-bielefeld.de
Wolfgang Hackbusch, Leipzig (MPI)	wh@mis.mpg.de
Ursula Hamenstädt, Bonn	ursula@math.uni-bonn.de
Max Karoubi, Paris	karoubi@math.jussieu.fr
Rainer Kress, Göttingen	kress@math.uni-goettingen.de
Stephen Lichtenbaum, Providence	Stephen.Lichtenbaum@brown.edu
Alexander S. Merkurjev, Los Angeles	merkurev@math.ucla.edu
Anil Nerode, Ithaca	anil@math.cornell.edu
Thomas Peternell, Bayreuth	peternel@btm8x1.mat.uni-bayreuth.de
Wolfgang Soergel, Freiburg	soergel@sun7.mathematik.uni-freiburg.de
Günter M. Ziegler, Berlin (TU)	ziegler@math.tu-berlin.de

Title Page: Decomposing the trefoil knot into two linked twisted unknotted filaments by crossover collision, see page 695ff.

ISSN 1431-0635 (Print), ISSN 1431-0643 (Internet)



SPARC
LEADING EDGE

DOCUMENTA MATHEMATICA is a Leading Edge Partner of SPARC, the Scholarly Publishing and Academic Resource Coalition of the Association of Research Libraries (ARL), Washington DC, USA.

Address of Technical Managing Editor: Ulf Rehmann, Fakultät für Mathematik, Universität Bielefeld, Postfach 100131, D-33501 Bielefeld, Copyright © 2000 for Layout: Ulf Rehmann. Typesetting in $\text{T}_{\text{E}}\text{X}$, Printing: Schury Druck & Verlag, 83064 Raubling, Germany.

DOCUMENTA MATHEMATICA

BAND 5, 2000

ATALLAH AFFANE FORMULES DE REPRÉSENTATION INTÉGRALE POUR LES DOMAINES DE CARTAN	1–13
KARL-HEINZ HOFFMANN, VICTOR N. STAROVOITOV ZUR BEWEGUNG EINER KUGEL IN EINER ZÄHEN FLÜSSIGKEIT	15–21
A. ILIEV AND D. MARKUSHEVICH THE ABEL-JACOBI MAP FOR A CUBIC THREEFOLD AND PERIODS OF FANO THREEFOLDS OF DEGREE 14	23–47
N. CHRISTOPHER PHILLIPS A CLASSIFICATION THEOREM FOR NUCLEAR PURELY INFINITE SIMPLE C^* -ALGEBRAS	49–114
EVA MARIA FEICHTNER AND GÜNTER M. ZIEGLER THE INTEGRAL COHOMOLOGY ALGEBRAS OF ORDERED CONFIGURATION SPACES OF SPHERES	115–139
LAURENT BONAVERO AND SHIGEHARU TAKAYAMA SOME BOUNDEDNESS RESULTS FOR FANO-LIKE MOISHEZON MANIFOLDS	141–150
JINYA NAKAMURA ON THE MILNOR K -GROUPS OF COMPLETE DISCRETE VALUATION FIELDS	151–200
ELKE WILCZOK NEW UNCERTAINTY PRINCIPLES FOR THE CONTINUOUS GABOR TRANSFORM AND THE CONTINUOUS WAVELET TRANSFORM	201–226
CLAUDIA WULFF TRANSITIONS FROM RELATIVE EQUILIBRIA TO RELATIVE PERIODIC ORBITS	227–274
JENS LIEBERUM THE NUMBER OF INDEPENDENT VASSILIEV INVARIANTS IN THE HOMFLY AND KAUFFMAN POLYNOMIALS	275–299
HEINZ KÖNIG ON THE INNER DANIELL-STONE AND RIESZ REPRESENTATION THEOREMS	301–315

EREZ LAPID AND JONATHAN ROGAWSKI STABILIZATION OF PERIODS OF EISENSTEIN SERIES AND BESSEL DISTRIBUTIONS ON $GL(3)$ RELATIVE TO $U(3)$	317–350
ANDREW BAKER I_n -LOCAL JOHNSON-WILSON SPECTRA AND THEIR HOPF ALGEBROIDS	351–364
HANS-GEORG RÜCK AND ULRICH TIPP HEEGNER POINTS AND L -SERIES OF AUTOMORPHIC CUSP FORMS OF DRINFELD TYPE	365–444
J. F. JARDINE MOTIVIC SYMMETRIC SPECTRA	445–552
IVAN KAUSZ A MODULAR COMPACTIFICATION OF THE GENERAL LINEAR GROUP	553–594
RALPH J. BREMIGAN PSEUDOKÄHLER FORMS ON COMPLEX LIE GROUPS	595–612
MICHAEL BRINKMEIER STRONGLY HOMOTOPY-COMMUTATIVE MONOIDS REVISITED	613–624
ROBERT LAUTER, BERTRAND MONTHUBERT, VICTOR NISTOR PSEUDODIFFERENTIAL ANALYSIS ON CONTINUOUS FAMILY GROUPOIDS	625–655
M. V. BONDARKO LOCAL LEOPOLDT’S PROBLEM FOR RINGS OF INTEGERS IN ABELIAN p -EXTENSIONS OF COMPLETE DISCRETE VALUATION FIELDS	657–693
BERNOLD FIEDLER AND ROLF M. MANTEL CROSSOVER COLLISION OF SCROLL WAVE FILAMENTS	695–731

FORMULES DE REPRÉSENTATION INTÉGRALE
POUR LES DOMAINES DE CARTAN

ATALLAH AFFANE

Received: May 31, 1999

Communicated by Joachim Cuntz

ABSTRACT. For a bounded, symmetric and circled domain D in \mathbf{C}^n , considered as the unit ball of some Jordan triple system V , we give Koppelman-Leray and Cauchy-Leray formulas. These formulas supply us integral operators for solving the equation $\bar{\partial}u = f$ when f is a closed $(0, q)$ form with coefficients in $C^0(\bar{D})$. These operators, constructed by the help of the generic norm of V , are invariant by some Lie subgroup in the group of biholomorphic transformations of D and the solutions obtained satisfy an estimation of growth at the boundary.

2000 Mathematics Subject Classification: 32M15, 32F20.

Keywords and Phrases: $\bar{\partial}$ -problem, bounded symmetric domains.

1. INTRODUCTION.

Nous appellerons domaine de Cartan tout ouvert borné D de \mathbf{C}^n qui soit

- symétrique, c'est à dire que pour tout z de D , il existe une transformation biholomorphe involutive $\varphi \in \text{Aut}(D)$ dont z est un point fixe isolé.
- cerclé, c'est à dire qu'il contient l'origine et qu'il est stable par les transformations du type $z \rightarrow e^{it}z$, $t \in \mathbf{R}$.

Un domaine de Cartan est dit irréductible s'il n'est pas produit de deux autres domaines. La classification de tels domaines fournit quatre classes dénombrables et deux domaines exceptionnels, le premier dans \mathbf{C}^{16} , le second dans \mathbf{C}^{27} . Pour la classe des boules de Lie et le premier domaine exceptionnel, des formules de représentation intégrale ont été établies par Roos [7]. Plus tard, Hachaichi [2] a donné, pour la classe du disque généralisé, une formule permettant de résoudre le $\bar{\partial}$ -problème avec une estimation de croissance au bord. Dans ce travail, nous mettons à profit une approche algébrique, approche développée dans [5] et qui consiste à considérer un domaine de Cartan D comme la boule unité d'un système triple de Jordan V (associé canoniquement) pour obtenir deux formules générales, la première du type Koppelman-Leray, la seconde du

type Cauchy-Leray. Ces formules, construites à l'aide de la norme générique de V , fournissent des opérateurs de résolution $f \longrightarrow Tf$ du $\bar{\partial}$ -problème avec une donnée dans $C^0(\bar{D})$ et vérifiant des estimations de la forme:

$$\sup_{z \in D} |Tf(z)d(z, \partial D)^N| \leq C \sup_{z \in D} |f(z)|$$

où d est la distance usuelle et N un entier positif fonction de la dimension, du rang et du genre de V . Il s'avère que T est invariant par un certain sous groupe de Lie H du groupe des automorphismes de V , c'est à dire:

$$T(h^*f) = h^*(Tf) \quad \forall h \in H.$$

Lorsque D est irréductible, H n'est autre que le stabilisateur de l'origine dans $Aut(D)$. Dans la seconde section, nous rappellons certains éléments de la théorie des systèmes triples de Jordan qui permettent d'une part de prouver que les domaines de Cartan sont à pseudo-bord, de l'autre de construire de manière naturelle des sections de Leray. Dans les sections suivantes, nous donnons les formules annoncées et comme tous les éléments intervenant dans leur élaboration sont invariants par le stabilisateur de l'origine dans $Aut(D)$, l'invariance des opérateurs de résolution sera assurée.

2. LES DOMAINES DE CARTAN ET LES SYSTÈMES TRIPLES DE JORDAN.

La référence pour toutes les notions introduites dans cette section est [4], [5] et [6]. Nous appellerons système triple de Jordan (en abrégé STJ) un espace vectoriel V de dimension finie sur \mathbf{C} muni d'un triple produit

$$\begin{array}{ccccccc} V & \times & V & \times & V & \longrightarrow & V \\ x & & y & & z & \longrightarrow & \{ x \ y \ z \} \end{array}$$

\mathbf{C} -bilinéaire et symétrique en (x, y) , \mathbf{C} -antilinéaire en z et vérifiant l'identité

$$\{xy\{uvz\}\} - \{uv\{xyz\}\} = \{x\{yuv\}z\} - \{\{uvx\}yz\}.$$

Dans la suite, nous utiliserons les notations suivantes:

$$\{xyz\} = D(x, y)z = Q(x, z)y; \quad Q(x) = \frac{1}{2}Q(x, x)$$

$$B(x, y) = 1 - D(x, y) + Q(x)Q(y)$$

et nous désignerons par $Aut(V)$ le groupe des isomorphismes h de V tels que:

$$h(\{xyz\}) = \{h(x)h(y)h(z)\} \quad \forall x, y, z \in V.$$

Un sous-système de V est un sous espace-vectoriel W tel que $\{WWW\} \subseteq W$. Un idéal est un sous-espace vectoriel I tel que $\{IVV\} + \{VIV\} \subseteq I$ et nous

dirons que V est simple s'il ne possède pas d'idéal propre, semi simple s'il est somme d'idéaux simples. Un STJ est dit hermitien positif (en abrégé $STJHP$) si la forme hermitienne $\langle u | v \rangle = \text{tr}D(u, v)$ est définie positive. En fait, tout $STJHP$ est semi-simple. Pour tout ce qui suit, V désigne un $STJHP$ de dimension n et $\langle . | . \rangle$ son produit hermitien.

Un élément e de V est dit tripotent si $Q(e)e = e$. Lorsque deux tripotents e et e' vérifient l'une des propriétés équivalentes suivantes:

$$D(e, e') = 0 ; D(e', e) = 0 ; \{eee'\} = 0 ; \{e'e'e\} = 0$$

nous dirons qu'ils sont fortement orthogonaux. A tout tripotent e correspond une décomposition de V dite de Pierce. De fait, $D(e, e)$ est un endomorphisme de V auto-adjoint pour la forme hermitienne $\langle . | . \rangle$ et ne peut admettre comme valeurs propres que 0, 1 et 2. D'où la décomposition orthogonale

$$V = V_0 \oplus V_1 \oplus V_2$$

$V_i(e)$ étant le sous espace propre associé à la valeur propre i . Chacun des $V_i(e)$ est un sous système de V et on a la formule:

$$(1) \quad \{V_0V_2V\} = \{V_2V_0V\} = 0.$$

Un tripotent $e \neq 0$ est dit minimal si $V_2(e) = \mathbf{C}e$. Un repère est une famille maximale $\{e_i\}_{i=1, \dots, r}$ de tripotents minimaux fortement orthogonaux deux à deux. Comme deux repères sont conjugués par $\text{Aut}(V)$, tous les repères ont même cardinal que nous appellerons rang de V et noterons r . La hauteur d'un tripotent e sera par définition le rang du sous système $V_2(e)$ qui est aussi le nombre d'éléments d'une décomposition de e en somme de tripotents minimaux fortement orthogonaux deux à deux. Voici maintenant trois résultats de la théorie des STJ qui nous serons utiles.

THÉORÈME 2.1. *Un élément x de V s'écrit de manière unique*

$$x = \lambda^1 e_1 + \dots + \lambda^s e_s$$

où $\{e_i\}_{i=1, \dots, s}$ est une famille de tripotents fortement orthogonaux deux à deux et $0 \leq \lambda^1 < \dots < \lambda^s$ des nombres réels. Cette écriture s'appelle décomposition spectrale de x . De plus, la fonction $x \rightarrow |x| = \lambda^s$ est une norme que nous appellerons norme spectrale de V . La distance associée sera appelée distance spectrale et notée δ .

THÉORÈME 2.2. *i) La boule unité pour la norme spectrale d'un $STJHP$ est un domaine de Cartan, irréductible si et seulement si V est simple.*

ii) Un domaine de Cartan est de manière canonique la boule unité d'un $STJHP$ V . De plus, V est simple si et seulement si D est irréductible. Le stabilisateur de l'origine dans $\text{Aut}(D)$ est alors exactement $\text{Aut}(V)$.

Pour tout tripotent e le sous-système $V_0(e)$ est un *STJHP* et nous noterons D_e sa boule unité ouverte pour la norme spectrale. Comme conséquence de l'unicité de la décomposition spectrale, les sous ensembles $e + D_e$ sont disjoints deux à deux.

THÉORÈME 2.3. *Soit pour $j = 1, \dots, r$*

M_j *l'ensemble des tripotents de hauteur j ,*

$D_j = \{e + y; e \in M_j \text{ et } y \in D_e\}$,

$p_j : D_j \longrightarrow M_j$ *l'application qui à $x \in D_j$ associe l'unique $e \in M_j$ tel que $x \in D_e$.*

Alors

-Les M_j et les D_j sont des sous variétés analytiques réelles localement fermées de V et les $p_j : D_j \longrightarrow M_j$ sont des fibrés analytiques localement triviaux. Les M_j sont compacts. La frontière ∂D est la réunion des D_j .

-La codimension de D_j est la dimension complexe de $V_2(e)$, e étant un point quelconque de M_j .

- M_r est la frontière de Shilov de D .

- $\text{Aut}(V)$ est un groupe de Lie compact opérant sur chaque D_j .

LEMME 2.1. *Posons $D^j = D_j \cup \dots \cup D_r$ pour $j = 1, \dots, r$. Alors D_j est un ouvert dense de D^j .*

Preuve:

i) Montrons que D^{j+1} est fermé dans D^j . Soit $s > j$ et $\{x_l\}_{l \geq 1}$ une suite dans D_s convergente vers $x \in D^j$. Puisque M_s est compact, nous pouvons supposer que $x_l = y_l + e_l$ où les e_l convergent vers e dans M_s , $y_l \in V_0(e_l)$ et $|y_l| < 1$. A la limite, il vient $x = y + e$ avec $y \in V_0(e)$ et $|y| \leq 1$. Si $|y| < 1$, alors $x \in D_s$. Sinon, le théorème 2.1 appliqué à y comme élément du sous-système $V_0(e)$ donne $y = \lambda^1 \varepsilon_1 + \dots + \lambda^t \varepsilon_t + \varepsilon_{t+1}$. Puisque $\varepsilon_{t+1} \in V_0(e)$, on vérifie à l'aide de la formule (1) que $e + \varepsilon_{t+1}$ est un tripotent et que $V_2(e) \subseteq V_2(e + \varepsilon_{t+1})$; alors $x \in D_\tau$, $\tau \geq s$ étant la hauteur de $e + \varepsilon_{t+1}$. Ainsi, D_j est ouvert dans D^j .

ii) Soit $s > j$, $x \in D_s$ et $\lambda^1 \varepsilon_1 + \dots + \lambda^t \varepsilon_t + \varepsilon_{t+1}$ sa décomposition spectrale; comme la hauteur de ε_{t+1} est aussi sa hauteur dans le sous-système $V_2(\varepsilon_{t+1})$, il possède une décomposition $\varepsilon_{t+1} = \sigma_1 + \dots + \sigma_s$ en tripotents minimaux fortement orthogonaux deux à deux choisis dans $V_2(\varepsilon_{t+1})$. D'autre part, la formule (1) entraîne que les ε_i et les σ_j sont fortement orthogonaux deux à deux pour $1 \leq i \leq t$ et $1 \leq j \leq s$. Soit $x_l = \lambda^1 \varepsilon_1 + \dots + \lambda^t \varepsilon_t + \alpha_l (\sigma_{j+1} + \dots + \sigma_s) + \sigma_1 + \dots + \sigma_j$ où $0 < \alpha_l < 1$ et $\lim \alpha_l = 1$. Par construction, $x_l \in D_j$ et $\lim x_l = x$. Ceci prouve que $D^j \subseteq \overline{D_j}$.

Ce lemme et le théorème 2.3 assurent que D est à pseudo-bord au sens de [8] et que la formule de Stokes y est donc valable.

Dans tout ce qui suit, V sera identifié à \mathbf{C}^n par le choix d'une base orthonormale pour le produit hermitien $\langle \cdot | \cdot \rangle$. Alors $\det B(x, y)$ est un polynôme holomorphe en x , antiholomorphe en y et relié au noyau de Bergman $k(x, y)$ de D par la formule:

$$(2) \quad \det B(x, y) = (\text{vol}D)^{-1}k(x, y)^{-1} \forall x \in D, \forall y \in D.$$

Rappelons aussi la formule de transformation:

$$(3) \quad k(x, y) = J\varphi(x)k(\varphi(x), \varphi(y))\overline{J}\varphi(y) \quad \forall \varphi \in \text{Aut}(D)$$

(Ici $J\varphi$ désigne le jacobien de φ et $\overline{J}\varphi$ son conjugué).

Une propriété particulière des domaines de Cartan est que:

$$k(0, z) = k(z, 0) = k(0, 0) \quad \forall z \in D.$$

Par ailleurs, lorsque V est simple, il existe un entier positif g et un polynôme irréductible $N(x, y)$ tel que:

$$N(0, 0) = 1 \text{ et } \det B(x, y) = N(x, y)^g.$$

$N(x, y)$ s'appelle la norme générique et g le genre. Par construction, $N(x, y)$ est holomorphe en x , antiholomorphe en y et vérifie:

$$(4) \quad N(x, y) = \overline{N(y, x)} \text{ et } N(x, 0) = N(0, x) = 1$$

Si $V = V_1 \oplus \dots \oplus V_m$ où chaque V_i est un idéal simple de norme générique $N_i(x_i, y_i)$, nous poserons:

$$N((x_1, \dots, x_m), (y_1, \dots, y_m)) = \prod_{1 \leq i \leq m} N_i(x_i, y_i),$$

$$L(x, y) = N(x, y)N(y, x) - N(x, x)N(y, y).$$

Nous introduisons aussi le groupe de Lie:

$$\text{Aut}'(V) = \{h = (h_1, \dots, h_m); h_i \in \text{Aut}(V_i)\}.$$

Etant donné un repère $\{e_i\}_{i=1, \dots, r}$ et $x_j = a_j^1 e_1 + \dots + a_j^r e_r$ pour $j = 1, 2$ nous avons la formule:

$$(5) \quad N(x_1, x_2) = (1 - a_1^1 \overline{a_2^1}) \dots (1 - a_1^r \overline{a_2^r}).$$

PROPOSITION 2.1. *i) $N(x, y) \neq 0 \quad \forall x \in D, \forall y \in \overline{D}$.*

ii) $N(y, y) = 0 \quad \forall y \in \partial D$.

iii) $\forall x \in D, \forall y \in \overline{D}, L(x, y) \geq 0$ avec égalité si et seulement si $x = y$.

Preuve:

Il suffit de l'établir dans le cas où le système V est simple.

i) On a d'après la définition de $B(x, y)$, $B(x, \lambda y) = B(\lambda x, y)$ pour tout λ dans \mathbf{R} ce qui donne:

$$(6) \quad N(x, \lambda y) = N(\lambda x, y) \quad \forall \lambda \in \mathbf{R}, \forall x \in V, \forall y \in V.$$

Soit $x \in D$ et $y \in \overline{D}$; puisque D est une boule centrée en l'origine, il existe $\lambda \in \mathbf{R}$, $y' \in D$ tels que $\lambda x \in D$ et $y = \lambda y'$. Nous aurons donc $N(x, y) = N(x, \lambda y') = N(\lambda x, y')$. Or d'après (2), $N(\lambda x, y') \neq 0$.

ii) C'est une application de la formule (5) en observant que l'un des facteurs du terme de droite est nul.

iii) Soit $\langle \cdot, \cdot \rangle$ le produit hermitien usuel de $l^2(\mathbf{N})$, $\{\varphi_p\}_{p \in \mathbf{N}}$ une base hilbertienne de l'espace des fonctions holomorphes de carré intégrables et $\Phi : D \rightarrow l^2(\mathbf{N})$ définie par $\Phi(x) = \{\varphi_p(x)\}_{p \in \mathbf{N}}$. On sait que:

$$k(x, y) = \langle \Phi(x), \Phi(y) \rangle \quad \forall x \in D, \forall y \in D.$$

L'inégalité à établir n'est autre que celle de Cauchy-Schwartz et l'égalité n'a lieu que si $\Phi(x)$ et $\Phi(y)$ sont colinéaires, ce qui exige $x = y$. Enfin, pour $x \in D$ et $y \in \partial D$, d'après les points i) et ii), on a $L(x, y) > 0$.

LEMME 2.2. *On a l'inégalité:*

$$\inf_{y \in D} |N(x, y)| \geq \delta(x, \partial D)^r \quad \forall x \in D.$$

Preuve:

Soit x un point de D . Si $x = 0$, il suffit d'appliquer la formule (4). Soit donc $x \neq 0$ et considérons sur $D \times D$ la fonction $\Psi(u, y) = N(|x|u, y)^{-1}$. C'est une fonction holomorphe en u , antiholomorphe en y et continue sur $\overline{D} \times \overline{D}$ d'après le i) de la proposition 2.1. Pour u fixé dans \overline{D} , le principe du maximum donne un point t dans M_r tel que:

$$|\Psi(u, y)| \leq |\Psi(u, t)| \quad \forall y \in \overline{D}.$$

Toujours, par le principe du maximum appliqué maintenant à la fonction $w \rightarrow \Psi(w, t)$, il existe un point $s \in M_r$ tel que $|\Psi(u, y)| \leq |\Psi(s, t)|$. Mais en combinant la formule (6) et le iii) de la proposition 2.1, on obtient:

$$|\Psi(s, t)| \leq (N(|x|^{\frac{1}{2}}s, |x|^{\frac{1}{2}}s)N(|x|^{\frac{1}{2}}t, |x|^{\frac{1}{2}}t))^{-\frac{1}{2}}.$$

Or, d'après la formule (5), le terme de droite de cette inégalité vaut

$(1 - |x|)^{-r}$. Pour conclure, il suffit de prendre $u = \frac{x}{|x|}$ et de remarquer que

D étant la boule unité, l'inégalité $1 - |x| \geq \delta(x, \partial D)$ a lieu.

Nous adopterons la notation suivante:

$$(u, v) = \sum_{1 \leq j \leq n} u^j v^j \quad ; \quad \langle u | v \rangle = (u, \bar{v}) \text{ pour } u \text{ et } v \text{ dans } \mathbf{C}^n$$

et μ désignera la forme de Cauchy-Leray:

$$\mu(u, v) = \frac{(n-1)!}{(2i\pi)^n} \sum_{1 \leq j \leq n} (-1)^{j+1} \frac{u^j}{(u, v)^n} \Lambda_{m \neq j} du^m \Lambda_{1 \leq k \leq n} dv^k$$

définie sur $\{(u, v) \neq 0\}$. On sait que μ est fermée.

Nous terminerons cette section par le fait que toutes les notions qui y sont introduites¹ sont invariantes par le groupe $Aut'(V)$.

3. LA FORMULE DE KOPPELMAN-LERAY.

Dans cette section, nous adaptons aux domaines de Cartan qui en général ne sont ni strictement pseudo-convexes, ni de classe C^1 par morceaux la démarche de [3]. Le développement de Taylor du polynôme holomorphe $u \rightarrow N(u, t)$ au point $u = v$ s'écrit

$$(7) \quad N(u, t) = N(v, t) + (\alpha(u, v, t), (v - u))$$

où

$$\alpha^k(u, v, t) = - \int_0^1 \frac{\partial N}{\partial x^k}(u + s(v - u), t) ds.$$

Les $\alpha^k(u, v, t)$ sont des polynômes holomorphes en (u, v) et antiholomorphes en t . Posons alors $\omega(z, \xi) = \alpha(z, \xi, \xi)$; par construction et d'après les points i) et ii) de la proposition 2.1, ω est une section de Leray pour le domaine D holomorphe en z c'est à dire $(\omega(z, \xi), \xi - z) \neq 0$ pour tout z dans D et ξ dans ∂D . On introduit la section de Bochner-Martinelli $\sigma(z, \xi) = \bar{\xi} - \bar{z}$ et la section d'homotopie:

$$\eta(z, \xi, \lambda) = (1 - \lambda) \frac{\omega(z, \xi)}{(\omega(z, \xi), \xi - z)} + \lambda \frac{\sigma(z, \xi)}{(\sigma(z, \xi), \xi - z)}$$

définie pour $\xi \neq z$, $(\omega(z, \xi), \xi - z) \neq 0$ et $0 \leq \lambda \leq 1$. A l'aide de ces sections, on construit les formes différentielles:

$$\Omega = \frac{(n-1)!}{(2i\pi)^n} \sum_{1 \leq j \leq n} (-1)^{j+1} \frac{\bar{\xi}^j - \bar{z}^j}{(\sigma(z, \xi), \xi - z)^n} \Lambda_{m \neq j} (d\bar{\xi}^m - d\bar{z}^m) \Lambda_{1 \leq k \leq n} d\xi^k$$

¹norme spectrale, produit hermitien, norme générique, composantes D_j etc..

$$\underline{\Omega} = \frac{(n-1)!}{(2i\pi)^n} \sum_{1 \leq j \leq n} (-1)^{j+1} \eta^j(z, \xi, \lambda) \underset{m \neq j}{\Lambda} (\bar{\partial}_{z, \xi} + d\lambda) \eta^m(z, \xi, \lambda) \underset{1 \leq k \leq n}{\Lambda} d\xi^k.$$

REMARQUE 3.1. *Pour une transformation $h \in \text{Aut}'(V)$, une section $\rho(z, \xi)$ telle que $\bar{\rho}(h(z), h(\xi)) = h(\bar{\rho}(z, \xi))$ et une section $\rho'(z, \xi)$ vérifiant $\rho'(h(z), h(\xi)) = h(\rho'(z, \xi))$, la forme différentielle*

$$\sum_{1 \leq j \leq n} (-1)^{j+1} \rho^j(z, \xi) \underset{m \neq j}{\Lambda} d\rho^m \underset{1 \leq k \leq n}{\Lambda} d\rho'^k$$

est invariante par la transformation $\tilde{h}(z, \xi) = (h(z), h(\xi))$.

Ceci provient seulement du fait que si $h \in \text{Aut}'(V)$ alors $|\det h| = 1$. D'autre part, pour $h \in \text{Aut}'(V)$ l'identité $N(h(z), h(\xi)) = N(z, \xi)$ donne après calcul direct:

$$(8) \quad \bar{\alpha}(h(z), h(\xi), h(t)) = h(\bar{\alpha}(z, \xi, t)).$$

Etant donnée une $(0, q)$ forme f à coefficients continus sur \bar{D} , on définit par intégration partielle par rapport à ξ les formes différentielles:

$$B_D f(z) = \int_{\xi \in D} f(\xi) \Lambda \Omega(z, \xi) \quad R_{\partial D}^\omega f(z) = \int_0^1 d\lambda \int_{\xi \in \partial D} f(\xi) \Lambda \underline{\Omega}(z, \xi, \lambda)$$

$$Tf = (-1)^q (B_D f + R_{\partial D}^\omega f).$$

Pour $q = 0$, on a $B_D f = 0$ et $R_{\partial D}^\omega f = 0$ tandis que pour $q \geq 1$, on obtient des formes de type $(0, q - 1)$ en z .

LEMME 3.1. *Les opérateurs B_D et $R_{\partial D}^\omega$ sont invariants par $\text{Aut}'(V)$ c'est à dire:*

$$h^* B_D f = B_D h^* f \quad \text{et} \quad h^* R_{\partial D}^\omega f = R_{\partial D}^\omega h^* f \quad \forall h \in \text{Aut}'(V).$$

Preuve:

Pour $h \in \text{Aut}'(V)$, notons \tilde{h} l'endomorphisme de $V \times V$ défini par $\tilde{h}(z, \xi) = (h(z), h(\xi))$. Il est trivial que la remarque 3.1 s'applique aux sections $\rho(z, \xi) = \sigma(z, \xi)$ et $\rho'(z, \xi) = \xi$. D'après la formule (8), elle est également applicable pour $\rho = \eta$ et $\rho' = \xi$; on obtient ainsi $\tilde{h}^* \Omega = \Omega$ et $\tilde{h}^* \underline{\Omega} = \underline{\Omega}$. Il suffit donc, d'effectuer dans les intégrales définissant $B_D h^* f$ et $R_{\partial D}^\omega h^* f$ le changement de variable $h(\xi) = \tau$ pour retrouver $h^* B_D f$ et $h^* R_{\partial D}^\omega f$.

THÉORÈME 3.1. *Etant donnée une $(0, q)$ forme ($q = 1, \dots, n$) f continue sur \bar{D} telle que ∂f soit aussi continue sur \bar{D} on a:*

$$f = T\bar{\partial}f + \bar{\partial}Tf.$$

En particulier, pour $q = 1, \dots, n$ et si $\bar{\partial}f = 0$, Tf est solution de l'équation $\bar{\partial}u = f$. De plus, cet opérateur de résolution T vérifie:

$$Th^*f = h^*Tf \quad \forall h \in \text{Aut}'(V).$$

Enfin, il existe $C > 0$ tel que

$$\sup_{z \in D} |Tf(z)\delta(z, \partial D)^{r(n-1)}| \leq C \sup_{z \in D} |f(z)|.$$

Preuve:

Du moment que l'on a construit ci-dessus une section de Leray holomorphe en z et que la formule de Stokes est applicable, il suffit de reprendre mutadis mutandis les paragraphes [1.6]-[1.12] de [3] pour avoir la formule de représentation intégrale annoncée.

La propriété d'invariance de T résulte directement du lemme 3.1.

Pour l'estimation de croissance au bord, toujours suivant [3], on n'a besoin de l'établir que pour l'opérateur $R_{\partial D}^{\omega}$. Or d'après les calculs effectués dans le paragraphe [2.2] de [3], les coefficients de $R_{\partial D}^{\omega}f$ sont des combinaisons linéaires d'intégrales de la forme:

$$E(z) = \int_{\xi \in \partial D} \frac{f_I(\xi)\Gamma(z, \xi)}{N(z, \xi)^{n-s-1} \langle z - \xi | z - \xi \rangle^{(s+1)} \prod_{m \neq j} \Lambda_{m \neq j} d\bar{\xi}^m \prod_{1 \leq k \leq n} \Lambda_{1 \leq k \leq n} d\xi^k}$$

où $0 \leq s \leq n - 2$, $1 \leq m \leq n$, f_I est un coefficient de f et Γ une expression ne dépendant que de la section ω et vérifiant une inégalité du type

$$|\Gamma(z, \xi)| \leq C |z - \xi| \quad \forall z \in D, \forall \xi \in D.$$

Appliquons le lemme 2.2, il vient:

$$\delta(z, \partial D)^{r(n-1)} |E(z)| \leq C \sup_{z \in D} |f(z)| \int_{\xi \in \partial D} |z - \xi|^{-(2n-3)} \quad \forall z \in D.$$

Mais par la formule de Stokes, cette dernière intégrale se majore par $\int_{\xi \in D} |z - \xi|^{-(2n-2)}$ qui est bornée en z .

4. LA FORMULE DE CAUCHY-LERAY.

Appliquons l'identité (7) pour $u = z$, $v = \xi$, $t = \xi$, puis pour $u = z$, $v = \xi$, $t = z$, il vient:

$$N(z, \xi) = N(\xi, \xi) + (\alpha(z, \xi, \xi), \xi - z); \quad N(z, z) = N(\xi, z) + (\alpha(z, \xi, z), \xi - z).$$

On aura alors $L(z, \xi) = (s(\xi, z), \xi - z)$ avec

$$s(\xi, z) = N(\xi, z)\alpha(z, \xi, \xi) - N(\xi, \xi)\alpha(z, \xi, z).$$

Il est évident que $s(z, z) = 0$ et donc il existe $C > 0$ tel que:

$$(9) \quad |s(\xi, z)| \leq C |\xi - z| \quad \forall z, \xi \in \overline{D}.$$

Sur l'ouvert $\{L(z, \xi) \neq 0\}$, considérons la forme différentielle:

$$K(\xi, z) = \frac{(n-1)!}{(2i\pi)^n} \sum_{1 \leq j \leq n} (-1)^{j+1} \frac{s^j(\xi, z)}{(s(\xi, z), \xi - z)^n} \wedge_{m \neq j} ds^m \wedge_{1 \leq k \leq n} (d\xi^k - dz^k).$$

C'est l'image réciproque de μ par l'application qui à (z, ξ) associe $(s(\xi, z), \xi - z)$; elle est donc fermée. Pour $1 \leq q \leq n$, on note K^q la composante de bidegré $(n, n - q)$ en ξ et de bidegré $(0, q - 1)$ en z .

LEMME 4.1. *Soit des STJHP simples V_i , de boule unité Δ_i pour $i = 1, \dots, m$, $V = \oplus V_i$ et D la boule unité de V . Notons $Aut'(D) = \{\varphi = (\varphi_1, \dots, \varphi_m); \varphi_i \in Aut(\Delta_i) \forall i = 1, \dots, m.\}$. Pour un point z de D et φ dans $Aut'(D)$ telle $\varphi(0) = z$, on a*

$$L(z, \xi) = |N(z, \xi)|^2 L(0, \varphi^{-1}(\xi)) \quad \forall \xi \in D.$$

Preuve:

Il s'agit d'appliquer plusieurs fois la formule (3) à chacun des systèmes simples V_i .

LEMME 4.2. *i) On a l'inégalité*

$$L(0, \tau) \geq |\tau|^2 \quad \forall \tau \in D.$$

ii) *Pour tout point $z \in D$, il existe $C_z > 0$ et un voisinage U_z tels que:*

$$L(z, \xi) \geq C_z |z - \xi|^2 \quad \forall \xi \in U_z.$$

Preuve:

i) Par la formule (4) on a $L(0, \tau) = 1 - N(\tau, \tau)$ pour tout τ dans D . Or, la décomposition spectrale d'un point $\tau \in D$ s'écrit $\tau = \lambda^1 e_1 + \dots + \lambda^r e_r$ où les e_i constituent un repère et $|\tau| = \sup \lambda^i$; d'après l'identité (5) on aura $N(\tau, \tau) \leq 1 - |\tau|^2$ ce qui suffit.

ii) Soit $z \in D$, puisque $Aut'(D)$ opère transitivement sur D , choisissons $\varphi \in Aut'(D)$ tel que $\varphi(0) = z$. D'après le théorème des accroissements finis, il existe

un voisinage W de z et une constante $C > 0$ tels que $|\varphi^{-1}(\xi)| \geq C|z - \xi|$ pour tout ξ dans W . On conclut alors en utilisant le lemme 4.1 et le point i).

Ainsi, pour $z \in D$ fixé et tenant compte de l'inégalité (9), la fonction $s(\xi, z)/L(z, \xi)^n$ est intégrable sur D . On peut donc définir pour toute forme différentielle u de type $(0, q - 1)$, ($2 \leq q \leq n + 1$), la $(0, q - 2)$ forme:

$$\bar{T}u(z) = (-1)^q \int_{\xi \in D} u(\xi) \Lambda K^{q-1}(\xi, z).$$

LEMME 4.3. i) $\bar{\partial}_\xi K^1(\xi, z) = 0$ et pour $q \geq 2$, on a $\bar{\partial}_\xi K^q(\xi, z) = -\bar{\partial}_z K^{q-1}(\xi, z)$.

ii) Pour $q \geq 2$, on a $K^q(\xi, z) = 0$ lorsque $z \in D$ et $\xi \in \partial D$.

Preuve:

i) Provient du fait que la forme différentielle K est fermée.

ii) En reprenant l'expression de K , on constate que K^q provient de la somme:

$$\sum_{1 \leq j \leq n} (-1)^{j+1} \frac{s^j(\xi, z)}{(s(\xi, z), \xi - z)^n} \Lambda_{m \neq j} \bar{\partial} s^m \Lambda_{1 \leq k \leq n} d\xi^k.$$

D'autre part, un calcul direct donne:

$$\bar{\partial}_z s^i(\xi, z) \Lambda \bar{\partial}_z s^j(\xi, z) = 0 \quad \forall z \in D, \xi \in \partial D \text{ et } 1 \leq i, j \leq n.$$

Ceci assure le lemme pour $q \geq 3$. Pour $q = 2$, on constate après calcul que K^2 est multiple de

$$\sum_{i < j} (-1)^{j+i} (s^i \bar{\partial}_z s^j - s^j \bar{\partial}_z s^i) \Lambda_{k \neq i, j} \bar{\partial}_\xi s^k$$

et on vérifie que sur $\{z \in D, \xi \in \partial D\}$, on a $s^i \bar{\partial}_z s^j - s^j \bar{\partial}_z s^i = 0 \quad \forall 1 \leq i, j \leq n$.

LEMME 4.4. Il existe $C > 0$ telle que:

$$|\varphi(\tau) - \varphi(0)| \leq C|\tau| \quad \forall \varphi \in \text{Aut}(D), \forall \tau \in D$$

Preuve:

Comme D est la boule unité, on a $|\varphi(\tau)| \leq 1$ pour tout τ dans D et φ dans $\text{Aut}(D)$. D'après la formule de Cauchy pour les polydisques, il existe $C > 0$ telle que:

$$\sup_{\varphi \in \text{Aut}(D), |\tau| \leq \frac{1}{2}} |D_\tau \varphi| \leq C.$$

Le théorème des accroissements finis donne alors le lemme sur $\{|\tau| \leq \frac{1}{2}\}$. Sur le complémentaire $\{|\tau| \geq \frac{1}{2}\}$ l'inégalité à établir est triviale.

THÉORÈME 4.1. Soit pour $1 \leq q \leq n+1$ une $(0, q-1)$ forme u continue sur \overline{D} telle que $\overline{\partial}u$ soit aussi continue sur \overline{D} , alors:

i) si $q \geq 2$, on a $u = (-1)^q \overline{T} \overline{\partial}u + \overline{\partial}_z \overline{T}u$.

ii) pour $q = 1$, on a $u(z) = \int_{\xi \in \partial D} u(\xi) K^1(z, \xi) - \overline{T} \overline{\partial}u(z) \quad \forall z \in D$.

iii) $\overline{T}(h^*u) = h^*(\overline{T}u) \quad \forall h \in \text{Aut}'(V)$.

iv) On suppose $V = \bigoplus_{1 \leq i \leq m} V_i$ et pour tout i , soit $k_i, g_i, r_i, \delta_i, \Delta_i$ les noyaux de Bergman, genres, rangs, distances spectrales et boules unité de chacun des STJHP simples V_i . Posons $N(i) = r_i(2n - g_i)$; alors il existe $C > 0$ telle que:

$$\sup_{(z_1, \dots, z_m) \in D} \prod_{1 \leq i \leq m} \delta_i(z_i, \partial \Delta_i)^{N(i)} | \overline{T}u(z_1, \dots, z_m) | \leq C \sup_{z \in D} | u(z) | .$$

Preuve:

Grace au lemme 4.3, on peut reprendre le raisonnement du paragraphe 1 de [1] et obtenir ainsi les points i) et ii).

iii) Par ailleurs la formule (8) assure que la remarque 3.1 est applicable pour les sections $\rho = s$ et $\rho'(z, \xi) = \xi - z$; on aura ainsi $\tilde{h}^*K = K$ pour tout h dans $\text{Aut}'(V)$ et après le changement de variables $\xi' = h(\xi)$ dans l'intégrale qui définit $\overline{T}(h^*u)$, on retrouve $h^*(\overline{T}u)$.

iv) Les coefficients de $\overline{T}u(z)$ sont des combinaisons linéaires d'intégrales de la forme:

$$F(z) = \int_{\xi \in D} \frac{R_I(z, \xi) u_I(\xi) s^j(\xi, z)}{L(z, \xi)^n}$$

où u_I est un coefficient de u , R_I un polynome et $j = 1, \dots, n$. Soit $\varphi \in \text{Aut}'(D)$ telle que $\varphi(0) = z$; on aura à l'aide du lemme 4.1 et du i) du lemme 4.2 l'inégalité:

$$| \overline{T}u(z) | \leq C \sup_{t \in D} | u(t) | \int_{\xi \in D} \frac{| s(\xi, z) |}{| \varphi^{-1}(\xi) |^{2n} | N(z, \xi) |^{2n}}$$

Effectuons le changement de variable $\xi = \varphi(\tau)$ puis utilisons le lemme 4.4 et la formule (9), cette intégrale sera majorée par:

$$\int_{\tau \in D} | J\varphi(\tau) |^2 | \tau |^{1-2n} | N(z, \varphi(\tau)) |^{-2n} .$$

Mais la formule (3) donne:

$$| J\varphi_i(\tau_i) |^2 = k_i(0, 0) k_i(z_i, z_i) | k_i(z_i, \varphi_i(\tau_i)) |^{-2}$$

et on conclut alors en appliquant le lemme 2.2 à chaque V_i .

REFERENCES

- [1] P. Charpentier, *Formules explicites pour les solutions minimales de l'équation $\bar{\partial}u = f$ dans la boule et le polydisque de C^n* . Ann. Inst. Fourier 30, 4 (1980), 121-154.
- [2] M. S. Hachaichi, *Formules de représentation intégrale des formes différentielles et application à la résolution de l'équation de Cauchy-Riemann dans le disque généralisé de $M_n(C)$* . Thèse de Doctorat d'Etat, U.S.T.H.B. Alger (1998).
- [3] G. M. Henkin, J. Leiterer, *Theory of functions on complex manifolds*. Birkhauser-Verlag. Basel-Boston-Stuttgart (1984).
- [4] O. Loos, *Jordan pairs*. Lect. Notes in Math. Vol 460 (1975).
- [5] O. Loos, *Bounded symmetric domains and Jordan pairs*. Univ. of California at Irvine (1977).
- [6] G. Roos, *La géométrie des domaines hermitiens symétriques et les systèmes triples de Jordan*. Univ. de Poitiers, dpt de Math. Prépublication n°18 (1985).
- [7] G. Roos, *Fonctions de plusieurs variables complexes et formules de représentation intégrale*. Thèse de Doctorat d'Etat. Paris VII (1983).
- [8] L. Schwartz, *Cours d'analyse*. Hermann. Paris (1967).

Atallah Affane
Institut de Mathématiques
U.S.T.H.B, B.P. 32 El Alia
Bab Ezzouar
Algiers, Algeria.
atallahaffane@hotmail.com

ZUR BEWEGUNG EINER KUGEL
IN EINER ZÄHEN FLÜSSIGKEIT

KARL-HEINZ HOFFMANN, VICTOR N. STAROVOITOV

Received: March 13, 1997

Communicated by Alfred K. Louis

ABSTRACT. In dieser Arbeit untersuchen wir die Bewegung einer Festkugel im beschränkten Gebiet, das mit einer inkompressiblen zähen Flüssigkeit gefüllt ist. Wir beweisen, dass die Festkugel die Wand des Behälters mit der Geschwindigkeit Null erreicht. Als eine Folgerung wird die Lösbarkeit der Aufgabe gezeigt.

1991 Mathematics Subject Classification: 35Q30

1 EINFÜHRUNG UND HAUPTERGEBNISSE.

Es sei Ω ein Gebiet im R^3 mit Rand $\partial\Omega$. Wir nehmen an, daß Ω mit einer inkompressiblen Flüssigkeit gefüllt ist, und ein Festkörper darin schwimmt. Das Ziel dieser Arbeit ist es, diese Bewegung zu beschreiben.

Die Hauptschwierigkeit der Aufgabe besteht darin, daß der Körper an die Wand des Behälters stoßen kann. Es ist nicht ganz klar, welche Bedingungen man in diesem Moment erhält. Daher wurde das Problem bisher mathematisch nur für solche Gebiete betrachtet, die mit dem ganzen Raum übereinstimmen ([1], [2]). Eine Übersicht über mechanische und numerische Behandlungen des Problems kann man in [3] finden. In [4] haben wir für den zweidimensionalen Fall bewiesen, daß der Körper die Wand mit der Geschwindigkeit Null erreicht, wenn sein Rand und der Rand des Gebietes zur Klasse C^2 gehören. Als eine Folgerung wurde die Lösbarkeit der Aufgabe gezeigt. Jetzt wird dieses Ergebnis auf den dreidimensionalen Fall erweitert werden. Wir setzen einschränkend voraus, daß das Gebiet Ω und der Körper Kugeln sind. Die Ergebnisse gelten aber auch, wenn man mehrere Kugeln im Gebiet betrachtet. Diese Voraussetzung wird eigentlich nur im Satz 2 benutzt. Um die Berechnungen zu vereinfachen, nehmen wir außerdem an, daß die Dichten der Flüssigkeit und des Körpers beide gleich eins sind, und keine Volumenkräfte vorhanden sind.

Es seien $V(t)$ das Gebiet, das der Festkörper einnimmt, und $\Gamma(t)$ sein Rand zur Zeit t . Es ist die Aufgabe, das Geschwindigkeitsfeld \bar{v} der Flüssigkeit, die Geschwindigkeit $\bar{u}_* = d\bar{x}_*/dt$ des Schwerpunktes \bar{x}_* des Festkörpers (des Mittelpunktes der Kugel V) und seine Winkelgeschwindigkeit $\bar{\omega}$ zu finden, die den Gleichungen

$$\begin{aligned} \bar{v}_t + (\bar{v} \cdot \nabla)\bar{v} &= \operatorname{div} P, \\ \operatorname{div} \bar{v} &= 0, & \bar{x} \in \Omega \setminus V(t) \end{aligned} \quad (1.1)$$

$$\begin{aligned} P &= -pI + D(\bar{v}), \\ m \frac{d\bar{u}_*}{dt} &= \int_{\Gamma(t)} P \langle \bar{n} \rangle ds, \\ J_* \frac{d\bar{\omega}}{dt} &= \int_{\Gamma(t)} (\bar{x} - \bar{x}_*) \times P \langle \bar{n} \rangle ds, \end{aligned} \quad (1.2)$$

genügen. Hier sind m die Masse des Körpers, J_* der Tensor des Inertiamomentes des Körpers bezüglich seines Schwerpunktes, P der Spannungstensor, p der Druck und $D(\bar{v})$ der Deformationsgeschwindigkeitstensor mit den Komponenten

$$D_{ij}(\bar{v}) = \frac{1}{2} \left(\frac{\partial v_i}{\partial x_j} + \frac{\partial v_j}{\partial x_i} \right).$$

Für das Gleichungssystem (1.1)–(1.2) stellen wir folgende Rand- und Anfangsbedingungen

$$t = 0 : \quad \bar{v} = \bar{v}_0, \quad \bar{u}_* = \bar{u}_*^0, \quad \bar{\omega} = \bar{\omega}_0, \quad V = V_0, \quad (1.3)$$

$$\Gamma(t) : \quad \bar{v}(\bar{x}, t) = \bar{u}_*(t) + \bar{\omega}(t) \times (\bar{x} - \bar{x}_*(t)), \quad (1.4)$$

$$\partial\Omega : \quad \bar{v} = 0. \quad (1.5)$$

Wir nennen (1.1)–(1.5) *Aufgabe A*.

Nun definieren wir den Begriff der verallgemeinerten Lösung der Aufgabe A.

Es seien

$$\varphi(\bar{x}, t) = \begin{cases} 1, & \bar{x} \in V(t), \\ 0, & \bar{x} \in \Omega \setminus V(t), \end{cases}$$

$$K(\chi) = \{\bar{\psi} \in H_0^1(\Omega) \mid D(\bar{\psi})(\bar{x}) = 0 \text{ für } \bar{x} \in S(\chi), \operatorname{div} \bar{\psi} = 0\},$$

wobei χ die charakteristische Funktion einer Teilmenge von Ω ist, und $S(\chi)$ die Menge der Punkte mit $\chi = 1$ bezeichnet. Mit $L_p(0, T; K(\chi))$, $p \geq 1$, bezeichnen wir die Menge der Funktionen aus $L_p(0, T; H_0^1(\Omega))$, die für fast alle $t \in [0, T]$ zu $K(\chi)$ gehören.

Es seien $Char(E)$ die Klasse der charakteristischen Funktionen aller Teilmengen einer Menge E und $Q = [0, T] \times \Omega$ für $T < \infty$.

DEFINITION 1. *Ein Paar von Funktionen*

$$\begin{aligned} \bar{v} &\in L_\infty(0, T; L_2(\Omega)) \cap L_2(0, T; K(\varphi)), \\ \varphi &\in Char(Q) \cap C^{1/p}(0, T; L_p(\Omega)), \quad 1 < p < \infty, \end{aligned}$$

heißt verallgemeinerte Lösung der Aufgabe A, wenn die Integralidentitäten

$$\int_Q \{\bar{v}(\bar{\psi}_t + (\bar{v} \cdot \nabla)\bar{\psi}) - D(\bar{v}) : D(\bar{\psi})\} d\bar{x} dt = - \int_\Omega \bar{v}_0 \cdot \bar{\psi}_0 d\bar{x}, \quad (1.6)$$

$$\int_Q \varphi(\eta_t + \bar{v} \cdot \nabla \eta) d\bar{x} dt = - \int_\Omega \varphi_0 \eta_0 d\bar{x} \quad (1.7)$$

für beliebige Funktionen $\eta \in C^1(Q)$, $\eta(T) = 0$, $\bar{\psi} \in H^1(Q) \cap L_2(0, T; K(\varphi))$, $\bar{\psi}(T) = 0$ gelten.

BEMERKUNG. Wir charakterisieren den Festkörper durch die Bedingung, daß $D(\bar{v})(\bar{x}) = 0$ für $\bar{x} \in S(\varphi)$. Das ist folgendermaßen motiviert. Der Kern des Operators D besteht aus Funktionen, die die Form $\bar{v} = \bar{a} + \bar{\omega} \times \bar{x}$, $\bar{a}, \bar{\omega} \in R^3$, haben ([5], S.18). Damit bewegt sich die Flüssigkeit wie ein Festkörper. Deshalb nennen wir solche Funktionen auch "starre" Funktionen.

Das Hauptergebnis dieser Arbeit ist der folgende Satz.

SATZ 1. Sei $\bar{v}_0 \in L_2(\Omega)$. Wenn Ω und $S(\varphi_0)$ Kugeln in R^3 sind, hat die Aufgabe A mindestens eine verallgemeinerte Lösung.

Außerdem gelten:

1. Es gibt eine Familie von Abbildungen $A_{s,t} : R^3 \rightarrow R^3$, $s, t \in [0, T]$, so daß $S(\varphi(t)) = A_{s,t}(S(\varphi(s)))$ (und $S(\varphi(t)) = A_{0,t}(S(\varphi_0))$), $A_{s,t}(\bar{x})$ ist "starr" (im Sinne obiger Bemerkung), und $A_{s,t}$ Lipschitz-stetig bezüglich s und t ist.

2. Wenn $h(t) = \text{dist}(\partial\Omega, S(\varphi(t)))$ und $h(t_0) = 0$ für $t_0 \in [0, T]$, so gilt $\lim_{t \rightarrow t_0} h(t)|t - t_0|^{-1} = 0$.

3. Für fast alle $t \in \{t \in [0, T] \mid h(t) = 0\}$ weist $\bar{\omega}(t)$ in Richtung von \bar{n}_M , und es gilt $\bar{v}_M = 0$. Ferner sind $M = \partial\Omega \cap \partial S(\varphi(t))$ ein Punkt, \bar{v}_M die Geschwindigkeit des Punktes des Körpers, der mit M übereinstimmt, und \bar{n}_M die Normale der Fläche $\partial S(\varphi(t))$ (und $\partial\Omega$) in M .

BEMERKUNG. Die zweite Behauptung des Satzes bedeutet, daß der Festkörper die Wand mit Geschwindigkeit Null erreicht.

2 DER RAUM $K(\chi)$.

Hier untersuchen wir Eigenschaften der Funktionen, die zum Raum $K(\chi)$ gehören. Es wird immer angenommen, daß Ω und $S(\chi)$ Kugeln sind, und 0 der Mittelpunkt von Ω ist.

Es sei $\{A_s\}$ eine Familie von Abbildungen $A_s : R^3 \rightarrow R^3$, die die Form

$$A_s(\bar{x}) = \bar{a}(s) + B(s) < \bar{x} > \quad (2.1)$$

haben, wobei $\bar{a} : R \rightarrow R^3$, $B : R \rightarrow R^3 \times R^3$ glatte Funktionen sind, $B(s)$ für jedes s eine lineare orthogonale Abbildung ist, und $\bar{a}(0) = 0$, $B(0) = I$ gilt.

SATZ 2. Es seien χ die charakteristische Funktion einer Kugel $S(\chi) \subset \Omega$ und $\chi_s(\bar{x}) = \chi(A_s^{-1}(\bar{x}))$, $s \geq 0$, d.h. $S(\chi_s) = A(S(\chi))$. Wenn $S(\chi_s) \subset \Omega$ für jedes $s \in [0, s_0]$, $s_0 > 0$, gilt, dann konvergiert $K(\chi_s) \rightarrow K(\chi)$ für $s \rightarrow 0$ in $H_0^1(\Omega)$, d.h. für jede Funktion $\bar{\psi} \in K(\chi)$ gibt es eine Folge von Funktionen $\bar{\psi}_s \in K(\chi_s)$ mit $\bar{\psi}_s \rightarrow \bar{\psi}$ in $H_0^1(\Omega)$.

BEWEIS. Weil $S(\chi)$ eine Kugel ist, gibt es viele Abbildungen der Art (2.1), die $S(\chi)$ auf $S(\chi_s)$ abbilden. Wir nehmen ein solches A_s , so daß $|\bar{a}(s)|$ minimal ist. Es sei $\bar{\psi}$ eine Funktion aus $K(\chi)$. Wir müssen eine Folge von Funktionen $\bar{\psi}_s \in K(\chi_s)$ konstruieren, die gegen $\bar{\psi}$ in $H_0^1(\Omega)$ konvergiert. Zuerst konstruieren wir eine Folge von Funktionen $\bar{\zeta}_s = B(s) < \bar{\psi}(B^{-1}(s) < \bar{x} >) >$. Es ist klar, daß $\bar{\zeta}_s \in K(\eta_s)$ ist, und $\bar{\zeta}_s$ gegen $\bar{\psi}$ in $H_0^1(\Omega)$ für $s \rightarrow 0$ konvergiert, wobei $\eta_s(\bar{x}) = \chi(B^{-1}(s) < \bar{x} >)$ ist. Jetzt haben wir nur zu beweisen, daß eine Folge von Funktionen $\bar{\xi}_s \in K(\mu_s)$ existiert, wobei $\mu_s(\bar{x}) = \chi(\bar{x} - \bar{a}(s))$, die gegen $\bar{\psi}$ in $H_0^1(\Omega)$ konvergiert. Wir merken an, daß der Vektor \bar{a} in Richtung des Radius von Ω zeigt.

Es sei \bar{u} die "starre" Funktion, die mit $\bar{\psi}$ in $S(\chi)$ übereinstimmt. Wir nehmen $\bar{\xi}_s$ als die Lösung der folgenden Aufgabe:

$$\begin{aligned} \Delta \bar{\xi}_s &= \nabla q_s + \Delta \bar{\psi}, & \bar{x} \in \Omega \setminus S(\mu_s) \\ \operatorname{div} \bar{\xi}_s &= 0, \end{aligned}$$

$$\bar{\xi}_s(\bar{x}) = \begin{cases} 0, & \bar{x} \in \partial\Omega, \\ \bar{u}(\bar{x}), & \bar{x} \in \partial S(\mu_s). \end{cases}$$

Es ist nicht schwer zu sehen, daß $\bar{\xi}_s$ gegen $\bar{\psi}$ in $H_0^1(\Omega)$ konvergiert. Wenn nämlich $|\bar{a}(s)| \neq 0$, haben wir [6]:

$$\|\bar{\psi} - \bar{\xi}_s\|_{H^1(\Omega \setminus S(\mu_s))} \leq C \|\bar{\psi} - \bar{u}\|_{H^{1/2}(\partial S(\mu_s))}. \quad (2.2)$$

Aber mit dem Spursatz ([6], [7]) gilt die Abschätzung

$$\|\bar{\psi} - \bar{u}\|_{H^{1/2}(\partial S(\mu_s))} \leq C \|\bar{\psi} - \bar{u}\|_{H^1(S(\mu_s))} = C \|\bar{\psi} - \bar{u}\|_{H^1(S(\mu_s) \setminus S(\chi))}$$

mit einer von s unabhängigen Konstante C . Somit,

$$\begin{aligned} \|\bar{\psi} - \bar{\xi}_s\|_{H^1(\Omega)} &= \|\bar{\psi} - \bar{\xi}_s\|_{H^1(\Omega \setminus (S(\mu_s) \cap S(\chi)))} \leq \\ &\leq \|\bar{\psi} - \bar{\xi}_s\|_{H^1(\Omega \setminus S(\mu_s))} + \|\bar{\psi} - \bar{\xi}_s\|_{H^1(S(\mu_s) \setminus S(\chi))} \leq \\ &\leq C \|\bar{\psi} - \bar{\xi}_s\|_{H^1(S(\mu_s) \setminus S(\chi))}. \end{aligned}$$

Die rechte Seite dieser Ungleichung konvergiert aber für $s \rightarrow 0$ gegen Null, weil $|S(\mu_s) \setminus S(\chi)| \rightarrow 0$ gilt.

Damit ist der Satz bewiesen.

Jetzt untersuchen wir Eigenschaften der Funktionen aus $K(\chi)$, wenn der Festkörper (die Festkugel) die Wand berührt.

SATZ 3. Es seien $\bar{\psi} \in K(\chi)$ und $\partial S(\chi) \cap \partial\Omega \neq \emptyset$. Dann gelten

1. $\bar{\psi}(M) = 0$, wobei M der Punkt des Körpers ist, der mit $\partial S(\chi) \cap \partial\Omega$ übereinstimmt.
2. $\bar{\psi}(\bar{x})$ ist orthogonal zu \bar{n}_M für alle $\bar{x} \in S(\chi)$, wobei \bar{n}_M die Normale an $\partial\Omega$ im Punkt M ist.

BEMERKUNG. Der erste Punkt des Satzes kann schärfer formuliert werden. Nämlich, es gilt

$$\lim_{\rho \rightarrow 0} |R_\rho|^{-1} \int_{R_\rho} |\bar{\psi}(\bar{x})| d\bar{x} = 0,$$

wobei $R_\rho = \{\bar{x} \in S(\chi) \mid \text{dist}(\bar{x}, M) \leq \rho\}$.

BEWEIS DES SATZES 3. Es sei $\xi = (\xi_1, \xi_2, \xi_3)$ ein solches orthogonales Koordinatensystem, so daß $(0, 0, 0) = M$, und der Vektor $(0, 0, 1)$ in Richtung von \bar{n}_M zeigt. Nehmen wir an, daß $\partial\Omega$ bzw. $\partial S(\chi)$ durch Funktionen g bzw. f beschrieben werden, d.h.

$$\partial\Omega = \{\bar{\xi} \in R^3 \mid \xi_3 = g(\xi_1, \xi_2)\},$$

bzw.

$$\partial S(\chi) = \{\bar{\xi} \in R^3 \mid \xi_3 = f(\xi_1, \xi_2)\}.$$

Es sei $L_\rho = \{(\xi_1, \xi_2) \in R^2 \mid f(\xi_1, \xi_2) \leq \rho\}$. Dann gilt:

$$\begin{aligned} \int_{L_\rho} |\bar{\psi}(\xi_1, \xi_2, \rho)|^2 d\xi_1 d\xi_2 &= \int_{L_\rho} |\bar{\psi}(\xi_1, \xi_2, \rho) - \bar{\psi}(\xi_1, \xi_2, 0)|^2 d\xi_1 d\xi_2 = \\ &= \int_{L_\rho} \left| \int_0^\rho \frac{\partial \bar{\psi}}{\partial \xi_3} d\xi_3 \right|^2 d\xi_1 d\xi_2 \leq C\rho \int_{L_\rho} \int_0^\rho |\nabla \bar{\psi}|^2 d\xi_1 d\xi_2 d\xi_3, \end{aligned}$$

wobei $\bar{\psi}$ mit Null außerhalb Ω fortgesetzt wird. Es gilt aber $|L_\rho| \geq C\rho$. Daher erhalten wir die Beziehung

$$\lim_{\rho \rightarrow 0} |L_\rho|^{-1} \int_{L_\rho} |\bar{\psi}|^2 d\xi_1 d\xi_2 \leq C \lim_{\rho \rightarrow 0} \int_{L_\rho} \int_0^\rho |\nabla \bar{\psi}|^2 d\xi_1 d\xi_2 d\xi_3 = 0,$$

und der erste Punkt des Satzes ist bewiesen.

Nun seien $G_\rho^\alpha = \{\bar{\xi} \in R^3 \mid (\xi_1, \xi_2) \in L_\rho, g(\xi_1, \xi_2) \leq \xi_3 \leq f(\xi_1, \xi_2), \xi_1 \leq \alpha\xi_2\}$ für $\alpha \in R$, $F_\rho^\alpha = \partial G_\rho^\alpha \cap \partial S(\chi)$, $W_\rho^\alpha = \partial G_\rho^\alpha \cap \partial\Omega$ und $V_\rho^\alpha = \partial G_\rho^\alpha \setminus (F_\rho^\alpha \cup W_\rho^\alpha)$. Weil $\text{div} \bar{\psi} = 0$ ist, haben wir

$$\int_{\partial G_\rho^\alpha} \bar{\psi} \cdot \bar{n} ds = 0,$$

und folglich

$$\int_{F_\rho^\alpha} \bar{\psi} \cdot \bar{n} ds + \int_{V_\rho^\alpha} \bar{\psi} \cdot \bar{n} ds = 0.$$

Aber $\bar{\psi}$ hat die Darstellung

$$\bar{\psi}(\bar{\xi}) = \bar{\omega} \times \bar{\xi}$$

für $\bar{\xi} \in S(\chi)$, wobei $\bar{\omega}$ ein von $\bar{\xi}$ unabhängiger Vektor ist. Deshalb gilt

$$|\bar{\omega} \cdot \int_{F_\rho^\alpha} \bar{\xi} \times \bar{n} ds| \leq \int_{V_\rho^\alpha} |\bar{\psi}| ds. \quad (2.3)$$

Wir merken an, daß $\int_{F_\rho^\alpha} \bar{\xi} \times \bar{n} ds = k(\rho) \bar{\tau}_\alpha$ ist, wobei $\bar{\tau}_\alpha$ ein von ρ unabhängiger

Tangentialvektor an die Fläche $\partial\Omega$ im Punkt M ist, und $k(\rho) \geq C\rho^{3/2}$ gilt.

Die Integration der Ungleichung (2.3) von 0 bis $\sigma > 0$ bezüglich ρ ergibt

$$\begin{aligned} \sigma^{5/2} |\bar{\omega} \cdot \bar{\tau}_\alpha| &\leq \int_{G_\sigma^\alpha} |\bar{\psi}| d\bar{\xi} \leq |G_\sigma^\alpha|^{1/2} \left(\int_{G_\sigma^\alpha} |\bar{\psi}|^2 d\bar{\xi} \right)^{1/2} = \\ &= |G_\sigma^\alpha|^{1/2} \left(\int_0^\sigma \int_{G_\sigma^\alpha(\xi_3)} |\bar{\psi}|^2 d\xi_1 d\xi_2 d\xi_3 \right)^{1/2}, \end{aligned} \quad (2.4)$$

wobei $G_\sigma^\alpha(s)$ die Menge $\{\bar{\xi} \in G_\sigma^\alpha \mid \xi_3 = s\}$ bezeichnet. Aber es ist $|G_\sigma^\alpha| \leq C\sigma^2$, und, weil $\bar{\psi}$ gleich Null auf $\partial\Omega$ ist, gilt die Abschätzung

$$\int_{G_\sigma^\alpha(\xi_3)} |\bar{\psi}|^2 d\xi_1 d\xi_2 \leq C \|\nabla \bar{\psi}\|_{L_2(\Omega)}^2 |\xi_3|.$$

So erhalten wir aus (2.4):

$$|\bar{\omega} \cdot \bar{\tau}_\alpha| \leq C\sigma^{1/2}.$$

Weil σ eine beliebige Zahl war, ist $\bar{\omega} \cdot \bar{\tau}_\alpha = 0$ für alle $\alpha \in R$, und folglich zeigt $\bar{\omega}$ in Richtung von \bar{n}_M .

Damit ist der Satz bewiesen.

3 BEWEIS DES SATZES 1.

Die Lösbarkeit der Aufgabe A und die erste Behauptung des Satzes können genau wie in [4] bewiesen werden. Für die Lösung gilt die folgende Abschätzung:

$$\int_\Omega |\bar{v}(\bar{x}, t)|^2 d\bar{x} + \int_0^t \int_\Omega |\nabla \bar{v}(\bar{x}, s)|^2 d\bar{x} ds \leq \int_\Omega |\bar{v}_0(\bar{x})|^2 d\bar{x}. \quad (3.1)$$

Das heißt $\bar{v} \in H_0^1(\Omega)$ für fast alle $t \in [0, T]$, und die Behauptung 3 des Satzes ergibt sich aus dem Satz 3. Es bleibt noch die Behauptung 2 zu beweisen.

Wie in [4] (Aussage 3.4) können wir die Abschätzung

$$\left| \frac{dh(t)}{dt} \right| \leq Ch^{1/2}(t)(z(t) + 1)$$

herleiten, wobei $z(t) = \|\nabla \bar{v}(t)\|_{L_2(\Omega)}$ ist. Wenn $h(t_0) = 0$ für ein $t_0 \in [0, T]$ ist, gibt uns die Integration dieser Ungleichung:

$$h^{1/2}(t) \leq C \left| \int_{t_0}^t (z(s) + 1) ds \right| \leq C |t - t_0|^{1/2} \left(\int_{t_0}^t (z(s) + 1)^2 ds \right)^{1/2}.$$

Weil die Funktion z zu $L_2(0, T)$ gehört, ist die Behauptung bewiesen.

LITERATUR

- [1] N. V. Yudakov. *On the solvability of the problem on the motion of a solid body in a viscous incompressible fluid*. Dinamika Sploshnoi Sredy, 1974, v.18, s.249-253.
- [2] D. Serre. *Chute Libre d'un Solide dans un Fluide Visqueux Incompressible. Existence*. Japan Journal of Applied Mathematics, 1987, v.4, N1, pp.99-110.
- [3] R. Hsu, P. Ganatos. *The motion of a rigid body in viscous fluid bounded by a plane wall*. Journal of Fluid Mechanics, 1989, v.207, pp.29-72.
- [4] K.-H. Hoffmann, V.N.Starovoitov. *On a motion of a solid body in a viscous fluid. Two-dimensional case*. Advances in Mathematical Sciences and Applications, 1999, v.9, N 2, pp.633-648.
- [5] R. Temam. *Mathematical problems in plasticity*. 1985, BORDAS, Paris.
- [6] R. Temam. *Navier-Stokes Equations. Theory and Numerical Analysis*. 1977, North-Holland Pub. Co., Amsterdam - New York - Tokyo.
- [7] J. L. Lions, E.Magenes. *Non-homogeneous Boundary Value Problems and Applications*. Volume I. 1972, Springer, Berlin.

Karl-Heinz Hoffmann
 Institut für Angewandte
 Mathematik und Statistik,
 Technische Universität
 München, Deutschland
 hoffmann@caesar.de

Victor N. Starovoitov
 Lavrentyev Institut für
 Hydrodynamik,
 Novosibirsk, 630090
 Rußland
 star@hydro.nsc.ru

THE ABEL–JACOBI MAP FOR A CUBIC THREEFOLD
AND PERIODS OF FANO THREEFOLDS OF DEGREE 14

A. ILIEV AND D. MARKUSHEVICH

Received: October 15, 1999

Revised: January 17, 2000

Communicated by Thomas Peternell

ABSTRACT. The Abel–Jacobi maps of the families of elliptic quintics and rational quartics lying on a smooth cubic threefold are studied. It is proved that their generic fiber is the 5-dimensional projective space for quintics, and a smooth 3-dimensional variety birational to the cubic itself for quartics. The paper is a continuation of the recent work of Markushevich–Tikhomirov, who showed that the first Abel–Jacobi map factors through the moduli component of stable rank 2 vector bundles on the cubic threefold with Chern numbers $c_1 = 0, c_2 = 2$ obtained by Serre’s construction from elliptic quintics, and that the factorizing map from the moduli space to the intermediate Jacobian is étale. The above result implies that the degree of the étale map is 1, hence the moduli component of vector bundles is birational to the intermediate Jacobian. As an application, it is shown that the generic fiber of the period map of Fano varieties of degree 14 is birational to the intermediate Jacobian of the associated cubic threefold.

1991 Mathematics Subject Classification: 14J30, 14J60, 14J45

INTRODUCTION

Clemens and Griffiths studied in [CG] the Abel–Jacobi map of the family of lines on a cubic threefold X . They represented its intermediate Jacobian $J^2(X)$ as the Albanese variety $\text{Alb } F(X)$ of the Fano surface $F(X)$ parametrizing lines on X and described its theta divisor. From this description, they deduced the Torelli Theorem and the non-rationality of X . Similar results were obtained by Tyurin [Tyu] and Beauville [B].

One can easily understand the structure of the Abel–Jacobi maps of some other families of curves of low degree on X (conics, cubics or elliptic quartics), in reducing the problem to the results of Clemens–Griffiths and Tyurin. The first non trivial cases are those of rational normal quartics and of elliptic normal

quintics. We determine the fibers of the Abel–Jacobi maps of these families of curves, in continuing the work started in [MT].

Our result on elliptic quintics implies that the moduli space of instanton vector bundles of charge 2 on X has a component, birational to $J^2(X)$. We conjecture that the moduli space is irreducible, but the problem of irreducibility stays beyond the scope of the present article. As far as we know, this is the first example of a moduli space of vector bundles which is birational to an abelian variety, different from the Picard or Albanese variety of the base. The situation is also quite different from the known cases where the base is \mathbb{P}^3 or the 3-dimensional quadric. In these cases, the instanton moduli space is irreducible and rational at least for small charges, see [Barth], [ES], [H], [LP], [OS]. Remark, that for the cubic X , two is the smallest possible charge, but the moduli space is not even unirational. There are no papers on the geometry of particular moduli spaces of vector bundles for other 3-dimensional Fano varieties (for some constructions of vector bundles on such varieties, see [G1], [G2], [B-MR1], [B-MR2], [SW], [AC]).

The authors of [MT] proved that the Abel–Jacobi map Φ of the family of elliptic quintics lying on a general cubic threefold X factors through a 5-dimensional moduli component M_X of stable rank 2 vector bundles \mathcal{E} on X with Chern numbers $c_1 = 0, c_2 = 2$. The factorizing map ϕ sends an elliptic quintic $C \subset X$ to the vector bundle \mathcal{E} obtained by Serre’s construction from C (see Sect. 2). The fiber $\phi^{-1}([\mathcal{E}])$ is a 5-dimensional projective space in the Hilbert scheme Hilb_X^{5n} , and the map Ψ from the moduli space to the intermediate Jacobian $J^2(X)$, defined by $\Phi = \Psi \circ \phi$, is étale on the open set representing (smooth) elliptic quintics which are not contained in a hyperplane (Theorem 2.1).

We improve the result of [MT] in showing that the degree of the above étale map is 1. Hence M_X is birational to $J^2(X)$ and the generic fiber of Φ is just one copy of \mathbb{P}^5 (see Theorem 3.2 and Corollary 3.3). The behavior of the Abel–Jacobi map of elliptic quintics is thus quite similar to that of the Abel–Jacobi map of divisors on a curve, where all the fibers are projective spaces. But we prove that the situation is very different in the case of rational normal quartics, where the fiber of the Abel–Jacobi map is a *non-rational* 3-dimensional variety: it is birationally equivalent to the cubic X itself (Theorem 5.2).

The first new ingredient of our proofs, comparing to [MT], is another interpretation of the vector bundles \mathcal{E} from M_X . We represent the cubic X as a linear section of the Pfaffian cubic in \mathbb{P}^{14} , parametrizing 6×6 matrices M of rank 4, and realize $\mathcal{E}^\vee(-1)$ as the restriction of the kernel bundle $M \mapsto \ker M \subset \mathbb{C}^6$ (Theorem 2.2). The kernel bundle has been investigated by A. Adler in his Appendix to [AR]. We prove that it embeds X into the Grassmannian $G = G(2, 6)$, and the quintics $C \in \phi^{-1}([\mathcal{E}])$ become the sections of X by the Schubert varieties $\sigma_{11}(L)$ for all hyperplanes $L \subset \mathbb{C}^6$. We deduce that for any line $l \subset X$, each fiber of ϕ contains precisely one pencil \mathbb{P}^1 of reducible curves of the form $C' + l$ (Lemma 3.4). Next we use the techniques of Hartshorne–Hirschowitz [HH] for smoothing the curves of the type “a rational normal quartic plus one of its chords in X ” (see Sect. 4) to show that there is a 3-dimensional family

of such curves in a generic fiber of ϕ and that the above pencil \mathbb{P}^1 for a generic l contains curves $C' + l$ of this type (Lemma 4.6, Corollary 4.7).

The other main ingredient is the parametrization of $J^2(X)$ by minimal sections of the 2-dimensional conic bundles of the form $Y(C^2) = \pi_l^{-1}(C^2)$, where $\pi_l : \text{Blowup}_l(X) \rightarrow \mathbb{P}^2$ is the conic bundle obtained by projecting X from a fixed line l , and C^2 is a generic conic in \mathbb{P}^2 (see Sect. 3). The standard Wirtinger approach [B] parametrizes $J^2(X)$ by reducible curves which are sums of components of reducible fibers of π_l . Our approach, developed in [I] in a more general form, replaces the degree 10 sums of components of the reducible fibers of the surfaces $Y(C^2)$ by the irreducible curves which are sections of the projection $Y(C^2) \rightarrow C^2$ with a certain minimality condition. This gives a parametrization of $J^2(X)$ by a family of rational curves, each one of which is projected isomorphically onto some conic in \mathbb{P}^2 . It turns out, that these rational curves are normal quartics meeting l at two points. They form a *unique* pencil \mathbb{P}^1 in each fiber of the Abel–Jacobi map of rational normal quartics. Combining this with the above, we conclude that the curves of type $C' + l$ form a unique pencil in each fiber of Φ , hence the fiber is one copy of \mathbb{P}^5 .

In conclusion, we provide a description of the moduli space of Fano varieties V_{14} as a birationally fibered space over the moduli space of cubic 3-folds with the intermediate Jacobian as a fiber (see Theorem 5.8). The interplay between cubics and varieties V_{14} is exploited several times in the paper. We use the Fano–Iskovskikh birationality between X and V_{14} to prove Theorem 2.2 on kernel bundles, and the Tregub–Takeuchi one (see Sect. 1) to study the fiber of the Abel–Jacobi map of the family of rational quartics (Theorem 5.2) and the relation of this family to that of normal elliptic quintics (Proposition 5.6).

Acknowledgements. The authors are grateful to the referee for his remarks which allowed to improve the exposition. The second author acknowledges with pleasure the hospitality of the MPIM at Bonn, where he completed the work on the paper.

1. BIRATIONAL ISOMORPHISMS BETWEEN V_3 AND V_{14}

There are two constructions of birational isomorphisms between a nonsingular cubic threefold $V_3 \subset \mathbb{P}^4$ and the Fano variety V_{14} of degree 14 and of index 1, which is a nonsingular section of the Grassmannian $G(2, 6) \subset \mathbb{P}^{14}$ by a linear subspace of codimension 5. The first one is that of Fano–Iskovskikh, and it gives a birational isomorphism whose indeterminacy locus in both varieties is an elliptic curve together with some 25 lines; the other is due to Tregub–Takeuchi, and its indeterminacy locus is a rational quartic plus 16 lines on the side of V_3 , and 16 conics passing through one point on the side of V_{14} . We will sketch both of them.

THEOREM 1.1 (Fano–Iskovskikh). *Let $X = V_3$ be a smooth cubic threefold. Then X contains a smooth projectively normal elliptic quintic curve. Let C be such a curve. Then C has exactly 25 bisecant lines $l_i \subset X$, $i = 1, \dots, 25$, and*

there is a unique effective divisor $M \in |\mathcal{O}_X(5 - 3C)|$ on X , which is a reduced surface containing the l_i . The following assertions hold:

(i) The non-complete linear system $|\mathcal{O}_X(7 - 4C)|$ defines a birational map $\rho : X \rightarrow V$ where $V = V_{14}$ is a Fano 3-fold of index 1 and of degree 14. Moreover $\rho = \sigma \circ \kappa \circ \tau$ where $\sigma : X' \rightarrow X$ is the blow-up of C , $\kappa : X' \rightarrow X^+$ is a flop over the proper transforms $l'_i \subset X'$ of the l_i , $i = 1, \dots, 25$, and $\tau : X^+ \rightarrow V$ is a blowdown of the proper transform $M^+ \subset X^+$ of M onto an elliptic quintic $B \subset V$. The map τ sends the transforms $l_i^+ \subset X^+$ of l_i to the 25 secant lines $m_i \subset V$, $i = 1, \dots, 25$ of the curve B .

(ii) The inverse map ρ^{-1} is defined by the system $|\mathcal{O}_V(3 - 4B)|$. The exceptional divisor $E' = \sigma^{-1}(C) \subset X'$ is the proper transform of the unique effective divisor $N \in |\mathcal{O}_V(2 - 3B)|$.

For a proof, see [Isk1], [F], or [Isk-P], Ch. 4.

THEOREM 1.2 (Tregub–Takeuchi). *Let X be a smooth cubic threefold. Then X contains a rational projectively normal quartic curve. Let Γ be such a curve. Then Γ has exactly 16 bisecant lines $l_i \subset X$, $i = 1, \dots, 16$, and there is a unique effective divisor $M \in |\mathcal{O}_X(3 - 2\Gamma)|$ on X , which is a reduced surface containing the l_i . The following assertions hold:*

(i) The non-complete linear system $|\mathcal{O}_X(8 - 5\Gamma)|$ defines a birational map $\chi : X \rightarrow V$ where V is a Fano 3-fold of index 1 and of degree 14. Moreover $\chi = \sigma \circ \kappa \circ \tau$, where $\sigma : X' \rightarrow X$ is the blowup of Γ , $\kappa : X' \rightarrow X^+$ is a flop over the proper transforms $l'_i \subset X'$ of l_i , $i = 1, \dots, 16$, and $\tau : X^+ \rightarrow V$ is a blowdown of the proper transform $M^+ \subset X^+$ of M to a point $P \in V$. The map τ sends the transforms $l_i^+ \subset X^+$ of l_i to the 16 conics $q_i \subset V$, $i = 1, \dots, 16$ which pass through the point P .

(ii) The inverse map χ^{-1} is defined by the system $|\mathcal{O}_V(2 - 5P)|$. The exceptional divisor $E' = \sigma^{-1}(\Gamma) \subset X'$ is the proper transform of the unique effective divisor $N \in |\mathcal{O}_V(3 - 8P)|$.

(iii) For a generic point P on any nonsingular V_{14} , this linear system defines a birational isomorphism of type χ^{-1} .

Proof. For (i), (ii), see [Tak], Theorem 3.1, and [Tre]. For (iii), see [Tak], Theorem 2.1, (iv). See also [Isk-P], Ch. 4. \square

1.3. GEOMETRIC DESCRIPTION. We will briefly describe the geometry of the first birational isomorphism between V_3 and V_{14} following [P].

Let E be a 6-dimensional vector space over \mathbb{C} . Fix a basis e_0, \dots, e_5 for E , then $e_i \wedge e_j$ for $0 \leq i < j \leq 5$ form a basis for the Plücker space of 2-spaces in E , or equivalently, of lines in $\mathbb{P}^5 = \mathbb{P}(E)$. With Plücker coordinates x_{ij} , the embedding of the Grassmannian $G = G(2, E)$ in $\mathbb{P}^{14} = \mathbb{P}(\wedge^2 E)$ is precisely the

locus of rank 2 skew symmetric 6×6 matrices

$$M = \begin{bmatrix} 0 & x_{01} & x_{02} & x_{03} & x_{04} & x_{05} \\ -x_{01} & 0 & x_{12} & x_{13} & x_{14} & x_{15} \\ -x_{02} & -x_{12} & 0 & x_{23} & x_{24} & x_{25} \\ -x_{03} & -x_{13} & -x_{23} & 0 & x_{34} & x_{35} \\ -x_{04} & -x_{14} & -x_{24} & -x_{34} & 0 & x_{45} \\ -x_{05} & -x_{15} & -x_{25} & -x_{35} & -x_{45} & 0 \end{bmatrix}.$$

There are two ways to associate to these data a 13-dimensional cubic. The Pfaffian cubic hypersurface $\Xi \subset \mathbb{P}^{14}$ is defined as the zero locus of the 6×6 Pfaffian of this matrix; it can be identified with the secant variety of $G(2, E)$, or else, it is the locus where M has rank 4. The other way is to consider the dual variety $\Xi' = G^\vee \subset \mathbb{P}^{14^\vee}$ of G ; it is also a cubic hypersurface, which is nothing other than the secant variety of the Grassmannian $G' = G(2, E^\vee) \subset \mathbb{P}(\wedge^2 E^\vee) = \mathbb{P}^{14^\vee}$.

As it is classically known, the generic cubic threefold X can be represented as a section of the Pfaffian cubic by a linear subspace of codimension 10; see also a recent proof in [AR], Theorem 47.3. There are ∞^5 essentially different ways to do this. Beauville and Donagi [BD] have used this idea for introducing the symplectic structure on the Fano 4-fold (parametrizing lines) of a cubic 4-fold. In their case, only special cubics (a divisorial family) are sections of the Pfaffian cubic, so they introduced the symplectic structure on the Fano 4-folds of these special cubics, and obtained the existence of such a structure on the generic one by deformation arguments.

For any hyperplane section $H \cap G$ of G , we can define $\text{rk } H$ as the rank of the antisymmetric matrix (α_{ij}) , where $\sum \alpha_{ij} x_{ij} = 0$ is the equation of H . So, $\text{rk } H$ may take the values 2, 4 or 6. If $\text{rk } H = 6$, then $H \cap G$ is nonsingular and for any $p \in \mathbb{P}^5 = \mathbb{P}(E)$, there is the unique hyperplane $L_p \subset \mathbb{P}^5 = \mathbb{P}(E)$, such that $q \in H \cap G$, $p \in l_q \iff l_q \subset L_p$. Here l_q denotes the line in \mathbb{P}^5 represented by $q \in G$. (This is a way to see that the base of the family of 3-dimensional planes on the 7-fold $H \cap G$ is \mathbb{P}^5 .)

The rank of H is 4 if and only if H is tangent to G at exactly one point z , and in this case, the hyperplane L_p is not defined for any $p \in l_z$: we have for such p the equivalence $p \in l_x \iff x \in H$. Following Puts, we call the line l_z the *center* of H ; it will be denoted c_H .

In the third case, when $\text{rk } H = 2$, $H \cap G$ is singular along the whole Grassmannian subvariety $G(2, 4) = G(2, E_H)$, where $E_H = \ker(\alpha_{ij})$ is of dimension 4. We have $x \in H \iff l_x \cap \mathbb{P}(E_H) \neq \emptyset$.

This description identifies the dual of G with $\Xi' = \{H \mid \text{rk } H \leq 4\} = \{H \mid \text{Pf}((\alpha_{ij})) = 0\}$, and its singular locus with $\{E_H\}_{\text{rk } H=2} = G(4, E)$.

Now, associate to any nonsingular $V_{14} = G \cap \Lambda$, where $\Lambda = H_1 \cap H_2 \cap H_3 \cap H_4 \cap H_5$, the cubic 3-fold V_3 by the following rule:

$$(1) \quad V_{14} = G \cap \Lambda \mapsto V_3 = \Xi' \cap \Lambda^\vee,$$

where $\Lambda^\vee = \langle H_1^\vee, H_2^\vee, H_3^\vee, H_4^\vee, H_5^\vee \rangle$, H_i^\vee denotes the orthogonal complement of H_i in $\mathbb{P}^{14\vee}$, and the angular brackets the linear span. One can prove that V_3 is also nonsingular.

According to Fano, the lines l_x represented by points $x \in V_{14}$ sweep out an irreducible quartic hypersurface W , which Fano calls the quartic da Palatini. W coincides with the union of centers of all $H \in V_3$. One can see, that W is singular along the locus of foci p of Schubert pencils of lines on G

$$\sigma_{43}(p, h) = \{x \in G \mid p \in l_x \subset h\}$$

which lie entirely in V_{14} , where h denotes a plane in \mathbb{P}^5 (depending on p). The pencils σ_{43} are exactly the lines on V_{14} , so $\text{Sing } W$ is identified with the base of the family of lines on V_{14} , which is known to be a nonsingular curve of genus 26 for generic V_{14} (see, e. g. [M] for the study of the curve of lines on V_{14} , and Sections 50, 51 of [AR] for the study of $\text{Sing } W$ without any connection to V_{14}).

The construction of the birational isomorphism $\eta_L : V_{14} \dashrightarrow V_3$ depends on the choice of a hyperplane $L \subset \mathbb{P}^5$. Let

$$\phi : V_{14} \dashrightarrow W \cap L, \quad x \mapsto L \cap l_x, \quad \psi : V_3 \dashrightarrow W \cap L, \quad H^\vee \mapsto L \cap c_H.$$

These two maps are birational, and η_L is defined by

$$(2) \quad \eta_L = \psi^{-1} \circ \phi.$$

The locus, on which η_L is not an isomorphism, consists of points where either ϕ or ψ is not defined or is not one-to-one. The indeterminacy locus B of ϕ consists of all the points x such that $l_x \subset L$, that is, $B = G(2, L) \cap H_1 \cap \dots \cap H_5$. For generic L , it is obviously a smooth elliptic quintic curve in V_{14} , and it is this curve that was denoted in Theorem 1.1 by the same symbol B . The indeterminacy locus of ψ is described in a similar way. We summarize the above in the following statement.

PROPOSITION 1.4. *Any nonsingular variety V_{14} determines a unique nonsingular cubic V_3 by the rule (1). Conversely, a generic cubic V_3 can be obtained in this way from ∞^5 many varieties V_{14} .*

For each pair (V_{14}, V_3) related by (1), there is a family of birational maps $\eta_L : V_{14} \dashrightarrow V_3$, defined by (2) and parametrized by points of the dual projective space $\mathbb{P}^{5\vee}$, and the structure of η_L for generic L is described by Theorem 1.1. The smooth elliptic quintic curve B (resp. C) of Theorem 1.1 is the locus of points $x \in V_{14}$ such that $l_x \subset L$ (resp. $H^\vee \in V_3$ such that $c_H \subset L$).

DEFINITION 1.5. We will call two varieties V_3, V_{14} associated (to each other), if V_3 can be obtained from V_{14} by the construction (1).

1.6. INTERMEDIATE JACOBIANS OF V_3, V_{14} . Both constructions of birational isomorphisms give the isomorphism of the intermediate Jacobians of generic varieties V_3, V_{14} , associated to each other. This is completely obvious for the second construction: it gives a birational isomorphism, which is a composition of blowups and blowdowns with centers in nonsingular rational curves or

points. According to [CG], a blowup $\sigma : \tilde{X} \rightarrow X$ of a threefold X with a nonsingular center Z can change its intermediate Jacobian only in the case when Z is a curve of genus ≥ 1 , and in this case $J^2(\tilde{X}) \simeq J^2(X) \times J(Z)$ as principally polarized abelian varieties, where J^2 (resp. J) stands for the intermediate Jacobian of a threefold (resp. for the Jacobian of a curve). Thus, the Tregub–Takeuchi birational isomorphism does not change the intermediate Jacobian. Similar argument works for the Fano–Iskovskikh construction. It factors through blowups and blowdowns with centers in rational curves, and contains in its factorization exactly one blowup and one blowdown with nonrational centers, which are elliptic curves. So, we have $J^2(V_3) \times C \simeq J^2(V_{14}) \times B$ for some elliptic curves C, B . According to Clemens–Griffiths, $J^2(V_3)$ is irreducible for every nonsingular V_3 , so we can simplify the above isomorphism¹ to obtain $J^2(V_3) \simeq J^2(V_{14})$; we also obtain, as a by-product, the isomorphism $C \simeq B$.

PROPOSITION 1.7. *Let $V = V_{14}$, $X = V_3$ be a pair of smooth Fano varieties related by either of the two birational isomorphisms of Fano–Iskovskikh or of Tregub–Takeuchi. Then $J^2(X) \simeq J^2(V)$, V, X are associated to each other and related by a birational isomorphism of the other type as well.*

Proof. The isomorphism of the intermediate Jacobians was proved in the previous paragraph. Let $J^2(V') = J^2(V'') = J$. By Clemens–Griffiths [CG] or Tyurin [Tyu], the global Torelli Theorem holds for smooth 3-dimensional cubics, so there exists the unique cubic threefold X such that $J^2(X) = J$ as p.p.a.v. Let X' and X'' be the unique cubics associated to V' and V'' . Since $J^2(X') = J^2(V') = J = J^2(V'') = J^2(X'')$, then $X' \simeq X \simeq X''$.

Let now V' and V'' be associated to the same cubic threefold X , and let $J^2(X) = J$. Then by the above $J^2(V') = J^2(X) = J^2(V'')$.

Let X, V be related by, say, a Tregub–Takeuchi birational isomorphism. By Proposition 1.4, V contains a smooth elliptic quintic curve and admits a birational isomorphism of Fano–Iskovskikh type with some cubic X' . Then, as above, $X \simeq X'$ by Global Torelli, and X, V are associated to each other by the definition of the Fano–Iskovskikh birational isomorphism. Conversely, if we start from the hypothesis that X, V are related by a Fano–Iskovskikh birational isomorphism, then the existence of a Tregub–Takeuchi one from V to some cubic X' is affirmed by Theorem 1.2, (iii). Hence, again by Global Torelli, $X \simeq X'$ and we are done. □

¹It is an easy exercise to see that if an abelian variety decomposes into the direct product of two irreducible abelian varieties of different dimensions, then such a decomposition is unique up to isomorphism. The referee pointed out to us the reference to Shioda’s counterexample [Fac. Sc. Univ. Tokio 24, 11-21(1977)] of three nonisomorphic elliptic curves C_1, C_2, C_3 such that $C_1 \times C_2 \simeq C_1 \times C_3$, which shows that the assumption of different dimensions is essential.

2. ABEL–JACOBI MAP AND VECTOR BUNDLES ON A CUBIC THREEFOLD

Let X be a smooth cubic threefold. The authors of [MT] have associated to every normal elliptic quintic curve $C \subset X$ a stable rank 2 vector bundle $\mathcal{E} = \mathcal{E}_C$, unique up to isomorphism. It is defined by Serre's construction:

$$(3) \quad 0 \longrightarrow \mathcal{O}_X \longrightarrow \mathcal{E}(1) \longrightarrow \mathcal{I}_C(2) \longrightarrow 0,$$

where $\mathcal{I}_C = \mathcal{I}_{C,X}$ is the ideal sheaf of C in X . Since the class of C modulo algebraic equivalence is $5l$, where l is the class of a line, the sequence (3) implies that $c_1(\mathcal{E}) = 0$, $c_2(\mathcal{E}) = 2l$. One sees immediately from (3) that $\det \mathcal{E}$ is trivial, and hence \mathcal{E} is self-dual as soon as it is a vector bundle (that is, $\mathcal{E}^\vee \simeq \mathcal{E}$). See [MT, Sect. 2] for further details on this construction.

Let $\mathcal{H}^* \subset \text{Hilb}_X^{5n}$ be the open set of the Hilbert scheme parametrizing normal elliptic quintic curves in X , and $M \subset M_X(2; 0, 2)$ the open subset in the moduli space of vector bundles on X parametrizing those stable rank 2 vector bundles which arise via Serre's construction from normal elliptic quintic curves. Let $\phi^* : \mathcal{H}^* \rightarrow M$ be the natural map. For any reference curve C_0 of degree 5 in X , let $\Phi^* : \mathcal{H}^* \rightarrow J^2(X)$, $[C] \mapsto [C - C_0]$, be the Abel–Jacobi map. The following result is proved in [MT].

THEOREM 2.1. *\mathcal{H}^* and M are smooth of dimensions 10 and 5 respectively. They are also irreducible for generic X . There exist a bigger open subset $\mathcal{H} \subset \text{Hilb}_X^{5n}$ in the nonsingular locus of Hilb_X^{5n} containing \mathcal{H}^* as a dense subset and extensions of ϕ^*, Φ^* to morphisms ϕ, Φ respectively, defined on the whole of \mathcal{H} , such that the following properties are verified:*

(i) *ϕ is a locally trivial fiber bundle in the étale topology with fiber \mathbb{P}^5 . For every $[\mathcal{E}] \in M$, we have $h^0(\mathcal{E}(1)) = 6$, and $\phi^{-1}([\mathcal{E}]) \subset \mathcal{H}$ is nothing but the \mathbb{P}^5 of zero loci of all the sections of $\mathcal{E}(1)$.*

(ii) *The fibers of Φ are finite unions of those of ϕ , and the map $\Psi : M \rightarrow J^2(X)$ in the natural factorization $\Phi = \Psi \circ \phi$ is a quasi-finite étale morphism.*

Now, we will give another interpretation of the vector bundles \mathcal{E}_C . Let us represent the cubic $X = V_3$ as a section of the Pfaffian cubic $\Xi' \subset \mathbb{P}^{14\vee}$ and keep the notation of 1.3. Let \mathcal{K} be the kernel bundle on X whose fiber at $M \in X$ is $\ker H$. Thus \mathcal{K} is a rank 2 vector subbundle of the trivial rank 6 vector bundle $E_X = E \otimes_{\mathbb{C}} \mathcal{O}_X$. Let $i : X \rightarrow \mathbb{P}^{14}$ be the composition $\text{Pl} \circ \text{Cl}$, where $\text{Cl} : X \rightarrow G(2, E)$ is the classifying map of $\mathcal{K} \subset E_X$, and $\text{Pl} : G(2, E) \hookrightarrow \mathbb{P}(\wedge^2 E) = \mathbb{P}^{14}$ the Plücker embedding.

THEOREM 2.2. *For any vector bundle \mathcal{E} obtained by Serre's construction starting from a normal elliptic quintic $C \subset X$, there exists a representation of X as a linear section of Ξ' such that $\mathcal{E}(1) \simeq \mathcal{K}^\vee$ and all the global sections of $\mathcal{E}(1)$ are the images of the constant sections of E_X^\vee via the natural map $E_X^\vee \rightarrow \mathcal{K}^\vee$. For generic X, \mathcal{E} , such a representation is unique modulo the action of $\text{PGL}(6)$ and the map i can be identified with the restriction $v_2|_X$ of the Veronese embedding $v_2 : \mathbb{P}^4 \rightarrow \mathbb{P}^{14}$ of degree 2.*

Proof. Let $C \subset X$ be a normal elliptic quintic. By Theorem 1.1, there exists a $V_{14} = G \cap \Lambda$ together with a birational isomorphism $X \dashrightarrow V_{14}$. Proposition 1.7 implies that X and V_{14} are associated to each other. By Proposition 1.4, we have $C = \{H^\vee \in X \mid c_H \subset L\} = \text{Cl}^{-1}(\sigma_{11}(L))$, where $\sigma_{11}(L)$ denotes the Schubert variety in G parametrizing the lines $c \subset \mathbb{P}(E)$ contained in L . It is standard that $\sigma_{11}(L)$ is the scheme of zeros of a section of the dualized universal rank 2 vector bundle \mathcal{S}^\vee on G . Hence C is the scheme of zeros of a section of $\mathcal{K}^\vee = \text{Cl}^*(\mathcal{S}^\vee)$. Hence \mathcal{K}^\vee can be obtained by Serre's construction from C , and by uniqueness, $\mathcal{K}^\vee \simeq \mathcal{E}_C(1)$.

By Lemma 2.1, c) of [MT], $h^0(\mathcal{E}_C(1)) = 6$, so, to prove the assertion about global sections, it is enough to show the injectivity of the natural map $E^\vee = H^0(E_X^\vee) \rightarrow H^0(\mathcal{K}^\vee)$. The latter is obvious, because the quartic da Palatini is not contained in a hyperplane. Thus we have $E^\vee = H^0(\mathcal{K}^\vee)$.

For the identification of i with $v_2|_X$, it is sufficient to show that i is defined by the sections of $\mathcal{O}(2)$ in the image of the map $\text{ev} : \Lambda^2 H^0(\mathcal{E}(1)) \rightarrow H^0(\det(\mathcal{E}(1))) = H^0(\mathcal{O}(2))$ and that ev is an isomorphism. This is proved in the next lemmas. The uniqueness modulo $PGL(6)$ is proved in Lemma 2.7. □

LEMMA 2.3. *Let $\text{Pf}_2 : \mathbb{P}^{14} \dashrightarrow \mathbb{P}^{14}$ be the Pfaffian map, sending a skew-symmetric 6×6 matrix M to the collection of its 15 quadratic Pfaffians. Then $\text{Pf}_2^2 = \text{id}_{\mathbb{P}^{14}}$, the restriction of Pf_2 to $\mathbb{P}^{14} \setminus \Xi$ is an isomorphism onto $\mathbb{P}^{14} \setminus G$, and $i = \text{Pf}_2|_X$.*

Thus Pf_2 is an example of a Cremona quadratic transformation. Such transformations were studied in [E-SB].

Proof. Let $(e_i), (\epsilon_i)$ be dual bases of E, E^\vee respectively, and $(e_{ij} = e_i \wedge e_j), (\epsilon_{ij})$ the corresponding bases of $\Lambda^2 E, \Lambda^2 E^\vee$. Identify M in the source of Pf_2 with a 2-form $M = \sum a_{ij} \epsilon_{ij}$. Then Pf_2 can be given by the formula $\text{Pf}_2(M) = \frac{1}{2^{14} 1!} M \wedge M \lrcorner e_{123456}$, where $e_{123456} = e_1 \wedge \dots \wedge e_6$, and \lrcorner stands for the contraction of tensors. Notice that Pf_2 sends 2-forms of rank 6, 4, resp. 2 to bivectors of rank 6, 2, resp. 0. Hence Pf_2 is not defined on G' and contracts $\Xi' \setminus G'$ into G . In fact, the Pfaffians of a 2-form M of rank 4 are exactly the Plücker coordinates of $\ker M$, which implies $i = \text{Pf}_2|_X$.

In order to iterate Pf_2 , we have to identify its source $\mathbb{P}(\Lambda^2 E^\vee)$ with its target $\mathbb{P}(\Lambda^2 E)$. We do it in using the above bases: $\epsilon_{ij} \mapsto e_{ij}$. Let $N = \text{Pf}_2^2(M) = \sum b_{ij} \epsilon_{ij}$. Then each matrix element $b_{ij} = b_{ij}(M)$ is a polynomial of degree 4 in (a_{kl}) , vanishing on Ξ' . Hence it is divisible by the equation of Ξ' , which is the cubic Pfaffian $\text{Pf}(M)$. We can write $b_{ij} = \tilde{b}_{ij} \text{Pf}(M)$, where \tilde{b}_{ij} are some linear forms in (a_{kl}) . Testing them on a collection of simple matrices with only one variable matrix element, we find the answer: $\text{Pf}_2(M) = \text{Pf}(M)M$. Hence Pf_2 is a birational involution. □

LEMMA 2.4. *Let $l \subset V_3$ be a line. Then $i(l)$ is a conic in \mathbb{P}^{14} , and the lines of \mathbb{P}^5 parametrized by the points of $i(l)$ sweep out a quadric surface of rank 3 or 4.*

Proof. The restriction of Cl to the lines in V_3 is written out in [AR] on pages 170 (for a non-jumping line of \mathcal{K} , formula (49.5)) and 171 (for a jumping line). These formulas imply the assertion; in fact, the quadric surface has rank 4 for a non-jumping line, and rank 3 for a jumping one. \square

LEMMA 2.5. *The map i is injective.*

Proof. Let $\tilde{\Xi}$ be the natural desingularization of Ξ' parametrizing pairs (M, l) , where M is a skew-symmetric 6×6 matrix and l is a line in the projectivized kernel of M . We have $\tilde{\Xi} = \mathbb{P}(\wedge^2(E_X/\mathcal{S}))$, where \mathcal{S} is the tautological rank 2 vector bundle on $G = G(2, 6)$. $\tilde{\Xi}$ has two natural projections $p : \tilde{\Xi} \rightarrow G \subset \mathbb{P}^{14}$ and $q : \tilde{\Xi} \rightarrow \Xi' \subset \mathbb{P}^{14\vee}$. The classifying map of \mathcal{K} is just $\text{Cl} = pq^{-1}$. q is isomorphic over the alternating forms of rank 4, so $q^{-1}(V_3) \simeq V_3$. p is at least bijective on $q^{-1}(V_3)$. In fact, it is easy to see that the fibers of p can only be linear subspaces of \mathbb{P}^{14} . Indeed, the fiber of p is nothing but the family of matrices M whose kernel contains a fixed plane, hence it is a linear subspace \mathbb{P}^5 of $\mathbb{P}^{14\vee}$, and the fibers of $p|_{q^{-1}(V_3)}$ are $\mathbb{P}^5 \cap V_3$. As V_3 does not contain planes, the only possible fibers are points or lines. By the previous lemma, they can be only points, so i is injective. \square

LEMMA 2.6. *i is defined by the image of the map $\text{ev} : \Lambda^2 H^0(\mathcal{E}(1)) \rightarrow H^0(\det(\mathcal{E}(1))) = H^0(\mathcal{O}(2))$ considered as a linear subsystem of $|\mathcal{O}(2)|$.*

Proof. Let $(x_i = \epsilon_i)$ be the coordinate functions on E , dual to the basis (e_i) . The x_i can be considered as sections of \mathcal{K}^\vee . Then $x_i \wedge x_j$ can be considered either as an element x_{ij} of $\Lambda^2 E^\vee = \Lambda^2 H^0(\mathcal{K}^\vee)$, or as a section s_{ij} of $\Lambda^2 \mathcal{K}^\vee$. For a point $x \in V_3$, the Plücker coordinates of the corresponding plane $K_x \subset E$ are $x_{ij}(\nu)$ for a non zero bivector $\nu \in \Lambda^2 K_x$. By construction, this is the same as $s_{ij}(x)(\nu)$. This proves the assertion. \square

LEMMA 2.7. *Let $X \xrightarrow{\sim} \Xi' \cap \Lambda_1$, $X \xrightarrow{\sim} \Xi' \cap \Lambda_2$ be two representations of X as linear sections of Ξ' , $\mathcal{K}_1, \mathcal{K}_2$ the corresponding kernel bundles on X . Assume that $\mathcal{K}_1 \simeq \mathcal{K}_2$. Then there exists a linear transformation $A \in GL(E^\vee) = GL_6$ such that $\Xi' \cap \wedge^2 A(\Lambda_1)$ and $\Xi' \cap \Lambda_2$ have the same image under the classifying maps into G . The family of linear sections $\Xi' \cap \Lambda$ of the Pfaffian cubic with the same image in G is a rationally 1-connected subvariety of $G(5, 15)$, generically of dimension 0.*

Proof. The representations $X \xrightarrow{\sim} \Xi' \cap \Lambda_1$, $X \xrightarrow{\sim} \Xi' \cap \Lambda_2$ define two isomorphisms $f_1 : E^\vee \rightarrow H^0(\mathcal{K}_1)$, $f_2 : E^\vee \rightarrow H^0(\mathcal{K}_2)$. Identifying $\mathcal{K}_1, \mathcal{K}_2$, define $A = f_2^{-1} \circ f_1$. Assume that $\Lambda = \wedge^2 A(\Lambda_1) \neq \Lambda_2$. Then the two 3-dimensional cubics $\Xi' \cap \Lambda$ and $\Xi' \cap \Lambda_2$ are isomorphic by virtue of the map $f = f_2 \circ f_1^{-1} \circ (\wedge^2 A)^{-1}$. By construction, we have $\ker M = \ker f(M)$ for any $M \in \Xi' \cap \Lambda$. Hence $\Xi' \cap \Lambda$ and

$\Xi' \cap \Lambda_2$ represent two cross-sections of the map pq^{-1} defined in the proof of Lemma 2.5 over their common image $Y = pq^{-1}(\Xi' \cap \Lambda) = pq^{-1}(\Xi' \cap \Lambda_2)$, and f is a morphism over Y . These cross-sections do not meet the indeterminacy locus $G' \subset \Xi'$ of pq^{-1} , because it is at the same time the singular locus of Ξ' and both 3-dimensional cubics are nonsingular. The fibers of pq^{-1} being linear subspaces of $\mathbb{P}^{14\vee}$, the generic element of a linear pencil $X_{\lambda:\mu} = \Xi' \cap (\lambda\Lambda + \mu\Lambda_2)$ represents also a cross-section of pq^{-1} that does not meet G' . So there is a one-dimensional family of representations of X as a linear section of the Pfaffian cubic which are not equivalent under the action of $PGL(6)$ but induce the same vector bundle \mathcal{K} . This family joins $\Xi' \cap \Lambda$ and $\Xi' \cap \Lambda_2$ and its base is an open subset of \mathbb{P}^1 . This cannot happen for generic X, \mathcal{E} , because both the family of vector bundles \mathcal{E} and that of representations of X as a linear section of Ξ' are 5 dimensional for generic X (Theorem 2.1 and Proposition 1.4). □

LEMMA 2.8. *For a generic 3-dimensional linear section V_3 of Ξ' , the 15 quadratic Pfaffians of $M \in V_3$ are linearly independent in $|\mathcal{O}_{V_3}(2)|$.*

The authors of [IR] solve a similar problem: they describe the structure of the restriction of Pf_2 to a 4-dimensional linear section of the Pfaffian cubic.

Proof. It is sufficient to verify this property for a special V_3 . Take Klein’s cubic

$$v^2w + w^2x + x^2y + y^2z + z^2v = 0.$$

Adler ([AR], Lemma (47.2)) gives the representation of this cubic as the Pfaffian of the following matrix:

$$M = \begin{bmatrix} 0 & v & w & x & y & z \\ -v & 0 & 0 & z & -x & 0 \\ -w & 0 & 0 & 0 & v & -y \\ -x & -z & 0 & 0 & 0 & w \\ -y & x & -v & 0 & 0 & 0 \\ -z & 0 & y & -w & 0 & 0 \end{bmatrix}.$$

Its quadratic Pfaffians are given by

$$c_{ij} = (-1)^{i+j+1}(a_{pq}a_{rs} - a_{pr}a_{qs} + a_{ps}a_{qr}),$$

where $p < q < r < s$, $(pqrsij)$ is a permutation of (123456) , and $(-1)^{i+j+1}$ is nothing but its sign. A direct computation shows that the 15 quadratic Pfaffians are linearly independent. □

This ends the proof of Theorem 2.2.

3. MINIMAL SECTIONS OF 2-DIMENSIONAL CONIC BUNDLE

Let X be a generic cubic threefold. To prove the irreducibility of the fibers of the Abel-Jacobi map Φ of Theorem 2.1, we will use other Abel–Jacobi maps. Let us fix a line l_0 in X , and denote by $\Phi_{d,g}$ the Abel–Jacobi map of the family $H_{d,g}$ of curves of degree d and of arithmetic genus g in X having dl_0 as reference curve. The precise domain of definition of $\Phi_{d,g}$ will be specified in the context

in each particular case. So, $\Phi_{5,1}$ will be exactly the above map Φ defined on \mathcal{H} .

We will provide a description of $\Phi_{4,0}$, obtained by an application of the techniques of [I]. This map is defined on the family of normal rational quartics in X . For completeness, we will mention a similar description of $\Phi_{3,0}$, the Abel–Jacobi map of twisted rational cubics in X . As was proved in [MT], these families of curves are irreducible for a generic X .

Let $L_0 \subset X$ be a generic line, $p : \tilde{X} \rightarrow \mathbb{P}^2$ the projection from L_0 , giving to $\tilde{X} = \text{Blowup}_{L_0}(X)$ a structure of a conic bundle. Let $C \subset \mathbb{P}^2$ be a generic conic, then $Y = p^{-1}(C)$ is a 2-dimensional conic bundle, and $p_Y = p|_Y : Y \rightarrow C$ is the conic bundle structure map. It is well known (see [B]), that the discriminant curve $\Delta \subset \mathbb{P}^2$ of p is a smooth quintic, and the components of the reducible conics $\mathbb{P}^1 \vee \mathbb{P}^1$ over points of Δ are parametrized by a non-ramified two-sheeted covering $\pi : \tilde{\Delta} \rightarrow \Delta$. As C is generic, there are 10 distinct points in $\Delta \cap C$, giving us 10 pairs of lines $\{l_1 \cup l'_1 \cup \dots \cup l_{10} \cup l'_{10}\} = p^{-1}(\Delta \cap C)$. We will identify the components l of reducible fibers of p with points of $\tilde{\Delta}$, so that $\{l_1, l'_1, \dots, l_{10}, l'_{10}\} = \pi^{-1}(\Delta \cap C) \subset \tilde{\Delta}$. Let $p_\alpha : Y_\alpha \rightarrow C$ be any of the 2^{10} ruled surfaces obtained by contracting the l'_i with $i \in \alpha$ and the l_j with $j \notin \alpha$, where α runs over the subsets of $\{1, 2, \dots, 10\}$. Then the Y_α are divided into two classes: even and odd surfaces, according to the parity of the integer $n \geq 0$ such that $Y_\alpha \simeq \mathbb{F}_n = \mathbb{P}(\mathcal{O}_{\mathbb{P}^1} \oplus \mathcal{O}_{\mathbb{P}^1}(-n))$. Remark, that the surfaces Y_α are in a natural one-to-one correspondence with effective divisors D of degree 10 on $\tilde{\Delta}$ such that $\pi_* D = \Delta \cap C$. The 10 points of such a divisor correspond to lines (l_i or l'_i) which are not contracted by the map $Y \rightarrow Y_\alpha$. For a surface Y_α , associated to an effective divisor D of degree 10, we will use the alternative notation Y_D .

The next theorem is a particular case of the result of [I].

THEOREM 3.1. *Let X be a generic cubic threefold, $C \subset \mathbb{P}^2$ a generic conic. Then, in the above notation, the following assertions hold:*

- (i) *There are only two isomorphism classes of surfaces among the $Y_\alpha : Y_{\text{odd}} \simeq \mathbb{F}_1$ and $Y_{\text{even}} \simeq \mathbb{F}_0 \simeq \mathbb{P}^1 \times \mathbb{P}^1$.*
- (ii) *The family \mathcal{C}_- of the proper transforms in X of (-1) -curves in each one of the odd surfaces $Y_\alpha \simeq \mathbb{F}_1$ over all sufficiently generic conics $C \subset \mathbb{P}^2$ is identified with a dense open subset in the family of twisted rational cubic curves $C^3 \subset X$ meeting L_0 at one point.*
- (iii) *Let $\Phi_{3,0}$ be the Abel–Jacobi map of the family of rational twisted cubics. Let $\Phi_- = \Phi_{3,0}|_{\mathcal{C}_-}$ be its restriction. Then Φ_- is onto an open subset of the theta divisor of $J^2(X)$. For generic $C^3 \in \mathcal{C}_-$, which is a proper transform of the (-1) -curve in the ruled surface Y_α associated to an effective divisor D_α of degree 10 on $\tilde{\Delta}$, the fiber $\Phi_-^{-1}\Phi_-(C^3)$ can be identified with an open subset of $\mathbb{P}^1 = |D_\alpha|$ by the following rule:*

$$D \in |D_\alpha| \mapsto \begin{cases} \text{the proper transform in } X \text{ of the } (-1)\text{-curve in } Y_D \text{ if} \\ Y_D \simeq \mathbb{F}_1 \end{cases}$$

(iv) Let \mathcal{C}_+ be the family of the proper transforms in X of the curves in the second ruling on any one of the even surfaces $Y_\alpha \simeq \mathbb{P}^1 \times \mathbb{P}^1$ for all sufficiently generic conics C ; the second ruling means the one which is different from that consisting of fibers of π_α . Then \mathcal{C}_+ is identified with a dense open subset in the family of normal rational quartic curves $C^4 \subset X$ meeting L_0 at two points.

(v) Let $\Phi_{4,0}$ be the Abel–Jacobi map of the family of rational normal quartics. Let $\Phi_+ = \Phi_{4,0}|_{\mathcal{C}_+}$ be its restriction. Then Φ_+ is onto an open subset of $J^2(X)$. For generic $C^4 \in \mathcal{C}_+$ which is the proper transform of a curve on the ruled surface Y_α associated to an effective divisor D_α of degree 10 on $\tilde{\Delta}$, we have $\dim |D_\alpha| = 0$ and the fiber $\Phi_+^{-1}\Phi_+(C^4) \simeq \mathbb{P}^1$ consists of the proper transforms of all the curves of the second ruling on Y_α .

The irreducibility of $\Phi_+^{-1}\Phi_+(C^4)$ in the above statement is an essential ingredient of the proof of the following theorem, which is the main result of the paper.

THEOREM 3.2. *Let X be a nonsingular cubic threefold. Then the degree of the étale map Ψ from Theorem 2.1 is 1. Equivalently, all the fibers of the Abel–Jacobi map Φ are isomorphic to \mathbb{P}^5 .*

This obviously implies:

COROLLARY 3.3. *The open set $M \subset M_X(2; 0, 2)$ in the moduli space of vector bundles on X parametrizing those stable rank 2 vector bundles which arise via Serre’s construction from normal elliptic quintics is isomorphic to an open subset in the intermediate Jacobian of X .*

We will start by the following lemma.

LEMMA 3.4. *Let X be a generic cubic threefold. Let $z \in J^2(X)$ be a generic point, $\mathcal{H}_i(z) \simeq \mathbf{P}^5$ any component of $\Phi^{-1}(z)$. Then, for any line $l \subset X_3$, the family*

$\mathcal{H}_{i,i}(z) := \{C \in \mathcal{H}_i(z) : C = l + C', \text{ where } C' \text{ is a curve of degree 4}\}$
is isomorphic to \mathbf{P}^1 .

Proof. By Theorem 2.1, the curve C represented by the generic point of $\mathcal{H}_i(z)$ is a (smooth) normal elliptic quintic. Let $\mathcal{E} = \mathcal{E}_C$ be the associated vector bundle, represented by the point $\phi([C]) \in M$. Choose any representation of X as a linear section of the Pfaffian cubic Ξ' as in Theorem 2.2, so that $\mathcal{E}(1) \simeq \mathcal{K}^\vee$. The projective space $\mathcal{H}_i(z)$ is naturally identified with $\mathbb{P}^{5^\vee} = \mathbb{P}(E^\vee)$. This follows from the proof of Theorem 2.2. Indeed, the curves C represented by points of $\mathcal{H}_i(z)$ are exactly the zero loci of the sections of $\mathcal{E}(1)$, and the latter are induced by linear forms on E via the natural surjection $E_X \rightarrow \mathcal{K}^\vee$. The zero loci of these sections are of the form $\text{Cl}^{-1}(\sigma_{11}(L))$, where $L \in \mathbb{P}^{5^\vee}$ runs over all the hyperplanes in \mathbb{P}^5 .

Let l be a line in X . By Lemma 2.4, the quadratic pencil of lines with base $\text{Cl}(l)$ sweeps out a quadric surface $Q(l)$ of rank 3 or 4. Let $\langle Q(l) \rangle \simeq \mathbb{P}^3$ be the linear span of $Q(l)$ in \mathbb{P}^5 . Then l is a component of $\text{Cl}^{-1}(\sigma_{11}(L))$ if and only if $\langle Q(l) \rangle \supset L$. Such hyperplanes L form the pencil $\langle Q(l) \rangle^\vee \simeq \mathbb{P}^1$ in

$\mathbb{P}^{5\nu}$. Obviously, the pencil $\{\text{Cl}^{-1}(\sigma_{11}(L)) \mid L \in \langle Q(l) \rangle^\vee\}$ contains exactly all the curves, represented by points of $\mathcal{H}_i(z)$ and having l as an irreducible component. \square

Now our aim is to show that the generic member of $\mathcal{H}_{i,i}(z)$ is a rational normal quartic having l as one of its chords. Then we will be able to apply the description of such curves given by Theorem 3.1, (iv), (v).

4. SMOOTHING $C' + l$

Let X be a nonsingular cubic threefold, $C = C' + l \subset X$ a rational normal quartic plus one of its chords. Then one can apply Serre's construction (3) to C to obtain a self-dual rank 2 vector bundle $\mathcal{E} = \mathcal{E}_C$ in $M_X(2; 0, 2)$ like it was done in [MT] for a nonsingular C . One proves directly that \mathcal{E} possesses all the essential properties of the vector bundles constructed from normal elliptic quintics. First of all, our C is a locally complete intersection in X with trivial canonical sheaf ω_C , and this implies (see the proofs of Lemma 2.1 and Corollary 2.2 in loc. cit.) that $\text{Ext}^1(\mathcal{I}_C(2), \mathcal{O}_X) \simeq H^0(C, \omega_C) \simeq \mathbb{C}$ and that $\mathcal{E}xt_{\mathcal{O}_X}^1(\mathcal{I}_C(2), \mathcal{O}_X) = \mathcal{E}xt_{\mathcal{O}_X}^2(\mathcal{O}_C, \omega_X) = \omega_C$, so that \mathcal{E} is uniquely determined up to isomorphism and is locally free. One can also easily show that $h^0(\mathcal{I}_C(1)) = h^1(\mathcal{I}_C(1)) = h^2(\mathcal{I}_C(1)) = 0$, and this implies (see the proofs of Corollary 2.4, Proposition 2.6 and Lemma 2.8 in loc. cit.) the stability of \mathcal{E} and the fact that the zero loci of nonproportional sections of $\mathcal{E}(1)$ are distinct complete intersection linearly normal quintic curves. Further, remark that $h^0(\mathcal{I}_C(2)) = 5$ (the basis of $H^0(\mathcal{I}_C(2))$ is given in appropriate coordinates in (10) below); the restriction exact sequence

$$(4) \quad 0 \longrightarrow \mathcal{I}_C(k) \longrightarrow \mathcal{O}_X(k) \longrightarrow \mathcal{O}_C(k) \longrightarrow 0$$

with $k = 2$ implies also $h^i(\mathcal{I}_C(2)) = 0$ for $i > 0$. One deduces from here $h^0(\mathcal{E}(1)) = 6, h^i(\mathcal{E}(1)) = 0$ for $i > 0$. Hence the sections of $\mathcal{E}(1)$ define a \mathbb{P}^5 in Hilb_X^{5n} .

We are going to show that this \mathbb{P}^5 is of the form $\mathcal{H}_i(z)$, that is $\mathcal{E}(1)$ has a section whose zero locus is a (smooth) normal elliptic quintic.

LEMMA 4.1. $\mathcal{E}(1)$ is globally generated.

Proof. The vanishing

$$(5) \quad h^1(\mathcal{I}_C(2)) = h^2(\mathcal{I}_C(1)) = h^3(\mathcal{I}_C) = 0,$$

implies the Castelnuovo–Mumford regularity condition for $F = \mathcal{E}(1)$:

$$H^i(X, F(-i)) = 0, \quad i = 1, 2, \dots, \dim X.$$

By 2.4 of [AC], the Castelnuovo–Mumford regularity implies that F is generated by global sections. \square

COROLLARY 4.2. *The zero locus of a generic section of $\mathcal{E}(1)$ is a normal elliptic quintic curve.*

Proof. The Bertini–Sard Theorem yields the smoothness of the zero locus C_s of a generic section s . Moreover, C_s spans \mathbb{P}^4 , because C does, and by flatness, it is an elliptic quintic. \square

Next, we will show that the locus of the curves of type ‘normal rational quartic plus its chord’ inside the $\mathbb{P}^5 = \mathbb{P}(H^0(X, \mathcal{E}(1)))$ has at least one 3-dimensional component. By a standard dimension count, this will imply that all the components of this locus are 3-dimensional for generic (X, \mathcal{E}) , and that $\mathcal{H}_i(z)$ contains, for generic z , a purely 3-dimensional locus of curves of type ‘normal rational quartic plus its chord’.

LEMMA 4.3. *Let X be a nonsingular cubic threefold, $C = C' + l \subset X$ a rational normal quartic plus one of its chords. Then $h^0(\mathcal{N}_{C/X}) = 10$, $h^1(\mathcal{N}_{C/X}) = 0$, hence Hilb_X^{5n} is smooth of dimension 10 at $[C]$.*

Assume now that X, C are generic. Then the deformation $\mathfrak{C} \rightarrow U$ of C over a sufficiently small open subset $U \subset \text{Hilb}_X^{5n}$ parametrizes curves of only the following three types: (a) for u in a dense open subset of U , C_u is a normal elliptic quintic; (b) over an open subset of a divisor $\Delta_1 \subset U$, C_u is a linearly normal rational curve with only one node as singularity; (c) over a closed subvariety of pure codimension 2 $\Delta_2 \subset U$, C_u is of the same type as C , that is a normal rational quartic plus one of its chords.

Proof. As concerns the numerical values for the h^i , the proof goes exactly as that of Lemma 2.7 in [MT] with only one modification: the authors used there the property of a normal elliptic quintic $h^0(\mathcal{N}_{C/\mathbb{P}^4}(-2)) = 0$, proved in Proposition V.2.1 of [Hu]. Here we should verify directly this property for our curve $C = C' + l$. This is an easy exercise using the techniques, developed in [HH] for the study of deformations of nodal curves². One can use the identifications of the normal bundles of C', l

$$(6) \quad \mathcal{N}_{C'/\mathbb{P}^4} \simeq 3\mathcal{O}_{\mathbb{P}^1}(6), \quad \mathcal{N}_{l/\mathbb{P}^4} \simeq 3\mathcal{O}_{\mathbb{P}^1}(1)$$

and the three natural exact sequences

$$(7) \quad 0 \rightarrow \mathcal{N}_{C/W} \rightarrow \mathcal{N}_{C/W}|_{C'} \oplus \mathcal{N}_{C/W}|_l \rightarrow \mathcal{N}_{C/W} \otimes \mathbb{C}_S \rightarrow 0,$$

$$(8) \quad 0 \rightarrow \mathcal{N}_{C'/W} \rightarrow \mathcal{N}_{C/W}|_{C'} \rightarrow T_S^1 \rightarrow 0,$$

$$(9) \quad 0 \rightarrow \mathcal{N}_{l/W} \rightarrow \mathcal{N}_{C/W}|_l \rightarrow T_S^1 \rightarrow 0,$$

where $S = \{P_1, P_2\} = C' \cap l$, $\mathbb{C}_S = \mathbb{C}_{P_1} \oplus \mathbb{C}_{P_2}$ is the sky-scraper sheaf with the only nonzero stalks at P_1, P_2 equal to \mathbb{C} , $W = \mathbb{P}^4$, and T_S^1 denotes Schlesinger’s T^1 of a singularity; we have $T_S^1 \simeq \mathbb{C}_S$ for nodal curves.

For the last assertion of the lemma, we need the surjectivity of the Schlesinger map $\delta : T_{[C]} \text{Hilb}_X^{5n} = H^0(\mathcal{N}_{C/X}) \rightarrow T_S^1$. Then the natural maps $\delta_i : H^0(\mathcal{N}_{C/X}) \rightarrow T_{P_i}^1 C = \mathbb{C}_{P_i}$ are surjective. Hence the discriminant divisor

²Hartshorne–Hirschowitz formulated all the results for nodal curves in \mathbb{P}^3 , but the techniques of the paper remain valid if one replaces \mathbb{P}^3 by any nonsingular projective variety; see Remark 4.1.1 in [HH].

$\Delta_1 \subset U$ has locally analytically two nonsingular branches with tangent spaces $\ker \delta_i \subset H^0(\mathcal{N}_{C/X}) = T_{[C]} \text{Hilb}_X^{5n}$, each unfolding only one of the two singular points of C , and their transversal intersection Δ_2 parametrizes the deformations preserving the two singular points.

The surjectivity of δ for a particular pair (X, C) follows from the next lemma, where even a stronger assertion is proved, hence it holds for a generic pair (X, C) . \square

LEMMA 4.4. *There exists a pair (X, C) , consisting of a nonsingular cubic threefold X and a curve $C = C' + l \subset X$, where C' is a rational normal quartic and l its chord, such that the following property is verified:*

Let \mathcal{E} be the vector bundle on X defined by C and $\mathcal{H}_{\mathcal{E}} \subset \text{Hilb}_X^{5n}$ the \mathbb{P}^5 of zero loci of sections of $\mathcal{E}(1)$. Let $\delta_{\mathcal{E}} : T_{[C]} \mathcal{H}_{\mathcal{E}} \rightarrow T_S^1$ be the restriction of the Schlesinger map δ to the tangent space of $\mathcal{H}_{\mathcal{E}}$ at $[C]$. Then $\delta_{\mathcal{E}}$ is surjective.

Proof. Choose a curve C of type $C' + l$ in \mathbb{P}^4 , then a cubic X passing through C . Take, for example, the closures of the following affine curves:

$$C' = \{x_1 = t, x_2 = t^2, x_3 = t^3, x_4 = t^4\}, \quad l = \{x_1 = x_2 = x_3 = 0\}.$$

The family of quadrics passing through C is 5-dimensional with generators

$$(10) \quad Q_1 = x_2 - x_1^2, \quad Q_2 = x_3 - x_1x_2, \quad Q_3 = x_1x_3 - x_2^2, \\ Q_4 = x_1x_4 - x_2x_3, \quad Q_5 = x_2x_4 - x_3^2.$$

The cubic hypersurface in \mathbb{P}^4 with equation $\sum \alpha_i(x)Q_i$ is nonsingular for generic linear forms $\alpha_i(x)$, so we can choose X to be of this form. We verified, in using the Macaulay program [BS], that the choice $\alpha_1 = 0, \alpha_2 = -1, \alpha_3 = x_2, \alpha_4 = -x_1, \alpha_5 = x_4$ yields a nonsingular $X = \{x_1x_2 - x_2^3 - x_3 + 2x_1x_2x_3 - x_1^2x_4 - x_3^2x_4 + x_2x_4^2 = 0\}$.

Look at the following commutative diagram with exact rows and columns, where the first row is the restriction of (3) to the subsheaf of the sections of $\mathcal{E}(1)$ vanishing along C .

$$\begin{array}{ccccccc}
 & & & 0 & & 0 & \\
 & & & \downarrow & & \downarrow & \\
 0 & \longrightarrow & \mathcal{O}_X & \longrightarrow & \mathcal{E}(1) \otimes \mathcal{I}_C & \longrightarrow & \mathcal{I}_C^2(2) \longrightarrow 0 \\
 & & \parallel & & \downarrow & & \downarrow \\
 (11) \quad 0 & \longrightarrow & \mathcal{O}_X & \longrightarrow & \mathcal{E}(1) & \longrightarrow & \mathcal{I}_C(2) \longrightarrow 0 \\
 & & & & \downarrow & & \downarrow \\
 & & & & \mathcal{N}_{C/X} & \xlongequal{\quad} & \mathcal{N}_{C/X}^\vee(2) \\
 & & & & \downarrow & & \downarrow \\
 & & & & 0 & & 0
 \end{array}$$

It allows to identify the tangent space $T_{[\mathcal{E}]} \mathcal{H}_\mathcal{E} = H^0(\mathcal{E}(1))/H^0(\mathcal{E}(1) \otimes \mathcal{I}_C)$ with the image of $H^0(\mathcal{I}_C(2))$ in $H^0(\mathcal{N}_{C/X}) = H^0(\mathcal{I}_C(2)/\mathcal{I}_C^2(2))$. So, we have to show that the derivative $d : H^0(\mathcal{I}_C(2)) \rightarrow T_S^1 C$ is surjective. Using the basis (10) of $H^0(\mathcal{I}_C(2))$, we easily verify that this is the case (in fact, dQ_1, dQ_2 generate $T_S^1 C$). \square

The following assertion is an obvious consequence of the lemma:

COROLLARY 4.5. *Let X be a generic cubic threefold, $C = C' + l \subset X$ a generic rational normal quartic plus one of its chords, \mathcal{E} the vector bundle defined by C . Let $\mathcal{H}_\mathcal{E} \subset \text{Hilb}_X^{5n}$ be the \mathbb{P}^5 of zero loci of sections of $\mathcal{E}(1)$. Then, with the notations of Lemma 4.3, $\dim \Delta_i \cap \mathcal{H}_\mathcal{E} = 5 - i$ for $i = 1, 2$.*

LEMMA 4.6. *With the hypotheses of Lemma 3.4, the family $\mathcal{C}_i(z)$ of curves of the form $C' + l$ in $\mathcal{H}_i(z)$, where C' is a rational normal quartic and l one of its chords, is non-empty and equidimensional of dimension 3.*

Proof. According to [MT], the family of rational normal quartics in a nonsingular cubic threefold X has dimension 8, and is irreducible for generic X . By Theorem 1.2, each rational normal quartic C' has exactly 16 chords l in X , so the family $\Delta_2 = \Delta_2(X)$ of pairs $C' + l$ is equidimensional of dimension 8. It suffices to verify that one of the components of Δ_2 , say $\Delta_{2,0}$, meets $\mathcal{H}_i(z)$ at some point b with local dimension $\dim_b \Delta_{2,0} \cap \mathcal{H}_i(z) = 3$ for one special cubic threefold X , for one special z and for at least one i . But this is asserted by Corollary 4.5. Indeed, the fact that C can be smoothed inside $\mathcal{H}_\mathcal{E}$ implies that $\mathcal{E} \in \mathcal{H}$, hence $\mathcal{H}_\mathcal{E} = \mathcal{H}_i(z)$ for some i, z . The assertion for general X, z follows by the relativization over the family of cubic threefolds and the standard count of dimensions. \square

COROLLARY 4.7. *With the hypotheses of Lemma 3.4, let l be a generic line in X . Then the generic member of the pencil $\mathcal{H}_{1,i}(z)$ is a rational normal quartic plus one of its chords.*

Proof. We know already that the family $D_i(z)$ of pairs $C' + l \in \mathcal{C}_i(z)$ is 3-dimensional. Now we are to show that the second components l of these pairs move in a dense open subset in the Fano surface $F(X)$ of X . This is obviously true, since, by Lemma 3.4, the dimension of the fibers of the projection $D_i(z) \rightarrow F(X)$ is at most 1. \square

5. FIBERS OF $\Phi_{4,0}$, $\Phi_{5,1}$ AND PERIODS OF VARIETIES V_{14}

Now we are able to prove Theorem 3.2. Let X be a generic cubic threefold. Let $\Phi_{1,0}$, $\Phi_{4,0}$, resp. $\Phi^* = \Phi_{5,1}^*$ be the Abel–Jacobi map of lines, rational normal quartics, resp. elliptic normal quintics. We will use the notation Φ , or $\Phi_{5,1}$ for the extension of Φ^* defined in the statement of Theorem 2.1. By Lemma 4.5, the generic curves of the form $C' + l$, where C' is a rational normal quartic and l one of its chords, are elements of \mathcal{H} , the domain of Φ .

Proof of Theorem 3.2. Let $z \in J^2(X)$ be a generic point, $\mathcal{H}_i(z) \simeq \mathbf{P}^5$ any component of $\Phi^{-1}(z)$. Choose a generic line l on X . In the notations of Lemma 3.4, the number of pencils $\mathcal{H}_{i,i}(z) \simeq \mathbb{P}^1$ with generic member $C'_i + l$, where C'_i is a rational normal quartic meeting l quasi-transversely at 2 points, and mapped to the same point z of the intermediate Jacobian, is equal to the degree d of Ψ . Now look at the images of the curves C'_i arising in these pencils under the Abel–Jacobi map $\Phi_{4,0}$. Denoting AJ the Abel–Jacobi map on the algebraic 1-cycles homologous to 0, we have $AJ((C'_i + l) - (C'_j + l)) = AJ(C'_i - C'_j) = z - z = 0$. Hence $\Phi_{4,0}(C'_i) = \Phi_{4,0}(C'_j)$ is a constant point $z' \in J^2(X)$. According to Theorem 3.1, the family of the normal rational quartics in a generic fiber of $\Phi_{4,0}$ meeting a generic line at two points is irreducible and is parametrized by (an open subset of) a \mathbb{P}^1 . The point z' is a generic one, because $\Phi_{4,0}$ is dominant, and every rational normal quartic has at least one chord. Hence $d = 1$ and we are done. \square

COROLLARY 5.1. *M, \mathcal{H} are irreducible and the degree of Ψ is 1 not only for a generic cubic X , but also for every nonsingular one.*

Proof. One can easily relativize the constructions of $\mathcal{H}, M, \Phi, \phi, \Psi$, etc. over a small analytic (or étale) connected open set U in the parameter space \mathbb{P}^{34} of 3-dimensional cubics, over which all the cubics X_u are nonsingular. We have to restrict ourselves to a “small” open set, because we need a local section of the family $\{\mathcal{H}_u\}$ in order to define the maps Φ, Ψ .

The fibers \mathcal{H}_u, M_u are equidimensional and nonsingular of dimensions 10, 5 respectively. Moreover, it is easy to see that a normal elliptic quintic C_0 in a special fiber X_{u_0} can be deformed to the neighboring fibers X_u . Indeed, one can embed the pencil $\lambda X_{u_0} + \mu X_u$ into the linear system of hyperplane sections of a 4-dimensional cubic Y and show that the local dimension of the Hilbert scheme of Y at $[C_0]$ is 15, which implies that C_0 deforms to all the nearby and hence to all the nonsingular hyperplane sections of Y .

Hence the families $\{\mathcal{H}_u\}, \{M_u\}$ are irreducible, flat of relative dimensions 10, resp. 5 over U , and the degree of Ψ is constant over U . If there is a reducible

fiber M_u , then the degree sums up over its irreducible components, so it has to be strictly greater than 1. But we know, that d is 1 over the generic fiber, hence all the fibers are irreducible and $d = 1$ for all u . \square

We are going to relate the Abel–Jacobi mapping of elliptic normal quintics with that of rational normal quartics. With our convention for the choice of reference curves in the form dl_0 for a line l_0 , fixed once and forever, we have the identity

$$\Phi_{5,1}(C' + l) = \Phi_{4,0}(C') + \Phi_{1,0}(l) .$$

THEOREM 5.2. *Let X be a generic cubic threefold, $z \in J^2(X)$ a generic point. Then the corresponding fiber $\Phi_{4,0}^{-1}(z)$ is an irreducible nonsingular variety of dimension 3, birationally equivalent to X .*

Proof. As we have already mentioned in the proof of Lemma 4.6, the family $H_{4,0}$ of rational normal quartics in X is irreducible of dimension 8. The nonsingularity of $H_{4,0}$ follows from the evaluation of the normal bundle of a rational normal quartic in the proof of Lemma 4.3. We saw also that $\Phi_{4,0} : H_{4,0} \rightarrow J^2(X)$ is dominant, so the generic fiber is equidimensional of dimension 3 and we have to prove its irreducibility.

Let $\pi : \tilde{U} \rightarrow U$ be the quasi-finite covering of $U = \Phi(\mathcal{H})$ parametrizing the irreducible components of the fibers of $\Phi_{4,0}$ over points of U . Let $z \in U$ be generic, and $\mathcal{H}_z \simeq \mathbb{P}^5$ the fiber of Φ . By Corollary 4.7, for a generic line l , we can represent z as $\Phi_{4,0}(C') + \Phi_{1,0}(l)$ for a rational normal quartic C' having l as one of its chords. Let $\kappa : U \dashrightarrow \tilde{U}$ be the rational map sending z to the component of $\Phi_{4,0}^{-1}\Phi_{4,0}(C')$ containing C' . Let $\lambda = \pi \circ \kappa$. Theorem 3.1 implies that λ is dominant. Hence it is generically finite. Then κ is also generically finite, and we have for their degrees $\deg \lambda = (\deg \pi)(\deg \kappa)$.

Let us show that $\deg \lambda = 1$. Let z, z' be two distinct points in a generic fiber of λ . By Theorem 3.1, $\Phi_{4,0}^{-1}\Phi_{4,0}(C')$ contains only one pencil of curves of type $C'' + l$, where l is a fixed chord of C' , and C'' is a rational normal quartic meeting l in 2 points. But Lemma 3.4 and Corollary 4.7 imply that both \mathcal{H}_z and $\mathcal{H}_{z'}$ contain such a pencil. This is a contradiction. Hence $\deg \lambda = \deg \pi = \deg \kappa = 1$.

Now, choose a generic rational normal quartic C' in X . We are going to show that $\Phi_{4,0}^{-1}\Phi_{4,0}(C')$ is birational to some V_{14} , associated to X , and hence birational to X itself. Namely, take the V_{14} obtained by the Tregub–Takeuchi transformation χ from X with center C' . Let $x \in V_{14}$ be the indeterminacy point of χ^{-1} . The pair (x, V_{14}) is determined by (C', X) uniquely up to isomorphism, because V_{14} is the image of X under the map defined by the linear system $|\mathcal{O}_X(8) - 5C'|$ and x is the image of the unique divisor of the linear system $|\mathcal{O}_X(3 - 2C')|$.

By Theorem 1.2, (iii), a generic $\xi \in V_{14}$ defines an inverse map of Tregub–Takeuchi type from V_{14} to the same cubic X . As X is generic, it has no biregular automorphisms, and hence this map defines a rational normal quartic Γ in X . We obtain the rational map $\alpha : V_{14} \dashrightarrow H_{4,0}$, $\xi \mapsto [\Gamma]$, whose image contains

[C']. As $h^{1,0}(V_{14}) = 0$, the whole image $\alpha(V_{14})$ is contracted to a point by the Abel–Jacobi map. Hence, to show that $\Phi_{4,0}^{-1}\Phi_{4,0}(C')$ is birationally equivalent to V_{14} , it suffices to see that α is generically injective. This follows from the following two facts: first, the pair (ξ, V_{14}) is determined by (Γ, X) uniquely up to isomorphism, and second, a generic V_{14} has no biregular automorphisms. If there were two points $\xi, \xi' \in V_{14}$ giving the same Γ , then there would exist an automorphism of V_{14} sending ξ to ξ' , and hence $\xi = \xi'$. Another proof of the generic injectivity of α is given in Proposition 5.6.

We did not find an appropriate reference for the second fact, so we prove it in the next lemma. \square

LEMMA 5.3. *A generic variety V_{14} has no nontrivial biregular automorphisms.*

Proof. As V_{14} is embedded in \mathbb{P}^9 by the anticanonical system, any biregular automorphism g of V_{14} is induced by a linear automorphism of \mathbb{P}^9 . Hence it sends conics to conics, and thus defines an automorphism $F(g) : F(V_{14}) \rightarrow F(V_{14})$ of the Fano surface $F(V_{14})$, parametrizing conics on V_{14} . In [BD], the authors prove that the Hilbert scheme $\text{Hilb}^2(S) = S^{[2]}$ parametrizing pairs of points on the K3 surface S of degree 14 in \mathbb{P}^8 is isomorphic to the Fano 4-fold $F(V_3^4)$ parametrizing lines on V_3^4 , where V_3^4 is the 4-dimensional linear section of the Pfaffian cubic in \mathbb{P}^{14} associated to S . The same argument shows that $F(V_{14}) \simeq F(X)$, where X is the cubic 3-fold associated to V_{14} , and $F(X)$ is the Fano surface parametrizing lines on X .

Hence g induces an automorphism f of $F(X)$. Let f^* be the induced linear automorphism of $\text{Alb}(F(X)) = J^2(X)$, and $T_0 f^*$ its differential at the origin. By [Tyu], the projectivized tangent cone of the theta divisor of $J^2(X)$ at 0 is isomorphic to X , so $T_0 f^*$ induces an automorphism of X . V_{14} being generic, X is also generic, so $\text{Aut}(X) = \{1\}$. Hence $f^* = \text{id}$. By the Tangent Theorem for $F(X)$ [CG], $\Omega_{F(X)}^1$ is identified with the restriction of the universal rank 2 quotient bundle \mathcal{Q} on $G(2, 5)$, and all the global sections of $\Omega_{F(X)}^1$ are induced by linear forms L on \mathbb{P}^4 via the natural map $H^0(\mathbb{P}^4, \mathcal{O}_{\mathbb{P}^4}(1)) \otimes \mathcal{O}_{G(2,5)} \rightarrow \mathcal{Q}$. Hence the fact that f acts trivially on $H^0(\Omega_{F(X)}^1) = T_0^* J^2(X)$ implies that f permutes the lines $l \subset \{L = 0\} \cap X$ lying in one hyperplane section of X . For general L , there are 27 lines l , and in taking two hyperplane sections $\{L_1 = 0\}, \{L_2 = 0\}$ which have only one common line, we conclude that f fixes the generic point of $F(X)$. Hence $F(g)$ is the identity. This implies that every conic on V_{14} is transformed by g into itself.

By Theorem 1.2, we have 16 different conics C_1, \dots, C_{16} passing through the generic point $x \in V_{14}$, which are transforms of the 16 chords of C' in X . Two different conics C_i, C_j cannot meet at a point y , different from x . Indeed, their proper transforms in X^+ (we are using the notations of Theorem 1.2) are the results l_i^+, l_j^+ of the floppings of two distinct chords l_i, l_j of C' . Two distinct chords of C' are disjoint, because otherwise the 4 points $(l_i \cap l_j) \cap C'$ would be coplanar, which would contradict the linear normality of C' . Hence l_i^+, l_j^+ are disjoint. They meet the exceptional divisor M^+ of $X^+ \rightarrow V_{14}$ at one point

each, hence $C_i \cap C_j = \{x\}$. As $g(C_i) = C_i$ and $g(C_j) = C_j$, this implies $g(x) = x$. This ends the proof. \square

5.4. TWO CORRESPONDENCES BETWEEN $H_{4,0}, H_{5,1}$. This subsection contains some complementary information on the relations between the families of rational normal quartics and of elliptic normal quintics on X which can be easily deduced from the above results.

For a generic cubic 3-fold X and any point $c \in J^2(X)$, the Abel–Jacobi maps $\Phi_{4,0}, \Phi_{5,1}$ define a correspondence $Z_1(c)$ between $H_{4,0}, H_{5,1}$ with generic fibers over $H_{5,1}, H_{4,0}$ of dimensions 3, respectively 5:

$$Z_1(c) = \{(\Gamma, C) \in H_{4,0} \times H_{5,1} \mid \Phi_{4,0}(\Gamma) + \Phi_{5,1}(C) = c\}.$$

The structure of the fibers is given by Theorems 3.2 and 5.2: they are, respectively, birational to X and isomorphic to \mathbb{P}^5 .

There is another correspondence, defined in [MT]:

$$Z_2 = \{(\Gamma, C) \in H_{4,0} \times H_{5,1} \mid C + \Gamma = \mathbb{F}_1 \cap X \text{ for a rational normal scroll } \mathbb{F}_1 \subset \mathbb{P}^4\}.$$

It is proved in [MT] that the fiber over a generic $C \in H_{5,1}$ is isomorphic to C , and the one over $\Gamma \in H_{4,0}$ is a rational 3-dimensional variety. In fact, we have the following description for the latter:

LEMMA 5.5. *For any rational normal quartic $\Gamma \subset X$, we have $Z_2(\Gamma) \simeq PGL(2)$.*

Proof. Let $\Gamma \subset \mathbb{P}^4$ be a rational normal quartic. Then there exists a unique $PGL(2)$ -orbit $PGL(2) \cdot g \subset PGL(5)$ transforming Γ to the normal form

$$\{(s^4, s^3t, \dots, t^4)\}_{(s:t) \in \mathbb{P}^1} = \{(x_0, \dots, x_4) \mid \text{rk} \begin{pmatrix} x_0 & x_1 & x_2 & x_3 \\ x_1 & x_2 & x_3 & x_4 \end{pmatrix} \leq 1\}.$$

There is one particularly simple rational normal scroll S containing Γ :

$$S = \{(us^2, ust, ut^2, vs, vt)\} = \{(x_0, \dots, x_4) \mid \text{rk} \begin{pmatrix} x_0 & x_1 & x_3 \\ x_1 & x_2 & x_4 \end{pmatrix} \leq 1\}.$$

Geometrically, S is the union of lines which join the corresponding points of the line $l = \{(0, 0, 0, s, t)\}$ and of the conic $C^2 = \{(s^2, st, t^2, 0, 0)\}$. Conversely, any rational normal scroll can be obtained in this way from a pair (l, C) whose linear span is the whole \mathbb{P}^4 . Remark that $(s : t) \mapsto (s : t)$ is the only correspondence from l to C such that the resulting scroll contains Γ .

Now, it is easy to describe all the scrolls containing Γ : they are obtained from S by the action of $PGL(2)$. Each non-identical transformation from $PGL(2)$ leaves invariant Γ , but moves both l and C , and hence moves S . \square

As the rational normal scrolls in \mathbb{P}^4 are parametrized by a rational variety, the Abel–Jacobi image of $C + \Gamma$ is a constant $c \in J^2(X)$ for all pairs (Γ, C) such that $C \in Z_2(\Gamma)$. Hence we have identically $\Phi_{4,0}(\Gamma) + \Phi_{5,1}(C) = c$ on Z_2 , so that $Z_2(\Gamma) \subset Z_1(c)(\Gamma)$.

We can obtain another birational description of $Z_2(\Gamma)$ for generic Γ in applying to all the $C \in Z_2(\Gamma)$ the Tregub–Takeuchi transformation χ , centered at Γ . Let $\xi \in V_{14}$ be the indeterminacy point of χ^{-1} .

PROPOSITION 5.6. *On a generic V_{14} , the family of elliptic quintic curves is irreducible. It is parametrized by an open subset of a component \mathcal{B} of $\text{Hilb}_{V_{14}}^{5n}$ isomorphic to \mathbb{P}^5 , and all the curves represented by points of \mathcal{B} are l. c. i. of pure dimension 1.*

For any $x \in V_{14}$, the family of curves from $\mathcal{B} = \mathbb{P}^5$ passing through x is a linear 3-dimensional subspace $\mathbb{P}^3 \subset \mathbb{P}^5$. For generic rational normal quartic Γ as above, χ maps $Z_2(\Gamma)$ birationally onto \mathbb{P}^3_ξ .

Proof. Gushel constructs in [G2] for any elliptic quintic curve B on V_{14} a rank two vector bundle \mathcal{G} such that $h^0(\mathcal{G}) = 6$, $\det \mathcal{G} = \mathcal{O}(1)$, $c_2(\mathcal{G}) = B$, and proves that the map from V_{14} to $G = G(2, 6)$ given by the sections of \mathcal{G} and composed with the Plücker embedding is the standard embedding of V_{14} into \mathbb{P}^{14} . Hence \mathcal{G} is isomorphic to the restriction of the universal rank 2 quotient bundle on G (in particular, it has no moduli), and the zero loci of its sections are precisely the sections of V_{14} by the Schubert varieties $\sigma_{11}(L)$ over all hyperplanes $L \subset \mathbb{C}^6 = H^0(\mathcal{G})^\vee$. These zero loci are l. c. i. of pure dimension 1. Indeed, assume the contrary. Assume that $D = \sigma_{11}(L) \cap V_{14}$ has a component of dimension > 1 . Anyway, $\deg D = \deg \sigma_{11}(L) = 5$, hence if $\dim D = 2$, then V_{14} has a divisor of degree $\leq 5 < 14 = \deg V_{14}$. This contradicts the fact that V_{14} has index 1 and Picard number 1. One cannot have $\dim D > 2$, because otherwise V_{14} would be reducible. Hence $\dim D \leq 1$, and it is l. c. i. of pure dimension 1 as the zero locus of a section of a rank 2 vector bundle. All the zero loci B of sections of \mathcal{G} form a component \mathcal{B} of the Hilbert scheme of V_{14} isomorphic to \mathbb{P}^5 .

The curves B from \mathcal{B} passing through x are the sections of V_{14} by the Schubert varieties $\sigma_{11}(L)$ for all L containing the 2-plane S_x represented by the point $x \in G(2, 6)$, and hence form a linear subspace \mathbb{P}^3 in \mathbb{P}^5 .

Now, let us prove the last assertion. Let $C \in Z_2(\Gamma)$ be generic. We have $(C \cdot \Gamma)_{\mathbb{F}_1} = 7$, therefore the map χ , given by the linear system $|\mathcal{O}(8) - 5\Gamma|$, sends it to a curve \tilde{C} of degree $8 \cdot 5 - 5 \cdot 7 = 5$. So, the image is a quintic of genus 1. Let $k = \text{mult}_\xi \tilde{C}$. The inverse χ^{-1} being given by the linear system $|\mathcal{O}(2) - 5\xi|$, we have for the degree of $C = \chi^{-1}(\tilde{C})$: $5 = 2 \deg \tilde{C} - 5k = 10 - 5k$, hence $k = 1$, that is, ξ is a simple point of \tilde{C} . Thus the generic $C \in Z_2(\Gamma)$ is transformed into a smooth elliptic quintic $\tilde{C} \subset V_{14}$ passing through ξ . By the above, such curves form a \mathbb{P}^3 in the Hilbert scheme, and this ends the proof. \square

5.7. PERIOD MAP OF VARIETIES V_{14} . We have seen that one can associate to any Fano variety V_{14} a unique cubic 3-fold X , but to any cubic 3-fold X a 5-dimensional family of varieties V_{14} . Now we are going to determine this 5-dimensional family. This will give also some information on the period map of varieties V_{14} . Let \mathcal{A}_g denote the moduli space of principally polarized abelian varieties of dimension g .

THEOREM 5.8. *Let \mathcal{V}_{14} be the moduli space of smooth Fano 3-folds of degree 14, and let $\Pi : \mathcal{V}_{14} \rightarrow \mathcal{A}_5$ be the period map on \mathcal{V}_{14} . Then the image $\Pi(\mathcal{V}_{14})$ coincides with the 10-dimensional locus \mathcal{J}_5 of intermediate jacobians of cubic threefolds. fiber $\Pi^{-1}(J)$, $J \in \mathcal{J}_5$, is isomorphic to the family $\mathcal{V}(X)$ of the V_{14} which are associated to the same cubic threefold X , and birational to $J^2(X)$.*

Proof. For the construction of \mathcal{V}_{14} and for the fact that $\dim \mathcal{V}_{14} = 15$, see Theorem 0.9 in [Muk].

According to Theorem 2.2, there exists a 5-dimensional family of varieties V_{14} , associated to a fixed generic cubic 3-fold X , which is birationally parametrized by the set M of isomorphism classes of vector bundle \mathcal{E} obtained by Serre's construction starting from normal elliptic quintics $C \subset X$. By Corollary 3.3, M is an open subset of $J^2(X)$. Hence all the assertions follow from Proposition 1.7. □

REFERENCES

- [AC] E. Arrondo, L. Costa, *Vector bundles on Fano 3-folds without intermediate cohomology*, e-print math.AG/9804033.
- [AR] A. Adler, S. Ramanan, *Moduli of Abelian Varieties*, Lect. Notes Math., 1644, Springer-Verlag, 1996.
- [B-MR1] E. Ballico, R. M. Miró-Roig, *Rank 2 stable vector bundles on Fano 3-folds of index 2*, J. Pure Appl. Algebra 120, 213–220 (1997).
- [B-MR2] E. Ballico, R. M. Miró-Roig, *A lower bound for the number of components of the moduli schemes of stable rank 2 vector bundles on projective 3-folds*, Proc. Amer. Math. Soc. 127, 2557–2560 (1999).
- [Barth] W. Barth, *Irreducibility of the space of mathematical instanton bundles with rank 2 and $c_2 = 4$* , Math. Ann. 258, 81–106 (1981/82).
- [BS] D. Bayer, M. Stillman: *Macaulay: A computer algebra system for algebraic geometry*, 1982+, ftp://zariski.harvard.edu (login: anonymous Password: any).
- [B] A. Beauville, *Les singularités du diviseur thêta de la jacobienne intermédiaire de l'hypersurface cubique dans \mathbf{P}^4* , Lecture Notes in Math. 947, 190–208 (1982).
- [BD] A. Beauville, R. Donagi: *La variété des droites d'une hypersurface cubique de dimension 4*, C. R. Acad. Sci. Paris Ser. I Math. 301, no. 14, 703–706(1985).
- [CG] H. Clemens, P. Griffiths, *The intermediate Jacobian of the cubic threefold*, Annals of Math. 95, 281–356 (1972).
- [ES] G. Ellingsrud, S. Strømme, *Stable rank-2 vector bundles on P^3 with $c_1 = 0$ and $c_2 = 3$* , Math. Ann. 255, 123–135 (1981).
- [E-SB] L. Ein, N. Shepherd-Barron, *Some special Cremona transformations*, Amer. J. Math. 111, 783–800 (1989).
- [F] G. Fano, *Sulle sezioni spaziale della varietà grassmanniana delle rette spazio a cinque dimensioni*, Rend. R. Accad. Lincei 11, 329–335(1930).

- [G1] N. Gushel, *Fano varieties of genus 6*, Math. USSR, Izv. 21, 445–459 (1983).
- [G2] N. Gushel, *Fano 3-folds of genus 8*, St. Petersburg. Math. J. 4, 115–129 (1993).
- [H] R. Hartshorne, *Stable vector bundles of rank 2 on P^3* , Math. Ann. 238, 229–280 (1978).
- [HH] R. Hartshorne, A. Hirschowitz, *Smoothing algebraic space curves*, In: Algebraic geometry, Sitges (Barcelona), 1983, Lecture Notes in Math., 1124. Springer, Berlin-New York, 1985, 98–131.
- [Hu] K. Hulek, *Projective geometry of elliptic curves*, Astérisque 137(1986).
- [I] A. I. Iliev, *Minimal sections of conic bundles*, Boll. Uni. Mat. Italiana. (8) 2B, 401-428(1999).
- [IR] A. I. Iliev, K. Ranestad, *$K3$ -surfaces of genus 8 and varieties of sums of powers of cubic fourfolds*, e-print math.AG/9810121, to appear in Trans. Amer. Math. Soc.
- [Isk1] V. A. Iskovskikh, *Birational automorphisms of three-dimensional algebraic varieties*, J. Soviet Math. 13:6, 815-868 (1980)
- [Isk2] V. A. Iskovskikh, *Double projection from a line on Fano threefolds of the first kind*, Math. USSR Sbornik 66, No.1, 265-284 (1990).
- [Isk-P] V. A. Iskovskikh, Yu. G. Prokhorov, *Fano varieties*, Algebraic Geometry V (A. N. Parsin, I. R. Shafarevich, Eds.), Encyclopaedia of Math. Sci., Vol. 47, Springer, Berlin, 1998.
- [LP] J. Le Potier, *Sur l'espace de modules des fibrés de Yang et Mills*, In: Mathematics and physics (Paris, 1979/1982), 65–137, Progr. Math., 37, Birkhäuser, Boston, Mass., 1983.
- [M] D. Markushevich, *Numerical invariants of families of straight lines of Fano manifolds*, Math.USSR, Sbornik 44, 239-260(1983).
- [MT] D. Markushevich, A. S. Tikhomirov, *The Abel-Jacobi map of a moduli component of vector bundles on the cubic threefold*, e-print math.AG/9809140, to appear in J. Alg. Geom.
- [Muk] S. Mukai, *Curves, $K3$ Surfaces and Fano 3-folds of Genus ≤ 10* , in: Algebraic Geometry and Commutative Algebra in Honor of M. Nagata, Kinokuniya, Tokyo 357-377 (1988)
- [OS] G. Ottaviani, M. Szurek, *On moduli of stable 2-bundles with small Chern classes on Q_3* , Ann. Mat. Pura Appl. (IV) 167, 191–241 (1994).
- [P] P. J. Puts, *On some Fano threefolds that are sections of Grassmannians*, Proc. Kon. Ned. Acad. Wet. A 85(1), 77-90 (1982)
- [SW] M. Szurek, J. Wiśniewski, *Conics, conic fibrations and stable vector bundles of rank 2 on some Fano threefolds*, Rev. Roumaine Math. Pures Appl. 38, 729–741 (1993).
- [Tak] K. Takeuchi, *Some birational maps of Fano 3-folds*, Compositio Math. 71, 265-283 (1989).
- [Tre] S. L. Tregub, *Construction of a birational isomorphism of a cubic threefold and Fano variety of the first kind with $g = 8$, associated with a normal rational curve of degree 4*, Moscow Univ. Math. Bull. 40,

78-80 (1985); translation from Vestn. Mosk. Univ., Ser. I 1985, No.6, 99-101 (1985).

- [Tyu] A. N. Tyurin, *Geometry of the Fano surface of a non-singular cubic $F \subset \mathbb{P}^4$ and Torelli theorems for Fano surfaces and cubics*, Izv. USSR Math. 35 (1971), 498–529.

A. Iliev
Inst. of Math.
Bulgarian Acad. of Sci.
Acad. G. Bonchev Str., 8
1113 Sofia, Bulgaria
ailiev@math.bas.bg

D. Markushevich
Mathématiques -
bât. M2, Université Lille 1
F-59655 Villeneuve d'Ascq
Cedex
France
markushe@gat.univ-lille1.fr

A CLASSIFICATION THEOREM
FOR NUCLEAR PURELY INFINITE SIMPLE C^* -ALGEBRAS¹

N. CHRISTOPHER PHILLIPS

Received: January 6, 1998

Revised: December 31, 1999

Communicated by Joachim Cuntz

ABSTRACT. Starting from Kirchberg's theorems announced at the operator algebra conference in Genève in 1994, namely $\mathcal{O}_2 \otimes A \cong \mathcal{O}_2$ for separable unital nuclear simple A and $\mathcal{O}_\infty \otimes A \cong A$ for separable unital nuclear purely infinite simple A , we prove that KK -equivalence implies isomorphism for nonunital separable nuclear purely infinite simple C^* -algebras. It follows that if A and B are unital separable nuclear purely infinite simple C^* -algebras which satisfy the Universal Coefficient Theorem, and if there is a graded isomorphism from $K_*(A)$ to $K_*(B)$ which preserves the K_0 -class of the identity, then $A \cong B$.

Our main technical results are, we believe, of independent interest. We say that two asymptotic morphisms $t \mapsto \varphi_t$ and $t \mapsto \psi_t$ from A to B are asymptotically unitarily equivalent if there exists a continuous unitary path $t \mapsto u_t$ in the unitization B^+ such that $\|u_t \varphi_t(a) u_t^* - \psi_t(a)\| \rightarrow 0$ for all a in A . We prove the following two results on deformations and unitary equivalence. Let A be separable, nuclear, unital, and simple, and let D be unital. Then any asymptotic morphism from A to $K \otimes \mathcal{O}_\infty \otimes D$ is asymptotically unitarily equivalent to a homomorphism, and two homotopic homomorphisms from A to $K \otimes \mathcal{O}_\infty \otimes D$ are necessarily asymptotically unitarily equivalent. We also give some nonclassification results for the nonnuclear case.

1991 Mathematics Subject Classification: Primary 46L35; Secondary 19K99, 46L80.

0 INTRODUCTION

We prove that the isomorphism class of a separable nuclear unital purely infinite simple C^* -algebra satisfying the Rosenberg-Schochet Universal Coefficient Theorem is completely determined by its K -theory. More precisely, let A and

B be separable nuclear unital purely infinite simple C^* -algebras which satisfy the Universal Coefficient Theorem, and suppose that there is a graded isomorphism $\alpha : K_*(A) \rightarrow K_*(B)$ such that $\alpha([1_A]) = [1_B]$ in $K_0(B)$. Then there is an isomorphism $\varphi : A \rightarrow B$ such that $\varphi_* = \alpha$. This theorem follows from a result asserting that whenever A and B are separable nuclear unital purely infinite simple C^* -algebras (not necessarily satisfying the Universal Coefficient Theorem) which are KK -equivalent via a class in KK -theory which respects the classes of the identities, then there is an isomorphism from A to B whose class in KK -theory is the given one.

As intermediate results, we prove some striking facts about homomorphisms and asymptotic morphisms from a separable nuclear unital simple C^* -algebra to the tensor product of a unital C^* -algebra and the Cuntz algebra \mathcal{O}_∞ . If A and D are any two C^* -algebras, we say that two homomorphisms $\varphi, \psi : A \rightarrow D$ are *asymptotically unitarily equivalent* if there is a continuous unitary path $t \mapsto u_t$ in \tilde{D} such that $\lim_{t \rightarrow \infty} u_t \varphi(a) u_t^* = \psi(a)$ for all $a \in A$. (Here $\tilde{D} = D$ if D is unital, and \tilde{D} is the unitization D^+ if D is not unital.) Note that asymptotic unitary equivalence is a slightly strengthened form of approximate unitary equivalence, and is an approximate form of unitary equivalence. Our results show that if A is separable, nuclear, unital, and simple, and D is separable and unital, then $KK^0(A, D)$ can be computed as the set of asymptotic unitary equivalence classes of full homomorphisms from A to $K \otimes \mathcal{O}_\infty \otimes D$, with direct sum as the operation. Note that we use something close to unitary equivalence, and that there is no need to use asymptotic morphisms, no need to take suspensions, and (essentially because \mathcal{O}_∞ is purely infinite) no need to form formal differences of classes. We can furthermore replace A by $K \otimes \mathcal{O}_\infty \otimes A$, in which case the Kasparov product reduces exactly to composition of homomorphisms. These results can be thought of as a form of unsuspected E -theory. (Compare with [16], but note that we don't even need to use asymptotic morphisms.) There are also perturbation results: any asymptotic morphism is in fact asymptotically unitarily equivalent (with a suitable definition) to a homomorphism.

We also present what is now known about how badly the classification fails in the nonnuclear case. There are separable purely infinite simple C^* -algebras A with $\mathcal{O}_\infty \otimes A \not\cong A$ (Dykema–Rørdam), there are infinitely many nonisomorphic separable exact purely infinite simple C^* -algebras A with $\mathcal{O}_\infty \otimes A \cong A$ and $K_*(A) = 0$ (easily obtained from results of Haagerup and Cowling–Haagerup), and for given K -theory there are uncountably many nonisomorphic separable nonexact purely infinite simple C^* -algebras with that K -theory.

Classification of C^* -algebras started with Elliott's classification [19] of AF algebras up to isomorphism by their K -theory. It received new impetus with his successful classification of certain C^* -algebras of real rank zero with nontrivial K_1 -groups. We refer to [21] for a recent comprehensive list of work in this area. The initial step toward classification in the infinite case was taken in [8], and was quickly followed by a number of papers [48], [49], [33], [34], [22], [50], [35], [7], [51], [32], [36]. In July 1994, Kirchberg announced [27] a break-

through: proofs that if A is a separable nuclear unital purely infinite simple C^* -algebra, then $\mathcal{O}_2 \otimes A \cong \mathcal{O}_2$ and $\mathcal{O}_\infty \otimes A \cong A$. (The proofs, closely following Kirchberg's original methods, are in [29].) This quickly led to two more papers [44], [52]. Here, we use Kirchberg's results to nearly solve the classification problem for separable nuclear unital purely infinite simple C^* -algebras; the only difficulty that remains is the Universal Coefficient Theorem. The method is a great generalization of that of [44], in which we replace homomorphisms by asymptotic morphisms and approximate unitary equivalence by asymptotic unitary equivalence. We also need a form of unsuspended E -theory, as alluded to above. The most crucial step is done in Section 2, where we show that, in a particular context, homotopy implies asymptotic unitary equivalence. We suggest reading [44] to understand the basic structure of Section 2.

Kirchberg has in [28] independently derived the same classification theorem we have. His methods are somewhat different, and mostly independent of the proofs in [29]. He proves that homotopy implies a form of unitary equivalence in a different context, and does so by eventually reducing the problem to a theorem of this type in Kasparov's paper [26]. By contrast, the main machinery in our proof is simply the repeated use of Kirchberg's earlier results as described above.

This paper is organized as follows. In Section 1, we present some important facts about asymptotic morphisms, and introduce asymptotic unitary equivalence. In Section 2, we prove our main technical results: under suitable conditions, homotopic asymptotic morphisms are asymptotically unitarily equivalent and asymptotic morphisms are asymptotically unitarily equivalent to homomorphisms. These results are given at the end of the section. In Section 3, we prove the basic form (still using asymptotic morphisms) of our version of unsuspended E -theory. Finally, Section 4 contains the classification theorem and some corollaries, as well as the nicest forms of the intermediate results discussed above. It also contains the nonclassification results.

Most of this work was done during a visit to the Fields Institute for Research in Mathematical Sciences during Fall 1994, and I would like to thank the Institute for its support and for the stimulating research environment it provided. I would also like to thank a number of people for useful discussions, either in person or by electronic mail, including Marius Dădărlat, George Elliott, Uffe Haagerup, Eberhard Kirchberg, Alex Kumjian, Huaxin Lin, Mikael Rørdam, Jonathan Samuel, Claude Schochet, and Shuang Zhang. These discussions have led me to considerable simplification of the arguments and improvement of the terminology. I am also grateful to the referee for a careful reading of the paper and useful suggestions. In addition, the participants of a seminar on an earlier version, including Siegfried Echterhof, Ralf Meyer, Bernhard Neubüser, Christian Valqui, and Wilhelm Winter, made a number of helpful comments.

Throughout this paper, $U(D)$ denotes the unitary group of a unital C^* -algebra D , and $U_0(D)$ denotes the connected component of $U(D)$ containing 1. We will use repeatedly and without comment Cuntz's result that

$K_1(D) = U(D)/U_0(D)$ for a unital purely infinite simple C^* -algebra D , as well as his corresponding result that $K_0(D)$ is the set of Murray-von Neumann equivalence classes of nonzero projections [14]. We similarly use Kasparov's KK -theory [26], and we recall here (and do not mention again) that every separable nonunital purely infinite simple C^* -algebra has the form $K \otimes D$ for a unital purely infinite simple C^* -algebra D [61].

1 ASYMPTOTIC MORPHISMS AND ASYMPTOTIC UNITARY EQUIVALENCE

The basic objects we work with in this paper are asymptotic morphisms. In the first subsection, we state for convenient reference some of the facts we need about asymptotic morphisms, and establish notation concerning them. In the second subsection, we define and discuss full asymptotic morphisms; fullness is used as a nontriviality condition later in the paper. In the third subsection, we introduce asymptotic unitary equivalence of asymptotic morphisms. This relation is the appropriate version of unitary equivalence in the context of asymptotic morphisms, and will play a fundamental role in Sections 2 and 3.

1.1 ASYMPTOTIC MORPHISMS AND ASYMPTOTIC UNITARY EQUIVALENCE

Asymptotic morphisms were introduced by Connes and Higson [11] for the purpose of defining E -theory, a simple construction of KK -theory (at least if the first variable is nuclear). In this subsection, we recall the definition and some of the basic results on asymptotic morphisms, partly to establish our notation and partly for ease of reference. We also prove a few facts that are well known but seem not to have been published. We refer to [11], and the much more detailed paper [54], for the details of the rest of the development of E -theory.

If X is a compact Hausdorff Hausdorff space, then $C(X, D)$ denotes the C^* -algebra of all continuous functions from X to D , while if X is locally compact Hausdorff Hausdorff, then $C_0(X, D)$ denotes the C^* -algebra of all continuous functions from X to D which vanish at infinity, and $C_b(X, D)$ denote the C^* -algebra of all bounded continuous functions from X to D .

We begin by recalling the definition of an asymptotic morphism.

1.1.1 DEFINITION. Let A and D be C^* -algebras, with A separable. An *asymptotic morphism* $\varphi: A \rightarrow D$ is a family $t \rightarrow \varphi_t$ of functions from A to D , defined for $t \in [0, \infty)$, satisfying the following conditions:

- (1) For every $a \in A$, the function $t \mapsto \varphi_t(a)$ is continuous from $[0, \infty)$ to D .
- (2) For every $a, b \in A$ and $\alpha, \beta \in \mathbf{C}$, the limits

$$\lim_{t \rightarrow \infty} (\varphi_t(\alpha a + \beta b) - \alpha \varphi_t(a) - \beta \varphi_t(b)),$$

$$\lim_{t \rightarrow \infty} (\varphi_t(ab) - \varphi_t(a)\varphi_t(b)), \quad \text{and} \quad \lim_{t \rightarrow \infty} (\varphi_t(a^*) - \varphi_t(a)^*)$$

are all zero.

1.1.2 DEFINITION. ([11]) Let φ and ψ be asymptotic morphisms from A to D .

(1) We say that φ and ψ are *asymptotically equal* (called “equivalent” in [11]) if for all $a \in A$, we have $\lim_{t \rightarrow \infty} (\varphi_t(a) - \psi_t(a)) = 0$.

(2) We say that φ and ψ are *homotopic* if there is an asymptotic morphism $\rho : A \rightarrow C([0, 1], D)$ whose restrictions to $\{0\}$ and $\{1\}$ are φ and ψ respectively. In this case, we refer to $\alpha \mapsto \rho^{(\alpha)} = \text{ev}_\alpha \circ \rho$ (where $\text{ev}_\alpha : C([0, 1], D) \rightarrow D$ is evaluation at α) as a homotopy from φ to ψ , or as a continuous path of asymptotic morphisms from φ to ψ .

The set of homotopy classes of asymptotic morphisms from A to D is denoted $[[A, D]]$, and the homotopy class of an asymptotic morphism φ is denoted $[[\varphi]]$.

It is easy to check that asymptotic equality implies homotopy ([54], Remark 1.11).

1.1.3 DEFINITION. Let $\varphi, \psi : A \rightarrow K \otimes D$ be asymptotic morphisms. The direct sum $\varphi \oplus \psi$, well defined up to unitary equivalence (via unitaries in $M(K \otimes D)$), is defined as follows. Choose any isomorphism $\delta : M_2(K) \rightarrow K$, let $\bar{\delta} : M_2(K \otimes D) \rightarrow K \otimes D$ be the induced map, and define

$$(\varphi \oplus \psi)_t(a) = \bar{\delta} \left(\begin{pmatrix} \varphi_t(a) & 0 \\ 0 & \psi_t(a) \end{pmatrix} \right).$$

Note that any two choices for δ are unitarily equivalent (and hence homotopic).

The individual maps φ_t of an asymptotic morphism are not assumed bounded or even linear.

1.1.4 DEFINITION. Let $\varphi : A \rightarrow D$ be an asymptotic morphism.

(1) We say that φ is *completely positive contractive* if each φ_t is a linear completely positive contraction.

(2) We say that φ is *bounded* if each φ_t is linear and $\sup_t \|\varphi_t\|$ is finite.

(3) We say that φ is *selfadjoint* if $\varphi_t(a^*) = \varphi_t(a)^*$ for all t and a .

Unless otherwise specified, homotopies of asymptotic morphisms from A to D satisfying one or more of these conditions will be assumed to satisfy the same conditions as asymptotic morphisms from A to $C([0, 1], D)$.

Note that if φ is bounded, then the formula $\psi_t(a) = \frac{1}{2}(\varphi_t(a) + \varphi_t(a^*)^*)$ defines a selfadjoint bounded asymptotic morphism which is asymptotically equal to φ . We omit the easy verification that ψ is in fact an asymptotic morphism.

1.1.5 LEMMA. ([54], Lemma 1.6.) Let A and D be C*-algebras, with A separable and nuclear. Then every asymptotic morphism from A to D is asymptot-

ically equal to a completely positive contractive asymptotic morphism. Moreover, the obvious map defines a bijection between the sets of homotopy classes of completely positive contractive asymptotic morphisms and arbitrary asymptotic morphisms. (Homotopy classes are as in the convention in Definition 1.1.4.)

1.1.6 LEMMA. Let $\varphi : A \rightarrow D$ be an asymptotic morphism. Define $\varphi^+ : A^+ \rightarrow D^+$ by $\varphi_t(a + \lambda \cdot 1) = \varphi_t(a) + \lambda \cdot 1$ for $a \in A$ and $\lambda \in \mathbf{C}$. Then φ^+ is an asymptotic morphism from A^+ to D^+ , and is completely positive contractive, bounded, or selfadjoint whenever φ is.

The proof of this is straightforward, and is omitted.

The following result is certainly known, but we know of no reference.

1.1.7 PROPOSITION. Let A be a C^* -algebra which is given by exactly stable (in the sense of Loring [37]) generators and relations (G, R) , with both G and R finite. Let D be a C^* -algebra. Then any asymptotic morphism from A to D is asymptotically equal to a continuous family of homomorphisms from A to D (parametrized by $[0, \infty)$). Moreover, if $\varphi^{(0)}$ and $\varphi^{(1)}$ are two homotopic asymptotic morphisms from A to D , such that each $\varphi_t^{(0)}$ and each $\varphi_t^{(1)}$ is a homomorphism, then there is a homotopy $\alpha \mapsto \varphi^{(\alpha)}$ which is asymptotically equal to the given homotopy and such that each $\varphi_t^{(\alpha)}$ is a homomorphism.

Note that it follows from Theorem 2.6 of [38] that exact stability of (G, R) depends only on A , not on the specific choices of G and R .

Proof of Proposition 1.1.7: Theorem 2.6 of [38] implies that the algebra A is semiprojective in the sense of Blackadar [4]. (Also see Definition 2.3 of [38].) We will use semiprojectivity instead of exact stability.

We prove the first statement. Let $\varphi : A \rightarrow D$ be an asymptotic morphism. Then φ defines in a standard way (see Section 1.2 of [54]) a homomorphism $\psi : A \rightarrow C_b([0, \infty), D)/C_0([0, \infty), D)$. Let

$$I_n(D) = \{f \in C_b([0, \infty), D) : f(t) = 0 \text{ for } t \geq n\}.$$

Then $C_0([0, \infty), D) = \overline{\bigcup_{n=1}^{\infty} I_n(D)}$. Semiprojectivity of A provides an n and a homomorphism $\sigma : A \rightarrow C_b([0, \infty), D)/I_n(D)$ such that the composite of σ and the quotient map

$$C_b([0, \infty), D)/I_n(D) \rightarrow C_b([0, \infty), D)/C_0([0, \infty), D)$$

is ψ . Now σ can be viewed as a continuous family of homomorphisms σ_t from A to D , parametrized by $[n, \infty)$. Define $\sigma_t = \sigma_n$ for $0 \leq t \leq n$. This gives the required continuous family of homomorphisms.

The proof of the statement about homotopies is essentially the same. We use $C_b([0, 1] \times [0, \infty), D)$ in place of $C_b([0, \infty), D)$,

$$J = \{f \in C_0([0, 1] \times [0, \infty), D) : f(\alpha, t) = 0 \text{ for } \alpha = 0, 1\}$$

in place of $C_0([0, \infty), D)$, and $J \cap I_n([0, 1], D)$ in place of $I_n(D)$. We obtain $\varphi_t^{(\alpha)}$ for all t greater than or equal to some t_0 , and for all t when $\alpha = 0$ or 1 . We then extend over $(0, 1) \times [0, t_0)$ via a continuous retraction

$$[0, 1] \times [0, \infty) \rightarrow ([0, 1] \times [t_0, \infty)) \cup (\{0\} \times [0, \infty)) \cup (\{1\} \times [0, \infty)).$$

□

We refer to [11] (and to [54] for more detailed proofs) for the definition of $E(A, B)$ as the abelian group of homotopy classes of asymptotic morphisms from $K \otimes SA$ to $K \otimes SB$, for the construction of the composition of asymptotic morphisms (well defined up to homotopy), and for the construction of the natural map $KK^0(A, B) \rightarrow E(A, B)$ and the fact that it is an isomorphism if A is nuclear. We do state here for reference the existence of the tensor product of asymptotic morphisms. For the proof, see Section 2.2 of [54].

1.1.8 PROPOSITION. ([11]) Let A_1, A_2, B_1 , and B_2 be separable C^* -algebras, and let $\varphi^{(i)} : A_i \rightarrow B_i$ be asymptotic morphisms. Then there exists an asymptotic morphism $\psi : A_1 \otimes A_2 \rightarrow B_1 \otimes B_2$ (maximal tensor products) such that $\psi_t(a_1 \otimes a_2) - \varphi_t^{(1)}(a_1) \otimes \varphi_t^{(2)}(a_2) \rightarrow 0$ as $t \rightarrow \infty$, for all $a_1 \in A_1$ and $a_2 \in A_2$. Moreover, ψ is unique up to asymptotic equality.

1.2 FULL ASYMPTOTIC MORPHISMS

In this subsection, we define full asymptotic morphisms. Fullness will be used as a nontriviality condition on asymptotic morphisms in Section 3. It will also be convenient (although not, strictly speaking, necessary) in Section 2.

We make our definitions in terms of projections, because the behavior of asymptotic morphisms on projections can be reasonably well controlled. We do not want to let the asymptotic morphism $\varphi : C_0(\mathbf{R}) \rightarrow C_0(\mathbf{R})$, defined by $\varphi_t(f) = tf$, be considered to be full, since it is asymptotically equal to the zero asymptotic morphism, but in the absence of projections it is not so clear how to rule it out. Fortunately, in the present paper this issue does not arise.

We start with a useful definition and some observations related to the evaluation of asymptotic morphisms on projections.

1.2.1 DEFINITION. Let A and D be C^* -algebras, with A separable. Let $p \in A$ be a projection, and let $\varphi : A \rightarrow D$ be an asymptotic morphism. A *tail projection* for $\varphi(p)$ is a continuous function $t \mapsto q_t$ from $[0, \infty)$ to the projections in D which, thought of as an asymptotic morphism $\psi : \mathbf{C} \rightarrow D$ via $\psi_t(\lambda) = \lambda q_t$, is asymptotically equal to the asymptotic morphism $\psi'_t(\lambda) = \lambda \varphi_t(p)$.

1.2.2 REMARK. (1) Tail projections always exist: Choose a suitable t_0 , apply functional calculus to $\frac{1}{2}(\varphi_t(p) + \varphi_t(p)^*)$ for $t \geq t_0$, and take the value at t for $t \leq t_0$ to be the value at t_0 . (Or use Proposition 1.1.7.)

(2) If φ is an asymptotic morphism from A to D , then a tail projection for $\varphi(p)$, regarded as an asymptotic morphism from \mathbf{C} to D , is a representative of the product homotopy class of φ and the asymptotic morphism from \mathbf{C} to A given by p .

(3) A *homotopy* of tail projections is defined in the obvious way: it is a continuous family of projections $(\alpha, t) \rightarrow q_t^{(\alpha)}$ with given values at $\alpha = 0$ and $\alpha = 1$.

(4) If φ is an asymptotic morphism, then it makes sense to say that a tail projection is (or is not) full (that is, generates a full hereditary subalgebra), since fullness depends only on the homotopy class of a projection.

1.2.3 LEMMA. Let A and D be C^* -algebras, with A separable. Let $\varphi : A \rightarrow D$ be an asymptotic morphism, and let p_1 and p_2 be projections in A . If p_1 is Murray-von Neumann equivalent to a subprojection of p_2 , then a tail projection for $\varphi(p_1)$ is Murray-von Neumann equivalent to a subprojection of a tail projection for $\varphi(p_2)$.

Proof: Let $t \mapsto q_t^{(1)}$ and $t \mapsto q_t^{(2)}$ be tail projections for $\varphi(p_1)$ and $\varphi(p_2)$ respectively. Let v be a partial isometry with $v^*v = p_1$ and $vv^* \leq p_2$. Using asymptotic multiplicativity and the definition of a tail projection, we have

$$\lim_{t \rightarrow \infty} \left(\varphi_t(v)^* \varphi_t(v) - q_t^{(1)} \right) = 0 \quad \text{and} \quad \lim_{t \rightarrow \infty} \left(q_t^{(2)} \varphi_t(v) \varphi_t(v)^* q_t^{(2)} - q_t^{(2)} \right) = 0.$$

It follows that for t sufficiently large, $q_t^{(1)}$ is Murray-von Neumann equivalent to a subprojection of $q_t^{(2)}$, with the Murray-von Neumann equivalence depending continuously on t . It is easy to extend it from an interval $[t_0, \infty)$ to $[0, \infty)$. \square

1.2.4 LEMMA. Let A and D be as in Definition 1.2.1, let $\alpha \mapsto \varphi^{(\alpha)}$ be a homotopy of asymptotic morphisms from A to D , and let $p_0, p_1 \in A$ be homotopic projections. Let $q^{(0)}$ and $q^{(1)}$ be tail projections for $\varphi^{(0)}(p_0)$ and $\varphi^{(1)}(p_1)$ respectively. Then $q^{(0)}$ is homotopic to $q^{(1)}$ in the sense of Remark 1.2.1 (3).

Proof: This can be proved directly, but also follows by combining Remark 1.2.2 (2), Proposition 1.1.7, and the fact that products of homotopy classes of asymptotic morphisms are well defined. \square

1.2.5 DEFINITION. Let A be a separable C^* -algebra which contains a full projection, and let D be any C^* -algebra. Then an asymptotic morphism $\varphi : A \rightarrow D$ is *full* if there is a full projection $p \in A$ such that some (equivalently, any) tail projection for $\varphi(p)$ is full in D .

This definition rejects, not only the identity map of $C_0(\mathbf{R})$, but also the identity map of $C_0(\mathbf{Z})$. (The algebra $C_0(\mathbf{Z})$ has no full projections.) However, it will do for our purposes.

Note that, by Lemma 1.2.3, if a tail projection for $\varphi(p)$ is full, then so is a tail projection for $\varphi(q)$ whenever p is Murray-von Neumann equivalent to a subprojection of q .

We now list the relevant properties of full asymptotic morphisms. We omit the proofs; they are mostly either immediate or variations on the proof of Lemma 1.2.3.

1.2.6 LEMMA. (1) Fullness of an asymptotic morphism depends only on its homotopy class.

(2) If $\varphi, \psi : A \rightarrow D$ are asymptotic morphisms, and if φ is full, then so is the asymptotic morphism $\varphi \oplus \psi : A \rightarrow M_2(D)$.

(3) Let B be separable, and have a full projection, and further assume that given two full projections in B , each is Murray-von Neumann equivalent to a subprojection of the other. Then any asymptotic morphism representing the product of full asymptotic morphisms from A to B and from B to D is again full.

The extra assumption in part (3) is annoying, but we don't see an easy way to avoid it. This suggests that we don't quite have the right definition. However, in this paper B will almost always have the form $K \otimes \mathcal{O}_\infty \otimes D$ with D unital. Lemma 2.1.8 (1) below will ensure that the assumption holds in this case.

1.3 ASYMPTOTIC UNITARY EQUIVALENCE

Approximately unitarily equivalent homomorphisms have the same class in Rørdam's KL -theory (Proposition 5.4 of [51]), but need not have the same class in KK -theory. (See Theorem 6.12 of [51], and note that $KL(A, B)$ is in general a proper quotient of $KK^0(A, B)$.) Since the theorems we prove in Section 3 give information about KK -theory rather than about Rørdam's KL -theory, we introduce and use the notion of asymptotic unitary equivalence instead. We give the definition for asymptotic morphisms because we will make extensive technical use of it in this context, but, for reasons to be explained below, it is best suited to homomorphisms.

1.3.1 DEFINITION. Let A and D be C^* -algebras, with A separable. Let $\varphi, \psi : A \rightarrow D$ be two asymptotic morphisms. Then φ is *asymptotically unitarily equivalent* to ψ if there is a continuous family of unitaries $t \mapsto u_t$ in \tilde{D} , defined for $t \in [0, \infty)$, such that

$$\lim_{t \rightarrow \infty} \|u_t \varphi_t(a) u_t^* - \psi_t(a)\| = 0$$

for all $a \in A$. We say that two homomorphisms $\varphi, \psi : A \rightarrow D$ are *asymptotically unitarily equivalent* if the corresponding constant asymptotic morphisms with $\varphi_t = \varphi$ and $\psi_t = \psi$ are asymptotically unitarily equivalent.

1.3.2 LEMMA. Asymptotic unitary equivalence is the equivalence relation on asymptotic morphisms generated by asymptotic equality and unitary equivalence in the exact sense (that is, $u_t \varphi_t(a) u_t^* = \psi_t(a)$ for all $a \in A$).

Proof: The only point needing any work at all is transitivity of asymptotic unitary equivalence, and this is easy. \square

1.3.3 LEMMA. Let A and D be C^* -algebras, with A separable.

(1) Let $\varphi, \psi : A \rightarrow K \otimes D$ be asymptotically unitarily equivalent asymptotic morphisms. Then φ is homotopic to ψ .

(2) Let $\varphi, \psi : A \rightarrow K \otimes D$ be asymptotically unitarily equivalent homomorphisms. Then φ is homotopic to ψ via a path of homomorphisms.

Proof: (1) Let $t \mapsto u_t \in (K \otimes D)^+$ be an asymptotic unitary equivalence. Modulo the usual isomorphism $M_2(K) \cong K$, the asymptotic morphisms φ and ψ are homotopic to the asymptotic morphisms $\varphi \oplus 0$ and $\psi \oplus 0$ from A to $M_2(K \otimes D)$. Choose a continuous function $(\alpha, t) \mapsto v_{\alpha,t}$ from $[0, 1] \times [0, \infty)$ to $U(M_2((K \otimes D)^+))$ such that $v_{0,t} = 1$ and $v_{1,t} = u_t \oplus u_t^*$ for all t . Define a homotopy of asymptotic morphisms by $\rho_t^{(\alpha)}(a) = v_{\alpha,t}(\varphi_t(a) \oplus 0)v_{\alpha,t}^*$. Then $\rho^{(0)} = \varphi \oplus 0$ and $\rho^{(1)}$ is asymptotically equal to $\psi \oplus 0$. So φ is homotopic to ψ .

(2) Apply the proof of part (1) to the constant paths $t \mapsto \varphi$ and $t \mapsto \psi$. Putting $t = 0$ gives homotopies of homomorphisms from φ to $\rho_0^{(1)}$ and from ψ to $\psi \oplus 0$. The remaining piece of our homotopy is taken to be defined for $t \in [0, \infty]$, and is given by $t \mapsto \rho_t^{(1)}$ for $t \in [0, \infty)$ and $\infty \mapsto \psi \oplus 0$. \square

1.3.4 COROLLARY. Two asymptotically unitarily equivalent asymptotic morphisms define the same class in E -theory.

If the domain is nuclear, this corollary shows that asymptotically unitarily equivalent asymptotic morphisms define the same class in KK -theory. Asymptotic unitary equivalence thus rectifies the most important disadvantage of approximate unitary equivalence for homomorphisms. Asymptotic unitary equivalence, however, also has its problems, connected with the extension to asymptotic morphisms. The construction of the product of asymptotic morphisms requires reparametrization of asymptotic morphisms, as in the following definition.

1.3.5 DEFINITION. Let A and D be C^* -algebras, and let $\varphi : A \rightarrow D$ be an asymptotic morphism. A *reparametrization* of φ is an asymptotic morphism from A to D of the form $t \mapsto \varphi_{f(t)}$ for some continuous nondecreasing function $f : [0, \infty) \rightarrow [0, \infty)$ such that $\lim_{t \rightarrow \infty} f(t) = \infty$.

Other versions are possible: one could replace “nondecreasing” by “strictly increasing”, or omit this condition entirely. The version we give is the most convenient for our purposes.

It is not in general true that an asymptotic morphism is asymptotically unitarily equivalent to its reparametrizations. (Consider, for example, the asymptotic morphism $\varphi : C(S^1) \rightarrow \mathbf{C}$ given by $\varphi_t(f) = f(\exp(it))$.) The product is thus not defined on asymptotic unitary equivalence classes of asymptotic morphisms. (The product is defined on asymptotic unitary equivalence classes

when one factor is a homomorphism. We don't prove this fact because we don't need it, but see the last part of the proof of Lemma 2.3.5.) In fact, if an asymptotic morphism is asymptotically unitarily equivalent to its reparametrizations, then it is asymptotically unitarily equivalent to a homomorphism, and this will play an important role in our proof. The observation that this is true is due to Kirchberg. It replaces a more complicated argument in the earlier version of this paper, which involved the use throughout of "local asymptotic morphisms", a generalization of asymptotic morphisms in which there is another parameter. We start the proof with a lemma.

1.3.6 LEMMA. Let A and D be C^* -algebras, and let $\varphi : A \rightarrow D$ be an asymptotic morphism. Suppose φ is asymptotically unitarily equivalent to all its reparametrizations. Then for any $\varepsilon > 0$ and any finite set $F \subset A$ there is $M \in [0, \infty)$ such that for any compact interval $I \subset \mathbf{R}$ and any continuous nondecreasing functions $f, g : I \rightarrow [M, \infty)$, there is a continuous unitary path $t \mapsto v_t$ in \tilde{D} satisfying $\|v_t \varphi_{f(t)}(a) v_t^* - \varphi_{g(t)}(a)\| < \varepsilon$ for all $t \in I$ and $a \in F$.

Proof: Suppose the lemma is false. We can obviously change I at will by reparametrizing, so there are $\varepsilon > 0$ and $F \subset A$ finite such that for all $M \in [0, \infty)$ and all compact intervals $I \subset \mathbf{R}$ there are continuous nondecreasing functions $f, g : I \rightarrow [M, \infty)$ for which no continuous unitary path $t \mapsto v_t$ in \tilde{D} gives $\|v_t \varphi_{f(t)}(a) v_t^* - \varphi_{g(t)}(a)\| < \varepsilon$ for $t \in I$ and $a \in F$. Choose f_1 and g_1 for $M = M_1 = 1$ and $I = I_1 = [1, 1 + \frac{1}{2}]$. Given f_n and g_n , choose f_{n+1} and g_{n+1} as above for $M = M_{n+1} = 1 + \max(f_n(n + \frac{1}{2}), g_n(n + \frac{1}{2}))$ and $I = I_{n+1} = [n + 1, n + 1 + \frac{1}{2}]$. By induction, we have $M_n \geq n$. Let $f, g : [0, \infty) \rightarrow [0, \infty)$ be the unique continuous functions which are linear on the intervals $[n + \frac{1}{2}, n + 1]$ and satisfy $f|_{[n, n + \frac{1}{2}]} = f_n$ and $g|_{[n, n + \frac{1}{2}]} = g_n$. Since f and g are nondecreasing and satisfy $f(t), g(t) \geq n$ for $t \geq n$, the functions $t \mapsto \varphi_{f(t)}$ and $t \mapsto \varphi_{g(t)}$ are asymptotic morphisms which are reparametrizations of φ . By hypothesis, both are asymptotically unitarily equivalent to φ , and are therefore also asymptotically unitarily equivalent to each other. Let $t \mapsto v_t$ be a unitary path in \tilde{D} which implements this asymptotic unitary equivalence. Choose T such that for $a \in F$ and $t > T$ we have $\|v_t \varphi_{f(t)}(a) v_t^* - \varphi_{g(t)}(a)\| < \varepsilon/2$. Restricting to $[n, n + \frac{1}{2}]$ for some $n > T$ gives a contradiction to the choice of M and ε . This proves the lemma. \square

1.3.7 PROPOSITION. Let A be a separable C^* -algebra, and let $\varphi : A \rightarrow D$ be a bounded asymptotic morphism. Suppose that φ is asymptotically unitarily equivalent to all its reparametrizations. Then φ is asymptotically unitarily equivalent to a homomorphism. That is, there exist a homomorphism $\omega : A \rightarrow D$ and a continuous path $t \mapsto v_t$ of unitaries in \tilde{D} such that for every $a \in A$, we have $\lim_{t \rightarrow \infty} v_t \varphi_t(a) v_t^* = \omega(a)$.

Recall from Definition 1.1.4 (2) that bounded asymptotic morphisms are assumed in particular to be linear.

Proof of Proposition 1.3.7: Choose finite sets $F_0 \subset F_1 \subset \dots \subset A$ whose union is dense in A . Choose a sequence $t_0 < t_1 < \dots$, with $t_n \rightarrow \infty$, such that

$$\|\varphi_t(ab) - \varphi_t(a)\varphi_t(b)\|, \|\varphi_t(a^*) - \varphi_t(a)^*\| < 1/2^n$$

for $a, b \in F_n$ and $t \geq t_n$, and also such that, as in the previous lemma, for any compact interval $I \subset \mathbf{R}$ and any continuous nondecreasing functions $f, g : I \rightarrow [t_n, \infty)$, there is a continuous unitary path $t \mapsto v_t$ in \tilde{D} satisfying $\|v_t \varphi_{f(t)}(a) v_t^* - \varphi_{g(t)}(a)\| < 2^{-n-1}$ for all $t \in I$ and $a \in F_n$. For $n \geq 0$ let $t \mapsto u_t^{(n)}$ be the unitary path associated with the particular choices $I = [t_n, t_{n+1}]$, $f(t) = t$, and $g(t) = t_n$. Set $\tilde{u}_t^{(n)} = (u_{t_n}^{(n)})^* u_t^{(n)}$. We have $\|(u_{t_n}^{(n)})^* \varphi_{t_n}(a) u_{t_n}^{(n)} - \varphi_{t_n}(a)\| < 2^{-n-1}$ for $a \in F_n$, so $\|\tilde{u}_t^{(n)} \varphi_t(a) (\tilde{u}_t^{(n)})^* - \varphi_{t_n}(a)\| < 2^{-n}$ for $t \in [t_n, t_{n+1}]$ and $a \in F_n$. Also note that $\tilde{u}_{t_n}^{(n)} = 1$. Now define a continuous unitary function $[0, \infty) \rightarrow \tilde{D}$ by

$$v_t = \tilde{u}_{t_1}^{(0)} \cdot \tilde{u}_{t_2}^{(1)} \cdots \tilde{u}_{t_n}^{(n-1)} \cdot \tilde{u}_t^{(n)}$$

for $t_n \leq t \leq t_{n+1}$.

We claim that $\omega(a) = \lim_{t \rightarrow \infty} v_t \varphi_t(a) v_t^*$ exists for all $a \in A$. Since $\sup_{t \in [0, \infty)} \|\varphi_t\| < \infty$, it suffices to check this on the dense subset $\bigcup_{k=0}^{\infty} F_k$. So let $a \in F_k$. We prove that the net $t \mapsto v_t \varphi_t(a) v_t^*$ is Cauchy. Let $m \geq k$, and let $t \geq t_m$. Choose n such that $t_n \leq t \leq t_{n+1}$. Then

$$\begin{aligned} & \|v_t \varphi_t(a) v_t^* - v_{t_m} \varphi_{t_m}(a) v_{t_m}^*\| \\ &= \left\| \left[\tilde{u}_{t_{m+1}}^{(m)} \cdot \tilde{u}_{t_{m+2}}^{(m+1)} \cdots \tilde{u}_{t_n}^{(n-1)} \cdot \tilde{u}_t^{(n)} \right] \right. \\ & \quad \left. \varphi_t(a) \left[\tilde{u}_{t_{m+1}}^{(m)} \cdot \tilde{u}_{t_{m+2}}^{(m+1)} \cdots \tilde{u}_{t_n}^{(n-1)} \cdot \tilde{u}_t^{(n)} \right]^* - \varphi_{t_m}(a) \right\| \\ & \leq \left\| \left(\tilde{u}_t^{(n)} \right) \varphi_t(a) \left(\tilde{u}_t^{(n)} \right)^* - \varphi_{t_n}(a) \right\| \\ & \quad + \sum_{j=m}^{n-1} \left\| \left(\tilde{u}_{t_{j+1}}^{(j)} \right) \varphi_{t_{j+1}}(a) \left(\tilde{u}_{t_{j+1}}^{(j)} \right)^* - \varphi_{t_j}(a) \right\| \\ & \leq \sum_{j=m}^n \frac{1}{2^j} < \frac{1}{2^{m-1}}. \end{aligned}$$

Therefore, if $r, t \geq t_m$, we obtain

$$\|v_r \varphi_r(a) v_r^* - v_t \varphi_t(a) v_t^*\| < 1/2^{m-2}.$$

So we have a Cauchy net, which must converge. The claim is now proved.

Since φ_t is multiplicative and $*$ -preserving to within 2^{-n} on F_n for $t \geq t_n$, it follows that ω is exactly multiplicative and $*$ -preserving on each F_n . Since $\|\omega\| \leq \sup_{t \in [0, \infty)} \|\varphi_t\| < \infty$, it follows that ω is a homomorphism. \square

In the rest of this section, we prove some useful facts about asymptotic unitary equivalence.

1.3.8 LEMMA. Let $\varphi : A \rightarrow D$ be an asymptotic morphism, with A unital. Then there is a projection $p \in D$ and an asymptotic morphism $\psi : A \rightarrow D$ which is asymptotically unitarily equivalent to φ and satisfies $\psi_t(1) = p$ and $\psi_t(a) \in pDp$ for all $t \in [0, \infty)$ and $a \in A$.

Proof: Let $t \mapsto q_t$ be a tail projection for $\varphi(1)$, as in Definition 1.2.1. Standard results yield a continuous family of unitaries $t \mapsto u_t$ in \tilde{D} such that $u_0 = 1$ and $u_t q_t u_t^* = q_0$ for all $t \in [0, \infty)$. Define $p = q_0$ and define $\rho_t(a) = u_t q_t \varphi_t(a) q_t u_t^*$ for $t \in [0, \infty)$ and $a \in A$. Note that the definition of an asymptotic morphism implies that $(t, a) \mapsto q_t \varphi_t(a) q_t$ is asymptotically equal to φ , and hence is an asymptotic morphism. Thus ρ is an asymptotic morphism which is asymptotically unitarily equivalent to φ .

The only problem is that $\rho_t(1)$ might not be equal to p . We do know that $\rho_t(1) \rightarrow p$ as $t \rightarrow \infty$. Choose a closed subspace A_0 of A which is complementary to $\mathbf{C} \cdot 1$, and for $a \in A_0$ and $\lambda \in \mathbf{C}$ define $\psi_t(a + \lambda \cdot 1) = \rho_t(a) + \lambda p$. \square

1.3.9 LEMMA. Let $\varphi, \psi : A \rightarrow K \otimes D$ be asymptotic morphisms, with A and D unital. Suppose that there is a continuous family of unitaries $t \mapsto u_t$ in the multiplier algebra $M(K \otimes D)$ such that $\lim_{t \rightarrow \infty} \|u_t \varphi_t(a) u_t^* - \psi_t(a)\| = 0$ for all $a \in A$. Then φ is asymptotically unitarily equivalent to ψ .

Proof: We have to show that u_t can be replaced by $v_t \in (K \otimes D)^+$.

Applying the previous lemma twice, and making the corresponding modifications to the given u_t , we may assume that $\varphi_t(1)$ and $\psi_t(1)$ are projections p and q not depending on t , and that we always have $\varphi_t(a) \in pDp$ and $\psi_t(a) \in qDq$.

We now want to reduce to the case $p = q$. The hypothesis implies that there is t_0 such that $\|u_{t_0} p u_{t_0}^* - q\| < 1/2$. Therefore there is a unitary w in $(K \otimes D)^+$ such that $w u_{t_0} p u_{t_0}^* w^* = q$. Now if $p, q \in K \otimes D$ are projections which are unitarily equivalent in $M(K \otimes D)$, then standard arguments show they are unitarily equivalent in $(K \otimes D)^+$. Therefore conjugating φ by $w u_{t_0}$ changes neither its asymptotic unitary equivalence class nor the validity of the hypotheses. We may thus assume without loss of generality that $p = q$.

Now choose t_1 such that $t \geq t_1$ implies $\|u_t p u_t^* - p\| < 1$. Define a continuous family of unitaries by

$$c_t = 1 - p + p u_t p (p u_t^* p u_t p)^{-1/2} \in (K \otimes D)^+$$

for $t \geq t_1$. (Functional calculus is evaluated in $p(K \otimes D)p$.) For any $d \in p(K \otimes D)p$, we have

$$\begin{aligned} \|c_t d c_t^* - u_t d u_t^*\| &= \|p d p - c_t^* u_t p d p u_t^* c_t\| \\ &\leq 2 \|d\| \|p - c_t^* u_t p\| \leq 2 \|d\| (\|u_t p - p u_t\| + \|p - c_t^* p u_t p\|). \end{aligned}$$

The first summand in the last factor goes to 0 as $t \rightarrow \infty$. Substituting definitions, the second summand becomes $\|p - (p u_t^* p u_t p)^{1/2}\|$, which does the same.

Since $\varphi_t(a) \in p(K \otimes D)p$ for all $a \in A$, and since (using Lemma 1.2 of [54] for the first)

$$\limsup_{t \rightarrow \infty} \|\varphi_t(a)\| \leq \|a\| \quad \text{and} \quad \lim_{t \rightarrow \infty} \|u_t \varphi_t(a) u_t^* - \psi_t(a)\| = 0,$$

it follows that $\lim_{t \rightarrow \infty} \|c_t \varphi_t(a) c_t^* - \psi_t(a)\| = 0$ as well. This is the desired asymptotic unitary equivalence. \square

2 ASYMPTOTIC MORPHISMS TO TENSOR PRODUCTS WITH \mathcal{O}_∞ .

The purpose of this section is to prove two things about asymptotic morphisms from a separable nuclear unital simple C^* -algebra A to a C^* -algebra of the form $K \otimes \mathcal{O}_\infty \otimes D$ with D unital: homotopy implies asymptotic unitary equivalence, and each such asymptotic morphism is asymptotically unitarily equivalent to a homomorphism. The basic method is the absorption technique used in [35] and [44], and in fact this section is really just the generalization of [44] from homomorphisms and approximate unitary equivalence to asymptotic morphisms and asymptotic unitary equivalence.

There are three subsections. In the first, we collect for reference various known results involving Cuntz algebras (including in particular Kirchberg's theorems on tensor products) and derive some easy consequences. In the second subsection, we replace approximate unitary equivalence by asymptotic unitary equivalence in the results of [48] and [35]. In the third, we carry out the absorption argument and derive its consequences.

The arguments involving asymptotic unitary equivalence instead of approximate unitary equivalence are sometimes somewhat technical. However, the essential outline of the proof is the same as in the much easier to read paper [44].

2.1 PRELIMINARIES: CUNTZ ALGEBRAS AND KIRCHBERG'S STABILITY THEOREMS

In this subsection, we collect for convenient reference various results related to Cuntz algebras. Besides Rørdam's results on approximate unitary equivalence and Kirchberg's basic results on tensor products, we need material on unstable K -theory and hereditary subalgebras of tensor products with \mathcal{O}_∞ and on exact stability of generating relations of Cuntz algebras.

We start with Rørdam's work [48]; we also use this opportunity to establish our notation. The first definition is used implicitly by Rørdam, and appears explicitly in the work of Ringrose.

We will generally let s_1, s_2, \dots, s_m be the standard generators of \mathcal{O}_m , and analogously for \mathcal{O}_∞ .

2.1.1 DEFINITION. ([47], [46]) Let A be a unital C^* -algebra. Then its (C^*) exponential length $\text{cel}(A)$ is

$$\sup_{u \in U_0(A)} \inf \left\{ \sum_{k=1}^n \|h_k\| : n \in \mathbf{N}, h_1, \dots, h_n \in A \text{ selfadjoint, } u = \exp(ih_1) \exp(ih_2) \cdots \exp(ih_n) \right\}.$$

In preparation for the following theorem, and to establish notation, we make the following remark, most of which is in [48], 3.3.

2.1.2 REMARK. Let B be a unital C^* -algebra, and let $m \geq 2$.

- (1) If $\varphi, \psi : \mathcal{O}_m \rightarrow B$ are unital homomorphisms, then the element $u = \sum_{j=1}^m \psi(s_j)\varphi(s_j)^*$ is a unitary in B such that $u\varphi(s_j) = \psi(s_j)$ for $1 \leq j \leq m$.
- (2) If $\varphi : \mathcal{O}_m \rightarrow B$ is a unital homomorphism, then the formula

$$\lambda_\varphi(a) = \sum_{j=1}^m \varphi(s_j)a\varphi(s_j)^*$$

defines a unital endomorphism λ_φ (or just λ when φ is understood) of B .

- (3) If φ and λ are as in (2), and if $u \in B$ has the form $u = v\lambda(v^*)$ for some unitary $v \in B$, then $v\varphi(s_j)v^* = u\varphi(s_j)$ for $1 \leq j \leq m$.

2.1.3 THEOREM. Let B be a unital C^* -algebra such that $\text{cel}(B)$ is finite and such that the canonical map $U(B)/U_0(B) \rightarrow K_1(B)$ is an isomorphism. Let $m \geq 2$, and let $\varphi, \psi : \mathcal{O}_m \rightarrow B$, $\lambda : B \rightarrow B$, and $u \in U(B)$ be as in Remark 2.1.2 (1) and (2). Then the following are equivalent:

- (1) $[u] \in (m-1)K_1(B)$.
- (2) For every $\varepsilon > 0$ there is $v \in U(B)$ such that $\|u - v\lambda(v^*)\| < \varepsilon$.
- (3) $[\varphi] = [\psi]$ in $KK^0(\mathcal{O}_m, B)$.
- (4) The maps φ and ψ are approximately unitarily equivalent.

Proof: For m even, this is Theorem 3.6 of [48]. In Section 3 of [48], it is also proved that (1) is equivalent to (3) and (2) is equivalent to (4) for arbitrary m , and Theorem 4.2 of [44] implies that (3) is equivalent to (4) for arbitrary m . \square

We will not actually need to use the equivalence of (3) and (4) for odd m .

That $\text{cel}(D)$ is finite for purely infinite simple C^* -algebras D was first proved in [42]. We will, however, apply this theorem to algebras D of the form $\mathcal{O}_\infty \otimes B$ with B an arbitrary unital C^* -algebra. Such algebras are shown in Lemma 2.1.7 (2) below to have finite exponential length. Actually, to prove

the classification theorem, it suffices to know that there is a universal upper bound on $\text{cel}(C(X) \otimes B)$ for B purely infinite and simple. This follows from Theorem 1.2 of [62].

We now state the fundamental results of Kirchberg on which our work depends. These were stated in [27]; proofs appear in [29].

2.1.4 THEOREM. ([27]; [29], Theorem 3.8) Let A be a separable nuclear unital simple C^* -algebra. Then $\mathcal{O}_2 \otimes A \cong \mathcal{O}_2$.

2.1.5 THEOREM. ([27]; [29], Theorem 3.15) Let A be a separable nuclear unital purely infinite simple C^* -algebra. Then $\mathcal{O}_\infty \otimes A \cong A$.

We now derive some consequences of Kirchberg's results.

2.1.6 COROLLARY. Every separable nuclear unital purely infinite simple C^* -algebra is approximately divisible in the sense of [6].

Proof: It suffices to show that \mathcal{O}_∞ is approximately divisible. Let $\varphi : \mathcal{O}_\infty \otimes \mathcal{O}_\infty \rightarrow \mathcal{O}_\infty$ be an isomorphism, as in the previous theorem. Define $\psi : \mathcal{O}_\infty \rightarrow \mathcal{O}_\infty$ by $\psi(a) = \varphi(1 \otimes a)$. Then ψ is approximately unitarily equivalent to $\text{id}_{\mathcal{O}_\infty}$ by Theorem 3.3 of [35]. That is, there are unitaries $u_n \in \mathcal{O}_\infty$ such that $u_n \varphi(1 \otimes a) u_n^* \rightarrow a$ for all $a \in \mathcal{O}_\infty$. Let $B \subset \mathcal{O}_\infty$ be a unital copy of $M_2 \oplus M_3$. Then for large enough n , the subalgebra $u_n \varphi(B \otimes 1) u_n^*$ of \mathcal{O}_∞ commutes arbitrarily well with any finite subset of \mathcal{O}_∞ . \square

2.1.7 LEMMA. Let D be any unital C^* -algebra. Then:

(1) The canonical map $U(\mathcal{O}_\infty \otimes D)/U_0(\mathcal{O}_\infty \otimes D) \rightarrow K_1(\mathcal{O}_\infty \otimes D)$ is an isomorphism.

(2) $\text{cel}(\mathcal{O}_\infty \otimes D) \leq 3\pi$.

Proof: We first prove surjectivity in (1). Let $\eta \in K_1(\mathcal{O}_\infty \otimes D)$. Choose n and $u \in U(M_n \otimes \mathcal{O}_\infty \otimes D)$ such that $[u] = \eta$. Let e_{ij} be the standard matrix units in M_n . Define (nonunital) homomorphisms

$$\varphi : \mathcal{O}_\infty \otimes D \rightarrow M_n \otimes \mathcal{O}_\infty \otimes D \quad \text{and} \quad \psi : M_n \otimes \mathcal{O}_\infty \otimes D \rightarrow \mathcal{O}_\infty \otimes D$$

by

$$\varphi(a) = e_{11} \otimes a \quad \text{and} \quad \psi(e_{ij} \otimes b) = (s_i \otimes 1)b(s_j^* \otimes 1).$$

Then φ_* is the standard stability isomorphism

$$K_1(\mathcal{O}_\infty \otimes D) \rightarrow K_1(M_n \otimes \mathcal{O}_\infty \otimes D).$$

Also, $\psi \circ \varphi(a) = (s_1 \otimes 1)a(s_1^* \otimes 1)$ for $a \in \mathcal{O}_\infty \otimes D$. Since $s_1 \otimes 1$ is an isometry, this implies that $\psi \circ \varphi$ is the identity on K-theory. Therefore $\psi_* = \varphi_*^{-1}$. Consequently

$$\eta = \varphi_*^{-1}([u]) = \psi_*([u]) = [\psi(u) + 1 - \psi(1)],$$

showing that η is the class of a unitary in $\mathcal{O}_\infty \otimes D$.

Now let $u \in U(\mathcal{O}_\infty \otimes D)$ satisfy $[u] = 0$ in $K_1(\mathcal{O}_\infty \otimes D)$. We prove that u can be connected to the identity by a path of length at most $3\pi + \varepsilon$. This will simultaneously prove (2) and injectivity in (1).

Using approximate divisibility of \mathcal{O}_∞ and approximating u by finite sums of elementary tensors, we can find nontrivial projections $e \in \mathcal{O}_\infty$ with $\|u(e \otimes 1) - (e \otimes 1)u\|$ arbitrarily small. If this norm is small enough, we can find a unitary $v \in K \otimes \mathcal{O}_\infty \otimes D$ which commutes with $e \otimes 1$ and is connected to u by a unitary path of length less than $\varepsilon/2$. Write $v = v_1 + v_2$ with

$$v_1 \in U(e\mathcal{O}_\infty e \otimes D) \quad \text{and} \quad v_2 \in U((1 - e)\mathcal{O}_\infty(1 - e) \otimes D).$$

Choose a partial isometry $s \in \mathcal{O}_\infty$ with $s^*s = 1 - e$ and $ss^* \leq e$. The proof of Corollary 5 of [42] shows that v can be connected to the unitary

$$\begin{aligned} w &= v \left[(e - ss^*) \otimes 1 + (s \otimes 1)v_2(s \otimes 1)^* + v_2^* \right] \\ &= 1 - e \otimes 1 + v_1 \left[(s \otimes 1)v_2(s \otimes 1)^* + (e - ss^*) \otimes 1 \right] \end{aligned}$$

by a path of length π .

Since \mathcal{O}_∞ is purely infinite, there is an embedding of $K \otimes e\mathcal{O}_\infty e$ in \mathcal{O}_∞ which extends the obvious identification of $e_{11} \otimes e\mathcal{O}_\infty e$ with $e\mathcal{O}_\infty e$. It extends to a unital homomorphism $\varphi : (K \otimes e\mathcal{O}_\infty e \otimes D)^+ \rightarrow \mathcal{O}_\infty \otimes D$ whose range contains w , and such that $[\varphi^{-1}(w)] = 0$ in $K_1(K \otimes e\mathcal{O}_\infty e \otimes D)$. Thus $\varphi^{-1}(w) \in U_0((K \otimes e\mathcal{O}_\infty e \otimes D)^+)$. Theorem 3.8 of [43] shows that the C^* exponential rank of any stable C^* -algebra is at most $2 + \varepsilon$. An examination of the proof, and of the length of the path used in the proof of Corollary 5 of [42], shows that in fact any stable C^* -algebra has exponential length at most 2π . Thus, in particular, $\varphi^{-1}(w)$ can be connected to 1 by a unitary path of length $2\pi + \varepsilon/2$. It follows that u can be connected to 1 by a unitary path of length at most $3\pi + \varepsilon$. □

A somewhat more complicated argument shows that in fact $\text{cel}(\mathcal{O}_\infty \otimes D) \leq 2\pi$. Details will appear elsewhere [45].

2.1.8 LEMMA. Let D be a unital C^* -algebra. Then:

- (1) Given two full projections in $K \otimes \mathcal{O}_\infty \otimes D$, each is Murray-von Neumann equivalent to a subprojection of the other.
- (2) If two full projections in $K \otimes \mathcal{O}_\infty \otimes D$ have the same K_0 -class, then they are homotopic.

Proof: Taking direct limits, we reduce to the case that D is separable. Then $\mathcal{O}_\infty \otimes D$ is approximately divisible by Corollary 2.1.6. It follows from Proposition 3.10 of [6] that two full projections in $K \otimes \mathcal{O}_\infty \otimes D$ with the same K_0 -class are Murray-von Neumann equivalent. Now (2) follows from the fact that Murray-von Neumann equivalence implies homotopy in the stabilization of a unital C^* -algebra.

Part (1) requires slightly more work. Let \mathcal{P} be the set of all projections $p \in \mathcal{O}_\infty \otimes D$ such that there are two orthogonal projections $q_1, q_2 \leq p$, both Murray-von Neumann equivalent to 1. One readily verifies that \mathcal{P} is nonempty and satisfies the conditions (Π_1) - (Π_4) on page 184 of [14]. Therefore, by [14], the group $K_0(\mathcal{O}_\infty \otimes D)$ is exactly the set of Murray-von Neumann equivalence classes of projections in \mathcal{P} . Since projections in \mathcal{P} are full, Proposition 3.10 of [6] now implies that every full projection is in \mathcal{P} . Clearly (1) holds for projections in \mathcal{P} . We obtain (1) in general by using the pure infiniteness of \mathcal{O}_∞ to show that every full projection in $K \otimes \mathcal{O}_\infty \otimes D$ is Murray-von Neumann equivalent to a (necessarily full) projection in $\mathcal{O}_\infty \otimes D$. \square

Next, we turn to exact stability. For \mathcal{O}_m , we need only the following standard result:

2.1.9 PROPOSITION. ([35], Lemma 1.3 (1)) For any integer m , the defining relations for \mathcal{O}_m , namely $s_j^* s_j = 1$ and $\sum_{k=1}^m s_k s_k^* = 1$ for $1 \leq j \leq m$, are exactly stable.

We will also need to know about the standard extension E_m of \mathcal{O}_m by the compact operators. Recall from [13] that E_m is the universal C^* -algebra on generators t_1, \dots, t_m with relations $t_j^* t_j = 1$ and $(t_j t_j^*)(t_k t_k^*) = 0$ for $1 \leq j, k \leq m$, $j \neq k$. Its properties are summarized in [35], 1.1. In particular, we have $\varinjlim E_m \cong \mathcal{O}_\infty$ using the standard inclusions.

Exact stability of the generating relations for E_m is known, but we need the following stronger result, which can be thought of as a finite version of exact stability for \mathcal{O}_∞ . Essentially, it says that if elements approximately satisfy the defining relations for E_m , then they can be perturbed in a functorial way to exactly satisfy these relations, and that the way the first k elements are perturbed does not depend on the remaining $m - k$ elements.

Recently, Blackadar has proved that in fact \mathcal{O}_∞ is semiprojective in the usual sense [5].

2.1.10 PROPOSITION. For each $\delta \geq 0$ and $m \geq 2$, let $E_m(\delta)$ be the universal unital C^* -algebra on generators $t_{j,\delta}^{(m)}$ for $1 \leq j \leq m$ and relations

$$\| (t_{j,\delta}^{(m)})^* t_{j,\delta}^{(m)} - 1 \| \leq \delta \quad \text{and} \quad \left\| \left(t_{j,\delta}^{(m)} (t_{j,\delta}^{(m)})^* \right) \left(t_{k,\delta}^{(m)} (t_{k,\delta}^{(m)})^* \right) \right\| \leq \delta$$

for $j \neq k$, and let $\kappa_\delta^{(m)} : E_m(\delta) \rightarrow E_m$ be the homomorphism given by sending $t_{j,\delta}^{(m)}$ to the corresponding standard generator $t_j^{(m)}$ of E_m . Then there are $\delta(2) \geq \delta(3) \geq \dots > 0$, nondecreasing functions $f_m : [0, \delta(m)] \rightarrow [0, \infty)$ with $\lim_{\delta \rightarrow 0} f_m(\delta) = 0$ for each m , and homomorphisms $\varphi_\delta^{(m)} : E_m \rightarrow E_m(\delta)$ for $0 \leq \delta \leq \delta(m)$, satisfying the following properties:

- (1) $\kappa_\delta^{(m)} \circ \varphi_\delta^{(m)} = \text{id}_{E_m}$.
- (2) $\| \varphi_\delta^{(m)}(t_j^{(m)}) - t_{j,\delta}^{(m)} \| \leq f_m(\delta)$.

- (3) If $0 \leq \delta \leq \delta' \leq \delta(m)$, then the composite of $\varphi_{\delta'}^{(m)}$ with the canonical map from $E_m(\delta')$ to $E_m(\delta)$ is $\varphi_{\delta}^{(m)}$.
- (4) Let $\iota_{\delta}^{(m)} : E_m(\delta) \rightarrow E_{m+1}(\delta)$ be the map given by $\iota_{\delta}^{(m)}(t_{j,\delta}^{(m)}) = t_{j,\delta}^{(m+1)}$ for $1 \leq j \leq m$. Then for $0 \leq \delta \leq \delta(m+1)$ and $1 \leq j \leq m$, we have $\iota_{\delta}^{(m)}(\varphi_{\delta}^{(m)}(t_j^{(m)})) = \varphi_{\delta}^{(m+1)}(t_j^{(m+1)})$.

Proof: The proof of exact stability of E_m , as sketched in the proof of Lemma 1.3 (2) of [35], is easily seen to yield homomorphisms satisfying the conditions demanded here. □

2.1.11 PROPOSITION. Let D be a unital purely infinite simple C^* -algebra. Then any two unital homomorphisms from \mathcal{O}_{∞} to D are homotopic. Moreover, if $\varphi, \psi : \mathcal{O}_{\infty} \rightarrow D$ are unital homomorphisms such that $\varphi(s_j) = \psi(s_j)$ for $1 \leq j \leq m$, then there is a homotopy $t \mapsto \rho_t$ such that $\rho_t(s_j) = \varphi(s_j)$ for $1 \leq j \leq m$ and all t .

Proof: We prove the second statement; the first is the special case $m = 0$.

We construct a continuous path $t \mapsto \rho_t$ of unital homomorphisms from \mathcal{O}_{∞} to D , defined for $t \in [m, \infty)$ and satisfying the following conditions:

- (1) For $k \geq m$, for $t \in [k, \infty)$, and for $1 \leq j \leq k$, we have $\rho_t(s_j) = \psi(s_j)$.
- (2) $\rho_m = \varphi$.

Given such a path, $\rho_t(s_j) \rightarrow \psi(s_j)$ for all j . Since the s_j generate \mathcal{O}_{∞} as a C^* -algebra, standard arguments show that $\rho_t(a) \rightarrow \psi(a)$ for all $a \in \mathcal{O}_{\infty}$. We have therefore constructed the required homotopy.

It remains to carry out the construction. We construct the paths $t \mapsto \rho_t$, for $t \in [m, n]$, by induction on n . The initial step is thus simply to take $\rho_m = \varphi$. For the induction step, it suffices to do the following. Assume we are given $t \mapsto \rho_t$, for $t \in [m, n]$, and satisfying $\rho_n(s_j) = \psi(s_j)$ for $1 \leq j \leq n$. We then extend $t \mapsto \rho_t$ over $t \in [n, n+1]$ so that $\rho_t(s_j) = \psi(s_j)$ for $1 \leq j \leq n$ and $t \in [n, n+1]$, and in addition $\rho_{n+1}(s_{n+1}) = \psi(s_{n+1})$.

Let $p = \sum_{j=1}^n \rho_n(s_j)\rho_n(s_j)^*$, which is a projection in D . Then define

$$e_0 = \rho_n(s_{n+1})\rho_n(s_{n+1})^* \quad \text{and} \quad e_1 = \psi(s_{n+1})\psi(s_{n+1})^*.$$

Both e_0 and e_1 are proper projections in the purely infinite simple C^* -algebra $(1-p)D(1-p)$ with K_0 -class equal to $[1_D]$, so they are homotopic. It follows that there is a unitary path $s \mapsto u_s$ in $(1-p)D(1-p)$ such that $u_0 = 1-p$ and $u_1 e_0 u_1^* = e_1$. For $s \in [0, 1/3]$, define $\rho_{n+s}(s_j) = \rho_n(s_j)$ for $1 \leq j \leq n$ and $\rho_{n+s}(s_j) = u_{3s}\rho_n(s_j)$ for $j \geq n+1$. This yields a homotopy of homomorphisms $\rho_{n+s} : \mathcal{O}_{\infty} \rightarrow D$, with ρ_n as already given, and such that the isometries $\rho_{n+1/3}(s_{n+1})$ and $\psi(s_{n+1})$ have the same range projection, namely e_1 , although they themselves are probably not equal.

By a similar argument, we extend the homotopy over $[n + 1/3, n + 2/3]$ in such a way that $\rho_{n+s}(s_j)$ is constant for $s \in [n + 1/3, n + 2/3]$ and $1 \leq j \leq n + 1$, and so that $\rho_{n+2/3}(s_{n+2})$ and $\psi(s_{n+2})$ also have the same range projection, say f .

Now e_1 and f are Murray-von Neumann equivalent, so we can identify $(e_1 + f)D(e_1 + f)$ with $M_2(e_1De_1)$. Since

$$w_1 = \begin{pmatrix} \psi(s_{n+1})\rho_{n+2/3}(s_{n+1})^* & 0 \\ 0 & [\psi(s_{n+1})\rho_{n+2/3}(s_{n+1})^*]^* \end{pmatrix} \in U_0(M_2(e_1De_1)),$$

there is a continuous path of unitaries $s \mapsto w_s$ in $M_2(e_1De_1)$, with $w_0 = 1$ and w_1 as given. For $s \in [2/3, 1]$, we now define $\rho_{n+s}(s_j) = \rho_n(s_j)$ for $j \neq n + 1, n + 2$, and $\rho_{n+s}(s_j) = w_{3s-2}\rho_{n+2/3}(s_j)$ for $j = n + 1, n + 2$. This is again a homotopy, and gives $\rho_{n+1}(s_j) = \psi(s_j)$ for $1 \leq j \leq n + 1$, as desired. The induction step is complete. \square

2.1.12 COROLLARY. Let D be any unital C^* -algebra, and let $p \in K \otimes \mathcal{O}_\infty \otimes D$ be a projection. Then $\mathcal{O}_\infty \otimes p(K \otimes \mathcal{O}_\infty \otimes D)p \cong p(K \otimes \mathcal{O}_\infty \otimes D)p$.

Proof: We may replace p by any Murray-von Neumann equivalent projection. So without loss of generality $p \leq e \otimes 1 \otimes 1$ for some projection $e \in K$. Using the pure infiniteness of \mathcal{O}_∞ , we can in fact require that e be a rank one projection. That is, we may assume $p \in \mathcal{O}_\infty \otimes D$.

By Theorem 2.1.5, there is an isomorphism $\delta : \mathcal{O}_\infty \otimes \mathcal{O}_\infty \rightarrow \mathcal{O}_\infty$. Using it, we need only consider projections $p \in \mathcal{O}_\infty \otimes \mathcal{O}_\infty \otimes D$. By the previous proposition and Theorem 2.1.5, $a \mapsto 1 \otimes \delta(a)$ is homotopic to $\text{id}_{\mathcal{O}_\infty \otimes \mathcal{O}_\infty}$. Therefore such a projection p is homotopic to $q = 1 \otimes (\delta \otimes \text{id}_D)(p)$, and hence also Murray-von Neumann equivalent to q . Now

$$q(\mathcal{O}_\infty \otimes \mathcal{O}_\infty \otimes D)q \cong \mathcal{O}_\infty \otimes [(\delta \otimes \text{id}_D)(p)][\mathcal{O}_\infty \otimes D][(\delta \otimes \text{id}_D)(p)],$$

which is unchanged by tensoring with \mathcal{O}_∞ by Theorem 2.1.5. \square

2.1.13 COROLLARY. Let D be a unital C^* -algebra. Then the hypotheses on B in Theorem 2.1.3 are satisfied for any unital corner of $K \otimes \mathcal{O}_\infty \otimes D$.

Proof: Combine the previous corollary and Lemma 2.1.7. \square

2.2 ASYMPTOTIC UNITARY EQUIVALENCE OF HOMOMORPHISMS FROM CUNTZ ALGEBRAS

In this subsection, we strengthen the main technical theorems of [48] (restated here as Theorem 2.1.3) and of [35], replacing approximate unitary equivalence by asymptotic unitary equivalence in the conclusions. We use the strong versions to obtain variants of several other known results in which we replace sequences of homomorphisms by continuous paths.

The first lemma contains the essential point in the strengthening of Theorem 2.1.3. Its proof uses the original theorem in a sort of bootstrap argument. The remaining results lead up to the strengthening of the main theorem of [35]. They are proved by modifying the proofs there.

The first two lemmas are stated together, because the proofs are very similar.

2.2.1 LEMMA. (Compare with Theorem 2.1.3.) Let D_0 be a unital C^* -algebra, and let $D = \mathcal{O}_\infty \otimes D_0$. Let $m \geq 2$, and let $t \mapsto \varphi_t$ and $t \mapsto \psi_t$, for $t \in [0, \infty)$, be two continuous paths of unital homomorphisms from \mathcal{O}_m to D . Suppose that the unitary $u_0 = \sum_{j=1}^m \psi_0(s_j)\varphi_0(s_j)^*$ satisfies $[u_0] \in (m-1)K_1(D)$. Then φ and ψ are asymptotically unitarily equivalent.

2.2.2 LEMMA. (Compare with Proposition 1.7 of [35].) Let D be a unital purely infinite simple C^* -algebra, with $[1] = 0$ in $K_0(D)$. Let $t \mapsto \varphi_t$ and $t \mapsto \psi_t$, for $t \in [0, \infty)$, be two continuous paths of unital homomorphisms from \mathcal{O}_∞ to D . Then $t \mapsto \varphi_t$ and $t \mapsto \psi_t$ are asymptotically unitarily equivalent.

We will actually only need Lemma 2.2.1 for $m = 2$.

The two lemmas are actually valid for unital asymptotic morphisms (with a suitable modification of the definition of u_0 in Lemma 2.2.2), as can be seen by applying Proposition 1.1.7. We don't need this generality, so we don't state it formally.

The proofs of the two lemmas are rather technical. We do the first (which is easier) in detail, and then describe the modifications needed for the second. Before proving them, we outline the basic idea. Given two continuous paths as in Lemma 2.2.1, we can start by applying Theorem 2.1.3 to the homomorphisms from \mathcal{O}_m to $C([0, 1]) \otimes D$ obtained by restricting the paths to $t \in [0, 1]$, with a certain error tolerance. The result is a continuous unitary path $t \mapsto v_t^{(1)}$, for $t \in [0, 1]$, such that $(v_t^{(n)})^*\psi_t(s_j)v_t^{(n)}$ is close to $\varphi_t(s_j)$. Extend $t \mapsto v_t^{(1)}$ over $[0, \infty)$ by taking it to be constant on $[1, \infty)$. Now replace $t \mapsto \psi_t$ by $t \mapsto \gamma_t^{(1)} = (v_t^{(1)})^*\psi_t(\cdot)v_t^{(1)}$. Next, we want to repeat this over $[1, 2]$, with a smaller error tolerance. Because there will be infinitely many steps, requiring in the end a product of infinitely many unitaries, there is a potential convergence problem. Thus, we insist here that the new unitary $v_t^{(1)}$ be equal to 1 for $t \in [0, 1]$. In order to arrange this, we must have homomorphisms from \mathcal{O}_m to $C([1, 2]) \otimes D$ which agree when restricted to $\{1\} \subset [1, 2]$. But $\gamma_1^{(1)}$ is only close to φ_1 . However, if $\gamma_1^{(1)}$ is close enough to φ_1 on the generators, then we can use exact stability of the relations to construct a new homomorphism $\sigma : \mathcal{O}_m \rightarrow C([1, 2]) \otimes D$ which is close to $t \mapsto \gamma_t^{(1)}$ for $t \in [1, 2]$ and does agree with φ_1 at $t = 1$. We apply Theorem 2.1.3 to this homomorphism, and proceed as before. Now repeat on $[2, 3]$, etc.

In the actual proof, it is technically convenient to reduce to the case in which $t \mapsto \varphi_t$ is constant, and to start over $\{0\}$ rather than over $[0, 1]$.

The proof of Lemma 2.2.2 is essentially the same, but it is complicated by the fact that there are infinitely many generators. We deal with only finitely many of them over each interval $[n, n + 1]$, but more and more as n increases.

Proof of Lemma 2.2.1: Corollary 2.1.13 shows that both D and $C([0, 1], D)$ satisfy the hypotheses of Theorem 2.1.3.

By transitivity of asymptotic unitary equivalence, it suffices to show that $t \mapsto \varphi_t$ and $t \mapsto \psi_t$ are both asymptotically unitarily equivalent to some constant path. Thus, without loss of generality $t \mapsto \varphi_t$ is a constant path $\varphi_t = \varphi$ for all t . Let $\lambda : D \rightarrow D$ be λ_φ as in Remark 2.1.2 (2).

Let $f : [0, \delta] \rightarrow [0, \infty)$ be a function associated with the exact stability of \mathcal{O}_m (Proposition 2.1.9) in the same way the functions f_m of Proposition 2.1.10 are associated with the exact stability of E_m .

Choose $\varepsilon'_0 > 0$ with $f(\varepsilon'_0) < 1$. Choose $\varepsilon_0 > 0$ with $\varepsilon_0 < 1/2$, and also so small that if $\omega : \mathcal{O}_m \rightarrow A$ is a unital homomorphism, and $a_1, \dots, a_m \in A$ satisfy $\|a_j - \omega(s_j)\| < \varepsilon_0$, then the a_j satisfy the relations for \mathcal{O}_m to within ε'_0 , that is,

$$\|a_j^* a_j - 1\| < \varepsilon'_0 \quad \text{and} \quad \left\| \sum_{k=1}^m a_k a_k^* - 1 \right\| < \varepsilon'_0$$

for $1 \leq j \leq m$. Set $u_0 = \sum_{j=1}^m \psi_0(s_j) \varphi(s_j)^*$; this is the same as the u_0 in the statement of the lemma, so its K_1 -class is in $(m-1)K_1(D)$. Theorem 2.1.3 therefore yields a unitary $v_0^{(0)} \in D$ such that $\|u_0 - v_0^{(0)} \lambda(v_0^{(0)})^*\| < \varepsilon_0$. Define $v_t^{(0)} = v_0^{(0)}$ for all t , and define $\gamma_t^{(0)} : \mathcal{O}_m \rightarrow D$ by $\gamma_t^{(0)}(a) = (v_t^{(0)})^* \psi_t(a) v_t^{(0)}$. Using Remark 2.1.2, we calculate:

$$\begin{aligned} \|\varphi(s_j) - \gamma_0^{(0)}(s_j)\| &= \|v_0^{(0)} \varphi(s_j) (v_0^{(0)})^* - \psi_0(s_j)\| \\ &= \|v_0^{(0)} \lambda(v_0^{(0)})^* \varphi(s_j) - u_0 \varphi(s_j)\| < \varepsilon_0 \end{aligned}$$

for $1 \leq j \leq m$.

We now construct, by induction on n , numbers $\varepsilon_n, \varepsilon'_n > 0$ and continuous paths $t \mapsto v_t^{(n)}$ of unitaries in D and $t \mapsto \gamma_t^{(n)}$ of unital homomorphisms from \mathcal{O}_m to D , for $t \in [0, \infty)$, such that $\varepsilon_0, \varepsilon'_0, v_t^{(0)}$, and $\gamma_t^{(0)}$ are as already chosen, and:

- (1) $\gamma_t^{(n)}(a) = (v_t^{(n)})^* \gamma_t^{(n-1)}(a) v_t^{(n)}$ for $a \in \mathcal{O}_m$ and $t \in [0, \infty)$.
- (2) If $n \geq 1$, then $v_t^{(n)} = 1$ for $t \leq n-1$.
- (3) If $n \geq 1$, then $\|\varphi(s_j) - \gamma_t^{(n)}(s_j)\| < 2^{-n+1}$ for $t \in [n-1, n]$, and if $n \geq 0$ then $\|\varphi(s_j) - \gamma_t^{(n)}(s_j)\| < \varepsilon_n$ for $t = n$.
- (4) $f(\varepsilon'_n) < 2^{-n}$.
- (5) Whenever $\omega : \mathcal{O}_m \rightarrow A$ is a unital homomorphism, and $a_1, \dots, a_m \in A$ satisfy $\|a_j - \omega(s_j)\| < \varepsilon_n$, then the a_j satisfy the relations for \mathcal{O}_m to within ε'_n .

(6) $\varepsilon_n < 2^{-(n+1)}$.

Suppose that $\varepsilon_n, \varepsilon'_n, v_t^{(n)}$, and $\gamma_t^{(n)}$ have been chosen. Choose ε'_{n+1} and then ε_{n+1} as in (4), (5), and (6).

For $\alpha \in [0, 1]$, define

$$a_j(\alpha) = (1 - \alpha)(\varphi(s_j) - \gamma_n^{(n)}(s_j)) + \gamma_{n+\alpha}^{(n)}(s_j).$$

Then $\|a_j(\alpha) - \gamma_{n+\alpha}^{(n)}(s_j)\| < \varepsilon_n$ for $1 \leq j \leq m$ and $\alpha \in [0, 1]$. Conditions (4) and (5), and the choice of f , provide a unital homomorphism $\sigma : \mathcal{O}_m \rightarrow C([0, 1], D)$ such that $\|\sigma(s_j) - a_j\| < 2^{-n}$ for $1 \leq j \leq m$. Define $\sigma_\alpha : \mathcal{O}_m \rightarrow D$ by $\sigma_\alpha(a) = \sigma(a)(\alpha)$ for $\alpha \in [0, 1]$ and $a \in \mathcal{O}_m$. Then

$$\|\sigma_\alpha(s_j) - \gamma_{n+\alpha}^{(n)}(s_j)\| < \varepsilon_n + 2^{-n}.$$

Functoriality of the approximating homomorphisms (the analog of (3) of Proposition 2.1.10) guarantees that $\sigma_0 = \varphi$ and $\sigma_1 = \gamma_{n+1}^{(n)}$.

Define a unitary $z \in C([0, 1], D)$ by $z_\alpha = \sum_{j=1}^m \sigma_\alpha(s_j)\varphi(s_j)^*$ for $\alpha \in [0, 1]$. Note that $z_0 = 1$, so $z \in U_0(C([0, 1], D))$. Theorem 2.1.3 provides a unitary $\alpha \mapsto y_\alpha$ in $C([0, 1], D)$ such that $\|z_\alpha - y_\alpha\lambda(y_\alpha)^*\| < \varepsilon_{n+1}/2$ for $\alpha \in [0, 1]$. Putting $\alpha = 0$, using $z_0 = 1$, and rearranging terms, we obtain $\|y_0^*\lambda(y_0) - 1\| < \varepsilon_{n+1}/2$. Now define

$$v_t^{(n+1)} = \begin{cases} 1 & t \leq n \\ y_{t-n}y_0^* & n \leq t \leq n+1 \\ y_1y_0^* & n+1 \leq t \end{cases}$$

and define $\gamma_t^{(n+1)}(a) = (v_t^{(n+1)})^*\gamma_t^{(n)}(a)v_t^{(n+1)}$.

It remains only to verify condition (3) in the induction hypothesis. For $\alpha \in [0, 1]$,

$$\begin{aligned} \|z_\alpha - v_{n+\alpha}^{(n+1)}\lambda(v_{n+\alpha}^{(n+1)})^*\| &\leq \|z_\alpha - y_\alpha\lambda(y_\alpha)^*\| + \|y_\alpha\| \|1 - y_0^*\lambda(y_0)\| \|\lambda(y_\alpha)^*\| \\ &< \varepsilon_{n+1}/2 + \varepsilon_{n+1}/2 = \varepsilon_{n+1}. \end{aligned}$$

Therefore, for $t \in [n, n+1]$, Remark 2.1.2 yields

$$\begin{aligned} \|\varphi(s_j) - \gamma_t^{(n+1)}(s_j)\| &= \|v_t^{(n+1)}\varphi(s_j)(v_t^{(n+1)})^* - \gamma_t^{(n)}(s_j)\| \\ &\leq \|v_t^{(n+1)}\lambda(v_t^{(n+1)})^*\varphi(s_j) - z_{t-n}\varphi(s_j)\| + \|\sigma_{t-n}(s_j) - \gamma_t^{(n)}(s_j)\| \\ &< \varepsilon_{n+1} + \varepsilon_n + 2^{-n} < 2^{-(n+2)} + 2^{-(n+1)} + 2^{-n} < 2^{-n+1}. \end{aligned}$$

Furthermore, if $t = n+1$, then actually $\sigma_{t-n}(s_j) = \gamma_t^{(n)}(s_j)$, and we obtain $\|\varphi(s_j) - \gamma_t^{(n+1)}(s_j)\| < \varepsilon_{n+1}$. This completes the induction.

To complete the proof, we now define $v_t = \lim_{n \rightarrow \infty} v_t^{(0)}v_t^{(1)} \dots v_t^{(n)}$ for $t \in [0, \infty)$. Note that the limit exists and defines a continuous unitary path

$t \mapsto v_t$, since $v_t^{(n+1)}, v_t^{(n+2)}, \dots$ are all equal to 1 on $[0, n)$. Furthermore, for $t \in [n, n+1]$, we have

$$\|\varphi(s_j) - v_t^* \psi_t(s_j) v_t\| = \|\varphi(s_j) - \gamma_t^{(n+1)}(s_j)\| < 2^{-n+1}.$$

This implies that φ and $t \mapsto \psi_t$ are asymptotically unitarily equivalent. \square

For the proof of Lemma 2.2.2, we need the following lemma.

2.2.3 LEMMA. Let D be a unital purely infinite simple C^* -algebra with $[1] = 0$ in $K_0(D)$. Let $m < n$, and identify E_m with the subalgebra of \mathcal{O}_n generated by s_1, \dots, s_m . Let $\varphi : E_m \rightarrow D$ be an injective unital homomorphism. Then there exists a unital homomorphism $\tilde{\varphi} : \mathcal{O}_n \rightarrow D$ such that $\tilde{\varphi}|_{E_m} = \varphi$. Moreover, if we are already given a unital homomorphism $\psi : \mathcal{O}_n \rightarrow D$, then $\tilde{\varphi}$ can be chosen to satisfy $[\tilde{\varphi}] = [\psi]$ in $KK^0(\mathcal{O}_n, D)$.

Proof: This is essentially contained in the proof of Proposition 1.7 of [35], using the equivalence of conditions (1) and (3) in Theorem 2.1.3. \square

Proof of Lemma 2.2.2: We describe how to modify the proof of Lemma 2.2.1 to obtain this result.

First, note that $U(D)/U_0(D) \rightarrow K_1(D)$ is an isomorphism because D is purely infinite simple. Furthermore, $\text{cel}(C([0, 1], D)) \leq 5\pi/2 < \infty$ by Theorem 1.2 of [62]. (It turns out that we only need this result for $D = \mathcal{O}_\infty$, so we could use Corollary 2.1.13 here instead.) Thus, the conditions on D in Lemma 2.2.1 are satisfied.

As in the proof of Lemma 2.2.1, we may assume that $t \mapsto \varphi_t$ is a constant path $\varphi_t = \varphi$ for all t .

Let the functions f_m be the ones associated with the exact stability of E_m as in Proposition 2.1.10.

The proof uses an induction argument similar to that of the proof of Lemma 2.2.1, except that at the n -th stage we work with extensions to \mathcal{O}_{2n} of $\varphi|_{E_n}$ and $\psi_t|_{E_n}$. To avoid confusion, we let s_1, s_2, \dots be the standard generators of \mathcal{O}_∞ , with the first n of them generating E_n , and we let $s_1^{(2n)}, \dots, s_{2n}^{(2n)}$ be the standard generators of \mathcal{O}_{2n} , with E_k , for $k < 2n$, being identified with the subalgebra generated by the first k of them.

We start the construction at $n = 2$ so as not to have to worry about E_0 and E_1 .

In the preliminary step, we choose $\varepsilon_2 > 0$ and $\varepsilon'_2 > 0$ so that $\varepsilon_2 < 1/8$, $f_4(\varepsilon'_2) < 1/4$, and whenever $\omega : E_2 \rightarrow A$ is a unital homomorphism, and $a_1, a_2 \in A$ satisfy $\|a_j - \omega(s_j)\| < \varepsilon_2$, then the a_j satisfy the relations for E_2 to within ε'_2 . Use Lemma 2.2.3 to choose unital homomorphisms $\tilde{\varphi}^{(2)}, \tilde{\psi}_2^{(2)} : \mathcal{O}_4 \rightarrow D$ such that $\tilde{\varphi}^{(2)}|_{E_2} = \varphi|_{E_2}$, $\tilde{\psi}_2^{(2)}|_{E_2} = \psi_2|_{E_2}$, and $[\tilde{\varphi}^{(2)}] = [\tilde{\psi}_2^{(2)}]$ in $KK^0(\mathcal{O}_4, D)$. Set

$$u = \sum_{j=1}^4 \tilde{\psi}_2^{(2)}(s_j^{(4)}) \tilde{\varphi}^{(2)}(s_j^{(4)})^*.$$

From (2) implies (3) in Theorem 2.1.3, we obtain a unitary $v_2^{(2)} \in D$ such that

$$\|u - v_2^{(2)} \lambda_{\varphi^{(2)}}(v_2^{(2)})^*\| < \varepsilon_2.$$

Define $v_t^{(2)} = v_2^{(2)}$ for $t \in [2, \infty)$, and define $\gamma_t^{(2)} : \mathcal{O}_\infty \rightarrow D$ by $\gamma_t^{(2)}(a) = (v_t^{(2)})^* \psi_t(a) v_t^{(2)}$. As in the proof of Lemma 2.2.1, a calculation shows that

$$\|\tilde{\varphi}^{(2)}(s_j^{(4)}) - (v_2^{(2)})^* \tilde{\psi}_2^{(2)}(s_j^{(4)}) v_2^{(2)}\| < \varepsilon_2$$

for $1 \leq j \leq 4$. It follows that

$$\|\varphi(s_j) - \gamma_2^{(2)}(s_j)\| < \varepsilon_2$$

for $1 \leq j \leq 2$.

In the induction step, we now require that $t \in [2, \infty)$, that $\varepsilon_2, \varepsilon'_2, \gamma_t^{(2)}$, and $v_t^{(2)}$ be as already given, that $\gamma_t^{(n)} : \mathcal{O}_\infty \rightarrow D$, and that:

- (1) $\gamma_t^{(n)}(a) = (v_t^{(n)})^* \gamma_t^{(n-1)}(a) v_t^{(n)}$ for $a \in \mathcal{O}_\infty$ and $t \in [2, \infty)$.
- (2) If $n \geq 3$, then $v_t^{(n)} = 1$ for $t \leq n$.
- (3) If $n \geq 3$, then $\|\varphi(s_j) - \gamma_t^{(n)}(s_j)\| < 2^{-n+1}$ for $t \in [n-1, n]$ and $1 \leq j \leq n-1$, and if $n \geq 2$ then $\|\varphi(s_j) - \gamma_t^{(n)}(s_j)\| < \varepsilon_n$ for $t = n$ and $1 \leq j \leq n$.
- (4) $f_n(\varepsilon'_n) < 2^{-n}$.
- (5) Whenever $\omega : E_n \rightarrow A$ is a unital homomorphism, and $a_1, \dots, a_n \in A$ satisfy $\|a_j - \omega(s_j)\| < \varepsilon_n$, then the a_j satisfy the relations for E_n to within ε'_n .
- (6) $\varepsilon_n < 2^{-(n+1)}$.

For the proof of the inductive step, we first choose ε'_{n+1} and ε_{n+1} to satisfy (4), (5), and (6). Then construct, as in the proof of Lemma 2.2.1, a continuous path of homomorphisms $\sigma_\alpha : E_n \rightarrow D$ such that $\sigma_0 = \varphi|_{E_n}$, $\sigma_1 = \gamma_{n+1}^{(n)}|_{E_n}$, and

$$\|\sigma_\alpha(s_j) - \gamma_{n+\alpha}^{(n)}(s_j)\| < \varepsilon_n + 2^{-n}$$

for $1 \leq j \leq n$.

We now claim that there is a unitary path $\alpha \mapsto w_\alpha$ in D such that $w_0 = 1$, $w_\alpha \sigma_\alpha(s_j) = \sigma_0(s_j)$ for $\alpha \in [0, 1]$ and $1 \leq j \leq n$, and $w_1 \gamma_{n+1}^{(n)}(s_{n+1}) = \varphi(s_{n+1})$. To prove this, start by defining $q_\alpha = \sum_{j=1}^n \sigma_\alpha(s_j) \sigma_\alpha(s_j)^*$. Then set $w'_\alpha = \sum_{j=1}^n \sigma_0(s_j) \sigma_\alpha(s_j)^*$, which is a partial isometry from q_α to q_0 such that $w'_\alpha \sigma_\alpha(s_j) = \sigma_0(s_j)$ for $1 \leq j \leq n$. Next, define

$$p_1 = \gamma_{n+1}^{(n)}(s_{n+1}) \gamma_{n+1}^{(n)}(s_{n+1})^* \quad \text{and} \quad p_0 = \varphi(s_{n+1}) \varphi(s_{n+1})^*.$$

Since $\gamma_{n+1}^{(n)}|_{E_n} = \sigma_1$ and $\varphi|_{E_n} = \sigma_0$, we see that p_1 and p_0 are proper subprojections of $1 - q_1$ and $1 - q_0$ respectively, both with the same class (namely $[1] = 0$) in $K_0(D)$. Standard methods therefore yield a unitary path $\alpha \mapsto c_\alpha$ in D such that $c_0 = 1$, $c_\alpha q_\alpha c_\alpha^* = q_0$, and $c_1 p_1 c_1^* = p_0$. Then $\varphi(s_{n+1})\gamma_{n+1}^{(n)}(s_{n+1})^* c_1^*$ is a unitary in $p_0 D p_0$, so there is a unitary $d \in (1 - q_0 - p_0)D(1 - q_0 - p_0)$ such that

$$\varphi(s_{n+1})\gamma_{n+1}^{(n)}(s_{n+1})^* c_1^* + d \in U_0((1 - q_0)D(1 - q_0)),$$

and a unitary path $\alpha \mapsto w''_\alpha$ in $(1 - q_0)D(1 - q_0)$ such that

$$w''_0 = 1 \quad \text{and} \quad w''_1 = \varphi(s_{n+1})\gamma_{n+1}^{(n)}(s_{n+1})^* c_1^* + d.$$

Set $w_\alpha = w'_\alpha + w''_\alpha c_\alpha$; this is the path that proves the claim.

Use Lemma 2.2.3 to choose a unital homomorphism $\tilde{\varphi}^{(n+1)} : \mathcal{O}_{2n+2} \rightarrow D$ such that $\tilde{\varphi}^{(n+1)}|_{E_{n+1}} = \varphi|_{E_{n+1}}$. Define unital homomorphisms $\tilde{\sigma}_\alpha : \mathcal{O}_{2n+2} \rightarrow D$ by

$$\tilde{\sigma}_\alpha(s_j^{(2n+2)}) = w_\alpha^* \tilde{\varphi}^{(n+1)}(s_j^{(2n+2)})$$

for $1 \leq j \leq 2n + 2$. Then

$$\tilde{\sigma}_0 = \tilde{\varphi}^{(n+1)}, \quad \tilde{\sigma}_\alpha|_{E_n} = \sigma_\alpha, \quad \text{and} \quad \tilde{\sigma}_1|_{E_{n+1}} = \gamma_{n+1}^{(n)}|_{E_{n+1}}.$$

Define z and choose y as in the proof of Lemma 2.2.1, using \mathcal{O}_{2n+2} in place of \mathcal{O}_m , $\tilde{\sigma}$ in place of σ , $\tilde{\varphi}^{(n+1)}$ in place of φ , and $\lambda = \lambda_{\tilde{\varphi}^{(n+1)}}$. Define $v_t^{(n+1)}$ and $\gamma_t^{(n+1)}$ as there. The same computations as there show that

$$\begin{aligned} & \|\varphi(s_j) - \gamma_t^{(n+1)}(s_j)\| \\ &= \|\tilde{\varphi}^{(n+1)}(s_j^{(2n+2)}) - (v_t^{(n+1)})^* \tilde{\sigma}_{t-n}(s_j^{(2n+2)}) v_t^{(n+1)}\| < 2^{-n+1} \end{aligned}$$

for $1 \leq j \leq n$ and $t \in [n, n + 1]$, and

$$\|\varphi(s_j) - \gamma_{n+1}^{(n+1)}(s_j)\| = \|\tilde{\varphi}^{(n+1)}(s_j^{(2n+2)}) - (v_t^{(n+1)})^* \tilde{\sigma}_1(s_j^{(2n+2)}) v_t^{(n+1)}\| < \varepsilon_{n+1}$$

for $1 \leq j \leq n + 1$. This completes the induction step.

Define $v_t = \lim_{n \rightarrow \infty} v_t^{(2)} v_t^{(3)} \dots v_t^{(n)}$. Calculations analogous to those in the proof of Lemma 2.2.1 show that $t \mapsto v_t$ is a continuous unitary path in D , and that for $n \geq 2$ we have

$$\|\varphi(s_j) - v_t^* \psi_t(s_j) v_t\| < 2^{-n+1}$$

for $t \in [n, n + 1]$ and $1 \leq j \leq n$. This implies that

$$\lim_{t \rightarrow \infty} \left(\varphi(a) - v_t^* \psi_t(a) v_t \right) = 0$$

for all $a \in \mathcal{O}_\infty$. □

2.2.4 LEMMA. There exists a continuous family $t \mapsto \varphi_t$ of unital endomorphisms of \mathcal{O}_∞ , for $t \in [0, \infty)$, which is asymptotically central in the sense that

$$\lim_{t \rightarrow \infty} \left(\varphi_t(b)a - a\varphi_t(b) \right) = 0$$

for all $a, b \in \mathcal{O}_\infty$.

Proof: Let A_n be the tensor product of n copies of \mathcal{O}_∞ , and define $\mu_n : A_n \rightarrow A_{n+1}$ by $\mu_n(a) = a \otimes 1$. Set $A = \varinjlim A_n$, which is just $\bigotimes_1^\infty \mathcal{O}_\infty$. Theorem 2.1.5 implies that $A_n \cong \mathcal{O}_\infty$, so Theorem 3.5 of [35] implies that $A \cong \mathcal{O}_\infty$. (Actually, that $A \cong \mathcal{O}_\infty$ is shown in the course of the proof of Theorem 2.1.5. See [29].) It therefore suffices to construct a continuous asymptotically central inclusion of \mathcal{O}_∞ in A rather than in \mathcal{O}_∞ .

Let $\nu_n : A_n \rightarrow A$ be the inclusion. Proposition 2.1.11 provides a homotopy $\alpha \mapsto \psi_\alpha$ of unital homomorphisms $\psi_\alpha : \mathcal{O}_\infty \rightarrow \mathcal{O}_\infty \otimes \mathcal{O}_\infty$ such that $\psi_0(a) = a \otimes 1$ and $\psi_1(a) = 1 \otimes a$. For $n \geq 1$ and $t \in [n, n + 1]$, we write $t = n + \alpha$ and define

$$\varphi_t(a) = \nu_{n+2}(1 \otimes 1 \otimes \cdots \otimes 1 \otimes \psi_\alpha(a)),$$

where the factor 1 appears n times in the tensor product. The two definitions of $\varphi_n(a)$ agree, so $t \mapsto \varphi_t$ is continuous. We clearly have $\lim_{t \rightarrow \infty} (\varphi_t(b)a - a\varphi_t(b)) = 0$ for $b \in \mathcal{O}_\infty$ and $a \in \bigcup_{n=1}^\infty \nu_n(A_n)$, and a standard argument then shows this is true for all $a \in A$. \square

The notation introduced in the following definition is the same as in [34], [35], and [44].

2.2.5 DEFINITION. Let A be any unital C^* -algebra, and let D be a purely infinite simple C^* -algebra. Let $\varphi, \psi : A \rightarrow D$ be two homomorphisms, and assume that $\varphi(1) \neq 0$ and $[\psi(1)] = 0$ in $K_0(D)$. We define a homomorphism $\varphi \tilde{\oplus} \psi : A \rightarrow D$, well defined up to unitary equivalence, by the following construction. Choose a projection $q \in D$ such that $0 < q < \varphi(1)$ and $[q] = 0$ in $K_0(D)$. Since D is purely infinite and simple, there are partial isometries v and w such that

$$vv^* = \varphi(1) - q, \quad v^*v = \varphi(1), \quad ww^* = q, \quad \text{and} \quad w^*w = \psi(1).$$

Now define $(\varphi \tilde{\oplus} \psi)(a) = v\varphi(a)v^* + w\psi(a)w^*$ for $a \in A$.

The proof of the following lemma could be simplified considerably by using semiprojectivity of \mathcal{O}_∞ ([5]) and Proposition 1.1.7. Since [5] remains (to our knowledge) unpublished, we retain the original proof.

2.2.6 LEMMA. (Compare with Proposition 2.3 of [35].) Let D be a unital purely infinite simple C^* -algebra, and let $q \in D$ be a projection with $[q] = 0$ in $K_0(D)$. Let $\varphi : \mathcal{O}_\infty \rightarrow D$ and $\psi : \mathcal{O}_\infty \rightarrow qDq$ be unital homomorphisms. Then φ is asymptotically unitarily equivalent to $\varphi \tilde{\oplus} \psi$.

Proof: Let $t \mapsto \gamma_t$ be a continuously parametrized asymptotically central inclusion of \mathcal{O}_∞ in \mathcal{O}_∞ , as in Lemma 2.2.4. Let $e \in \mathcal{O}_\infty$ be a nonzero projection with $[e] = 0$ in $K_0(\mathcal{O}_\infty)$, and set $e_t = \gamma_t(e)$. Choose a continuous unitary path $t \mapsto u_t$ such that $u_t e_t u_t^* = e_0$.

Let the functions $f_m : [0, \delta(m)] \rightarrow [0, \infty)$ be as in Proposition 2.1.10. Choose numbers $\varepsilon_2 > \varepsilon_3 > \cdots > 0$ and $\varepsilon'_2 > \varepsilon'_3 > \cdots > 0$ such that:

- (1) $\varepsilon'_m < \delta(m)$ and $f_m(\varepsilon'_m) < 1/m$.
- (2) Whenever $\omega : E_m \rightarrow A$ is a unital homomorphism, and $a_1, \dots, a_m \in A$ satisfy $\|a_j - \omega(s_j)\| < \varepsilon_m$, then the a_j satisfy the relations for E_m to within ε'_m .
- (3) $\varepsilon_m < 1/m$.

Next, use the asymptotic centrality of $t \mapsto e_t$ to choose $t_2 < t_3 < \cdots$, with $t_m \rightarrow \infty$ as $m \rightarrow \infty$, such that

$$\left\| s_j - \left[e_t s_j e_t + (1 - e_t) s_j (1 - e_t) \right] \right\| < \varepsilon_m$$

for $1 \leq j \leq m$ and $t \geq t_m$. Define

$$a_j(t) = u_t \left[e_t s_j e_t + (1 - e_t) s_j (1 - e_t) \right] u_t^* \in e_0 \mathcal{O}_\infty e_0 \oplus (1 - e_0) \mathcal{O}_\infty (1 - e_0).$$

Conditions (1) and (2), and Proposition 2.1.10, then yield continuous paths $t \mapsto \sigma_t^{(m)}$ of homomorphisms from E_m to $e_0 \mathcal{O}_\infty e_0 \oplus (1 - e_0) \mathcal{O}_\infty (1 - e_0)$, defined for $t \geq t_m$, such that $\|\sigma_t^{(m)}(s_j) - a_j(t)\| < 1/m$ for $1 \leq j \leq m$, and $\sigma_t^{(m+1)}|_{E_m} = \sigma_t^{(m)}$ for $t \geq t_{m+1}$.

Define

$$\alpha_t^{(m)} : E_m \rightarrow e_0 \mathcal{O}_\infty e_0 \quad \text{and} \quad \beta_t^{(m)} : E_m \rightarrow (1 - e_0) \mathcal{O}_\infty (1 - e_0)$$

by

$$\alpha_t^{(m)}(a) = e_0 \sigma_t^{(m)}(a) e_0 \quad \text{and} \quad \beta_t^{(m)}(a) = (1 - e_0) \sigma_t^{(m)}(a) (1 - e_0).$$

Note that $\alpha_{t_m}^{(m)}$ is homotopic to $\alpha_{t_{m+1}}^{(m+1)}|_{E_m}$; since $\alpha_{t_{m+1}}^{(m+1)}|_{E_m}$ is injective, it follows that $\alpha_{t_m}^{(m)}$ is injective. Since $e_0 \mathcal{O}_\infty e_0$ is purely infinite simple, it is easy to extend $\alpha_{t_m}^{(m)}$ to a homomorphism $\alpha_{t_m} : \mathcal{O}_\infty \rightarrow e_0 \mathcal{O}_\infty e_0$. Proposition 2.1.11 provides homotopies $t \mapsto \alpha_t$ of homomorphisms from \mathcal{O}_∞ to $e_0 \mathcal{O}_\infty e_0$, defined for $t \in [t_m, t_{m+1}]$, such that $\alpha_t|_{E_m} = \alpha_{t_m}^{(m)}$ and such that α_{t_m} and $\alpha_{t_{m+1}}$ are as already given. Putting these homotopies together, and defining $\alpha_t = \alpha_{t_2}$ for $t \in [0, t_2]$, we obtain a continuous path $t \mapsto \alpha_t$ of unital homomorphisms from \mathcal{O}_∞ to $e_0 \mathcal{O}_\infty e_0$, defined for $t \in [0, \infty)$, such that $\alpha_t|_{E_m} = \alpha_t^{(m)}$ whenever $t \geq t_m$. Similarly, there is a continuous path $t \mapsto \beta_t$ of unital homomorphisms

from \mathcal{O}_∞ to $(1 - e_0)\mathcal{O}_\infty(1 - e_0)$, defined for $t \in [0, \infty)$, such that $\beta_t|_{E_m} = \beta_t^{(m)}$ whenever $t \geq t_m$. Define $\sigma_t : \mathcal{O}_\infty \rightarrow \mathcal{O}_\infty$ by $\sigma_t(a) = \alpha_t(a) + \beta_t(a)$.

For $t \geq t_m$ and $1 \leq j \leq m$, we have $u_t^* \sigma_t(s_j) u_t = u_t^* \sigma_t^{(m)}(s_j) u_t$, and

$$\|u_t^* \sigma_t^{(m)}(s_j) u_t - s_j\| \leq \|\sigma_t^{(m)}(s_j) - a_j(t)\| + \|u_t^* a_j(t) u_t - s_j\| < 1/m + \varepsilon_m < 2/m.$$

Therefore $\lim_{t \rightarrow \infty} \|u_t^* \sigma_t^{(m)}(s_j) u_t - s_j\| = 0$ for all j . Thus $t \mapsto \sigma_t$ is asymptotically unitarily equivalent to $\text{id}_{\mathcal{O}_\infty}$. So φ is asymptotically unitarily equivalent to $t \mapsto \varphi \circ \sigma_t$.

Let $f < \varphi(e_0)$ be a nonzero projection with $[f] = 0$ in $K_0(D)$. Let $w_1, w_2 \in D$ be partial isometries satisfying

$$w_1^* w_1 = 1, \quad w_1 w_1^* = 1 - f, \quad \text{and} \quad w_1(1 - \varphi(e_0)) = (1 - \varphi(e_0))w_1 = 1 - \varphi(e_0)$$

and

$$w_2^* w_2 = q \quad \text{and} \quad w_2 w_2^* = f.$$

The homomorphism $\varphi \tilde{\oplus} \psi$ is only defined up to unitary equivalence, and we can take it to be

$$(\varphi \tilde{\oplus} \psi)(x) = w_1 \varphi(x) w_1^* + w_2 \psi(x) w_2^*.$$

We make the same choices when defining $(\varphi \circ \sigma_t) \tilde{\oplus} \psi$. Writing $\varphi \circ \sigma_t = \varphi \circ \alpha_t + \varphi \circ \beta_t$, with

$$\varphi \circ \alpha_t : \mathcal{O}_\infty \rightarrow \varphi(e_0) D \varphi(e_0) \quad \text{and} \quad \varphi \circ \beta_t : \mathcal{O}_\infty \rightarrow \varphi(1 - e_0) D \varphi(1 - e_0),$$

this choice gives

$$(\varphi \circ \sigma_t) \tilde{\oplus} \psi = [(\varphi \circ \alpha_t) \tilde{\oplus} \psi] + \varphi \circ \beta_t.$$

By Lemma 2.2.2, $t \mapsto (\varphi \circ \alpha_t) \tilde{\oplus} \psi$ is asymptotically unitarily equivalent to $\varphi \circ \alpha_t$. Therefore, with \sim denoting asymptotic unitary equivalence, we have

$$\varphi \tilde{\oplus} \psi \sim (\varphi \circ \alpha_t) \tilde{\oplus} \psi + \varphi \circ \beta_t \sim \varphi \circ \alpha_t + \varphi \circ \beta_t \sim \varphi.$$

This is the desired result. □

2.2.7 PROPOSITION. (Compare with Theorem 3.3 of [35].) Let D be a unital purely infinite simple C^* -algebra, and let $\varphi, \psi : \mathcal{O}_\infty \rightarrow D$ be two unital homomorphisms. Then φ is asymptotically unitarily equivalent to ψ .

Proof: Let $e = 1 - s_1 s_1^* - s_2 s_2^* \in \mathcal{O}_\infty$, and let $f = \varphi(e) \in D$. Define $\overline{\varphi} : \mathcal{O}_\infty \rightarrow f D f$ by $\overline{\varphi}(s_j) = \varphi(s_{j+2}) f$. Let $w \in M_2(D)$ be a partial isometry with $w^* w = 1 \oplus f$ and $w w^* = q \oplus 0$ for some $q \in D$. We regard $w(\varphi \oplus \overline{\varphi})(-)w^*$ and $w(\psi \oplus \overline{\varphi})(-)w^*$ as homomorphisms from \mathcal{O}_∞ to $q D q$. Furthermore, $[q] = 0$ in $K_0(D)$, so

$$\varphi \tilde{\oplus} w(\psi \oplus \overline{\varphi})(-)w^* \quad \text{and} \quad \psi \tilde{\oplus} w(\varphi \oplus \overline{\varphi})(-)w^*$$

are defined; they are easily seen to be unitarily equivalent. Using Lemma 2.2.6 for the other two steps, we therefore obtain asymptotic unitary equivalences

$$\varphi \sim \varphi \tilde{\oplus} w(\psi \oplus \overline{\varphi})(-)w^* \sim \psi \tilde{\oplus} w(\varphi \oplus \overline{\varphi})(-)w^* \sim \psi. \quad \square$$

2.2.8 COROLLARY. Let A be any unital C^* -algebra such that $\mathcal{O}_\infty \otimes A \cong A$. Then there exists an isomorphism $\beta : \mathcal{O}_\infty \otimes A \rightarrow A$ such that the homomorphism $a \mapsto \beta(1 \otimes a)$ is asymptotically unitarily equivalent to id_A .

Proof: We first prove this for $A = \mathcal{O}_\infty$. Theorem 2.1.5 implies that $\mathcal{O}_\infty \otimes \mathcal{O}_\infty \cong \mathcal{O}_\infty$; let $\beta_0 : \mathcal{O}_\infty \otimes \mathcal{O}_\infty \rightarrow \mathcal{O}_\infty$ be an isomorphism. Then $a \mapsto \beta_0(1 \otimes a)$ and $\text{id}_{\mathcal{O}_\infty}$ are two unital homomorphisms from \mathcal{O}_∞ to \mathcal{O}_∞ , so they are asymptotically unitarily equivalent by Proposition 2.2.7. Let $t \mapsto u_t$ be a unitary path such that $\lim_{t \rightarrow \infty} (\beta_0(1 \otimes a) - u_t a u_t^*) = 0$ for all $a \in \mathcal{O}_\infty$.

Now let A be as in the hypotheses. We may as well prove the result for $\mathcal{O}_\infty \otimes A$ instead of A . Take $\beta = \beta_0 \otimes \text{id}_A$; then $a \mapsto \beta(1 \otimes a)$ is asymptotically unitarily equivalent to $\text{id}_{\mathcal{O}_\infty \otimes A}$ via the unitary path $t \mapsto u_t \otimes 1$. \square

2.3 WHEN HOMOTOPY IMPLIES ASYMPTOTIC UNITARY EQUIVALENCE

In this subsection, we will prove that if A is a separable nuclear unital simple C^* -algebra and D_0 is unital, then two homotopic asymptotic morphisms from A to $K \otimes \mathcal{O}_\infty \otimes D_0$ are asymptotically unitarily equivalent. We will furthermore prove that an asymptotic morphism from A to $K \otimes \mathcal{O}_\infty \otimes D_0$ is asymptotically unitarily equivalent to a homomorphism. The method of proof of the first statement will generalize the methods of [44]. We will obtain the second via a trick.

The following two definitions will be convenient. The first is used, both here and in Section 3, to simplify terminology, and the second is the analog of Definition 2.1 of [44].

2.3.1 DEFINITION. Let A , D , and Q be C^* -algebras, with A and Q separable and with Q also unital and nuclear. Let $\varphi : A \rightarrow D$ be an asymptotic morphism. A *standard factorization* of φ through $Q \otimes A$ is an asymptotic morphism $\psi : Q \otimes A \rightarrow D$ such that $\varphi_t(a) = \psi_t(1 \otimes a)$ for all t and all $a \in A$. An *asymptotic standard factorization* of φ through $Q \otimes A$ is an asymptotic morphism $\psi : Q \otimes A \rightarrow D$ such that φ is asymptotically unitarily equivalent to the asymptotic morphism $(t, a) \mapsto \psi_t(1 \otimes a)$.

2.3.2 DEFINITION. Let A , D , and φ be as in the previous definition. An *(asymptotically) trivializing factorization* of φ is a (asymptotic) standard factorization with $Q = \mathcal{O}_2$. In this case, we say that φ is *(asymptotically) trivially factorizable*.

2.3.3 LEMMA. (Compare [44], Lemma 2.2.) Let A be separable, nuclear, unital, and simple, let D_0 be a unital C^* -algebra, and let $D = \mathcal{O}_\infty \otimes D_0$. Then any two full asymptotically trivially factorizable asymptotic morphisms from A to $K \otimes D$ are asymptotically unitarily equivalent.

Proof: It suffices to prove this for full asymptotic morphisms $\varphi, \psi : A \rightarrow K \otimes D$ with trivializing factorizations $\varphi', \psi' : \mathcal{O}_2 \otimes A \rightarrow K \otimes D$. Note that φ' and ψ' are

again full, and it suffices to prove that φ' is asymptotically unitarily equivalent to ψ' . By Theorem 2.1.4, we have $\mathcal{O}_2 \otimes A \cong \mathcal{O}_2$, and Proposition 1.1.7 then implies that φ' and ψ' are asymptotically equal to continuous families φ'' and ψ'' of homomorphisms.

We now have two continuous families of full projections $t \mapsto \varphi''_t(1)$ and $t \mapsto \psi''_t(1)$ in $K \otimes D$, parametrized by $[0, \infty)$. Standard methods show that each family is unitarily equivalent to a constant projection. Moreover, the projections $\varphi''_0(1)$ and $\psi''_0(1)$ have trivial K_0 classes, so are homotopic by Lemma 2.1.8 (2). Therefore they are unitarily equivalent. Combining the unitaries involved and conjugating by the result, we can assume $\varphi''_t(1)$ and $\psi''_t(1)$ are both equal to the constant family $t \mapsto p$ for a suitable full projection p . Now replace $K \otimes D$ by $p(K \otimes D)p$, and apply Lemma 2.2.1; its hypotheses are satisfied by Corollary 2.1.12. \square

2.3.4 COROLLARY. (Compare [44], Lemma 2.3.) Under the hypotheses of Lemma 2.3.3, the direct sum of two full asymptotically trivially factorizable asymptotic morphisms $\varphi, \psi : A \rightarrow K \otimes D$ is again full and asymptotically trivially factorizable.

Proof: Since asymptotic unitary equivalence respects direct sums, the previous lemma implies we may assume $\varphi = \psi$. We may further assume that φ actually has a trivializing factorization $\varphi' : \mathcal{O}_2 \otimes A \rightarrow K \otimes D$. Then $\varphi \oplus \psi$ has the standard factorization $\text{id}_{M_2} \otimes \varphi'$ through $(M_2 \otimes \mathcal{O}_2) \otimes A$, and this is a trivializing factorization because $M_2 \otimes \mathcal{O}_2 \cong \mathcal{O}_2$.

Fullness follows from Lemma 1.2.6 (2). \square

We also need asymptotically standard factorizations through $\mathcal{O}_\infty \otimes A$. The special properties required in the following lemma will be used in the proof of Theorem 2.3.7.

2.3.5 LEMMA. Let A be a separable unital nuclear C^* -algebra, let D_0 be unital, and let $D = \mathcal{O}_\infty \otimes D_0$. Let $\varphi : A \rightarrow K \otimes D$ be an asymptotic morphism. Then φ has an asymptotic standard factorization through $\mathcal{O}_\infty \otimes A$. In fact, φ is asymptotically unitarily equivalent to an asymptotic morphism of the form $\psi_t(a) = \delta \circ (\text{id}_{\mathcal{O}_\infty} \otimes \tilde{\varphi}_t)(1 \otimes a)$, in which $\delta : \mathcal{O}_\infty \otimes K \otimes D \rightarrow K \otimes D$ is an isomorphism, $\tilde{\varphi}$ is completely positive contractive and asymptotically equal to φ , and $\text{id}_{\mathcal{O}_\infty} \otimes \tilde{\varphi}_t$ is defined to be the tensor product of completely positive maps and is again completely positive contractive.

Proof: Lemma 1.1.5 provides a completely positive contractive asymptotic morphism $\tilde{\varphi}$ which is asymptotically equal to φ . Then $\text{id}_{\mathcal{O}_\infty} \otimes \tilde{\varphi}_t$ is the minimal tensor product of two completely positive contractive linear maps, and is therefore bounded and completely positive by Proposition IV.4.23 (i) of [58]. Looking at the proof of that proposition and of Theorem IV.3.6 of [58], we see that such a tensor product is in fact contractive. Thus, $\|\text{id}_{\mathcal{O}_\infty} \otimes \tilde{\varphi}_t\| \leq 1$ for all t . One checks that $t \mapsto (\text{id}_{\mathcal{O}_\infty} \otimes \tilde{\varphi}_t)(b)$ is continuous for b in the algebraic tensor

product of \mathcal{O}_∞ and A . It follows that continuity holds for all $b \in \mathcal{O}_\infty \otimes A$. Similarly, one checks that $t \mapsto \text{id}_{\mathcal{O}_\infty} \otimes \tilde{\varphi}_t$ is asymptotically multiplicative, so is an asymptotic morphism.

Use Corollary 2.2.8 to find an isomorphism $\delta_0 : \mathcal{O}_\infty \otimes D \rightarrow D$ such that $d \mapsto \delta_0(1 \otimes d)$ is asymptotically unitarily equivalent to id_D . This induces an isomorphism $\delta : \mathcal{O}_\infty \otimes K \otimes D \rightarrow K \otimes D$, and a unitary path $t \mapsto u_t^{(0)} \in M(K \otimes D)$ such that $\|u_t^{(0)}\delta(1 \otimes d)(u_t^{(0)})^* - d\| \rightarrow 0$ for all $d \in K \otimes D$. By Lemma 1.3.9, there is a unitary path $t \mapsto u_t \in (K \otimes D)^+$ such that $\|u_t\delta(1 \otimes d)u_t^* - d\| \rightarrow 0$ for all $d \in K \otimes D$.

We prove that the ψ that results from these choices is in fact asymptotically unitarily equivalent to $\tilde{\varphi}$; this will prove the lemma. Choose finite subsets $F_1 \subset F_2 \subset \dots$ whose union is dense in A . For each n , note that the set $S_n = \{\tilde{\varphi}_t(a) : a \in F_n, t \in [0, n]\}$ is compact in D , so that there is r_n with $\|u_t\delta(1 \otimes d)u_t^* - d\| < 2^{-n}$ for all $d \in S_n$ and $t \geq r_n$. For $\alpha \in [0, 1]$ define $f(n+\alpha) = (1-\alpha)r_n + \alpha r_{n+1}$. Then define unitaries $v_t \in (K \otimes D)^+$ by $v_t = u_{f(t)}$. For $t \in [n, n+1]$ and $a \in F_n$, this gives (using $f(t) \geq r_n$)

$$\|v_t\psi_t(a)v_t^* - \tilde{\varphi}_t(a)\| = \|u_{f(t)}\delta(1 \otimes \tilde{\varphi}_t(a))u_{f(t)}^* - \tilde{\varphi}_t(a)\| < 2^{-n}.$$

Thus ψ is in fact asymptotically unitarily equivalent to $\tilde{\varphi}$. \square

2.3.6 LEMMA. (Compare [44], Proposition 3.3.) Assume the hypotheses of Lemma 2.3.3. Let $\varphi, \psi : A \rightarrow K \otimes D$ be full asymptotic morphisms with ψ asymptotically trivially factorizable. Then $\varphi \oplus \psi$ is asymptotically unitarily equivalent to φ .

Proof: By Lemma 2.3.5, we may assume that φ has a standard factorization through $\mathcal{O}_\infty \otimes A$, say $\varphi' : \mathcal{O}_\infty \otimes A \rightarrow K \otimes D$. Using Lemma 1.3.8 on φ' and on an asymptotically trivializing factorization for ψ , we may assume without loss of generality that there are projections $p, q \in K \otimes D$ such that φ' is a unital asymptotic morphism from A to $p(K \otimes D)p$ and ψ is an asymptotically trivially factorizable unital asymptotic morphism from A to $q(K \otimes D)q$.

Choose a nonzero projection $e \in \mathcal{O}_\infty$ with trivial K_0 class. Let $t \mapsto f_t$ be a tail projection for $\varphi'(e \otimes 1)$. Choose a continuous unitary family $t \mapsto u_t$ in $p(K \otimes D)p$ such that $u_t f_t u_t^* = f_0$ for all t . Define bounded asymptotic morphisms

$$\sigma : (1 - e)\mathcal{O}_\infty(1 - e) \otimes A \rightarrow (p - f_0)(K \otimes D)(p - f_0)$$

and

$$\tau : e\mathcal{O}_\infty e \otimes A \rightarrow f_0(K \otimes D)f_0$$

by

$$\sigma_t(x) = u_t(p - f_t)\varphi'_t(x)(p - f_t)u_t^* \quad \text{and} \quad \tau_t(x) = u_t f_t \varphi'_t(x) f_t u_t^*.$$

These are in fact asymptotic morphisms, because $\lim_{t \rightarrow \infty} \|f_t - \varphi'_t(e \otimes 1)\| = 0$. Then define asymptotic morphisms

$$\tilde{\sigma} : A \rightarrow (p - f_0)(K \otimes D)(p - f_0) \quad \text{and} \quad \tilde{\tau} : A \rightarrow f_0(K \otimes D)f_0$$

by

$$\tilde{\sigma}_t(a) = \sigma_t((1 - e) \otimes a) \quad \text{and} \quad \tilde{\tau}_t(a) = \tau_t(e \otimes a).$$

It follows that

$$\lim_{t \rightarrow \infty} \|u_t \varphi'_t(1 \otimes a) u_t^* - \tilde{\sigma}_t(a) - \tilde{\tau}_t(a)\| = 0$$

for all $a \in A$, so φ is asymptotically unitarily equivalent to $\tilde{\sigma} \oplus \tilde{\tau}$. Since $[e] = 0$ in $K_0(\mathcal{O}_\infty)$, there is a unital homomorphism $\nu : \mathcal{O}_2 \rightarrow e\mathcal{O}_\infty e$, and the formula $\tilde{\tau}_t(a) = (\tau_t \circ (\nu \otimes \text{id}_A))(1 \otimes a)$ shows that $\tilde{\tau}$ has a trivializing factorization. Furthermore, $\tilde{\tau}$ is full because φ' is. So $\tilde{\tau} \oplus \psi$ is full and asymptotically trivially factorizable by Corollary 2.3.4, and therefore asymptotically unitarily equivalent to $\tilde{\tau}$ by Lemma 2.3.3. The asymptotic unitary equivalence of φ and $\tilde{\sigma} \oplus \tilde{\tau}$ now implies that $\varphi \oplus \psi$ is asymptotically unitarily equivalent to φ . \square

We now come to the main technical theorem of this section.

2.3.7 THEOREM. Let A be separable, nuclear, unital, and simple. Let D_0 be a unital C*-algebra, and let $D = \mathcal{O}_\infty \otimes D_0$. Then two full asymptotic morphisms from A to $K \otimes D$ are asymptotically unitarily equivalent if and only if they are homotopic.

This result is a continuous analog of Theorem 3.4 of [44], which gives a similar result for approximate unitary equivalence. In the proof of that theorem, to get approximate unitary equivalence to within ε on a finite set F , it was necessary to approximately absorb a large direct sum of asymptotically trivially factorizable homomorphisms—a direct sum which had to be larger for smaller ε and larger F . In the proof of the theorem stated here, we must continuously interpolate between approximate absorption of ever larger numbers of asymptotic morphisms. The resulting argument is rather messy. We try to make it easier to follow by isolating two pieces as lemmas. For the first of these, recall from Definition 1.1.4 (2) that bounded asymptotic morphisms are assumed in particular to be linear.

2.3.8 LEMMA. Let A and D be C*-algebras, with A separable. Let $\alpha \mapsto \varphi^{(\alpha)}$ be a bounded homotopy of asymptotic morphisms from A to D . Then there exists a continuous function $f : [0, \infty) \rightarrow (0, \infty)$ such that for every $a \in A$, we have

$$\lim_{t \rightarrow \infty} \left(\sup_{|\alpha_1 - \alpha_2| \leq 1/f(t)} \|\varphi_t^{(\alpha_1)}(a) - \varphi_t^{(\alpha_2)}(a)\| \right) = 0.$$

Proof: Choose finite sets $F_0 \subset F_1 \subset \dots \subset A$ whose union is dense in A .

For each n and each fixed $a \in A$, the map $(t, \alpha) \mapsto \varphi_t^{(\alpha)}(a)$ is uniformly continuous on $[0, n] \times [0, 1]$. So there is $\delta_n > 0$ such that

$$\sup\{\|\varphi_t^{(\alpha_1)}(a) - \varphi_t^{(\alpha_2)}(a)\| : t \in [0, n], |\alpha_1 - \alpha_2| \leq \delta_n, a \in F_n\} < 2^{-n}.$$

We may clearly assume $\delta_1 \geq \delta_2 \geq \dots$. Let $t \mapsto \delta(t)$ be a continuous function such that $0 < \delta(t) \leq \delta_n$ for $t \in [n-1, n]$.

We claim that if $a \in \bigcup_{n=0}^{\infty} F_n$, then

$$\lim_{t \rightarrow \infty} \left(\sup_{|\alpha_1 - \alpha_2| \leq \delta(t)} \|\varphi_t^{(\alpha_1)}(a) - \varphi_t^{(\alpha_2)}(a)\| \right) = 0.$$

To see this, let $a \in F_m$. For $n \geq m+1$, $t \in [n-1, n]$, and $|\alpha_1 - \alpha_2| \leq \delta(t)$, we have in particular $|\alpha_1 - \alpha_2| \leq \delta_n$, so that $\|\varphi_t^{(\alpha_1)}(a) - \varphi_t^{(\alpha_2)}(a)\| \leq 2^{-n}$.

The statement of the lemma, using $f(t) = 1/\delta(t)$, follows from the claim by a standard argument, since φ is bounded and $\bigcup_{n=0}^{\infty} F_n$ is dense in A . \square

2.3.9 LEMMA. Let A and Q be C^* -algebras, with Q unital and nuclear. Let $N \geq 2$, let $e_0, e_1, \dots, e_N \in Q$ be mutually orthogonal projections which sum to 1, and let $w \in Q$ be a unitary such that $we_0w^* \leq e_1$, $we_jw^* \leq e_j + e_{j+1}$ for $1 \leq j \leq N-1$, and $we_Nw^* \leq e_N + e_0$. Let $a_0, \dots, a_N, b_0, \dots, b_N \in A$. Then in $Q \otimes A$ we have

$$\begin{aligned} & \left\| (w \otimes 1) \left(\sum_{j=0}^N e_j \otimes a_j \right) (w \otimes 1)^* - \sum_{j=0}^N e_j \otimes b_j \right\| \\ & \leq \max\{\|a_N - b_0\|, \|a_0 - b_1\| + \|a_1 - b_1\|, \|a_1 - b_2\| + \|a_2 - b_2\|, \\ & \quad \dots, \|a_{N-1} - b_N\| + \|a_N - b_N\|\}. \end{aligned}$$

Proof: Let

$$x = (w \otimes 1) \left(\sum_{j=0}^N e_j \otimes a_j \right) (w \otimes 1)^* = \sum_{j=0}^N we_jw^* \otimes a_j \quad \text{and} \quad y = \sum_{j=0}^N e_j \otimes b_j.$$

Observe that if we take the indices mod $N+1$, then e_k is orthogonal to we_jw^* whenever $k \neq j, j+1$, and also if $j = k = 0$. Therefore we can calculate

$$\begin{aligned} x - y &= \left(\sum_{i=0}^N e_i \otimes 1 \right) (x - y) \left(\sum_{k=0}^N e_k \otimes 1 \right) \\ &= \sum_{j=0}^N \left[(e_j \otimes 1)(we_jw^* \otimes a_j + we_{j-1}w^* \otimes a_{j-1})(e_j \otimes 1) - e_j \otimes b_j \right] \\ & \quad + \sum_{j=0}^N \left[e_j(we_jw^*)e_{j+1} + e_{j+1}(we_jw^*)e_j \right] \otimes b_j. \end{aligned}$$

We now claim that the second term in the last expression is zero. The projections we_kw^* are orthogonal and add up to 1, and e_{j+1} is orthogonal to

all of them except for $k = j$ and $k = j + 1$. Therefore $e_{j+1} \leq we_jw^* + we_{j+1}w^*$. Also, $e_jwe_{j+1}w^* = 0$, so we obtain

$$e_j(we_jw^*)e_{j+1} = e_j(we_jw^* + we_{j+1}w^*)e_{j+1} = e_je_{j+1} = 0.$$

Similarly, $e_{j+1}(we_jw^*)e_j = 0$. So the claim is proved.

It remains to estimate the first term. Since the summands are orthogonal, the norm of this term is bounded by the maximum of the norms of the summands. Using again $e_j \leq we_{j-1}w^* + we_jw^*$, we obtain

$$\begin{aligned} & \| (e_j \otimes 1)(we_jw^* \otimes a_j + we_{j-1}w^* \otimes a_{j-1})(e_j \otimes 1) - e_j \otimes b_j \| \\ & \leq \| a_{j-1} - a_j \| + \| (e_j \otimes 1)(we_jw^* \otimes a_j + we_{j-1}w^* \otimes a_j)(e_j \otimes 1) - e_j \otimes b_j \| \\ & = \| a_{j-1} - a_j \| + \| e_j \otimes (a_j - b_j) \| \leq \| a_{j-1} - a_j \| + \| a_j - b_j \|. \end{aligned}$$

If $j = 0$, then $j - 1 = N$. We then have also $e_0we_0w^* = 0$, so $e_0 \leq we_Nw^*$, whence

$$\begin{aligned} & \| (e_0 \otimes 1)(we_0w^* \otimes a_0 + we_Nw^* \otimes a_N)(e_0 \otimes 1) - e_0 \otimes b_0 \| \\ & = \| e_0 \otimes (a_N - b_0) \| \leq \| a_N - b_0 \|. \end{aligned}$$

This proves the lemma. □

Proof of Theorem 2.3.7: That asymptotic unitary equivalence implies homotopy is Lemma 1.3.3 (1). We therefore prove the reverse implication.

Using Lemma 2.3.5, we may without loss of generality assume our homotopy has the form $\tilde{\varphi}_t^{(\alpha)}(a) = \delta(1_{\mathcal{O}_\infty} \otimes \varphi_t^{(\alpha)}(a))$, where $\delta : \mathcal{O}_\infty \otimes K \otimes D \rightarrow K \otimes D$ is a homomorphism and φ is a completely positive contractive asymptotic morphism from A to $C([0, 1], K \otimes D)$. It then suffices to prove the theorem for the homotopy of asymptotic morphisms from A to $\mathcal{O}_\infty \otimes K \otimes D$ given by $\overline{\varphi}_t^{(\alpha)}(a) = 1 \otimes \varphi_t^{(\alpha)}(a)$. (We get an asymptotic unitary equivalence of $\tilde{\varphi}^{(0)}$ and $\tilde{\varphi}^{(1)}$ by applying δ .)

The next step is to do some constructions in \mathcal{O}_∞ and \mathcal{O}_2 . Choose a projection $e \in \mathcal{O}_\infty$ with $e \neq 1$ and $[e] = [1]$ in $K_0(\mathcal{O}_\infty)$. Choose a unital homomorphism $\gamma : \mathcal{O}_2 \rightarrow (1 - e)\mathcal{O}_\infty(1 - e)$. Define isometries $\tilde{s}_j \in \mathcal{O}_\infty$ by $\tilde{s}_j = \gamma(s_j)$. Let $\lambda : \mathcal{O}_2 \rightarrow \mathcal{O}_2$ be the standard shift $\lambda(c) = s_1cs_1^* + s_2cs_2^*$. Since any two unital endomorphisms of \mathcal{O}_2 are homotopic (by Remark 2.1.2 (1) and the connectedness of the unitary group of \mathcal{O}_2), there is a homotopy $\alpha \mapsto \omega_\alpha$ of endomorphisms of \mathcal{O}_2 with $\omega_0 = \text{id}_{\mathcal{O}_2}$ and $\omega_1 = \lambda$.

We will now suppose that we are given continuous functions

$$\alpha_n : [n - 1, \infty) \rightarrow [0, 1]$$

for $n \geq 1$ such that

$$\alpha_{n+1}(n) = \alpha_n(n) \tag{1}$$

for all n , and a continuous function $F : [0, \infty) \rightarrow (0, \infty)$. (These will be chosen below.) Then we define $\psi_t : \mathcal{O}_2 \otimes A \rightarrow \mathcal{O}_\infty \otimes K \otimes D$ by

$$\begin{aligned} \psi_t(c \otimes a) &= \sum_{k=1}^n \tilde{s}_2^{k-1} \tilde{s}_1 \gamma(c) (\tilde{s}_2^{k-1} \tilde{s}_1)^* \otimes \varphi_t^{(\alpha_k \circ F(t))}(a) \\ &+ \tilde{s}_2^n \gamma(\omega_{F(t)-n}(c)) (\tilde{s}_2^n)^* \otimes \varphi_t^{(\alpha_{n+1} \circ F(t))}(a) \quad \text{for } F(t) \in [n, n+1]. \end{aligned} \tag{2}$$

(This is an orthogonal sum since the projections

$$\tilde{s}_1 \tilde{s}_1^*, \tilde{s}_2 \tilde{s}_1 (\tilde{s}_2 \tilde{s}_1)^*, \dots, \tilde{s}_2^{n-1} \tilde{s}_1 (\tilde{s}_2^{n-1} \tilde{s}_1)^*, \tilde{s}_2^n (\tilde{s}_2^n)^*$$

are mutually orthogonal.) As in the proof of Lemma 2.3.5, each ψ_t is well defined, linear, and contractive, and $t \mapsto \psi_t(b)$ is continuous for b in the algebraic tensor product of \mathcal{O}_2 and A (using (1) when $F(t) \in \mathbf{N}$), and so for all $b \in \mathcal{O}_2 \otimes A$.

We now claim that ψ , as defined by (2), is actually an asymptotic morphism from $\mathcal{O}_2 \otimes A$ to $\mathcal{O}_\infty \otimes K \otimes D$. It only remains to prove asymptotic multiplicativity. By linearity and finiteness of $\sup_t \|\psi_t\|$, it suffices to do this on elementary tensors. Since γ , ω_α , and the maps $c \mapsto \tilde{s}_2^{k-1} \tilde{s}_1 c (\tilde{s}_2^{k-1} \tilde{s}_1)^*$ and $c \mapsto \tilde{s}_2^n c (\tilde{s}_2^n)^*$ are homomorphisms (and so contractive), a calculation gives, for $F(t) \in [n, n+1]$,

$$\begin{aligned} &\lim_{t \rightarrow \infty} \|\psi_t((c_1 \otimes a_1)(c_2 \otimes a_2)) - \psi_t(c_1 \otimes a_1)\psi_t(c_2 \otimes a_2)\| \\ &\leq \lim_{t \rightarrow \infty} \|c_1 c_2\| \left(\sup_{\alpha \in [0,1]} \left\| \varphi_t^{(\alpha)}(a_1 a_2) - \varphi_t^{(\alpha)}(a_1) \varphi_t^{(\alpha)}(a_2) \right\| \right) = 0. \end{aligned}$$

Define $\iota : A \rightarrow \mathcal{O}_2 \otimes A$ by $\iota(a) = 1 \otimes a$. Then $\psi \circ \iota$ is an asymptotic morphism from A to $\mathcal{O}_\infty \otimes K \otimes D$. By definition, it has a trivializing factorization, so Lemma 2.3.6 implies that $\overline{\varphi}^{(\alpha)} \oplus (\psi \circ \iota)$ is asymptotically unitarily equivalent to $\overline{\varphi}^{(\alpha)}$. The theorem will therefore be proved if we can choose the functions F and α_n in such a way that $\overline{\varphi}^{(0)} \oplus (\psi \circ \iota)$ is asymptotically unitarily equivalent to $\overline{\varphi}^{(1)} \oplus (\psi \circ \iota)$.

Before actually choosing F and the α_n , we construct, in terms of F , the unitary path we will use for the desired asymptotic unitary equivalence. Let τ be an automorphism of $M_2(\mathcal{O}_\infty)$ which sends $1 \oplus 0$ to $e \oplus 0$ and $0 \oplus c$ to $c \oplus 0$ for all $c \in (1 - e)\mathcal{O}_\infty(1 - e)$. Let $\tilde{\tau}$ be the obvious induced automorphism of $M_2(\mathcal{O}_\infty \otimes K \otimes D)$. It suffices to prove asymptotic unitary equivalence of $\tilde{\tau} \circ (\overline{\varphi}^{(0)} \oplus (\psi \circ \iota))$ and $\tilde{\tau} \circ (\overline{\varphi}^{(1)} \oplus (\psi \circ \iota))$. Furthermore, these two asymptotic morphisms take values in $\mathcal{O}_\infty \otimes K \otimes D$, embedded as the upper left corner, so we only work there. This results in the identification

$$\tilde{\tau} \circ (\overline{\varphi}^{(\alpha)} \oplus (\psi \circ \iota)) = e \otimes \varphi^{(\alpha)}(-) + (\psi \circ \iota).$$

We further note that, by Lemma 1.3.9, it suffices to construct a continuous family of unitaries in the multiplier algebra $M(\mathcal{O}_\infty \otimes K \otimes D)$.

With these identifications and reductions, our unitary path will take the form $u_t = v(F(t)) \otimes 1$ for a suitable unitary path $r \mapsto v(r)$ in \mathcal{O}_∞ , defined for $r \in [0, \infty)$. The construction of v requires further notation.

Define projections in \mathcal{O}_∞ by $p_k = \tilde{s}_2^{k-1} \tilde{s}_1 (\tilde{s}_2^{k-1} \tilde{s}_1)^*$ and $q_n = \tilde{s}_2^n (\tilde{s}_2^n)^*$. Then

$$p_1 + p_2 + \dots + p_n + q_n + e = 1 \quad \text{and} \quad p_{n+1} + q_{n+1} = q_n.$$

Choose projections $f_k < p_k$ with $[f_k] = 1$ in $K_0(\mathcal{O}_\infty)$. Note that $f_{n+1} < q_n$. Then there are partial isometries v_k with

$$v_0^* v_0 = e, \quad v_0 v_0^* = f_1, \quad v_k^* v_k = f_k, \quad \text{and} \quad v_k v_k^* = f_{k+1},$$

and w_n with

$$w_n^* w_n = f_{n+1} \quad \text{and} \quad w_n w_n^* = e.$$

Using the connectedness of the unitary group of $(f_{n+1} + f_{n+2})\mathcal{O}_\infty(f_{n+1} + f_{n+2})$, choose a continuous path $\alpha \mapsto y_n(\alpha)$ of partial isometries from $f_{n+1} + f_{n+2}$ to $f_{n+2} + e$ such that $y_n(0) = w_n + f_{n+2}$ and $y_n(1) = v_{n+1} + w_{n+1}$. Then define

$$v(n+\alpha) = (p_1 - f_1) + \dots + (p_{n+1} - f_{n+1}) + (q_{n+1} - f_{n+2}) + v_0 + v_1 + \dots + v_n + y_n(\alpha)$$

for $n \in \mathbf{N}$ and $\alpha \in [0, 1]$. There are two definitions at each integer, but they agree, so v is a continuous path of unitaries. Furthermore, one immediately verifies that for fixed $r \in [n, n + 1]$, the unitary $w = v(r)$ and sequence of projections

$$e_0 = e, \quad e_1 = p_1, \quad e_2 = p_2, \dots, e_n = p_n, \quad e_{n+1} = q_n \tag{3}$$

satisfy the hypotheses in Lemma 2.3.9.

Now take f to be as in Lemma 2.3.8, and set $F(t) = f(t) + 2$. Define $\alpha_0 : [0, \infty) \rightarrow [0, 1]$ by $\alpha_0(r) = 0$ for all r , and choose the functions $\alpha_n : [n - 1, \infty) \rightarrow [0, 1]$ to be continuous, to satisfy (1), and such that $\alpha_{n+1}(r) = 1$ for $r \in [n, n + 1]$ and

$$|\alpha_{k+1}(r) - \alpha_k(r)| \leq 1/(n - 1) \quad \text{for } r \in [n, n + 1] \text{ and } 0 \leq k \leq n.$$

Take ψ and u to be defined using these choices of F and the α_n . Let $t \in [0, \infty)$. Set $r = F(t)$ and choose $n \in \mathbf{N}$ such that $r \in [n, n + 1]$. Let $w = v(r)$ and let e_0, \dots, e_{n+1} be as in (3). For $a \in A$, we then have

$$\begin{aligned} & \left\| u_t \left[e \otimes \varphi^{(0)}(a) + \psi_t(1 \otimes a) \right] u_t^* - \left[e \otimes \varphi^{(1)}(a) + \psi_t(1 \otimes a) \right] \right\| \\ &= \left\| (w \otimes 1) \left[\sum_{k=0}^{n+1} e_k \otimes \varphi_t^{(\alpha_k(r))}(a) \right] (w \otimes 1)^* \right. \\ & \quad \left. - \left[e_0 \otimes \varphi_t^{(1)}(a) + \sum_{k=1}^{n+1} e_k \otimes \varphi_t^{(\alpha_k(r))}(a) \right] \right\|. \end{aligned}$$

Apply Lemma 2.3.9 with $a_k = b_k = \varphi_t^{(\alpha_k(r))}(a)$ for $1 \leq k \leq n+1$, and with $a_0 = \varphi_t^{(\alpha_0(r))}(a)$ and $b_0 = \varphi_t^{(1)}(a) = \varphi_t^{(\alpha_{n+1}(r))}(a) = a_{n+1}$. It follows that the expression above is at most

$$\begin{aligned} & \max(0, \|a_0 - a_1\|, \dots, \|a_n - a_{n+1}\|) \\ &= \max\{\|\varphi_t^{(\alpha_k(r))}(a) - \varphi_t^{(\alpha_{k+1}(r))}(a)\| : 0 \leq k \leq n\} \\ &\leq \sup\{\|\varphi_t^{(\alpha_1)} - \varphi_t^{(\alpha_2)}\| : |\alpha_1 - \alpha_2| \leq 1/(n-1)\}. \end{aligned}$$

Since $n-1 \geq r-2 = f(t)$, we have $1/(n-1) \leq 1/f(t)$, and this last expression converges to 0 as $t \rightarrow \infty$. Thus we have shown that

$$e \otimes \varphi^{(0)}(-) + (\psi \circ \iota) \quad \text{and} \quad e \otimes \varphi^{(1)}(-) + (\psi \circ \iota)$$

are asymptotically unitarily equivalent. This completes the proof. \square

2.3.10 COROLLARY. Let A be separable, nuclear, unital, and simple, let D_0 be unital, and let $D = \mathcal{O}_\infty \otimes D_0$. Then any full asymptotic morphism $\varphi : A \rightarrow K \otimes D$ is asymptotically unitarily equivalent to a homomorphism.

Proof: It is obvious that an asymptotic morphism is homotopic to all of its reparametrizations. The result therefore follows from Theorem 2.3.7 and Proposition 1.3.7. \square

2.3.11 REMARK. The hypothesis of fullness can be removed in Theorem 2.3.7 (and in Corollary 2.3.10) in the following way. Let $\alpha \mapsto \varphi^{(\alpha)}$ be a homotopy of asymptotic morphisms from A to $K \otimes D$, with $D = \mathcal{O}_\infty \otimes D_0$. Applying Lemma 1.3.8, we can assume $\alpha \mapsto \varphi^{(\alpha)}$ is a homotopy of unital (hence full) asymptotic morphisms from A to $D' = p(K \otimes D)p$ for a suitable projection p . The algebra D' is stable under tensoring with \mathcal{O}_∞ by Corollary 2.1.12. So we can apply the result already proved to asymptotic morphisms from A to $K \otimes D'$. Then embed $K \otimes D'$ in $K \otimes D$.

3 UNSUSPENDED E -THEORY FOR SIMPLE NUCLEAR C^* -ALGEBRAS

In [16], Dădărlat and Loring proved that for certain C^* -algebras A , one can obtain the groups $KK^0(A, B)$ via “unsuspended E -theory”: $KK^0(A, B) \cong [[K \otimes A, K \otimes B]]$ (notation from Definition 1.1.2) for all separable B . The terminology comes from the omission of the suspension that is normally required. The conditions on A are quite restrictive, and in particular fail for trivial reasons as soon as A has even one nonzero projection.

In this section, we want to take A to be separable, nuclear, unital, and simple. To make enough room, we assume B is a tensor product $\mathcal{O}_\infty \otimes D$ with D unital. We then discard the class of the zero asymptotic morphism (the source of the difficulty with projections). We are able to prove, with the help

of Kirchberg's results as stated in Section 2.1 and also using Theorem 2.3.7, that we do in fact get $KK^0(A, B)$ as a set of suitable homotopy classes of asymptotic morphisms from $K \otimes A$ to $K \otimes B$. (Corollary 2.3.10 implies that we can even use asymptotic unitary equivalence classes of homomorphisms. See Section 4.1.)

In the first subsection, we construct for fixed A a middle exact homotopy invariant functor from separable C^* -algebras to abelian groups in a manner analogous to the definition of $K_0(D)$, but using asymptotic morphisms from A to $K \otimes \mathcal{O}_\infty \otimes D^+$ in place of projections in $K \otimes D^+$. The fact that the target algebra is infinite means that, as for K_0 of a purely infinite simple C^* -algebra, we do not need to take formal differences of classes. We do, however, need to introduce the unitization of the target algebra for essentially the same reason that it is necessary in the definition of K_0 . In the second subsection, we then show that this functor is naturally isomorphic to $KK^0(A, -)$.

3.1 THE GROUPS $[[A, K \otimes \mathcal{O}_\infty \otimes D]]_+$ AND $\tilde{E}_A(D)$

Let A be separable, nuclear, unital, and simple. In this subsection we construct a functor $[[A, K \otimes \mathcal{O}_\infty \otimes -]]_+$ on unital C^* -algebras and the corresponding functor $\tilde{E}_A(-)$ on general C^* -algebras (obtained via the unitization). We then prove that \tilde{E}_A is a cohomology theory on separable C^* -algebras in the usual sense. This information is needed in order to apply the uniqueness theorems for KK -theory in the next subsection.

3.1.1 DEFINITION. Let A be separable and unital, and assume each ideal of A is generated by its projections. Let B have an approximate identity of projections. Then $[[A, B]]_+$ denotes the set of homotopy classes of full asymptotic morphisms from A to B .

3.1.2 PROPOSITION. Let A be simple, separable, unital, and nuclear. For any unital C^* -algebra D , give $[[A, K \otimes \mathcal{O}_\infty \otimes D]]_+$ the addition operation that it receives from being a subset of $[[A, K \otimes \mathcal{O}_\infty \otimes D]]$. Then $[[A, K \otimes \mathcal{O}_\infty \otimes -]]_+$ is a functor from separable unital C^* -algebras and homotopy classes of unital asymptotic morphisms to abelian groups. The zero element is the class of any full asymptotic morphism from A to $K \otimes \mathcal{O}_\infty \otimes D$ with a standard factorization (see Definition 2.3.1) through $\mathcal{O}_2 \otimes A$.

Proof: Lemma 1.2.6 (2) shows that $[[A, K \otimes \mathcal{O}_\infty \otimes D]]_+$ is closed under the addition in $[[A, K \otimes \mathcal{O}_\infty \otimes D]]$. Therefore $[[A, K \otimes \mathcal{O}_\infty \otimes D]]_+$ is an abelian semigroup, provided it is not empty.

According to Theorem 2.3.7, homotopy is the same relation as asymptotic unitary equivalence in this set. So we can use them interchangeably.

For functoriality, let E be another unital C^* -algebra, and let $\varphi : D \rightarrow E$ be a unital asymptotic morphism. Let $\bar{\varphi} = \text{id}_{K \otimes \mathcal{O}_\infty} \otimes \varphi$ (see Proposition 1.1.8) be the induced asymptotic morphism from $K \otimes \mathcal{O}_\infty \otimes D$ to $K \otimes \mathcal{O}_\infty \otimes E$. It

is full because if $e \in K$ is any nonzero projection, then $e \otimes 1 \otimes 1$ is a full projection in $K \otimes \mathcal{O}_\infty \otimes D$ which is sent to the full projection $e \otimes 1 \otimes 1$ in $K \otimes \mathcal{O}_\infty \otimes E$. Lemmas 1.2.6 (2) and 2.1.8 (1) now imply that $\eta \mapsto [[\varphi]] \cdot \eta$ sends full asymptotic morphisms to full asymptotic morphisms.

We now construct an identity element. Theorem 2.1.4 provides an isomorphism $\nu : \mathcal{O}_2 \otimes A \rightarrow \mathcal{O}_2$. Let $\tau : \mathcal{O}_2 \rightarrow \mathcal{O}_\infty$ be an injective homomorphism (sending 1 to a nonzero projection in \mathcal{O}_∞ with trivial K_0 -class), and define a full homomorphism $\zeta : A \rightarrow \mathcal{O}_\infty$ by $\zeta(a) = (\tau \circ \nu)(1 \otimes a)$. Composing it with the full homomorphism $x \mapsto e \otimes x \otimes 1$ from \mathcal{O}_∞ to $K \otimes \mathcal{O}_\infty \otimes D$, where $e \in K$ is any nonzero projection, we obtain a full asymptotic morphism from A to $K \otimes \mathcal{O}_\infty \otimes D$ which has a standard factorization through $\mathcal{O}_2 \otimes A$.

Lemma 2.3.3 implies that any other full asymptotic morphism with a trivializing factorization is asymptotically unitarily equivalent to ζ . This class acts as the identity by Lemma 2.3.6.

Finally, we must construct additive inverses. Let $\eta \in [[A, K \otimes \mathcal{O}_\infty \otimes D]]_+$. By Lemma 2.3.5, we can take $\eta = [[\varphi]]$, where φ has a standard factorization through $\mathcal{O}_\infty \otimes A$, say $\varphi_t(a) = \psi_t(1 \otimes a)$ for some asymptotic morphism $\psi : \mathcal{O}_\infty \otimes A \rightarrow K \otimes \mathcal{O}_\infty \otimes D$. Choose a projection $f \in \mathcal{O}_\infty$ with $[f] = -1$ in $K_0(\mathcal{O}_\infty)$. Define $\bar{\psi}_t = \psi_t|_{f\mathcal{O}_\infty f \otimes A}$, and define $\bar{\varphi} : A \rightarrow K \otimes \mathcal{O}_\infty \otimes D$ by $\bar{\varphi}_t(a) = \varphi_t(f \otimes a)$. Choose a unital homomorphism

$$\nu : \mathcal{O}_2 \rightarrow \begin{pmatrix} 1 & 0 \\ 0 & f \end{pmatrix} M_2(\mathcal{O}_\infty) \begin{pmatrix} 1 & 0 \\ 0 & f \end{pmatrix}.$$

Then $(\text{id}_{M_2} \otimes \psi) \circ \nu$ provides a standard factorization of $\varphi \oplus \bar{\varphi}$ through $\mathcal{O}_2 \otimes A$. Note that $\varphi \oplus \bar{\varphi}$ is full because φ is, so it is asymptotically unitarily equivalent to ζ by Lemma 2.3.3. This shows that $[[\bar{\varphi}]]$ is the inverse of η . \square

3.1.3 DEFINITION. If D is any C^* -algebra, then we denote by $D^\#$ the C^* -algebra $K \otimes \mathcal{O}_\infty \otimes D^+$. We use the analogous notation for homomorphisms. If D is separable, we define $\tilde{E}_A(D)$ to be the kernel of the map $[[A, D^\#]]_+ \rightarrow [[A, K \otimes \mathcal{O}_\infty]]_+$ induced by the unitization map $D^+ \rightarrow \mathbf{C}$.

3.1.4 PROPOSITION. Let A be separable, nuclear, unital, and simple. Then \tilde{E}_A is a functor from separable C^* -algebras and homotopy classes of asymptotic morphisms to abelian groups.

Proof: This follows from Proposition 3.1.2 and the fact that unitizations and tensor products of asymptotic morphisms are well defined (Lemma 1.1.6 and Proposition 1.1.8). \square

3.1.5 REMARK. It is obvious that if D_1 and D_2 are unital, then there is a natural isomorphism

$$[[A, K \otimes \mathcal{O}_\infty \otimes (D_1 \oplus D_2)]]_+ \cong [[A, K \otimes \mathcal{O}_\infty \otimes D_1]]_+ \oplus [[A, K \otimes \mathcal{O}_\infty \otimes D_2]]_+.$$

It follows that for unital D , there is a natural isomorphism

$$\tilde{E}_A(D) \cong [[A, K \otimes \mathcal{O}_\infty \otimes D]]_+.$$

We will sometimes denote by φ_* the map $[[A, D_1]]_+ \rightarrow [[A, D_2]]_+$ or the map $\tilde{E}_A(D_1) \rightarrow \tilde{E}_A(D_2)$ induced by a (full) homomorphism $\varphi : D_1 \rightarrow D_2$.

3.1.6 LEMMA. Let A be separable, nuclear, unital, and simple. Let

$$0 \longrightarrow J \xrightarrow{\mu} D \xrightarrow{\pi} D/J \longrightarrow 0$$

be a short exact sequence of separable C*-algebras. Then the sequence

$$\tilde{E}_A(J) \xrightarrow{\mu_*} \tilde{E}_A(D) \xrightarrow{\pi_*} \tilde{E}_A(D/J)$$

is exact in the middle.

Proof: It is immediate that $\pi_* \circ \mu_* = 0$.

For the other half, we introduce the maps $\chi_D : D^\# \rightarrow K \otimes \mathcal{O}_\infty$ and $\iota_D : K \otimes \mathcal{O}_\infty \rightarrow D^\#$ associated with the unitization maps $D^+ \rightarrow \mathbf{C}$ and $\mathbf{C} \rightarrow D^+$. Define $\chi_{D/J}, \iota_{D/J}$, etc. similarly. Now let $\eta \in \ker(\pi_*)$, and choose a full asymptotic morphism $\varphi : A \rightarrow D^\#$ whose class is η . By definition, we have $[[\pi^\# \circ \varphi]] = 0$ in $[[A, (D/J)^\#]]_+$. Choose a full homomorphism $\zeta : A \rightarrow K \otimes \mathcal{O}_\infty$ with a standard factorization through $\mathcal{O}_2 \otimes A$, as in the proof of Proposition 3.1.2. Theorem 2.3.7 then implies that $\pi^\# \circ \varphi$ is asymptotically unitarily equivalent to $\iota_{D/J} \circ \zeta$, so there is a unitary path $t \rightarrow u_t$ in $((D/J)^\#)^+$ such that $u_t(\pi^\# \circ \varphi_t)(a)u_t^* \rightarrow (\iota_{D/J} \circ \zeta)(a)$ for all $a \in A$.

Without changing homotopy classes, we may replace φ by $\varphi \oplus 0$ and ζ by $\zeta \oplus 0$. This also replaces $\pi^\# \circ \varphi$ and $\iota_{D/J} \circ \zeta$ by their direct sums with the zero asymptotic morphism. We then replace u_t by $u_t \oplus u_t^*$. We may thus assume without loss of generality that u is in the identity component of the unitary group of $C_b([0, \infty), ((D/J)^\#)^+)$. Therefore there is $v \in U_0(C_b([0, \infty), (D^\#)^+))$ whose image is u . Then $\pi^\#(v_t) = u_t$ for all t , whence

$$\lim_{t \rightarrow 0} \pi^\#(v_t \varphi_t(a) v_t^* - (\iota_D \circ \zeta)(a)) = 0$$

for all $a \in A$.

Let $\sigma : (D/J)^\# \rightarrow D^\#$ be a continuous (nonlinear) cross section for $\pi^\#$ satisfying $\sigma(0) = 0$. (See [1].) Define $\psi_t : A \rightarrow D^\#$ by

$$\psi_t(a) = v_t \varphi_t(a) v_t^* - (\sigma \circ \pi^\#) \left(v_t \varphi_t(a) v_t^* - (\iota_D \circ \zeta)(a) \right).$$

This yields an asymptotic morphism asymptotically equal to $t \mapsto v_t \varphi_t(-) v_t^*$, and hence asymptotically unitarily equivalent to φ . Furthermore, $\pi^\#(\psi_t(a) - (\iota_D \circ \zeta)(a)) = 0$ for all t and a . It follows that $\psi_t(a) \in J^\#$ and that $\chi_J(\psi_t(a)) = \zeta(a)$. So ψ is in fact a full asymptotic morphism from A to $J^\#$ such that $[[\chi_J \circ \psi]] = 0$, from which it follows that ψ defines a class $[[\psi]] \in \tilde{E}_A(J)$. Clearly $\mu_*([[\psi]]) = \eta$. This shows that $\ker(\pi_*) \subset \text{Im}(\mu_*)$. \square

3.1.7 COROLLARY. Let A be separable, nuclear, unital, and simple. Let

$$0 \longrightarrow J \xrightarrow{\mu} D \xrightarrow{\pi} D/J \longrightarrow 0$$

be a split short exact sequence of separable C^* -algebras. Then there is a natural split exact sequence

$$0 \longrightarrow \tilde{E}_A(J) \xrightarrow{\mu_*} \tilde{E}_A(D) \xrightarrow{\pi_*} \tilde{E}_A(D/J) \longrightarrow 0.$$

Proof: This is Proposition 4.1 (b) of [15], noting that the proof of Part (b) there doesn't use stability. Indeed, since \tilde{E}_A is middle exact (the previous lemma) and homotopy invariant, Lemma 5 in Section 7 of [26] provides a long exact sequence

$$\dots \xrightarrow{(S\mu)_*} \tilde{E}_A(SD) \xrightarrow{(S\pi)_*} \tilde{E}_A(S(D/J)) \longrightarrow \tilde{E}_A(J) \xrightarrow{\mu_*} \tilde{E}_A(D) \xrightarrow{\pi_*} \tilde{E}_A(D/J).$$

The desired conclusion can now be immediately obtained using the splitting map. \square

3.1.8 REMARK. It should be pointed out that we need much less than the full strength of Theorem 2.3.7 here. Only knowing that homotopy implies asymptotic unitary equivalence for full asymptotic morphisms from A to $K \otimes \mathcal{O}_\infty \otimes C([0, 1])$, it is possible to prove middle exactness in the first stage of the Puppe sequence, namely

$$\tilde{E}_A(C\pi) \longrightarrow \tilde{E}_A(D) \longrightarrow \tilde{E}_A(D/J).$$

This sequence can be extended to the left as in the proof of Proposition 2.6 of [56]. Proposition 3.2 of [16] can then be used to show that \tilde{E}_A is split exact.

We now prove stability of \tilde{E}_A under formation of tensor products with both K and \mathcal{O}_∞ .

3.1.9 LEMMA. Let A be separable, nuclear, unital, and simple, and let D be a separable C^* -algebra. Then the map $d \mapsto 1 \otimes d$, from D to $\mathcal{O}_\infty \otimes D$, induces an isomorphism $\tilde{E}_A(D) \rightarrow \tilde{E}_A(\mathcal{O}_\infty \otimes D)$.

Proof: By naturality, Proposition 3.1.7, and the Five Lemma, it suffices to prove this for unital D . By Remark 3.1.5, we have to prove that $d \mapsto 1 \otimes d$ induces an isomorphism $[[A, K \otimes \mathcal{O}_\infty \otimes D]]_+ \rightarrow [[A, K \otimes \mathcal{O}_\infty \otimes \mathcal{O}_\infty \otimes D]]_+$. This follows from Theorem 2.1.5 and Proposition 2.1.11, since these results imply that the map $x \mapsto x \otimes 1$, from \mathcal{O}_∞ to $\mathcal{O}_\infty \otimes \mathcal{O}_\infty$, is homotopic to an isomorphism. \square

The other stability result requires the following lemma. We really want an increasing continuously parametrized approximate identity of projections, but of course such a thing does not exist. The quasiincreasing version in the lemma is good enough.

3.1.10 LEMMA. Let D be a unital purely infinite simple C^* -algebra, and let $e_0 \in K \otimes D$ be a nonzero projection. Then there exists a continuous family

$t \mapsto e_t$ of projections in $K \otimes D$ such that, for every $b \in K \otimes D$, we have

$$\lim_{t \rightarrow \infty} (e_t b - b) = \lim_{t \rightarrow \infty} (b e_t - b) = \lim_{t \rightarrow \infty} (e_t b e_t - b) = 0,$$

such that e_0 is the given projection, and such that $e_s \geq e_t$ for $s \geq t + 1$.

Proof: Choose a nonzero projection $p \in K \otimes D$ such that $[p] = 0$ in $K_0(D)$. We start by constructing a family $t \mapsto f_t$ in $K \otimes pDp$. Note that

$$[\text{diag}(1_{pDp}, 0, 0)] = [\text{diag}(1_{pDp}, 1_{pDp}, 0)] = 0$$

in $K_0(M_3(pDp))$. Therefore there is a homotopy $t \mapsto q_t$ of projections in $M_3(pDp)$ such that

$$q_0 = \text{diag}(1, 0, 0) \quad \text{and} \quad q_1 = \text{diag}(1, 1, 0).$$

Now define

$$f_{n+s} = 1_{M_{n+1}(pDp)} \oplus q_s \oplus 0 \in K \otimes pDp$$

for $n = 0, 1, \dots$ and $s \in [0, 1]$. The family f_t is clearly continuous. It satisfies $f_0 = p \oplus p$. We have $f_t \geq 1_{M_{n+1}(pDp)}$ for $t \geq n$, so $t \mapsto f_t$ really is an approximate identity. Finally, $f_t \leq 1_{M_{n+3}(pDp)}$ for $t \leq n$, so $f_s \geq f_t$ for $s \geq t + 4$. We can replace 4 by 1 in this last statement by a reparametrization.

To get the general case, choose a projection $r \in pDp$ with $[r] = -[e_0]$ in $K_0(D)$. Then $f_t \geq p \geq r$ for all t , so $t \mapsto f_t - r$ is a continuously parametrized approximate identity of projections for $(1 - r)(K \otimes pDp)(1 - r)$. (Here 1 is the identity of $(K \otimes pDp)^+$.) There is an isomorphism

$$\varphi : K \otimes D \rightarrow (1 - r)(K \otimes pDp)(1 - r),$$

and since $[f_0 - r] = [e_0]$ in $K_0(D)$, we can require that $\varphi(e_0) = f_0 - r$. Now set $e_t = \varphi^{-1}(f_t - r)$. Then clearly $e_t b - b, b e_t - b \rightarrow 0$ as $t \rightarrow \infty$. It follows that

$$\|e_t b e_t - b\| \leq \|e_t b - b\| \|e_t\| + \|b e_t - b\| \rightarrow 0$$

as well. □

3.1.11 LEMMA. Let A be separable, nuclear, unital, and simple, let D be separable, and let $e \in K$ be a rank one projection. Then the map $d \mapsto e \otimes d$, from D to $K \otimes D$, induces an isomorphism $\tilde{E}_A(D) \rightarrow \tilde{E}_A(K \otimes D)$.

Proof: By Lemma 3.1.9, we may use $\mathcal{O}_\infty \otimes D$ in place of D , and as in its proof we may assume D is unital.

Let $s \in \mathcal{O}_\infty$ be a proper isometry, and define $\gamma : \mathcal{O}_\infty \otimes D \rightarrow \mathcal{O}_\infty \otimes D$ by $\gamma(a) = (s \otimes 1)a(s \otimes 1)^*$. We claim that $\gamma_* : \tilde{E}_A(\mathcal{O}_\infty \otimes D) \rightarrow \tilde{E}_A(\mathcal{O}_\infty \otimes D)$ is an isomorphism. It follows from Remark 3.1.5 and Definition 3.1.3 that this map can be thought of as composition with $\text{id}_{K \otimes \mathcal{O}_\infty} \otimes \gamma$ from $[[A, K \otimes \mathcal{O}_\infty \otimes \mathcal{O}_\infty \otimes D]]_+$ to itself, even though γ is not unital. (The discrepancy is an orthogonal sum with an asymptotic morphism which up to homotopy

has a trivializing factorization. Note that the composition with γ is still full.) Now $K \otimes ss^* \mathcal{O}_\infty ss^*$ and $K \otimes (1 - ss^*) \mathcal{O}_\infty (1 - ss^*)$ are both isomorphic to $K \otimes \mathcal{O}_\infty$, so we may as well consider the map from $[[A, K \otimes \mathcal{O}_\infty \otimes \mathcal{O}_\infty \otimes D]]_+$ to $[[A, M_2(K \otimes \mathcal{O}_\infty \otimes \mathcal{O}_\infty \otimes D)]]_+$ induced by inclusion in the upper right corner. Let $\tau : M_2(K) \rightarrow K$ be an isomorphism. Then $a \mapsto \tau(a \oplus 0)$ is homotopic to id_K and $b \mapsto \tau(b) \oplus 0$ is homotopic to $\text{id}_{M_2(K)}$. So our map has an inverse given by composition with $\tau \otimes \text{id}_{\mathcal{O}_\infty \otimes \mathcal{O}_\infty \otimes D}$.

We next require a construction involving \mathcal{O}_∞ and $K \otimes \mathcal{O}_\infty$. Define $\varphi : \mathcal{O}_\infty \rightarrow K \otimes \mathcal{O}_\infty$ by $\varphi(x) = e \otimes x$. Let $t \mapsto e_t$ be a continuously parametrized approximate identity for $K \otimes \mathcal{O}_\infty$ which satisfies the properties of the previous lemma and has $e_0 = e \otimes 1$. Let $t \mapsto u_t$ be a continuous family of unitaries in $(K \otimes \mathcal{O}_\infty)^+$ such that $u_0 = 1$ and $u_t e_t u_t^* = e_0$ for all t . Define $\psi_t^{(0)} : K \otimes \mathcal{O}_\infty \rightarrow K \otimes \mathcal{O}_\infty$ by $\psi_t^{(0)}(a) = u_t e_t a e_t u_t^*$. One immediately checks that $\psi^{(0)}$ is an asymptotic morphism whose values are in $(e \otimes 1)(K \otimes \mathcal{O}_\infty)(e \otimes 1)$, so that there is an asymptotic morphism $t \mapsto \psi_t$ from $K \otimes \mathcal{O}_\infty$ to \mathcal{O}_∞ such that $\varphi \circ \psi_t = \psi_t^{(0)}$ for all t .

The composite asymptotic morphisms $\varphi \circ \psi$ and $\psi \circ \varphi$ can be computed without reparametrization, because φ is a homomorphism. Now $\varphi \circ \psi = \psi^{(0)}$, which is asymptotically unitarily equivalent to $(t, a) \mapsto e_t a e_t$, which in turn is asymptotically equal to $\text{id}_{K \otimes \mathcal{O}_\infty}$. So $\varphi \circ \psi$ is homotopic to $\text{id}_{K \otimes \mathcal{O}_\infty}$. Also, $\psi \circ \varphi$ is clearly homotopic to a map of the form $x \mapsto s x s^*$ for a proper isometry $s \in \mathcal{O}_\infty$.

We now observe that $\text{id}_{K \otimes \mathcal{O}_\infty} \otimes (\varphi \otimes \text{id}_D)^+$ and $\text{id}_{K \otimes \mathcal{O}_\infty} \otimes (\psi \otimes \text{id}_D)^+$ define full asymptotic morphisms from $(\mathcal{O}_\infty \otimes D)^\#$ to $(K \otimes \mathcal{O}_\infty \otimes D)^\#$ and back. The composite from $(K \otimes \mathcal{O}_\infty \otimes D)^\#$ to itself is homotopic to the identity, and therefore induces the identity map on $\tilde{E}_A(K \otimes \mathcal{O}_\infty \otimes D)$. Composition on the right with the composite from $(\mathcal{O}_\infty \otimes D)^\#$ to itself is a map of the form γ_* as considered at the beginning of the proof, and is thus an isomorphism from $\tilde{E}_A(\mathcal{O}_\infty \otimes D)$ to itself. It follows that φ_* is an isomorphism. \square

3.2 THE ISOMORPHISM WITH KK -THEORY

In this subsection, we prove that if A is separable, nuclear, unital, and simple, and D is separable, then the natural map from $\tilde{E}_A(D)$ to $KK^0(A, D)$ is an isomorphism. Combined with Remark 3.1.5, this gives for unital D a form of “unsuspended E -theory” as in [16], in which we need only discard the zero asymptotic morphism.

We will use the universal property of KK -theory with respect to split exact, stable, and homotopy invariant functors on separable C^* -algebras [24]. (We use this instead of the related property of E -theory because it is more convenient for the proof of Lemma 3.2.3 below.)

3.2.1 NOTATION. In this subsection, we denote by \mathcal{S} the category of separable C^* -algebras and homomorphisms and by \mathcal{KK} the category of sepa-

rable C^* -algebras with morphisms $KK^0(A, B)$ for C^* -algebras A and B . If $\eta \in KK^0(A, B)$ and $\lambda \in KK^0(B, C)$, we denote their product by $\lambda \times \eta \in KK^0(A, C)$. We further denote by k the functor from \mathcal{S} to \mathcal{KK} which sends a homomorphism to the class it defines in KK -theory.

3.2.2 LEMMA. Let A be separable, nuclear, unital, and simple. Then there is a functor \widehat{E}_A from \mathcal{KK} to the category of abelian groups such that $\widehat{E}_A \circ k = \widetilde{E}_A$.

This simply means that one can make sense of $\widetilde{E}_A(\eta) : \widetilde{E}_A(D) \rightarrow \widetilde{E}_A(F)$ not only when η is an asymptotic morphism from D to F , but also when η is merely an element of $KK^0(D, F)$.

Proof of Lemma 3.2.2: The result is immediate from Theorem 4.5 of [24], since \widetilde{E}_A is a stable (Lemma 3.1.11), split exact (Corollary 3.1.7), and homotopy invariant (Proposition 3.1.4) functor from separable C^* -algebras to abelian groups. \square

We want to show that $\widetilde{E}_A(D)$ is naturally isomorphic to $KK^0(A, D)$. Our argument is based on an alternate proof of the main theorem of [16] suggested by the referee of that paper; we are grateful to Marius Dădărlat for telling us about it. The argument requires the construction of certain natural transformations. (The argument used in Section 4 of [16] presumably also works.)

Before starting the construction, we prove a lemma on the functors \widehat{F} of Higson [24] (as used in the previous lemma).

3.2.3 LEMMA. Let F and G be stable, split exact, and homotopy invariant functors from \mathcal{S} to the category of abelian groups, and let \widehat{F} and \widehat{G} be the unique extensions to functors from \mathcal{KK} of Theorem 4.5 of [24]. (In particular, F or G could be \widetilde{E}_A and \widehat{F} or \widehat{G} could be \widehat{E}_A , as in Lemma 3.2.2.) If α is a natural transformation from F to G , then α is also a natural transformation from \widehat{F} to \widehat{G} .

Proof: Let $\mu \in KK^0(A, B)$. By Lemma 3.6 of [24], we can choose a representative cycle (in the sense of Definition 2.1 of [24]) of the form $\Phi = (\varphi_+, \varphi_-, 1)$, where $\varphi_+, \varphi_- : A \rightarrow M(K \otimes B)$ are homomorphisms such that $\varphi_+(a) - \varphi_-(a) \in K \otimes B$ for $a \in A$. The homomorphism $\widehat{F}(\mu)$ is then the composite

$$F(A) \xrightarrow{F(\widehat{\varphi}_+) - F(\widehat{\varphi}_-)} F(A_\Phi) \xrightarrow{F(\pi)} F(K \otimes B) \xrightarrow{F(\varepsilon)^{-1}} F(B),$$

for a certain C^* -algebra A_Φ , certain homomorphisms $\pi, \widehat{\varphi}_+$, and $\widehat{\varphi}_-$, and with $\varepsilon(a) = 1 \otimes a$. (See Definition 3.4 and the proofs of Theorems 3.7 and 4.5 in [24].) From this expression, it is obvious that naturality with respect to homomorphisms implies naturality with respect to classes in KK -theory. \square

3.2.4 DEFINITION. Let A be separable, nuclear, unital, and simple. We regard $KK^0(A, -)$ and \widehat{E}_A as functors from \mathcal{KK} to abelian groups. (On morphisms,

the first of these sends $\eta \in KK^0(D_1, D_2)$ to Kasparov product with η .) We now define natural transformations

$$\alpha : KK^0(A, -) \rightarrow \widehat{E}_A \quad \text{and} \quad \beta : \widehat{E}_A \rightarrow KK^0(A, -).$$

To define α_D , let $e \in K$ be a rank one projection, let $\iota_A : A \rightarrow K \otimes \mathcal{O}_\infty \otimes A$ be the map $\iota_A(a) = e \otimes 1 \otimes a$, and let $[[\iota_A]] \in \widehat{E}_A(A)$ denote its class in $[[A, K \otimes \mathcal{O}_\infty \otimes A]]_+ \cong \widetilde{E}_A(A)$. (Recall that A is unital, so that Remark 3.1.5 applies.) Now let $\eta \in KK^0(A, D)$. Then $\widehat{E}_A(\eta)$ is a homomorphism from $\widetilde{E}_A(A)$ to $\widetilde{E}_A(D)$. Define

$$\alpha_D(\eta) = \widehat{E}_A(\eta)([[\iota_A]]) \in \widetilde{E}_A(D).$$

To define β_D , let $\chi_D : D^\# \rightarrow K \otimes \mathcal{O}_\infty$ be the standard map (as in the proof of Lemma 3.1.6). Starting with $\eta \in \widetilde{E}_A(D) \subset [[A, D^\#]]$, choose a full asymptotic morphism $\varphi : A \rightarrow D^\#$ with $[[\chi_D]] \cdot [[\varphi]] = 0$ which represents η . Now recall (Corollary 9 (b) of [11]; Section 5 of [54]) that for A and B separable and A (K-)nuclear, there is a canonical isomorphism $E(A, B) \cong KK^0(A, B)$. Further recall that there is a canonical isomorphism $KK^0(SA, SB) \cong KK^0(A, B)$ (Theorem 7 of Section 5 of [26]). Form the second suspension

$$\begin{aligned} [[S^2\varphi]] \in [[S^2A, S^2D^\#]] &= E(SA, SD^\#) \\ &\cong KK^0(SA, SD^\#) \cong KK^0(A, \mathcal{O}_\infty \otimes D^+), \end{aligned}$$

and regard $[[S^2\varphi]]$ as an element of $KK^0(A, \mathcal{O}_\infty \otimes D^+)$. Since $[[S^2\chi_D]] \cdot [[S^2\varphi]] = 0$, split exactness of $KK^0(A, -)$ implies that $[[S^2\varphi]]$ is actually in $KK^0(A, \mathcal{O}_\infty \otimes D)$. In this last expression, we can use the KK -equivalence of \mathcal{O}_∞ and \mathbf{C} , given by the unital homomorphism $\mathbf{C} \rightarrow \mathcal{O}_\infty$, to drop \mathcal{O}_∞ . We thus obtain an element $\beta_D(\eta) \in KK^0(A, D)$.

3.2.5 LEMMA. The maps α_D and β_D of the previous definition are in fact natural transformations.

Proof: It is easy to check that both α and β are natural with respect to homomorphisms, so naturality with respect to classes in KK -theory follows from Lemma 3.2.3. \square

3.2.6 THEOREM. Let A be separable, nuclear, unital, and simple. Then for every separable D , the maps α_D and β_D of Definition 3.2.4 are mutually inverse isomorphisms.

Proof: It is convenient to prove this first under the assumptions that $\mathcal{O}_\infty \otimes A \cong A$ and $\mathcal{O}_\infty \otimes D \cong D$. It then follows that the map $a \mapsto 1 \otimes a$ from A to $\mathcal{O}_\infty \otimes A$ is homotopic to an isomorphism, and similarly for D . (This is true for \mathcal{O}_∞ by Theorem 2.1.5 and Proposition 2.1.11. Therefore it is true for $\mathcal{O}_\infty \otimes A$ and $\mathcal{O}_\infty \otimes D$, hence for A and D .) Thus, A and $\mathcal{O}_\infty \otimes A$ are naturally homotopy equivalent, and therefore also naturally equivalent in \mathcal{KK} as well.

Similar considerations apply to D . Thus, $\tilde{E}_A(D)$ becomes just $[[A, K \otimes D]]_+$. The natural transformations above are then given by

$$\alpha_D(\eta) = \widehat{E}_A(\eta)([[\text{id}_A]])$$

(with id_A being the obvious map from A to $K \otimes A$), and

$$\beta_D([[\varphi]]) = [[S^2 \varphi]] \in [[S^2 A, K \otimes S^2 D]] \cong KK^0(A, D).$$

Letting 1_A denote the class in $KK^0(A, A)$ of the identity map, we then immediately verify that

$$\alpha_A(1_A) = [[\text{id}_A]] \quad \text{and} \quad \beta_A([[\text{id}_A]]) = 1_A.$$

We now show that these two facts imply the theorem for unital D . Let $\eta \in KK^0(A, D)$. Then $\eta = 1_A \times \eta$, and naturality implies that

$$\beta_D(\alpha_D(1_A \times \eta)) = \beta_D(\widehat{E}_A(\eta)(\alpha_A(1_A))) = \beta_A(\alpha_A(1_A)) \times \eta = 1_A \times \eta.$$

So $\beta_D \circ \alpha_D = \text{id}$. For the other direction, let $\mu \in \widehat{E}_A(D)$. Using Corollary 2.3.10, represent μ as the class of a full homomorphism $\varphi : A \rightarrow K \otimes D$. Let $\eta = [[S^2 \varphi]]$ be the KK -class determined by $[[\varphi]]$. Then, identifying $K \otimes K$ with K as necessary, we have

$$\mu = \varphi_*([[\text{id}_A]]) = \widehat{E}_A(\eta)([[\text{id}_A]]).$$

The same argument as above now shows that

$$(\alpha_D \circ \beta_D) \left(\widehat{E}_A(\eta)([[\text{id}_A]]) \right) = \widehat{E}_A(\eta)([[\text{id}_A]]).$$

So $\alpha_D \circ \beta_D = \text{id}$ also.

The result for nonunital algebras follows from naturality, split exactness, and the Five Lemma.

To remove the assumption that $\mathcal{O}_\infty \otimes D \cong D$, use Lemma 3.1.9.

Finally, we remove the assumption that $\mathcal{O}_\infty \otimes A \cong A$. Let $\delta_0 : \mathcal{O}_\infty \otimes \mathcal{O}_\infty \rightarrow \mathcal{O}_\infty$ be an isomorphism (from Theorem 2.1.5), and let $\delta : \mathcal{O}_\infty \otimes K \otimes \mathcal{O}_\infty \rightarrow K \otimes \mathcal{O}_\infty$ be the obvious corresponding map. Define $i_D : \tilde{E}_A(D) \rightarrow \tilde{E}_{\mathcal{O}_\infty \otimes A}(D)$ by

$$i_D([[\eta]]) = [[\delta \otimes \text{id}_{D^+}]] \cdot [[\text{id}_{\mathcal{O}_\infty} \otimes \eta]].$$

Let $j_D : KK^0(A, D) \rightarrow KK^0(\mathcal{O}_\infty \otimes A, D)$ be the isomorphism induced by the KK -equivalence of \mathbf{C} and \mathcal{O}_∞ . Both i and j are natural transformations. Using Theorem 2.1.5 and Proposition 2.1.11, we can rewrite $j_{\mathcal{O}_\infty \otimes D}(\mu)$ as $(\delta_0 \otimes \text{id}_D)_*(1_{\mathcal{O}_\infty} \otimes \mu)$. This formula and Remark 3.1.5 imply that $i_D \circ \alpha_D = \alpha_D \circ j_D$ when D is unital and $\mathcal{O}_\infty \otimes D \cong D$. The previous paragraph and the definition of $\tilde{E}_A(D)$ in terms of $[[A, D^\#]]_+$ now imply that $i_D \circ \alpha_D = \alpha_D \circ j_D$ for all D . A related argument shows that also $j_D \circ \beta_D = \beta_D \circ i_D$ for all D .

It now suffices to prove that i_D is an isomorphism for all D . By naturality, split exactness, and the Five Lemma, it suffices to do so for unital D . In this case, we have

$$i_D : [[A, K \otimes \mathcal{O}_\infty \otimes D]]_+ \rightarrow [[\mathcal{O}_\infty \otimes A, K \otimes \mathcal{O}_\infty \otimes D]]_+$$

given by $i_D([[\eta]]) = [[\delta \otimes \text{id}_D]] \cdot [[\text{id}_{\mathcal{O}_\infty} \otimes \eta]]$. Define a map k_D in the opposite direction by restriction to $1 \otimes A \subset \mathcal{O}_\infty \otimes A$. We prove that $k_D = i_D^{-1}$.

Let $\tilde{\delta}(x) = \delta(1 \otimes x)$. Proposition 2.1.11 implies that there is a homotopy $\tilde{\delta} \simeq \text{id}_{K \otimes \mathcal{O}_\infty}$. It is easy to check directly that $k_D \circ i_D$ sends $[[\eta]]$ to $[[\tilde{\delta} \otimes \text{id}_D \circ \eta]]$, so $k_D \circ i_D$ is the identity. For the reverse composition, let τ_A be the inclusion of $A = 1 \otimes A$ in $\mathcal{O}_\infty \otimes A$, and let $\varphi : \mathcal{O}_\infty \otimes \mathcal{O}_\infty \rightarrow \mathcal{O}_\infty \otimes \mathcal{O}_\infty$ be the flip $\varphi(x \otimes y) = y \otimes x$. Then $\varphi \simeq \text{id}_{\mathcal{O}_\infty \otimes \mathcal{O}_\infty}$ by Proposition 2.1.11 and Theorem 2.1.5. Therefore, for $[[\eta]] \in [[\mathcal{O}_\infty \otimes A, K \otimes \mathcal{O}_\infty \otimes D]]_+$, we have

$$\begin{aligned} & (\delta \otimes \text{id}_D) \circ (\text{id}_{\mathcal{O}_\infty} \otimes (\eta \circ \tau_A)) \\ & \simeq (\delta \otimes \text{id}_D) \circ (\text{id}_{\mathcal{O}_\infty} \otimes \eta) \circ (\varphi \otimes \text{id}_A) \circ (\text{id}_{\mathcal{O}_\infty} \otimes \tau_A) = (\tilde{\delta} \otimes \text{id}_D) \circ \eta \simeq \eta. \end{aligned}$$

This shows that $i_D \circ k_D$ is the identity. \square

3.2.7 REMARK. We used Corollary 2.3.10 in this proof because we had it available. It is, however, not necessary for the argument. Using methods similar to, but a bit more complicated than, the proof of Lemma 3.2.3, one can show that if F as there is in fact a functor on homotopy classes of asymptotic morphisms, then $F([[\varphi]])$ is equal to \hat{F} applied to the KK -theory class given by φ .

3.2.8 THEOREM. Let A be a separable unital nuclear simple C^* -algebra. Then for separable unital C^* -algebras D , the set of homotopy classes of full asymptotic morphisms from A to $K \otimes \mathcal{O}_\infty \otimes D$ is naturally isomorphic to $KK^0(A, D)$ via the map sending an asymptotic morphism to the KK -class it determines.

Proof: This follows from Theorem 3.2.6 and Remark 3.1.5. \square

4 THEOREMS ON KK -THEORY AND CLASSIFICATION

In this section, we present our main results. The first subsection contains the alternate descriptions of KK -theory in terms of homotopy classes and asymptotic unitary equivalence classes of homomorphisms, in case the first variable is separable, nuclear, unital, and simple. We also give here a proof that homotopies of automorphisms of separable nuclear unital purely infinite simple C^* -algebras can in fact be chosen to be isotopies. The second subsection contains the classification theorem and its corollaries. The third subsection contains the nonclassification results.

4.1 DESCRIPTIONS OF KK -THEORY

Probably the most striking of our descriptions of KK -theory is the following:

4.1.1 THEOREM. For a separable unital nuclear simple C^* -algebra A and a separable unital C^* -algebra D , the obvious maps define natural isomorphisms of abelian groups between the following three objects:

- (1) The set of asymptotic unitary equivalence classes of full homomorphisms from A to $K \otimes \mathcal{O}_\infty \otimes D$, with the operation given by direct sum (Definition 1.1.3).
- (2) The set of homotopy classes of full homomorphisms from A to $K \otimes \mathcal{O}_\infty \otimes D$, with the operation given by direct sum as above.
- (3) The group $KK^0(A, D)$.

Proof: For the purposes of this proof, denote the set in (1) by $KU(A, D)$ and the set in (2) by $KH(A, D)$. The map from $KH(A, D)$ to $KK^0(A, D)$ is the one from Theorem 3.2.8. By this theorem, we can use $[[A, K \otimes \mathcal{O}_\infty \otimes D]]_+$ in place of $KK^0(A, D)$.

Lemma 1.3.3 (2) implies that the map from $KU(A, D)$ to $KH(A, D)$ is well defined, and it is then clearly surjective. Injectivity is immediate from Theorem 2.3.7. Thus this map is an isomorphism. Theorem 3.2.8 implies that the map from $KH(A, D)$ to $[[A, K \otimes \mathcal{O}_\infty \otimes D]]_+$ is injective, while Corollary 2.3.10 implies that the map from $KU(A, D)$ to $[[A, K \otimes \mathcal{O}_\infty \otimes D]]_+$ is surjective. Therefore these maps are in fact both isomorphisms. It now follows that $KU(A, D)$ and $KH(A, D)$ are both abelian groups. \square

We now want to give a stable version of this theorem, in which the Kasparov product will reduce exactly to composition of homomorphisms. We need the following lemma. The hypotheses allow one continuous path of homomorphisms, and require unitaries in $U_0((K \otimes D)^+)$, for use in the next subsection.

4.1.2 LEMMA. Let A be separable, nuclear, unital, and simple, let D_0 be separable and unital, and let $D = \mathcal{O}_\infty \otimes D_0$. Let $t \mapsto \varphi_t$, for $t \in [0, \infty)$, be a continuous path of full homomorphisms from $K \otimes A$ to $K \otimes D$, and let $\psi : K \otimes A \rightarrow K \otimes D$ be a full homomorphism. Assume that $[\varphi_0] = [\psi]$ in $KK^0(A, D)$. Then there is an asymptotic unitary equivalence from φ to ψ which consists of unitaries in $U_0((K \otimes D)^+)$.

Proof: Let $\{e_{ij}\}$ be a system of matrix units for K . Identify A with the subalgebra $e_{11} \otimes A$ of $K \otimes A$. Define $\varphi_t^{(0)}$ and $\psi^{(0)}$ to be the restrictions of φ_t and ψ to A . Then $[\varphi_0^{(0)}] = [\psi^{(0)}]$ in $KK^0(A, D)$. It follows from Theorem 4.1.1 that $\varphi_0^{(0)}$ is homotopic to $\psi^{(0)}$. Therefore $\varphi^{(0)}$ and $\psi^{(0)}$ are homotopic as asymptotic morphisms, and Theorem 2.3.7 provides an asymptotic unitary equivalence $t \mapsto u_t$ in $U((K \otimes D)^+)$ from $\varphi^{(0)}$ to $\psi^{(0)}$. Let $c \in U((K \otimes D)^+)$ be a unitary with

$c\psi^{(0)}(1) = \psi^{(0)}(1)c = \psi^{(0)}(1)$ and such that c is homotopic to u_0^{-1} . Then c commutes with every $\psi^{(0)}(a)$. Replacing u_t by cu_t , we obtain an asymptotic unitary equivalence, which we again call $t \mapsto u_t$, from $\varphi^{(0)}$ to $\psi^{(0)}$ which is in $U_0((K \otimes D)^+)$.

Define $\bar{e}_{ij} = e_{ij} \otimes 1$. Then in particular $u_t\varphi_t(\bar{e}_{11})u_t^* \rightarrow \psi(\bar{e}_{11})$ as $t \rightarrow \infty$. Therefore there is a continuous path $t \rightarrow z_t^{(1)} \in U_0((K \otimes D)^+)$ such that $z_t^{(1)} \rightarrow 1$ and $z_t^{(1)}u_t\varphi_t(\bar{e}_{11})u_t^*(z_t^{(1)})^* = \psi(\bar{e}_{11})$ for all t . We still have $z_t^{(1)}u_t\varphi_t(e_{11} \otimes a)u_t^*(z_t^{(1)})^* \rightarrow \psi(e_{11} \otimes a)$ for $a \in A$.

For convenience, set $f_{ijt} = z_t^{(1)}u_t\varphi_t(\bar{e}_{ij})u_t^*(z_t^{(1)})^*$, for all t and for $1 \leq i, j \leq 2$. For each fixed t , the f_{ijt} are matrix units, and $f_{11t} = \psi(\bar{e}_{11})$. Set $w_t = \psi(\bar{e}_{21})f_{12t} + 1 - f_{22t} \in U((K \otimes D)^+)$. Then one checks that $w_t f_{ijt} w_t^* = \psi(\bar{e}_{ij})$ for all t and for $1 \leq i, j \leq 2$. Choose $c \in U((K \otimes D)^+)$ with

$$c\psi(\bar{e}_{11} + \bar{e}_{22}) = \psi(\bar{e}_{11} + \bar{e}_{22})c = \psi(\bar{e}_{11} + \bar{e}_{22}) \quad \text{and} \quad cw_1 \in U_0((K \otimes D)^+).$$

Set $z_t^{(2)} = cw_t$ for $t \geq 1$ and extend $z_t^{(2)}$ over $[0, 1]$ to be continuous, unitary, and satisfy $z_0^{(2)} = 1$. This gives $z_t^{(2)} = 1$ for $t = 0$, $z_t^{(2)}\psi(\bar{e}_{11}) = \psi(\bar{e}_{11})z_t^{(2)} = \psi(\bar{e}_{11})$ for all t , and

$$z_t^{(2)} \left[z_t^{(1)} u_t \varphi_t(\bar{e}_{ij}) u_t^* (z_t^{(1)})^* \right] (z_t^{(2)})^* = \psi(\bar{e}_{ij})$$

for $t \geq 1$ and $1 \leq i, j \leq 2$.

We continue inductively, obtaining by the same method a sequence of continuous paths $t \mapsto z_t^{(n)}$ such that $z_t^{(n+1)} = 1$ for $t \leq n - 1$,

$$z_t^{(n+1)} \left(\sum_{j=1}^n \psi(\bar{e}_{jj}) \right) = \left(\sum_{j=1}^n \psi(\bar{e}_{jj}) \right) z_t^{(n+1)} = \sum_{j=1}^n \psi(\bar{e}_{jj})$$

for all t , and

$$z_t^{(n+1)} \left[\left(z_t^{(1)} z_t^{(2)} \cdots z_t^{(n)} \right) u_t \varphi_t(\bar{e}_{ij}) u_t^* \left(z_t^{(1)} z_t^{(2)} \cdots z_t^{(n)} \right)^* \right] (z_t^{(n+1)})^* = \psi(\bar{e}_{ij})$$

for $t \geq n$ and $1 \leq i, j \leq n + 1$.

Now define

$$z_t = \left(\lim_{n \rightarrow \infty} z_t^{(1)} z_t^{(2)} \cdots z_t^{(n)} \right) u_t.$$

In a neighborhood of each t , all but finitely many of the $z_t^{(k)}$ are equal to 1, so this limit of products yields a continuous path of unitaries in $U_0((K \otimes D)^+)$. Moreover, $z_t\varphi_t(\bar{e}_{ij})z_t^* = \psi(\bar{e}_{ij})$ whenever $t \geq i, j$, so that $\lim_{t \rightarrow \infty} z_t\varphi_t(\bar{e}_{ij})z_t^* = \psi(\bar{e}_{ij})$ for all i and j , while

$$\lim_{t \rightarrow \infty} z_t\varphi_t(e_{11} \otimes a)z_t^* = \lim_{t \rightarrow \infty} z_t^{(1)} u_t\varphi_t(e_{11} \otimes a)u_t^*(z_t^{(1)})^* = \psi(e_{11} \otimes a)$$

for all $a \in A$. Since the \bar{e}_{ij} and $e_{11} \otimes a$ generate $K \otimes A$, this shows that $t \mapsto z_t$ is an asymptotic unitary equivalence. \square

4.1.3 THEOREM. For a separable unital nuclear simple C^* -algebra A and a separable unital C^* -algebra D , the obvious maps and the isomorphism $KK^0(A, D) \rightarrow KK^0(K \otimes \mathcal{O}_\infty \otimes A, K \otimes \mathcal{O}_\infty \otimes D)$ define natural isomorphisms of abelian groups between the following three objects:

- (1) The set of asymptotic unitary equivalence classes of full homomorphisms from $K \otimes \mathcal{O}_\infty \otimes A$ to $K \otimes \mathcal{O}_\infty \otimes D$, with the operation given by direct sum (as in Theorem 4.1.1).
- (2) The set of homotopy classes of full homomorphisms from $K \otimes \mathcal{O}_\infty \otimes A$ to $K \otimes \mathcal{O}_\infty \otimes D$, with the operation given by direct sum as above.
- (3) The group $KK^0(A, D)$.

Moreover, if B is another a separable unital nuclear simple C^* -algebra, then the Kasparov product $KK^0(A, B) \times KK^0(B, D) \rightarrow KK^0(A, D)$ is given in the groups in (1) and (2) by composition of homomorphisms.

Proof: The last statement will follow immediately from the rest of the theorem, since if two KK -classes are represented by homomorphisms, then their product is represented by the composition.

For the rest of the theorem, first note that the map $KK^0(A, D) \rightarrow KK^0(K \otimes \mathcal{O}_\infty \otimes A, K \otimes \mathcal{O}_\infty \otimes D)$ is a natural isomorphism because it is induced by the KK -equivalence $\mathbf{C} \rightarrow K \otimes \mathcal{O}_\infty$, given by $1 \mapsto e \otimes 1$ for some rank one projection $e \in K$, in each variable.

Now observe that the previous lemma implies that the map from the set in (1) to $KK^0(A, D)$ is injective. Moreover, the map from the set in (1) to the set in (2) is well defined by Lemma 1.3.3 (2), and is then obviously surjective. It therefore suffices to prove that the map from the set in (2) to $KK^0(A, D)$ is surjective, that is, that every class in $KK^0(A, D)$ is represented by a homomorphism from $K \otimes \mathcal{O}_\infty \otimes A$ to $K \otimes \mathcal{O}_\infty \otimes D$. It follows from Theorem 4.1.1 that every such class is represented by a homomorphism from A to $K \otimes \mathcal{O}_\infty \otimes D$, and we obtain a homomorphism from $K \otimes \mathcal{O}_\infty \otimes A$ to $K \otimes \mathcal{O}_\infty \otimes D$ by tensoring with $\text{id}_{K \otimes \mathcal{O}_\infty}$ and composing with the tensor product of id_D and an isomorphism $K \otimes \mathcal{O}_\infty \otimes K \otimes \mathcal{O}_\infty \rightarrow K \otimes \mathcal{O}_\infty$ which is the identity on K -theory. \square

We finish this section with one other application. Following terminology from differential topology, we define an *isotopy* to be a homotopy $t \mapsto \varphi_t$ in which each φ_t is an isomorphism.

4.1.4 THEOREM. Let A be a separable nuclear unital purely infinite simple C^* -algebra.

- (1) If $U(A)$ is connected, then two automorphisms of A with the same class in $KK^0(A, A)$ are isotopic.
- (2) Any two automorphisms of $K \otimes A$ with the same class in $KK^0(A, A)$ are isotopic.

Proof: For (2), take $D = A$ in Lemma 4.1.2, note that $\mathcal{O}_\infty \otimes A \cong A$ (Theorem 2.1.5), and note that an asymptotic unitary equivalence with unitaries in $U_0((K \otimes A)^+)$ gives an isotopy, not just a homotopy.

For (1), let φ and ψ be automorphisms of A with the same class in $KK^0(A, A)$. Let $e \in K$ be a rank one projection. Apply (2) to $\text{id}_K \otimes \varphi$ and $\text{id}_K \otimes \psi$. Thus, there is a unitary path $t \mapsto u_t$ in $(K \otimes A)^+$ with $u_t \varphi(e \otimes a) u_t^* \rightarrow \psi(e \otimes a)$ for $a \in A$. In particular, $u_t(e \otimes 1) u_t^* \rightarrow (e \otimes 1)$. Replacing u_t by $v_t u_t$ for a suitable unitary path $t \mapsto v_t$, we may therefore assume that $u_t(e \otimes 1) u_t^* = e \otimes 1$ for all t . Cut down by $e \otimes 1$, and observe that the hypotheses imply that $(e \otimes 1) u_0 (e \otimes 1)$ is homotopic to 1. Now finish as in the proof of (2). \square

4.2 THE CLASSIFICATION THEOREM

The following theorem is the stable version of the main classification theorem. Everything else will be an essentially immediate corollary.

In the proof, it is easy to get the existence of the isomorphism; this is just the by now well known Elliott approximate intertwining argument. We need a more complicated version of this argument to make sure that the isomorphism we construct has the right class in KK -theory: we construct a suitable homotopy at the same time that we construct the isomorphism. One might hope to prove that if A and B are separable C^* -algebras, and if $\varphi_0 : A \rightarrow B$ and $\psi_0 : B \rightarrow A$ are homomorphisms such that $\psi_0 \circ \varphi_0$ is asymptotically unitarily equivalent to id_A and $\varphi_0 \circ \psi_0$ is asymptotically unitarily equivalent to id_B , then there is an isomorphism $\varphi : A \rightarrow B$ which is asymptotically unitarily equivalent to φ_0 , or at least is homotopic to φ_0 . Unfortunately, we have not been able to prove this; the arguments in the proof below don't seem to quite give such a result.

4.2.1 THEOREM. Let A and B be separable nuclear unital purely infinite simple C^* -algebras, and suppose that there is an invertible element $\eta \in KK^0(A, B)$. Then there is an isomorphism $\varphi : K \otimes A \rightarrow K \otimes B$ such $[\varphi] = \eta$ in $KK^0(A, B)$.

Proof: Theorems 3.2.8 and 2.1.5 provide a full asymptotic morphism $\alpha : A \rightarrow K \otimes B$ whose class in $KK^0(A, B)$ is η . By Corollary 2.3.10, we may in fact take α to be a homomorphism. Let $\mu : K \otimes K \rightarrow K$ be an isomorphism, and set $\varphi_0 = (\mu \otimes \text{id}_B) \circ (\text{id}_K \otimes \alpha)$. Then φ_0 is a nonzero (hence full) homomorphism from $K \otimes A$ to $K \otimes B$ whose class in $KK^0(A, B)$ is also η . Similarly, there is a full homomorphism $\psi_0 : K \otimes B \rightarrow K \otimes A$ whose class in $KK^0(B, A)$ is η^{-1} . It follows from Theorems 4.1.3 and 2.1.5 that $\psi_0 \circ \varphi_0$ is homotopic to $\text{id}_{K \otimes A}$ and $\varphi_0 \circ \psi_0$ is homotopic to $\text{id}_{K \otimes B}$.

We now construct homomorphisms $\varphi^{(n)} : K \otimes A \rightarrow K \otimes B$, $\psi^{(n)} : K \otimes B \rightarrow K \otimes A$, homotopies $\alpha \mapsto \tilde{\varphi}_\alpha^{(n)}$ (for $\alpha \in [0, 1]$) of homomorphisms from $K \otimes A$ to $K \otimes B$, and finite subsets $F_n \subset K \otimes A$ and $G_n \subset K \otimes B$ such that the following

conditions are satisfied:

- (1) $\varphi^{(0)} = \varphi_0$.
- (2) Each $\varphi^{(n)}$ is of the form $a \mapsto v\varphi_0(a)v^*$ for some suitable $v \in U_0((K \otimes B)^+)$, and similarly each $\psi^{(n)}$ is of the form $b \mapsto u\varphi_0(b)u^*$ for some suitable $u \in U_0((K \otimes A)^+)$.
- (3) $F_0 \subset F_1 \subset \dots$ and $\bigcup_{n=0}^\infty F_n$ is dense in $K \otimes A$, and similarly $G_0 \subset G_1 \subset \dots$ and $\bigcup_{n=0}^\infty G_n$ is dense in $K \otimes B$.
- (4) $\varphi^{(n)}(F_n) \subset G_n$ and $\psi^{(n)}(G_n) \subset F_{n+1}$.
- (5) $\|\psi^{(n)} \circ \varphi^{(n)}(a) - a\| < 2^{-n}$ for $a \in F_n$ and $\|\varphi^{(n+1)} \circ \psi^{(n)}(b) - b\| < 2^{-n}$ for $b \in G_n$.
- (6) $\|\tilde{\varphi}_\alpha^{(n+1)}(a) - \tilde{\varphi}_\alpha^{(n)}(a)\| < 2^{-n}$ for $a \in F_n$ and $\alpha \in [0, 1]$.
- (7) $\tilde{\varphi}_\alpha^{(n)} = \varphi_0$ for $\alpha \geq 1 - 2^{-n}$ and $\tilde{\varphi}_0^{(n)} = \varphi^{(n)}$.

This will yield the following approximately commutative diagram:

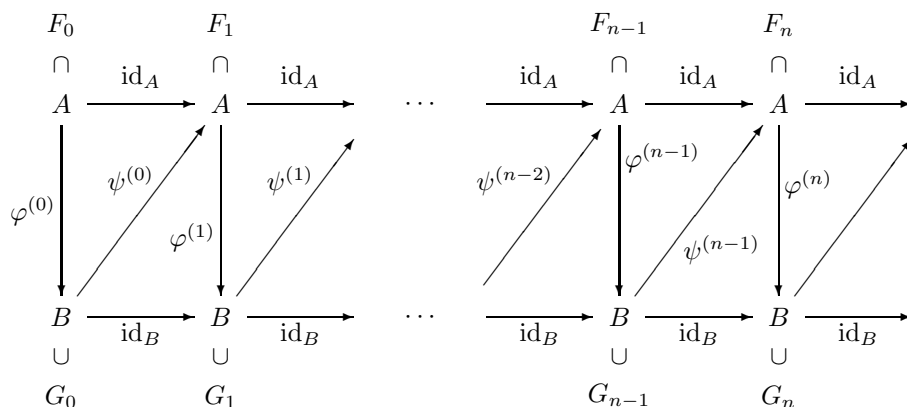

The diagram will remain approximately commutative if we replace each $\varphi^{(n)}$ by $\tilde{\varphi}_\alpha^{(n)}$ (with $\alpha \in [0, 1]$ fixed) and delete the diagonal arrows.

The proof is by induction on n . We start by choosing finite sets

$$F_0^{(0)} \subset F_1^{(0)} \subset \dots \subset K \otimes A \quad \text{and} \quad G_0^{(0)} \subset G_1^{(0)} \subset \dots \subset K \otimes B$$

such that $\overline{\bigcup_{n=0}^\infty F_n^{(0)}} = K \otimes A$ and $\overline{\bigcup_{n=0}^\infty G_n^{(0)}} = K \otimes B$. For the initial step of the induction, we take $F_0 = F_0^{(0)}$, $\varphi^{(0)} = \tilde{\varphi}_\alpha^{(0)} = \varphi_0$, and $G_0 = G_0^{(0)} \cup \varphi^{(0)}(F_0)$. We then assume we are given F_k , $\varphi^{(k)}$, G_k , and $\varphi_\alpha^{(k)}$ for $0 \leq k \leq n$ and $\psi^{(k)}$ for $0 \leq k \leq n - 1$, and we construct $\psi^{(n)}$, F_{n+1} , $\varphi^{(n+1)}$, G_{n+1} , and $\alpha \mapsto \tilde{\varphi}_\alpha^{(n+1)}$. That is, we are given the diagram above through the column containing F_n and G_n , as well as the corresponding homotopies $\tilde{\varphi}^{(k)}$, and we construct the

next rectangle (consisting of two triangles) and the corresponding homotopy $\tilde{\varphi}^{(n+1)}$.

Define $\sigma : K \otimes A \rightarrow C([0, 1]) \otimes K \otimes A$ by $\sigma(a)(\alpha) = \psi_0(\tilde{\varphi}_\alpha^{(n)}(a))$. Note that σ is homotopic to $a \mapsto 1 \otimes \psi_0(\varphi_0(a))$, and so has the same class in KK -theory as $a \mapsto 1 \otimes a$. Lemma 4.1.2 provides a unitary path $(\alpha, t) \mapsto u_{\alpha,t} \in U_0((K \otimes A)^+)$ such that

$$\lim_{t \rightarrow \infty} \sup_{\alpha \in [0,1]} \|u_{\alpha,t} \psi_0(\tilde{\varphi}_\alpha^{(n)}(a)) u_{\alpha,t}^* - a\| = 0$$

for all $a \in K \otimes A$. Next, define an asymptotic morphism τ from $K \otimes B$ to $C([0, 1]) \otimes K \otimes B$ by $\tau_t(b)(\alpha) = \varphi_0(u_{\alpha,t} \psi_0(b) u_{\alpha,t}^*)$. Then τ is homotopic to $b \mapsto 1 \otimes \varphi_0(\psi_0(b))$, and so has the same class in KK -theory as $b \mapsto 1 \otimes b$. Again by Lemma 4.1.2, there is a unitary path $(\alpha, t) \mapsto v_{\alpha,t} \in U_0((K \otimes B)^+)$ such that

$$\lim_{t \rightarrow \infty} \sup_{\alpha \in [0,1]} \|v_{\alpha,t} \varphi_0(u_{\alpha,t} \psi_0(b) u_{\alpha,t}^*) v_{\alpha,t}^* - b\| = 0$$

for all $b \in K \otimes B$.

Since $\tilde{G} = G_n \cup \bigcup_{\alpha \in [0,1]} \tilde{\varphi}_\alpha^{(n)}(F_n)$ is a compact subset of $K \otimes B$, we can choose T so large that

$$\|v_{\alpha,t} \varphi_0(u_{\alpha,t} \psi_0(b) u_{\alpha,t}^*) v_{\alpha,t}^* - b\| < 2^{-(n+1)}$$

for all $b \in \tilde{G}$ and $t \geq T$. Increasing T if necessary, we can also require

$$\|u_{\alpha,t} \psi_0(\tilde{\varphi}_\alpha^{(n)}(a)) u_{\alpha,t}^* - a\| < 2^{-(n+1)}$$

for all $a \in F_n$ and $t \geq T$. Now define

$$\psi^{(n)}(b) = u_{0,T} \psi_0(b) u_{0,T}^* \quad \text{and} \quad \varphi^{(n+1)}(a) = v_{0,T} \varphi_0(a) v_{0,T}^*,$$

and

$$F_{n+1} = F_{n+1}^{(0)} \cup F_n \cup \psi^{(n)}(G_n) \quad \text{and} \quad G_{n+1} = G_{n+1}^{(0)} \cup G_n \cup \varphi^{(n+1)}(F_{n+1}).$$

The relevant parts of conditions (2)–(4) are then certainly satisfied. For (5), we have in fact

$$\|\psi^{(n)} \circ \varphi^{(n)}(a) - a\| = \|u_{0,T} \psi_0(\tilde{\varphi}_0^{(n)}(a)) u_{0,T}^* - a\| < 2^{-(n+1)}$$

for $a \in F_n$ by the choice of T , and similarly

$$\|\varphi^{(n+1)} \circ \psi^{(n)}(b) - b\| = \|v_{0,T} \varphi_0(u_{0,T} \psi_0(b) u_{0,T}^*) v_{0,T}^* - b\| < 2^{-(n+1)}$$

for $b \in G_n$.

Now choose a continuous function $f : [0, 1 - 2^{-(n+1)}) \rightarrow [T, \infty)$ such that $f(\alpha) = T$ for $0 \leq \alpha \leq 1 - 2^{-n}$ and $f(\alpha) \rightarrow \infty$ as $\alpha \rightarrow 1 - 2^{-(n+1)}$. Define $\alpha \mapsto \tilde{\varphi}_\alpha^{(n+1)}$ by

$$\tilde{\varphi}_\alpha^{(n+1)}(a) = \begin{cases} v_{\alpha,f(\alpha)} \varphi_0(a) v_{\alpha,f(\alpha)}^* & 0 \leq \alpha < 1 - 2^{-(n+1)} \\ \varphi_0(a) & 1 - 2^{-(n+1)} \leq \alpha \leq 1. \end{cases}$$

We first have to show that the functions $\alpha \mapsto \tilde{\varphi}_\alpha^{(n+1)}(a)$ are continuous at $1 - 2^{-(n+1)}$ for $a \in K \otimes A$. Set $\alpha_0 = 1 - 2^{-(n+1)}$, and consider α with $1 - 2^{-n} \leq \alpha < 1 - 2^{-(n+1)}$. By the induction hypothesis, we then have $\tilde{\varphi}_\alpha^{(n)}(a) = \varphi_0(a)$. For $a \in K \otimes A$, set $b = \varphi_0(a)$; then

$$\begin{aligned} & \|\tilde{\varphi}_\alpha^{(n+1)}(a) - \tilde{\varphi}_{\alpha_0}^{(n+1)}(a)\| \\ & \leq \|a - u_{\alpha, f(\alpha)}\psi_0(\tilde{\varphi}_\alpha^{(n)}(a))u_{\alpha, f(\alpha)}^*\| \\ & \quad + \|v_{\alpha, f(\alpha)}\varphi_0(u_{\alpha, f(\alpha)}\psi_0(b)u_{\alpha, f(\alpha)}^*)v_{\alpha, f(\alpha)}^* - b\|. \end{aligned}$$

The requirement that $f(\alpha) \rightarrow \infty$ as $\alpha \rightarrow 1 - 2^{-(n+1)}$, together with the condition of uniformity in α in the limits used in the choices of $u_{\alpha, t}$ and $v_{\alpha, t}$, implies that both terms on the right converge to 0. So the required continuity holds.

The relevant part of condition (7) is satisfied by definition, so it remains only to check (6). We may assume $\alpha < 1 - 2^{-(n+1)}$. So let $a \in F_n$. Then $b = \tilde{\varphi}_\alpha^{(n)}(a) \in \tilde{G}$. So

$$\begin{aligned} & \|\tilde{\varphi}_\alpha^{(n+1)}(a) - \tilde{\varphi}_\alpha^{(n)}(a)\| \\ & \leq \sup_{\alpha \in [0, 1], t \geq T} \|v_{\alpha, t}\varphi_0(a)v_{\alpha, t}^* - \tilde{\varphi}_\alpha^{(n)}(a)\| \\ & \leq \sup_{\alpha \in [0, 1], t \geq T} \|a - u_{\alpha, t}\psi_0(\tilde{\varphi}_\alpha^{(n)}(a))u_{\alpha, t}^*\| \\ & \quad + \sup_{\alpha \in [0, 1], t \geq T} \|v_{\alpha, t}\varphi_0(u_{\alpha, t}\psi_0(b)u_{\alpha, t}^*)v_{\alpha, t}^* - b\| \\ & < 2^{-(n+1)} + 2^{-(n+1)} = 2^{-n}. \end{aligned}$$

This proves (6), and finishes the inductive construction. Note that the set $\bigcup_{n=0}^\infty F_n$ is dense in $K \otimes A$ because it contains the dense subset $\bigcup_{n=0}^\infty F_n^{(0)}$, and similarly $\bigcup_{n=0}^\infty G_n$ is dense in $K \otimes B$.

We now define $\varphi : K \otimes A \rightarrow K \otimes B$ by $\varphi(a) = \lim_{n \rightarrow \infty} \varphi^{(n)}(a)$, and define $\psi : K \otimes B \rightarrow K \otimes A$ and the homotopy $\tilde{\varphi} : K \otimes A \rightarrow C([0, 1]) \otimes K \otimes B$ analogously. As in Section 2 of [20], these limits all exist and define homomorphisms; moreover, $\psi \circ \varphi = \text{id}_{K \otimes A}$, $\varphi \circ \psi = \text{id}_{K \otimes B}$, $\tilde{\varphi}_0 = \varphi$, and $\tilde{\varphi}_1 = \varphi_0$. So φ is an isomorphism from $K \otimes A$ to $K \otimes B$ which is homotopic to φ_0 and therefore satisfies $[\varphi] = \eta$ in $KK^0(A, B)$. \square

4.2.2 COROLLARY. Let A and B be separable nuclear unital purely infinite simple C^* -algebras, and suppose that there is an invertible element $\eta \in KK^0(A, B)$ such that $[1_A] \times \eta = [1_B]$. Then there is an isomorphism $\varphi : A \rightarrow B$ such $[\varphi] = \eta$ in $KK^0(A, B)$.

Proof: The previous theorem provides an isomorphism $\alpha : K \otimes A \rightarrow K \otimes B$ such that $[\alpha] = \eta$ in $KK^0(A, B)$. Choose a rank one projection $e \in K$. Then $[\alpha(e \otimes 1_A)] = [1_A] \times \eta = [e \otimes 1_B]$ in $K_0(B)$. Since $K \otimes B$ is purely infinite simple, it follows that there is a unitary $u \in (K \otimes B)^+$ such that $u\alpha(e \otimes 1_A)u^* = e \otimes 1_B$. Define $\varphi(a) = u\alpha(e \otimes a)u^*$, regarded as an element of $(e \otimes 1_B)(K \otimes B)(e \otimes 1_B) = B$. \square

The remaining corollaries require some hypotheses on the Universal Coefficient Theorem. (See [53].) The following terminology is convenient.

4.2.3 DEFINITION. Let A and D be separable nuclear C^* -algebras. We say that the pair (A, D) satisfies the *Universal Coefficient Theorem* if the sequence

$$0 \longrightarrow \text{Ext}_1^{\mathbb{Z}}(K_*(A), K_*(D)) \longrightarrow KK^0(A, D) \longrightarrow \text{Hom}(K_*(A), K_*(D)) \longrightarrow 0$$

of Theorem 1.17 of [53] is defined and exact. (Note that the second map is always defined, and the first map is the inverse of a map that is always defined.) We further say that A satisfies the Universal Coefficient Theorem if (A, D) does for every separable C^* -algebra D .

4.2.4 THEOREM. Let A and B be separable nuclear purely infinite simple C^* -algebras which satisfy the Universal Coefficient Theorem. Assume that A and B are either both unital or both nonunital. If there is a graded isomorphism $\alpha : K_*(A) \rightarrow K_*(B)$ which (in the unital case) satisfies $\alpha_*([1_A]) = [1_B]$, then there is an isomorphism $\varphi : A \rightarrow B$ such that $\varphi_* = \alpha$.

Proof: The proof of Proposition 7.3 of [53] shows that there is a KK -equivalence $\eta \in KK^0(A, B)$ which induces α . Now use Theorem 4.2.1 or Corollary 4.2.2 as appropriate. \square

This theorem gives all the classification results of [48], [49], [34], [22], [35], [51], [36], [44], and [52]. Of course, we have used the main technical theorem of [48], as well as substantial material from [35], in the proof. We do not obtain anything new about the Rokhlin property of [8]; indeed, our results show that the C^* -algebras of [51] are classifiable as long as they are purely infinite and simple, regardless of whether the Rokhlin property is satisfied. On the other hand, the Rokhlin property has been verified in many cases; see [30] and [31].

We finish this section by giving some further corollaries. Let \mathcal{C} be the “classifiable class” given in Definition 5.1 of [22], and let \mathcal{N} denote the bootstrap category of [53], for which the Universal Coefficient Theorem was shown to hold (Theorem 1.17 of [53]).

4.2.5 THEOREM. Let G_0 and G_1 be countable abelian groups, and let $g \in G_0$. Then:

(1) There is a separable nuclear unital purely infinite simple C^* -algebra $A \in \mathcal{N}$ such that

$$(K_0(A), [1_A], K_1(A)) \cong (G_0, g, G_1).$$

(2) There is a separable nuclear nonunital purely infinite simple C^* -algebra $A \in \mathcal{N}$ such that

$$(K_0(A), K_1(A)) \cong (G_0, G_1).$$

Proof: The construction of Theorem 5.6 of [22] gives algebras which are easily seen to be in \mathcal{N} . \square

4.2.6 COROLLARY. Every C^* -algebra in \mathcal{C} is in \mathcal{N} . Every purely infinite simple C^* -algebra in \mathcal{N} , and more generally every separable nuclear purely infinite simple C^* -algebra satisfying the Universal Coefficient Theorem, is in \mathcal{C} .

Proof: The first part follows immediately from the previous theorem, since it follows from the definition of \mathcal{C} that any $A \in \mathcal{C}$ must be isomorphic to the C^* -algebra of that theorem with the same K -theory. The second part follows from Theorem 4.2.4, since Theorem 1.17 of [53] states that every C^* -algebra in \mathcal{N} satisfies the Universal Coefficient Theorem. \square

4.2.7 COROLLARY. Let $A \in \mathcal{C}$, and let B be a separable nuclear unital simple C^* -algebra which satisfies the Universal Coefficient Theorem. (In particular, B could be a unital simple C^* -algebra in \mathcal{N} .) Then $A \otimes B \in \mathcal{C}$.

Proof: The C^* -algebra $A \otimes B$ is separable, nuclear, unital, and simple, and Theorem 7.7 of [53] (and the remark after this theorem) shows that it satisfies the Universal Coefficient Theorem. Furthermore, A is approximately divisible by Corollary 2.1.6, and it follows from the remark after Theorem 1.4 of [6] that $A \otimes B$ is approximately divisible. Clearly $A \otimes B$ is infinite, so it is purely infinite by Theorem 1.4 (a) of [6]. The result now follows from the previous corollary. \square

4.2.8 COROLLARY. The class \mathcal{C} is closed under tensor products.

4.2.9 COROLLARY. For any $m, n \geq 2$, we have $\mathcal{O}_m \otimes \mathcal{O}_n \in \mathcal{C}$. In particular, if $m - 1$ and $n - 1$ are relatively prime, then $\mathcal{O}_m \otimes \mathcal{O}_n \cong \mathcal{O}_2$.

4.2.10 COROLLARY. Let A_1 and A_2 be two higher dimensional noncommutative toruses of the same dimension, and let B be any simple Cuntz-Krieger algebra. Then $A_1 \otimes B \cong A_2 \otimes B$.

Proof: The Künneth formula [55] shows that $A_1 \otimes B$ and $A_2 \otimes B$ have the same K -theory. \square

4.2.11 THEOREM. Let A be a separable nuclear unital purely infinite simple C^* -algebra satisfying the Universal Coefficient Theorem. Let A^{op} be the opposite algebra, that is, A with the multiplication reversed but all other operations the same. Then $A \cong A^{\text{op}}$.

Proof: The identity map from A to A^{op} is an antiisomorphism which induces an isomorphism on K -theory sending $[1_A]$ to $[1_{A^{\text{op}}}]$. Also, the pair (A^{op}, B) (for any separable B) always satisfies the Universal Coefficient Theorem, because (A, B^{op}) does. \square

By way of contrast, we note that Connes has shown [10] that there is a type III factor not isomorphic to its opposite algebra. It is also known (although apparently not published) that there are nonsimple separable nuclear (even type I) C^* -algebras not isomorphic to their opposite algebras.

4.3 NONCLASSIFICATION

In this subsection, we give some results which show how badly the classification theorem fails if the algebras are not nuclear. The results are mostly either proved elsewhere or follow fairly easily from results proved by other people. There are three main results. First, nonnuclear separable purely infinite simple C^* -algebras need not be approximately divisible in the sense of [6], but whenever A is a purely infinite simple C^* -algebra, then $\mathcal{O}_\infty \otimes A$ is an approximately divisible purely infinite simple C^* -algebra with exactly the same K-theoretic invariants. Second, there are infinitely many mutually nonisomorphic approximately divisible separable exact unital purely infinite simple C^* -algebras A satisfying $K_*(A) = 0$. Finally, given arbitrary countable abelian groups G_0 and G_1 , and $g \in G_0$, there are uncountably many mutually nonisomorphic approximately divisible separable unital purely infinite simple C^* -algebras A satisfying $K_j(A) \cong G_j$ with $[1] \mapsto g_0$. Unfortunately these algebras are not exact, and it remains unknown whether the same is true with the additional requirement of exactness.

The first result is taken straight from a paper of Dykema and Rørdam.

4.3.1 THEOREM. ([18], Theorem 1.4) There exists a separable unital purely infinite simple C^* -algebra which is not approximately divisible.

4.3.2 REMARK. In fact, there exists a separable unital purely infinite simple C^* -algebra A which is not approximately divisible and such that $K_*(A) = 0$.

One way to see this is to modify the proof of Proposition 1.3 of [18] so as to ensure that $K_*(A_n) \rightarrow K_*(B)$ is injective for all n . This is done by enlarging the set X_{n+1} in the proof so as to include appropriate partial isometries (implementing equivalences between projections) and paths of unitaries (implementing triviality of classes of unitaries in K_1). See the proof of Theorem 4.3.11 below for this argument in a related context.

The second result is a fairly easy consequence of a computation of Cowling and Haagerup and of unpublished work of Haagerup. The key invariant is described in the following definition. I am grateful to Uffe Haagerup for explaining the properties of this invariant and where to find proofs of them.

4.3.3 DEFINITION. (Haagerup [23]; also see Section 6 of [12].) Let A be a C^* -algebra. Define $\Lambda(A)$ to be the infimum of numbers C such that there is a net of finite rank operators $T_\alpha : A \rightarrow A$ for which $\|T_\alpha(a) - a\| \rightarrow 0$ for all $a \in A$ and the completely bounded norms satisfy $\sup_\alpha \|T_\alpha\|_{cb} \leq C$. Note that $\Lambda(A) = \infty$ if no such C exists, that is, if A does not have the completely bounded approximation property.

There is a similar definition for von Neumann algebras, in which $T_\alpha(a)$ is required to converge to a in the weak operator topology. (See [23] and Section 6 of [12].) There is also a definition of $\Lambda(G)$ for a locally compact group G , using completely bounded norms of multipliers of G which converge to 1

uniformly on compact sets; see [23] and Section 1 of [12]. We do not formally state the definitions, but we recall the following theorems from [23] (restated as Propositions 6.1 and 6.2 of [12]):

4.3.4 THEOREM. Let Γ be a discrete group, and let $C_r^*(\Gamma)$ and $W^*(\Gamma)$ be its reduced C^* -algebra and von Neumann algebra respectively. Then $\Lambda(\Gamma) = \Lambda(C_r^*(\Gamma)) = \Lambda(W^*(\Gamma))$.

4.3.5 THEOREM. Let G be a second countable locally compact group, and let Γ be a lattice in G . Then $\Lambda(\Gamma) = \Lambda(G)$.

In Section 6 of [12], Cowling and Haagerup exhibit type II_1 factors M_n with $\Lambda(M_n) = 2n - 1$. Using the same results on groups, we exhibit simple C^* -algebras with the same values of Λ .

4.3.6 PROPOSITION. Let Γ_n^0 be as in Corollary 6.6 of [12]. Then $A_n = C_r^*(\Gamma_n^0)$ is a simple separable unital C^* -algebra which satisfies $\Lambda(A_n) = 2n - 1$.

We recall that Γ_n^0 is the quotient by its center of a particular lattice Γ_n in the simple Lie group $\text{Sp}(n, 1)$.

Proof of Proposition 4.3.6: It is shown in the proof of Corollary 6.6 of [12] that $\Lambda(\Gamma_n^0) = 2n - 1$. (This follows from the computation $\Lambda(\text{Sp}(n, 1)) = 2n - 1$, which is the main result of [12], together with Theorem 4.3.5 above and Proposition 1.3 (c) of [12].) Therefore $\Lambda(A_n) = 2n - 1$ by Theorem 4.3.4. Clearly A_n is separable and unital. Simplicity of A_n follows from Theorem 1 of [2], applied to the quotient of $\text{Sp}(n, 1)$ by its center, because (as observed in the introduction to [2]) lattices satisfy the density hypothesis of that theorem. \square

The algebras A_n are not purely infinite, and their K-theory seems to be unknown. So we will tensor them with \mathcal{O}_2 . For this, we need the following result.

4.3.7. LEMMA. Let A be any C^* -algebra, and let B be unital and nuclear. Then $\Lambda(A \otimes B) = \Lambda(A)$.

For von Neumann algebras, it is known [57] that $\Lambda(M \otimes N) = \Lambda(M)\Lambda(N)$. We presume, especially in view of Remark 3.5 of [57], that the analogous statement is true for C^* -algebras as well. However, the special case in the lemma is sufficient here.

Proof of Lemma 4.3.7: If $S : A_1 \rightarrow A_2$ and $T : B_1 \rightarrow B_2$ are completely bounded, then the map $S \otimes_{\min} T : A_1 \otimes_{\min} B_1 \rightarrow A_2 \otimes_{\min} B_2$ is completely bounded, and satisfies $\|S \otimes_{\min} T\|_{\text{cb}} = \|S\|_{\text{cb}}\|T\|_{\text{cb}}$ by Theorem 10.3 of [40]. In Definition 4.3.3, one need only consider elements a of a dense subset, and so it follows that $\Lambda(A \otimes_{\min} B) \leq \Lambda(A)\Lambda(B)$ for any C^* -algebras A and B . For B nuclear, we have $\Lambda(B) = 1$, so $\Lambda(A \otimes B) \leq \Lambda(A)$.

For the reverse inequality, let $R_\alpha : A \otimes B \rightarrow A \otimes B$ be finite rank operators such that $\|R_\alpha(x) - x\| \rightarrow 0$ for all $x \in A \otimes B$. Choose any state ω on B , and

define $T_\alpha : A \rightarrow A$ by $T_\alpha(a) = (\text{id}_B \otimes \omega) \circ R_\alpha(a \otimes 1)$. Theorem 10.3 of [40] implies that $\|T_\alpha\|_{\text{cb}} \leq \|R_\alpha\|_{\text{cb}}$. Also, clearly $\|T_\alpha(a) - a\| \rightarrow 0$ for all $a \in A$. So $\Lambda(A) \leq \Lambda(A \otimes B)$. \square

4.3.8 THEOREM. There exist infinitely many mutually nonisomorphic separable exact unital purely infinite simple C^* -algebras B satisfying $K_*(B) = 0$ and $\mathcal{O}_\infty \otimes B \cong B$. In particular, these algebras are approximately divisible in the sense of [6].

Proof: Let $A_n = C_r^*(\Gamma_n^0)$ as in Proposition 4.3.6. Set $B_n = \mathcal{O}_2 \otimes A_n$. Clearly B_n is separable and unital. Furthermore, B_n is purely infinite simple by the proof of Corollary 4.2.7. We have $\mathcal{O}_\infty \otimes B_n \cong B_n$ because $\mathcal{O}_\infty \otimes \mathcal{O}_2 \cong \mathcal{O}_2$. The algebras B_n are mutually nonisomorphic because $\Lambda(B_n) = 2n - 1$, by the previous lemma and Proposition 4.3.6.

It remains to check exactness. The proof of Corollary 3.12 of [17] shows that if $\Lambda(A)$ is finite, then A has the slice map property (as defined, for example, in Remark 9 of [59], where it is called Property S), and this property implies exactness (see, for example, Section 2.5 of [60]). \square

Our third result is based on the theorem of Junge and Pisier that for $n \geq 3$ the collection of n -dimensional operator spaces is not separable in the completely bounded analog of the Banach-Mazur distance.

4.3.9 DEFINITION. ([25]) Let E and F be operator spaces of the same finite dimension. Then

$$d_{\text{cb}}(E, F) = \inf\{\|T\|_{\text{cb}}\|T^{-1}\|_{\text{cb}} : T \text{ is a linear bijection from } E \text{ to } F\},$$

and $\delta_{\text{cb}}(E, F) = \log(d_{\text{cb}}(E, F))$.

4.3.10 THEOREM. (Theorem 2.3 of [25]) Let OS_n be the set of all complete isometry classes of n -dimensional operator spaces. Let $n \geq 3$. Then $(\text{OS}_n, \delta_{\text{cb}})$ is an inseparable metric space.

4.3.11 THEOREM. Let G_0 and G_1 be countable abelian groups, and let $g \in G_0$. Then there exist uncountable many mutually nonisomorphic separable unital purely infinite simple C^* -algebras A , each with $K_0(A) \cong G_0$ in such a way that $[1] \mapsto g$ and $K_1(A) \cong G_1$, and each satisfying $\mathcal{O}_\infty \otimes A \cong A$.

Proof: If A is a separable C^* -algebra, then the set of (complete isometry classes of) n -dimensional operator subspaces of A is separable (by Proposition 2.6 (a) of [25]). By the previous theorem, it therefore suffices to show that if E is a finite dimensional operator space then there exists a C^* -algebra B having the properties claimed in the theorem and such that E is completely isometric to a subspace of B .

Since E is a finite dimensional operator space, it is a subspace of a separable C^* -algebra A . Represent A on a separable Hilbert space H with infinite multiplicity, and follow this representation with the quotient map from $L(H)$

to the Calkin algebra Q . This gives a completely isometric embedding of E in Q . For convenience, we identify E with its image. Let $u \in Q$ be the image of the unilateral shift; note that $[u]$ generates $K_1(Q)$ and that $K_0(Q) = 0$. Let $B_0 = C^*(E, 1, u) \subset Q$. We now construct by induction an increasing sequence $B_0 \subset B_1 \subset B_2 \subset \dots \subset Q$ of separable C^* -algebras such that B_{2n+1} is simple and such that every nonzero projection in B_{2n-1} is Murray-von Neumann equivalent to 1 in B_{2n} , every selfadjoint element of B_{2n-1} is a limit of selfadjoint elements of B_{2n} with finite spectrum, and every unitary in $U(B_{2n-1}) \cap U_0(Q)$ is homotopic to 1 in B_{2n} .

Given B_{2n} , we choose B_{2n+1} to be any separable simple C^* -algebra with $B_{2n} \subset B_{2n+1} \subset Q$. Such a subalgebra exists by Proposition 2.2 of [3] and the simplicity of Q . Given B_{2n-1} , we note that it suffices to have the required elements of B_{2n} only for countable dense subsets S_1 of the nonzero projections in B_{2n-1} , S_2 of the selfadjoint elements in B_{2n-1} , and S_3 of the unitaries in $U(B_{2n-1}) \cap U_0(Q)$. For each $p \in S_1$, since p is Murray-von Neumann equivalent to 1 in Q , we can choose an isometry $v \in Q$ such that $v^*v = 1$ and $vv^* = p$. Let T_1 be the set of all these as p runs through S_1 . For each $a \in S_2$, since Q has real rank zero, there is a sequence (b_n) in Q consisting of selfadjoint elements with finite spectrum such that $b_n \rightarrow a$. Let T_2 be the set of all terms of all such sequences as a runs through S_2 . For each $u \in S_3$, since $u \in U_0(Q)$, there is a unitary path $t \mapsto v(t)$ in Q with $v(0) = 1$ and $v(1) = u$. Let T_3 consist of all $v(t)$ for $t \in [0, 1] \cap \mathbf{Q}$ as u runs through S_3 . Then take B_{2n} to be the C^* -subalgebra of Q generated by B_{2n-1} and $T_1 \cup T_2 \cup T_3$. This subalgebra is separable because B_{2n-1} is separable and $T_1 \cup T_2 \cup T_3$ is countable.

Now set $B = \bigcup_{n=0}^{\infty} B_n$. Then B is simple because it is the direct limit of the simple C^* -algebras B_{2n+1} . From the construction of B_{2n} , it is clear that B is unital and separable, contains the operator space E , has real rank zero, that all nonzero projections in B are Murray-von Neumann equivalent to 1, and that $U(B) \cap U_0(Q) \subset U_0(B)$. The third and fourth properties imply that B is purely infinite and $K_0(B) = 0$. The last property implies that $K_1(B) \rightarrow K_1(Q)$ is injective. But this map is also surjective, since B_0 contains a unitary whose class generates $K_1(Q)$. So $K_1(B) \cong \mathbf{Z}$.

Taking $A = \mathcal{O}_{\infty} \otimes B$ (which has the same K-theory by the Künneth formula [55]), we obtain the statement of the theorem for the special case $G_0 = 0$, $g = 0$, and $G_1 = \mathbf{Z}$. For the general case, choose (by Theorem 4.2.5) a separable nuclear unital purely infinite simple C^* -algebra D satisfying the Universal Coefficient Theorem and such that $K_0(D) \cong G_1$ and $K_1(D) \cong G_0$. (We don't actually need D to be purely infinite here, but it must be in the bootstrap category of [55].) Then $D \otimes B$ is purely infinite and simple, and has the right K-theory by the Künneth formula, except that $[1] = 0$. Choose a projection $p \in D \otimes B$ such that the isomorphism $K_0(D \otimes B) \cong G_0$ sends $[p]$ to g . Then the C^* -algebra $A = \mathcal{O}_{\infty} \otimes p(D \otimes B)p$ satisfies all the conditions of the theorem and contains the given operator space E . □

4.3.12 REMARK. Simplicity and pure infiniteness of $\overline{\bigcup_{n=0}^{\infty} B_n}$ in the proof above can also be arranged by the method of the proof of Proposition 1.3 of [18]. Versions of the construction here have been used many times before.

4.3.13 REMARK. The invariant used here, the set of finite dimensional operator spaces contained in A , does not distinguish between any two separable exact purely infinite simple C^* -algebras. (Any separable exact C^* -algebra embeds in \mathcal{O}_2 by Theorem 2.8 of [29], and \mathcal{O}_2 embeds in any purely infinite simple C^* -algebra.) Therefore, for given K-theory, at most one of the C^* -algebras proved above to be nonisomorphic can be exact.

REFERENCES

- [1] R. G. Bartle and L. M. Graves, *Mappings between function spaces*, Trans. Amer. Math. Soc. 72(1952), 400–413.
- [2] M. Bekka, M. Cowling, and P. de la Harpe, *Some groups whose reduced C^* -algebra is simple*, Inst. Hautes Études Sci. Publ. Math. 80(1994), 117–134.
- [3] B. Blackadar, *Weak expectations and nuclear C^* -algebras*, Indiana Univ. Math. J. 27(1978), 1021–1026.
- [4] B. Blackadar, *Shape theory for C^* -algebras*, Math. Scand. 56(1985), 249–275.
- [5] B. Blackadar, in preparation.
- [6] B. Blackadar, A. Kumjian, and M. Rørdam, *Approximately central matrix units and the structure of noncommutative tori*, K-Theory 6(1992), 267–284.
- [7] O. Bratteli, G. A. Elliott, D. E. Evans, and A. Kishimoto, *On the classification of C^* -algebras of real rank zero III. The infinite case*, pages 11–72 in: *Operator Algebras and their Applications, II (Waterloo, ON, 1994/1995)*, Fields Inst. Commun. vol. 20, Amer. Math. Soc., Providence, RI, 1998.
- [8] O. Bratteli, A. Kishimoto, M. Rørdam, and E. Størmer, *The crossed product of a UHF algebra by a shift*, Ergod. Th. Dynam. Sys. 13(1993), 615–626.
- [9] M.-D. Choi and E. G. Effros, *The completely positive lifting problem for C^* -algebras*, Ann. of Math. (2) 104(1976), 585–609.
- [10] A. Connes, *A factor not anti-isomorphic to itself*, Ann. of Math. (2) 101(1975), 536–554.
- [11] A. Connes and N. Higson, *Déformations, morphismes asymptotiques et K-théorie bivariante*, C. R. Acad. Sci. Paris Sér I Math. 311(1990), 101–106.

- [12] M. Cowling and U. Haagerup, *Completely bounded multipliers of the Fourier algebra of a simple Lie group of real rank one*, Invent. Math. 96(1989), 507–549.
- [13] J. Cuntz, *Simple C^* -algebras generated by isometries*, Comm. Math. Phys. 57(1977), 173–185.
- [14] J. Cuntz, *K -theory for certain C^* -algebras*, Ann. Math. 113(1981), 181–197.
- [15] J. Cuntz, *K -theory and C^* -algebras*, pages 55–79 in: *Algebraic K -Theory, Number Theory, Geometry and Analysis (Bielefeld 1982)*, A. Bak (ed.), Springer Lecture Notes in Math. no. 1046, Springer-Verlag, Berlin, Heidelberg, New York, Tokyo, 1984.
- [16] M. Dădărlat and T. A. Loring, *K -homology, asymptotic representations and unsuspending E -theory*, J. Funct. Anal. 126(1994), 367–383.
- [17] J. de Cannière and U. Haagerup, *Multipliers of the Fourier algebras of some simple Lie groups and their discrete subgroups*, Amer. J. Math. 107(1985), 455–500.
- [18] K. J. Dykema and M. Rørdam, *Purely infinite simple C^* -algebras arising from free product constructions*, Canad. J. Math. 50(1998), 323–341.
- [19] G. A. Elliott, *On the classification of inductive limits of sequences of semisimple finite-dimensional algebras*, J. Algebra 38(1976), 29–44.
- [20] G. A. Elliott, *On the classification of C^* -algebras of real rank zero*, J. reine angew. Math. 443(1993), 179–219.
- [21] G. A. Elliott, *The classification problem for amenable C^* -algebras*, pages 922–932 in: *Proceedings of the International Congress of Mathematicians vol. 2*, Birkhäuser, Basel, Boston, Berlin, 1995.
- [22] G. A. Elliott and M. Rørdam, *Classification of certain infinite simple C^* -algebras II*, Comment. Math. Helv. 70(1995), 615–638.
- [23] U. Haagerup, *Group C^* -algebras without the completely bounded approximation property*, preprint 1988.
- [24] N. Higson, *A characterization of KK -theory*, Pacific J. Math. 126(1987), 253–276.
- [25] M. Junge and G. Pisier, *Bilinear forms on exact operator spaces and $B(H) \otimes B(H)$* , Geometric and Functional Analysis 5(1995), 329–363.
- [26] G. G. Kasparov, *The operator K -functor and extensions of C^* -algebras*, Izv. Akad. Nauk SSSR, Ser. Math. 44(1980), 571–636; English translation in: Math. USSR Izvestija 16(1981), 513–572.

- [27] E. Kirchberg, Lecture at the conference “Algèbres d’Opérateurs”, Genève, 25–30 July 1994.
- [28] E. Kirchberg, *The classification of purely infinite C^* -algebras using Kasparov’s theory*, 3rd draft.
- [29] E. Kirchberg and N. C. Phillips, *Embedding of exact C^* -algebras in the Cuntz algebra \mathcal{O}_2* , J. reine ang. Math., to appear.
- [30] A. Kishimoto, *The Rohlin property for shifts on UHF algebras and automorphisms of Cuntz algebras*, J. Funct. Anal. 140(1996), 100–123.
- [31] A. Kishimoto, *The Rohlin property for automorphisms of UHF algebras*, J. reine angew. Math. 465(1995), 183–196.
- [32] A. Kishimoto and A. Kumjian, *Crossed products of Cuntz algebras by quasi-free automorphisms*, pages 173–192 in: *Operator Algebras and their Applications (Waterloo, ON, 1994/1995)*, Fields Inst. Commun. vol. 13, Amer. Math. Soc., Providence, RI, 1997.
- [33] H. Lin, *Almost commuting unitaries and classification of purely infinite simple C^* -algebras*, J. Funct. Anal. 155(1998), 1–24.
- [34] H. Lin and N. C. Phillips, *Classification of direct limits of even Cuntz-circle algebras*, Memoirs Amer. Math. Soc. no. 565, 1995.
- [35] H. Lin and N. C. Phillips, *Approximate unitary equivalence of homomorphisms from \mathcal{O}_∞* , J. reine angew. Math. 464(1995), 173–186.
- [36] H. Lin and N. C. Phillips, *Almost multiplicative morphisms and the Cuntz algebra \mathcal{O}_2* , International J. Math. 6(1995), 625–643.
- [37] T. A. Loring, *C^* -algebras generated by stable relations*, J. Funct. Anal. 112(1993), 159–203.
- [38] T. A. Loring, *Stable relations II: corona semiprojectivity and dimension-drop C^* -algebras*, Pacific J. Math. 172(1996), 461–475.
- [39] J. Mingo, *K -theory and multipliers of stable C^* -algebras*, Trans. Amer. Math. Soc. 299(1987), 397–411.
- [40] V. Paulsen, *Completely Bounded Maps and Dilations*, Pitman Research Notes in Mathematics Series No. 146, Longman Scientific and Technical, Harlow, Essex, Britain, 1986.
- [41] N. C. Phillips, *Classifying algebras for the K -theory of σ - C^* -algebras*, Canadian J. Math. 41(1989), 1021–1089.
- [42] N. C. Phillips, *Approximation by unitaries with finite spectrum in purely infinite simple C^* -algebras*, J. Funct. Anal. 120(1994), 98–106.

- [43] N. C. Phillips, *How many exponentials?*, Amer. J. Math. 116(1994), 1513–1543.
- [44] N. C. Phillips, *Approximate unitary equivalence of homomorphisms from odd Cuntz algebras*, pages 243–255 in: *Operator Algebras and their Applications (Waterloo, ON, 1994/1995)*, Fields Inst. Commun. vol. 13, Amer. Math. Soc., Providence, RI, 1997.
- [45] N. C. Phillips, *Real rank and exponential length of tensor products with \mathcal{O}_∞* , preprint.
- [46] N. C. Phillips and J. Ringrose, *Exponential rank in operator algebras*, pages 395–413 in: *Current Topics in Operator Algebras*, H. Araki, etc. (eds.), World Scientific, Singapore, New Jersey, London, Hong Kong, 1991.
- [47] J. Ringrose, *Exponential length and exponential rank of C^* -algebras*, Proc. Royal Soc. Edinburgh (Sect. A) 121(1992), 55–71.
- [48] M. Rørdam, *Classification of inductive limits of Cuntz algebras*, J. reine angew. Math. 440(1993), 175–200.
- [49] M. Rørdam, *Classification of Cuntz-Krieger algebras*, K-Theory 9(1995), 31–58.
- [50] M. Rørdam, *A short proof of Elliott's Theorem: $\mathcal{O}_2 \otimes \mathcal{O}_2 \cong \mathcal{O}_2$* , C. R. Math. Rep. Acad. Sci. Canada 16(1994), 31–36.
- [51] M. Rørdam, *Classification of certain infinite simple C^* -algebras*, J. Funct. Anal. 131(1995), 415–458.
- [52] M. Rørdam, *Classification of certain infinite simple C^* -algebras III*, pages 257–282 in: *Operator Algebras and their Applications (Waterloo, ON, 1994/1995)*, Fields Inst. Commun. vol. 13, Amer. Math. Soc., Providence, RI, 1997.
- [53] J. Rosenberg and C. Schochet, *The Künneth theorem and the universal coefficient theorem for Kasparov's generalized K -functor*, Duke Math. J. 55(1987), 431–474.
- [54] J. Samuel, *Asymptotic morphisms and E -theory*, pages 291–314 in: *Operator Algebras and their Applications (Waterloo, ON, 1994/1995)*, Fields Inst. Commun. vol. 13, Amer. Math. Soc., Providence, RI, 1997.
- [55] C. Schochet, *Topological methods for C^* -algebras II: geometric resolutions and the Künneth formula*, Pacific J. Math. 98(1982), 443–458.
- [56] C. Schochet, *Topological methods for C^* -algebras III: axiomatic homology*, Pacific J. Math. 114(1984), 399–445.

- [57] A. M. Sinclair and R. R. Smith, *The Haagerup invariant for von Neumann algebras*, Amer. J. Math. 117(1995), 441–456.
- [58] M. Takesaki, *Theory of Operator Algebras I*, Springer-Verlag, New York, Heidelberg, Berlin, 1979.
- [59] S. Wassermann, *A pathology in the ideal space of $L(H) \otimes L(H)$* , Indiana Univ. Math. J. 27(1978), 1011–1020.
- [60] S. Wassermann, *Exact C^* -Algebras and Related Topics*, Lecture Notes Series No. 19, Research Institute of Mathematics Global Analysis Research Center, Seoul National University, Seoul, Korea, 1994.
- [61] S. Zhang, *Certain C^* -algebras with real rank zero and their corona and multiplier algebras, Part I*, Pacific J. Math. 155(1992) 169–197.
- [62] S. Zhang, *On the exponential rank and exponential length of C^* -algebras*, J. Operator Theory 28(1992), 337–355.

N. Christopher Phillips
Department of Mathematics
University of Oregon
Eugene OR 97403-1222
USA
ncp@darkwing.uoregon.edu

THE INTEGRAL COHOMOLOGY ALGEBRAS OF
ORDERED CONFIGURATION SPACES OF SPHERES

EVA MARIA FEICHTNER AND GÜNTER M. ZIEGLER

Received: August 12, 1999

Communicated by Ulf Rehmann

ABSTRACT. We compute the cohomology algebras of spaces of ordered point configurations on spheres, $F(S^k, n)$, with integer coefficients. For $k = 2$ we describe a product structure that splits $F(S^2, n)$ into well-studied spaces. For $k > 2$ we analyze the spectral sequence associated to a classical fiber map on the configuration space. In both cases we obtain a complete and explicit description of the integer cohomology algebra of $F(S^k, n)$ in terms of generators, relations and linear bases. There is 2-torsion occurring if and only if k is even. We explain this phenomenon by relating it to the Euler classes of spheres.

Our rather classical methods uncover combinatorial structures at the core of the problem.

2000 Mathematics Subject Classification: Primary 55M99; Secondary: 57N65, 55R20, 52C35

Keywords and Phrases: spheres, ordered configuration spaces, subspace arrangements, integral cohomology algebra, fibration, Serre spectral sequence

1 INTRODUCTION

The space of configurations of n pairwise distinct labelled points in a topological space X ,

$$F(X, n) := \{(x_1, \dots, x_n) \in X^n \mid x_i \neq x_j \text{ for } i \neq j\} \subseteq X^n,$$

is called the n -th (ordered) *configuration space* of X .

A systematic study of these spaces started with work by FADELL & NEUWIRTH [FaN] and FADELL [Fa] in the sixties. They introduced sequences of

fibrations for configuration spaces and mainly concentrated on describing their homotopy groups for various instances of X . In 1969 ARNOL'D [Ar] derived the integer cohomology algebra of $F(\mathbb{C}, n)$ — the group cohomology of the colored braid group — and thereby initiated still ongoing research on the cohomology algebras of complements of linear subspace arrangements.

Broader interest in the cohomology algebras of configuration spaces came up in the seventies: The cohomology of $F(X, n)$ for a manifold X appeared as a basic ingredient in the E_2 -terms of spectral sequences for the Gelfand-Fuks cohomology of the manifold [GF] and for the homology of certain function spaces [An]. COHEN [C1, C2] studied various aspects of the cohomology of configuration spaces of Euclidean spaces in view of its relation to homology operations for iterated loop spaces [C3]. COHEN & TAYLOR [CT1, CT2] described the cohomology algebras of configuration spaces of spheres with coefficients in a field of characteristic different from 2. Recently, compactifications of configuration spaces of algebraic varieties have been constructed by FULTON and MACPHERSON [FM]. As an application, they determine the rational homotopy type of configuration spaces of non-singular compact complex algebraic varieties $F(X, n)$ in terms of invariants of X . Compare also work of KRIZ [Kr] and TOTARO [T], where alternative minimal models for $F(X, n)$ are used.

In contrast to these results on the rational homotopy type of configuration spaces, it seems that so far Arnol'd's computation of the integer cohomology algebra of $F(\mathbb{C}, n)$ remained the only instance where the *integer* cohomology algebra of an ordered configuration space was fully described.

Recently, Raoul Bott asked about the integer cohomology algebra of the ordered configuration space of the 2-sphere. We are able to answer his question by describing a product decomposition for $F(S^2, n)$:

$$F(S^2, n) \cong \mathrm{PSL}(2, \mathbb{C}) \times M_{0,n},$$

where $M_{0,n}$, the moduli space of n -punctured complex projective lines, is homotopy equivalent to the complement of an affine complex hyperplane arrangement. We deduce that $H^*(F(S^2, n), \mathbb{Z})$ has (only) 2-torsion that can be traced back to $H^2(\mathrm{PSL}(2, \mathbb{C}), \mathbb{Z}) \cong \mathbb{Z}_2$ (Section 2).

For spheres of higher dimension we use spectral sequences to obtain an analogous decomposition on the level of cohomology algebras:

$$\begin{aligned} H^*(F(S^k, n), \mathbb{Z}) &\cong (\mathbb{Z} \oplus \mathbb{Z}) \otimes H^*(\mathcal{M}(\mathcal{A}_{n-2}^{(k)}), \mathbb{Z}) && \text{for odd } k, \\ H^*(F(S^k, n), \mathbb{Z}) &\cong (\mathbb{Z} \oplus \mathbb{Z}_2 \oplus \mathbb{Z}) \otimes H^*(\mathcal{M}(\mathcal{A}_{\Pi_3}), \mathbb{Z}) && \text{for even } k, \end{aligned}$$

where $\mathcal{M}(\mathcal{A}_{n-2}^{(k)})$ is the complement of a certain arrangement of real linear subspaces $\mathcal{A}_{n-2}^{(k)}$ and $\mathcal{M}(\mathcal{A}_{\Pi_3})$ is the complement of an arrangement of affine subspaces that is naturally related to the linear arrangement $\mathcal{A}_{n-2}^{(k)}$. For both arrangement complements the integer cohomology algebra is torsion-free and we have explicit descriptions in terms of generators, relations and linear bases. *In the following all (co)homology is taken with \mathbb{Z} -coefficients.*

The key for our approach is a family of locally trivial fiber maps on configuration spaces that appears already in the work by FADELL & NEUWIRTH [FaN] and FADELL [Fa]. The maps are given by “projection to the last r points” of a configuration. For configuration spaces of spheres $F(S^k, n)$ and $1 \leq r < n$ the projection Π_r reads as follows:

$$\begin{aligned} \Pi_r = \Pi_r(S^k, n) : \quad F(S^k, n) &\longrightarrow F(S^k, r) \\ (x_1, \dots, x_n) &\longmapsto (x_{n-r+1}, \dots, x_n) . \end{aligned}$$

We derive the integer cohomology algebra of $F(S^k, n)$ for $k > 2$ by a complete discussion of the Leray-Serre spectral sequence associated to the fiber map $\Pi_1(S^k, n)$. Our success with this rather classical approach depends on the fact that the fibers of $\Pi_1(S^k, n)$ are complements of linear subspace arrangements. Their cohomology algebras are well-studied objects both from topological and combinatorial viewpoints [GM, BZ, Bj, DP]. The fibers of $\Pi_1(S^k, n)$ are in fact the complements of codimension k versions of the classical braid arrangements, and thus they are particularly prominent examples of arrangement complements. This paves the way for a complete discussion of the associated spectral sequence (Section 3).

A distinction between the configuration spaces of spheres of odd and even dimension emerges from the only possibly non-trivial differential of the spectral sequence. We present two methods to compute this differential (Section 4).

- (1) It can be derived from one particular cohomology group of $F(S^k, n)$. To obtain the latter we use an independent, rather elementary approach to the cohomology of configuration spaces, which may be of interest on its own right.
- (2) We show that the differential can be interpreted as a map that is induced by “multiplication with the Euler class of S^k .” It is well-known that the Euler class depends on the parity of k .

To get the final tableau of the spectral sequence, and to derive the integer cohomology algebra of the configuration space $F(S^k, n)$, we use combinatorially constructed \mathbb{Z} -linear bases for the cohomology of the fiber (Section 5).

In the last section of this paper we consider the bundle structures on $F(S^k, n)$ given by the fiber maps $\Pi_r(S^k, n)$, $1 < r < n$. We show that the associated spectral sequences collapse in their second terms unless k is even and r equals 1 or 2. For some parameters we can decide the triviality of the bundle structure, which in general is a difficult question.

For configuration spaces of closed manifolds other than spheres, in principle one can attempt to follow the approach taken in this paper. However, with the cohomology of the manifold (i.e., of the base space of the considered fiber map) getting more complicated, the corresponding spectral sequence will be less sparse, and thus more non-trivial differentials will have to be considered. Even more importantly, if the manifold is not simply connected, then it is not straightforward, and not true in general, that the system of local coefficients

on the manifold induced by the fiber map is simple. Already the entries of the second sequence tableau thus will be much harder to compute.

ACKNOWLEDGMENT: We are grateful for discussions with Ezra Getzler that influenced the course of these investigations. Also, we wish to thank Raoul Bott who asked us about connections to the Euler classes of spheres.

2 CONFIGURATION SPACES OF THE 2-SPHERE

We first comment on some special cases for small values of n and on the configuration space of the 1-sphere. For $n = 1$, we see from the definition that $F(X, 1) = X$ for all spaces X . For $n = 2$, we consider the projection Π_1 , sending a configuration in $F(S^k, 2)$ to its second point. We obtain a fiber bundle with contractible fiber $\Pi_1^{-1}(x_2) = F(S^k \setminus \{x_2\}, 1) \cong \mathbb{R}^k$, hence $F(S^k, 2) \simeq S^k$. In fact, $F(S^k, 2)$ is equivalent to the tangent bundle over S^k .

For the configuration space of the 1-sphere, $F(S^1, n)$, we state an explicit trivialization of the fiber bundle given by Π_1 , the projection to the last point of a configuration. Using the group structure on S^1 we define a homeomorphism which shows that $\Pi_1(S^1, n)$ is a trivial fiber map:

$$\begin{aligned} \varphi_1 : F(S^1 \setminus \{e\}, n-1) \times S^1 &\longrightarrow F(S^1, n) \\ ((x_1, \dots, x_{n-1}), y) &\longmapsto (yx_1, \dots, yx_{n-1}, y). \end{aligned}$$

For $r > 1$, the fiber of $\Pi_r(S^1, n)$ is homeomorphic to the space of configurations of $n - r$ points on r disjoint copies of the unit interval. We obtain a homeomorphism

$$\varphi_r : F(\bigsqcup_r (0, 1), n-r) \times F(S^1, r) \longrightarrow F(S^1, n)$$

that trivializes the bundle by “inserting” the points x_1, \dots, x_{n-r} from $\bigsqcup_r (0, 1)$ into the r open segments in which the points of the configuration (y_1, \dots, y_r) in $F(S^1, r)$ separate S^1 .

Compared to configuration spaces of higher dimensional spheres we gain the main structural advantage for the 2-dimensional case from the fact that the 2-sphere S^2 is homeomorphic to the complex projective line $\mathbb{C}P^1$. We will freely switch between the resulting two viewpoints on the configuration space in question.

The group of projective automorphisms $\mathrm{PSL}(2, \mathbb{C})$ of $\mathbb{C}P^1$ acts freely on the configuration space $F(\mathbb{C}P^1, n)$ by coordinatewise action, thus exhibiting $F(\mathbb{C}P^1, n)$ as the total space of a principal $\mathrm{PSL}(2, \mathbb{C})$ -bundle for $n \geq 3$ [Ge]. We identify the base space — the space of n -tuples of distinct points on the complex projective line modulo projective automorphisms — as the moduli space $M_{0,n}$ of n -punctured complex projective lines. Compactifications of $M_{0,n}$ and their cohomology algebras are the focus of recent research; for a brief account and further references see [FM, p.189].

THEOREM 2.1 *The configuration space $F(\mathbb{C}P^1, n)$ of the complex projective line is the total space of a trivial $\mathrm{PSL}(2, \mathbb{C})$ -bundle over $M_{0,n}$ for $n \geq 3$; hence there is a homeomorphism*

$$F(\mathbb{C}P^1, n) \cong \mathrm{PSL}(2, \mathbb{C}) \times M_{0,n}.$$

PROOF. The automorphism group $\mathrm{PSL}(2, \mathbb{C})$ acts sharply 3-transitive on $\mathbb{C}P^1$. In particular, we obtain a homeomorphism between the configuration space of three distinct points on $\mathbb{C}P^1$ and the automorphism group $\mathrm{PSL}(2, \mathbb{C})$:

$$\phi : F(\mathbb{C}P^1, 3) \longrightarrow \mathrm{PSL}(2, \mathbb{C}).$$

Here $(x_1, x_2, x_3) \in F(\mathbb{C}P^1, 3)$ is mapped to the *unique* automorphism that transforms x_1 to $\begin{pmatrix} 1 \\ 0 \end{pmatrix}$, x_2 to $\begin{pmatrix} 0 \\ 1 \end{pmatrix}$, and x_3 to $\begin{pmatrix} 1 \\ 1 \end{pmatrix}$, i.e., to the “standard projective basis” of $\mathbb{C}P^1$.

Given a configuration $x = (x_1, \dots, x_n)$ of n distinct points on $\mathbb{C}P^1$, the group element $\phi(x_1, x_2, x_3)$ transforms x to a configuration on $\mathbb{C}P^1$ that has the standard projective basis in its first three entries. We describe the resulting configuration by the columns of a $(2 \times n)$ -matrix:

$$\phi(x_1, x_2, x_3) \circ x = \begin{pmatrix} 1 & 0 & 1 & z_3 & \dots & z_{n-1} \\ 0 & 1 & 1 & 1 & \dots & 1 \end{pmatrix},$$

where $z_i \in \mathbb{C} \setminus \{0, 1\}$ for $3 \leq i \leq n - 1$, $z_i \neq z_j$ for $3 \leq i < j \leq n - 1$, and the columns are understood as vectors in $\mathbb{C}^2 \setminus \{0\}$ that represent elements in $\mathbb{C}P^1$. Lifting an element $\bar{x} \in M_{0,n}$ to its “normal form” $\phi(x_1, x_2, x_3) \circ x$ in the total space $F(\mathbb{C}P^1, n)$ defines a section for the $\mathrm{PSL}(2, \mathbb{C})$ -bundle. Hence, the principal bundle is trivial [St, Part I, Thm. 8.3]. The resulting product decomposition on $F(\mathbb{C}P^1, n)$ can be described explicitly by the homeomorphism

$$\begin{aligned} \Phi : F(\mathbb{C}P^1, n) &\longrightarrow \mathrm{PSL}(2, \mathbb{C}) \times M_{0,n} \\ (x_1, \dots, x_n) &\longmapsto (\phi(x_1, x_2, x_3), \bar{x}). \end{aligned} \quad \square$$

REMARK 2.2 An analogous argument is not possible for S^4 , since there are no *sharply* 3-transitive group actions in the case of a non-commutative field such as \mathbb{H} . The structural reason for this can be traced back to a theorem by VON STAUDT, see [P, Kap. 5.1.4].

In view of a description of the integer cohomology algebra of $F(\mathbb{C}P^1, n)$ we use the intimate relation of the base space $M_{0,n}$ to a complex hyperplane arrangement — the *complex braid arrangement* $\mathcal{A}_{n-2}^{\mathbb{C}}$ of rank $n - 2$ in \mathbb{C}^{n-1} given by the hyperplanes

$$z_j - z_i = 0 \quad \text{for } 1 \leq i < j \leq n - 1.$$

This arrangement is a key example in the theory of hyperplane arrangements and initiated much of its development [Ar, OT]. Its complement, $\mathcal{M}(\mathcal{A}_{n-2}^{\mathbb{C}}) := \mathbb{C}^{n-1} \setminus \bigcup \mathcal{A}_{n-2}^{\mathbb{C}}$, coincides with $F(\mathbb{C}, n - 1)$, the configuration space of the complex plane.

The base space $M_{0,n}$ is homotopy equivalent to the complement of the affine arrangement $\text{aff}\mathcal{A}_{n-2}^{\mathbb{C}}$, which is obtained from $\mathcal{A}_{n-2}^{\mathbb{C}}$ by restriction to the affine hyperplane $\{z_2 - z_1 = 1\} \cong \mathbb{C}^{n-2}$. A complete description of the integer cohomology algebra of the complement $\mathcal{M}(\text{aff}\mathcal{A}_{n-2}^{\mathbb{C}}) := \mathbb{C}^{n-2} \setminus \bigcup \text{aff}\mathcal{A}_{n-2}^{\mathbb{C}}$ is provided by general theory on the topology of complex hyperplane arrangements [OS, BZ, OT]. The description depends only on combinatorial data of the arrangement, i.e., on the semi-lattice of intersections $\mathcal{L}(\text{aff}\mathcal{A}_{n-2}^{\mathbb{C}})$ which is customarily ordered by reverse inclusion.

PROPOSITION 2.3 *The base space $M_{0,n}$ is homotopy equivalent to the complement of the affine complex braid arrangement of rank $n - 2$, since*

$$M_{0,n} \times \mathbb{C} \cong \mathcal{M}(\text{aff}\mathcal{A}_{n-2}^{\mathbb{C}}).$$

Its integer cohomology algebra is torsion-free. It is generated by one-dimensional classes $e_{i,j}$ for $1 \leq i < j \leq n - 1$, $(i, j) \neq (1, 2)$, and has a presentation as a quotient of the exterior algebra on these generators:

$$H^*(\mathcal{M}(\text{aff}\mathcal{A}_{n-2}^{\mathbb{C}})) \cong \Lambda^* \mathbb{Z}^{\binom{n-1}{2}-1} / I,$$

where I is the ideal generated by elements of the form

$$\begin{aligned} e_{i,l} \wedge e_{j,l} - e_{i,j} \wedge e_{j,l} + e_{i,j} \wedge e_{i,l} & \text{ for } 1 \leq i < j < l \leq n - 1, (i, j) \neq (1, 2), \\ e_{1,i} \wedge e_{2,i} & \text{ for } 2 < i \leq n - 1. \end{aligned}$$

PROOF. We consider the homeomorphic image of $M_{0,n}$ under the section defined in the proof of Proposition 2.1:

$$\begin{aligned} M_{0,n} & \cong \left\{ \left(\begin{array}{cccccc} 1 & 0 & 1 & z_3 & \dots & z_{n-1} \\ 0 & 1 & 1 & 1 & \dots & 1 \end{array} \right) \mid z_i \in \mathbb{C} \setminus \{0, 1\}, z_i \neq z_j \text{ for } i \neq j \right\} \\ & \cong \{ (z_1, \dots, z_{n-1}) \mid z_i \in \mathbb{C}, z_i \neq z_j \text{ for } i \neq j, z_1 = 0, z_2 - z_1 = 1 \}. \end{aligned}$$

From this description we see that $M_{0,n}$ is homeomorphic to the complement of the affine braid arrangement $\text{aff}\mathcal{A}_{n-2}^{\mathbb{C}}$ intersected with the hyperplane $\{z_1 = 0\}$. This intersection operation is equivalent to a projection parallel to the intersection of all the hyperplanes in $\mathcal{A}_{n-2}^{\mathbb{C}}$, $\bigcap \mathcal{A}_{n-2}^{\mathbb{C}} = \{z_1 = \dots = z_{n-1}\}$. The fibers of this projection map are contractible: they are translates of $\bigcap \mathcal{A}_{n-2}^{\mathbb{C}}$. Hence the projection does not alter the homotopy type, and we conclude that $M_{0,n}$ is homotopy equivalent to $\mathcal{M}(\text{aff}\mathcal{A}_{n-2}^{\mathbb{C}})$.

The presentation of the integer cohomology algebra follows from general results on the topology of the complements of complex hyperplane arrangements (compare [OT]). \square

We have seen that the fiber $\text{PSL}(2, \mathbb{C})$ is homeomorphic to $F(\mathbb{C}P^1, 3)$, resp. $F(S^2, 3)$. By a result of FADELL [Fa, Thm. 2.4] there is a fiber homotopy

equivalence between $F(S^k, 3)$ and $V_{k+1,2}$, the Stiefel manifold of orthogonal 2-frames in \mathbb{R}^{k+1} . The cohomology of the latter is well-known, see [Bd, Ch. IV, Exp. 13.5].

Combining the product structure on $F(\mathbb{C}P^1, n)$ obtained in Theorem 2.1 with the information on the cohomology algebras of base space and fiber we conclude:

THEOREM 2.4 *The cohomology algebra of $F(S^2, n)$ with integer coefficients is given by*

$$\begin{aligned} H^*(F(S^2, n)) &\cong H^*(F(S^2, 3)) \otimes H^*(\mathcal{M}(\text{aff}\mathcal{A}_{n-2}^C)) \\ &\cong (\mathbb{Z}(0) \oplus \mathbb{Z}(2) \oplus \mathbb{Z}(3)) \otimes \Lambda^* \bigoplus_{\binom{n-1}{2}-1} \mathbb{Z}(1) / I, \end{aligned}$$

where $G(i)$ denotes a direct summand G in dimension i , and I is the ideal of relations described in Proposition 2.3.

3 A SPECTRAL SEQUENCE FOR $H^*(F(S^k, n))$

Our approach for $k > 2$ uses the Leray-Serre spectral sequence associated with the projection Π_1 :

$$\begin{aligned} \Pi_1 : \quad F(S^k, n) &\longrightarrow S^k \\ (x_1, \dots, x_n) &\longmapsto x_n. \end{aligned}$$

For the construction and special features of Leray-Serre spectral sequences we refer to BOREL [Bo2, Sect. 2]. Since the base space of the considered fiber bundle is a sphere we could equally work with the Wang sequence [Wh, Ch. VII, Sect. 3], a long exact sequence connecting the cohomology of the total space and of the fiber. However, the derivation of the multiplicative structure of the cohomology algebra gets more transparent with spectral sequence tableaux. Moreover, this approach extends to projections Π_r for $r > 1$ (see Section 6).

We meet especially favorable conditions in the second tableau of the Leray-Serre spectral sequence associated to the fiber map $\Pi_1(S^k, n)$: The base space S^k is simply connected for $k \geq 2$, hence the system of local coefficients on S^k induced by Π_1 for $k \geq 2$ is simple. As the fiber over $x_n \in S^k$ we obtain:

$$\begin{aligned} \Pi_1^{-1}(x_n) &= \{(x_1, \dots, x_{n-1}) \in (S^k)^{n-1} \mid x_i \neq x_j \text{ for } i \neq j, \\ &\qquad\qquad\qquad x_i \neq x_n \text{ for } i = 1, \dots, n-1\} \\ &\cong \{(x_1, \dots, x_{n-1}) \in (\mathbb{R}^k)^{n-1} \mid x_i \neq x_j \text{ for } i \neq j\}. \end{aligned}$$

This is the complement of the *real k -braid arrangement* $\mathcal{A}_{n-2}^{(k)}$ of rank $n-2$ which is formed by linear subspaces $U_{i,j}$ in $(\mathbb{R}^k)^{n-1}$, $1 \leq i < j \leq n-1$,

$$U_{i,j} = \{(x_1, \dots, x_{n-1}) \in (\mathbb{R}^k)^{n-1} \mid x_{i_1} = x_{j_1}, \dots, x_{i_k} = x_{j_k}\}.$$

This arrangement, a direct generalization of the real and complex braid arrangements, is a k -arrangement in the sense of GORESKEY & MACPHERSON [GM, Part III, p. 239]: the subspaces have codimension k , and the codimensions of their intersections are multiples of k . Such arrangements have combinatorial properties analogous to those of complex hyperplane arrangements, which is reflected by strong similarities in their topological properties: The cohomology algebras of real k -arrangements are torsion-free [GM, Part III, Thm. B]; they are generated in dimension $k - 1$ by cohomology classes that naturally correspond to the subspaces of the arrangement [BZ, Sect. 9].

The complement of the real k -braid arrangement $\mathcal{A}_{n-2}^{(k)}$ is an ordered configuration space: the space $F(\mathbb{R}^k, n - 1)$ of configurations of $n - 1$ pairwise distinct points in \mathbb{R}^k . The following thus complements work by COHEN [C1, C2], who discussed the cohomology of $F(\mathbb{R}^k, n - 1)$ in connection with homology operations for iterated loop spaces.

PROPOSITION 3.1 *The integer cohomology algebra of $\mathcal{M}(\mathcal{A}_{n-2}^{(k)})$ is generated by $(k - 1)$ -dimensional cohomology classes $c_{i,j}$, $1 \leq i < j \leq n - 1$. It has a presentation as a quotient of the exterior algebra on these generators:*

$$H^*(\mathcal{M}(\mathcal{A}_{n-2}^{(k)})) \cong \Lambda^* \mathbb{Z}^{\binom{n-1}{2}} / I,$$

where I is the ideal generated by the elements

$$(c_{i,l} \wedge c_{j,l}) + (-1)^{k+1} (c_{i,j} \wedge c_{j,l}) + (c_{i,j} \wedge c_{i,l}) \quad \text{for } 1 \leq i < j < l \leq n - 1.$$

REMARK 3.2 The generating cohomology classes $c_{i,j}$, $1 \leq i < j \leq n - 1$, are defined by restricting cohomology generators $\widehat{c}_{i,j}$ for the subspace complements $\mathcal{M}(\{U_{i,j}\}) \simeq S^{k-1}$ to the complement of the arrangement. A canonical choice of the generators $\widehat{c}_{i,j}$ results from fixing the natural “frame of hyperplanes” in the sense of [BZ, Sect. 9].

PROOF. BJÖRNER & ZIEGLER [BZ, Sect. 9] derived a presentation for the cohomology algebras of real k -arrangements up to the signs in the relations. For the real k -braid arrangement their presentation specializes up to signs to the one stated above.

Consider the relation for a triple $1 \leq i < j < l \leq n - 1$:

$$\varepsilon_1(c_{i,l} \wedge c_{j,l}) + \varepsilon_2(c_{i,j} \wedge c_{j,l}) + \varepsilon_3(c_{i,j} \wedge c_{i,l}) = 0, \quad \varepsilon_r \in \{\pm 1\} \quad \text{for } r = 1, 2, 3.$$

Transpositions of (i, j) and (i, l) and of (i, l) and (j, l) in the linear (lexicographic) order of the subspaces in $\mathcal{A}_{n-2}^{(k)}$ lead to similar relations among the cohomology classes $c_{i,l} \wedge c_{j,l}$, $c_{i,j} \wedge c_{j,l}$, and $c_{i,j} \wedge c_{i,l}$:

$$\begin{aligned} \varepsilon_1(c_{i,j} \wedge c_{j,l}) + \varepsilon_2(c_{i,l} \wedge c_{j,l}) + \varepsilon_3(c_{i,l} \wedge c_{i,j}) &= 0 \\ \varepsilon_1(c_{j,l} \wedge c_{i,l}) + \varepsilon_2(c_{i,j} \wedge c_{i,l}) + \varepsilon_3(c_{i,j} \wedge c_{j,l}) &= 0. \end{aligned}$$

Anti-commutativity of the exterior product yields the signs in the relations. \square

We obtain the following tensor product decomposition on the E^2 -tableau of the Leray-Serre spectral sequence associated with the fiber map $\Pi_1(S^k, n)$:

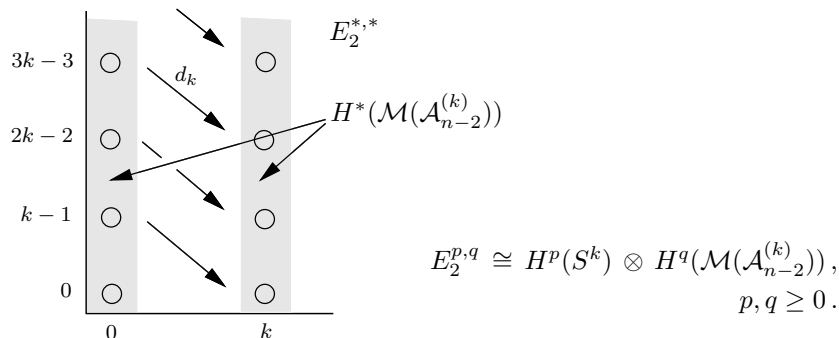

The location of non-zero entries shows that there is only one possibly non-trivial differential on stage k of the sequence.

4 THE k -TH DIFFERENTIAL

The tableaux of a cohomological spectral sequence are bigraded algebras. The differentials respect their multiplicative structure. In particular, the differentials are determined by their action on multiplicative generators of the sequence tableaux. Thus, it suffices in our case to describe d_k on the multiplicative generators $c_{i,j}$, $1 \leq i < j \leq n - 1$, of $E_k^{0,*} \cong H^*(\mathcal{M}(\mathcal{A}_{n-2}^{(k)}))$ in dimension $k - 1$.

Actually, we can restrict our attention even further to the action of d_k on one single generator, say on $c_{1,2}$: The permutation of the first $n - 1$ points of a configuration in $F(S^k, n)$ by \mathfrak{S}_{n-1} gives a group action on the considered fiber bundle and hence induces a \mathfrak{S}_{n-1} -action on the spectral sequence. The group \mathfrak{S}_{n-1} acts transitively on the generators $c_{i,j}$ of $E_k^{0,k-1}$, whereas it keeps $E_k^{k,0}$ fixed. We conclude that

$$d_k(c_{i,j}) = d_k(c_{1,2}) \quad \text{for } 1 \leq i < j \leq n - 1.$$

In the following we provide two independent ways to evaluate d_k .

4.1 . . . VIA A HOMOLOGY GROUP OF THE DISCRIMINANT.

Here the key observation is that knowing $H^k(F(S^k, n))$ is sufficient to determine d_k . To obtain this specific group, we use a ‘‘Vassiliev type’’ argument that allows one to compute, in favorable situations, some cohomology groups of configuration spaces. Using a smooth compactification, in our case given by $F(S^k, n) \subseteq (S^k)^n$, we set

$$F(S^k, n) = (S^k)^n \setminus \Gamma_n = (S^k)^n \setminus \bigcup_{1 \leq i < j \leq n} (\Gamma_n)_{i,j},$$

where

$$(\Gamma_n)_{i,j} = \{(x_1, \dots, x_n) \in (S^k)^n \mid x_i = x_j\} \quad \text{for } 1 \leq i < j \leq n.$$

The idea is to use duality theorems in $(S^k)^n$ for transferring homology information about the *discriminant* Γ_n to the cohomology of $F(S^k, n)$. For this, we proceed in three steps.

STEP 1. Determine $H_*(\Gamma_n)$ in dimensions $(n-1)k$ and $(n-1)k-1$.

The spaces $(\Gamma_n)_{i,j}$ are homeomorphic to $(S^k)^{n-1}$; they intersect in spaces homeomorphic to $(S^k)^{n-2}$, hence in dimension $k(n-2)$. By a Mayer-Vietoris argument we obtain the top two homology groups of the discriminant:

$$\begin{aligned} H_{(n-1)k}(\Gamma_n) &\cong \bigoplus_{1 \leq i < j \leq n} H_{(n-1)k}((\Gamma_n)_{i,j}) \cong \mathbb{Z}^{\binom{n}{2}} \\ H_{(n-1)k-1}(\Gamma_n) &= 0. \end{aligned}$$

STEP 2. Determine the relative homology $H_*((S^k)^n, \Gamma_n)$ in dimension $(n-1)k$. The relevant part of the long exact sequence in homology for the pair $((S^k)^n, \Gamma_n)$ is the following:

$$\rightarrow H_{(n-1)k}(\Gamma_n) \xrightarrow{i_*} H_{(n-1)k}((S^k)^n) \rightarrow H_{(n-1)k}((S^k)^n, \Gamma_n) \rightarrow H_{(n-1)k-1}(\Gamma_n) \rightarrow$$

We had computed that the last group is zero, and thus

$$H_{(n-1)k}((S^k)^n, \Gamma_n) \cong \text{coker } i_*,$$

where i_* is induced by the inclusion $i: \Gamma_n \hookrightarrow (S^k)^n$. We intend to write i_* as a $(n \times \binom{n}{2})$ -matrix over \mathbb{Z} and to read the cokernel from its Smith normal form [Mu, § 11]. For this we choose \mathbb{Z} -bases for the homology groups that are involved, and determine i_* in terms of these bases.

According to the Künneth Theorem, $H_{(n-1)k}((S^k)^n)$ has a basis that consists of tensor products of k -dimensional classes ω_j , $j = 1, \dots, n$, of the form

$$\nu_i = \omega_1 \otimes \dots \otimes \widehat{\omega}_i \otimes \dots \otimes \omega_n, \quad i = 1, \dots, n,$$

where ω_j is an orientation class for the j -th factor in $(S^k)^n$, and $\widehat{\omega}_i$ denotes that we omit the i -th class.

Generating homology classes of Γ_n in dimension $(n-1)k$ are given by the $\binom{n}{2}$ generating homology classes for the spaces $(\Gamma_n)_{i,j}$, $1 \leq i < j \leq n$. These spaces are products of k -spheres,

$$(\Gamma_n)_{i,j} \cong S_{i,j} \times S_1 \times \dots \times \widehat{S}_i \times \dots \times \widehat{S}_j \times \dots \times S_n,$$

with S_l denoting the l -th k -sphere appearing as a factor in $(S^k)^n$, whereas $S_{i,j}$ denotes the k -sphere diagonally embedded in the i -th and j -th k -sphere. A generating homology class for $(\Gamma_n)_{i,j}$ in dimension $(n-1)k$ can be described as

$$\nu_{ij} = \omega_{ij} \otimes \omega_1 \otimes \dots \otimes \widehat{\omega}_i \otimes \dots \otimes \widehat{\omega}_j \otimes \dots \otimes \omega_n, \quad 1 \leq i < j \leq n,$$

where ω_{ij} is a homology generator for $S_{i,j}$ in dimension k .

To understand how i_* maps such generators ν_{ij} we use the following lemma. It tells how to describe the homology generator of the diagonal in $S_i \times S_j$ in terms of homology classes of the product.

LEMMA 4.1 *Let ω denote a generating homology class in dimension k for the k -sphere. Under the diagonal map $\Delta : S^k \rightarrow S^k \times S^k$, $\Delta(x) = (x, x)$ for $x \in S^k$, the homology class ω is mapped to*

$$\Delta_*(\omega) = \omega \otimes 1 + 1 \otimes \omega.$$

PROOF. By the Künneth Theorem the two summands form a basis of $H_k(S^k \times S^k)$, so $\Delta_*(\omega)$ is a \mathbb{Z} -linear combination of those. Moreover, the diagonal map combined with one of the projections pr_i to the respective factor is the identity map on S^k . Hence the result follows from $(\text{pr}_i)_* \circ \Delta_*(\omega) = \omega$ for $i = 1, 2$. \square

We conclude that

$$i_*(\nu_{ij}) = ((\omega_i \otimes 1) + (1 \otimes \omega_j)) \otimes \bigotimes_{\substack{l=1 \\ l \neq i, j}}^n \omega_l, \quad 1 \leq i < j \leq n.$$

To write this in terms of the generators ν_i for $H_{(n-1)k}((S^k)^n)$ we have to permute the factors of the underlying product space to the order used above in the definition of the classes ν_i . The tensor product of homology classes is anti-commutative [FFG, Ch. II, §16]; i.e., under the transposition map $\tau : X \times X \rightarrow X \times X$, $(x_1, x_2) \mapsto (x_2, x_1)$, a product of homology classes $\alpha \otimes \beta$, $\alpha, \beta \in H_*(X)$, is mapped to

$$\tau_*(\alpha \otimes \beta) = (-1)^{\text{deg}(\alpha)\text{deg}(\beta)} \beta \otimes \alpha.$$

This is the point where the distinction between odd and even dimensions comes up:

$$i_*(\nu_{ij}) = \begin{cases} (-1)^{i-1}\nu_j + (-1)^{j-2}\nu_i & \text{for odd } k, \\ \nu_j + \nu_i & \text{for even } k \end{cases} \quad (1 \leq i < j \leq n).$$

Writing i_* as a $(n \times \binom{n}{2})$ -matrix $M(n)$ we obtain the (unsigned) incidence matrix of 2-element subsets of an n -set for even k , whereas for odd k a certain sign pattern occurs on the matrix entries. For example,

$$M(3) = \begin{matrix} & \begin{matrix} 12 & 13 & 23 \end{matrix} \\ \begin{matrix} 1 \\ 2 \\ 3 \end{matrix} & \begin{pmatrix} 1 & (-1)^k & 0 \\ 1 & 0 & (-1)^k \\ 0 & 1 & (-1)^k \end{pmatrix} \end{matrix},$$

$$M(4) = \begin{matrix} & \begin{matrix} 12 & 13 & 14 & 23 & 24 & 34 \end{matrix} \\ \begin{matrix} 1 \\ 2 \\ 3 \\ 4 \end{matrix} & \begin{pmatrix} 1 & (-1)^k & 1 & 0 & 0 & 0 \\ 1 & 0 & 0 & (-1)^k & 1 & 0 \\ 0 & 1 & 0 & (-1)^k & 0 & 1 \\ 0 & 0 & 1 & 0 & (-1)^k & 1 \end{pmatrix} \end{matrix}.$$

We now derive the Smith normal forms of the matrices $M(n)$ by describing elementary row and column operations. Ordering the columns of $M(n)$ – corresponding to the 2-element subsets of $\{1, \dots, n\}$ – lexicographically, we see that

$$M(n) = \left(\begin{array}{cccc|cccc} 1 & \dots & \dots & 1 & 0 & \dots & \dots & 0 \\ 1 & & & & & & & \\ & \ddots & & & & & & \\ & & \ddots & & & & & \\ & & & 1 & & & & \\ & & & & & & & \end{array} \right) \text{ for even } k, \text{ and}$$

$$M(n) = \left(\begin{array}{cccc|cccc} 1 & -1 & \dots & (-1)^n & 0 & \dots & \dots & 0 \\ 1 & & & & & & & \\ & \ddots & & & & & & \\ & & \ddots & & & & & \\ & & & 1 & & & & \\ & & & & & & & \end{array} \right) \text{ for odd } k.$$

For even k , we subtract the i -th row from the first row for $i = 2, \dots, n$, and thus create 0-entries in the left part of the first row and entries -2 on top of the submatrix $M(n-1)$. Note that the column sum in $M(n-1)$ is 2. Adding multiples of the first $n-1$ columns to the rest of the matrix, we transform $M(n-1)$ to 0. The remaining entries in the first row can be reduced to one single entry 2, and after switching rows and columns we obtain the following Smith normal form:

$$\text{SNF}(M(n)) = \left(\begin{array}{cccc|c} 1 & & & & 0 \\ & \ddots & & & \\ & & 1 & & \\ & & & 2 & \end{array} \right) \text{ for even } k.$$

For odd k , we add the t -th row multiplied with $(-1)^{t-1}$ to the first row for $i = 2, \dots, n$. This creates 0-entries in the first row. This is obvious for the first $n-1$ columns. For an entry on top of a column of the submatrix $-M(n-1)$ which contains entries in its i -th and j -th rows, we obtain

$$(-1)^i \cdot (-(-1)^{j-2}) + (-1)^j \cdot (-(-1)^{i-1}) = 0.$$

As before, we transform the submatrix $-M(n-1)$ to 0 by adding multiples of the first $n-1$ columns. Thus, after switching rows, we obtain:

$$\text{SNF}(M(n)) = \left(\begin{array}{cccc|c} 1 & & & & 0 \\ & \ddots & & & \\ & & 1 & & \\ & & & 0 & \end{array} \right) \text{ for odd } k.$$

We read off the cokernel of i_* as

$$H_{(n-1)k}((S^k)^n, \Gamma_n) \cong \begin{cases} \mathbb{Z} & \text{for odd } k, \\ \mathbb{Z}_2 & \text{for even } k. \end{cases}$$

STEP 3. Apply Poincaré-Lefschetz duality between relative homology of the pair $((S^k)^n, \Gamma_n)$ and cohomology of $F(S^k, n)$.

PROPOSITION 4.2 *The k -th cohomology group of $F(S^k, n)$, $k > 2$, $n > 2$, is given by*

$$H^k(F(S^k, n)) \cong \begin{cases} \mathbb{Z} & \text{for odd } k, \\ \mathbb{Z}_2 & \text{for even } k. \end{cases}$$

REMARK 4.3 In principle, the discriminant approach can be used to determine the cohomology of $F(S^k, n)$ as a graded group. However, to compute $H_*(\Gamma_n)$ is difficult and requires extra tools (interpretation of Γ_n as a homotopy limit of a diagram of spaces, study of a spectral sequence converging to the homology of a homotopy limit [ZŽ, Sect. 3(e)]). Also, the study of the pair sequence gets considerably more involved. Moreover, because of the use of Poincaré-Lefschetz duality the multiplicative structure of $H^*(F(S^k, n))$ seems out of reach for this approach.

The partial result of Proposition 4.2 allows us to determine the differential in the spectral sequence associated to $\Pi_1(S^k, n)$. Taking cohomology of $E_k^{*,*}$ with respect to the differential d_k leads to the *final* sequence tableau $E_{k+1}^{*,*}$:

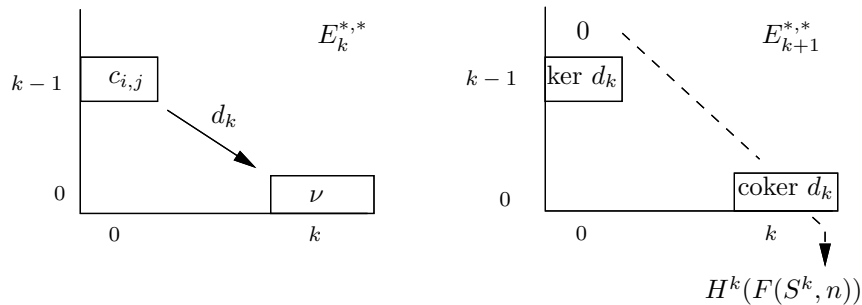

Since there is only one non-zero entry on the k -th diagonal for $k > 2$, $H^k(F(S^k, n))$ can be read from $E_{k+1}^{*,*}$:

$$H^k(F(S^k, n)) \cong \text{coker } d_k.$$

Our result on $H^k(F(S^k, n))$ in Proposition 4.2 implies that

$$d_k(c_{1,2}) = d_k(c_{i,j}) = \begin{cases} 0 & \text{for odd } k \\ 2\nu & \text{for even } k, \end{cases}$$

where ν is a generator of $H^k(S^k)$.

4.2 ... VIA AN INTERPRETATION IN TERMS OF THE EULER CLASS.

Our second approach to the differential d_k stays within the setting of fiber bundles. We study an inclusion of fiber bundles and transfer information on the differentials via the induced homomorphism of spectral sequences. We will find that the differential is determined by the Euler class of the base space S^k , which depends on the parity of k .

Consider, for $n \geq 3$, the following space of point configurations on S^k , $k > 2$:

$$\widehat{F} := \{(x_1, \dots, x_n) \in (S^k)^n \mid x_1 \neq x_2, x_j \neq x_n \text{ for } j = 1, \dots, n-1\}.$$

Projection of a configuration to its last point, $\widehat{\Pi} : \widehat{F} \rightarrow S^k$, makes it the total space of a fiber bundle with spherical fiber: the complement of the codimension k subspace $U_{1,2}$ in $(\mathbb{R}^k)^{n-1}$,

$$\begin{aligned} \widehat{\Pi}^{-1}(x_n) &= \{(x_1, \dots, x_{n-1}) \in (S^k)^{n-1} \mid x_1 \neq x_2, x_j \neq x_n \text{ for } 1 \leq j \leq n-1\} \\ &\cong \{(x_1, \dots, x_{n-1}) \in (\mathbb{R}^k)^{n-1} \mid x_1 \neq x_2\} \\ &= \mathcal{M}(\{U_{1,2}\}). \end{aligned}$$

The spectral sequence \widehat{E}_* associated to $\widehat{\Pi}$ has an \widehat{E}_2 -tableau of the form

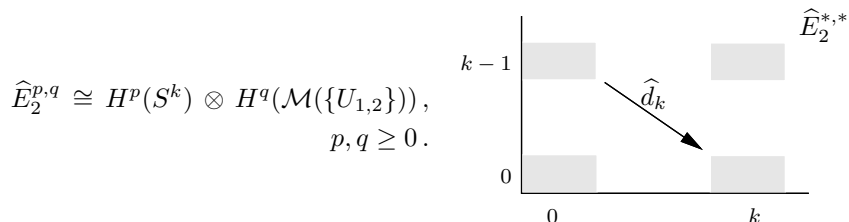

$$\widehat{E}_2^{p,q} \cong H^p(S^k) \otimes H^q(\mathcal{M}(\{U_{1,2}\})), \quad p, q \geq 0.$$

From the location of non-zero entries in $\widehat{E}_2^{*,*}$ we easily see that there is only one possibly non-trivial differential \widehat{d}_k on stage k of the sequence. The inclusion of $F(S^k, n)$ into \widehat{F} is a map of fiber bundles.

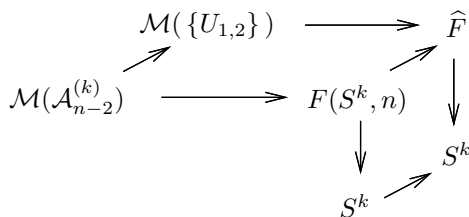

The homomorphism of spectral sequences induced by the inclusion of the fiber bundles factors on the \widehat{E}_k -tableau into the induced map between the cohomology of the fibers and the identity on the cohomology of the base space [Bo1, Exp. VIII, Thm. 4]. The map i^* between the cohomology of the fibers maps

the generator $\widehat{c}_{1,2}$ of $H^{k-1}(\mathcal{M}(\{U_{1,2}\}))$ to $c_{1,2}$ in $H^{k-1}(\mathcal{M}(\mathcal{A}_{n-2}^{(k)}))$ (compare Remark 3.2). Hence, we are left to determine the action of the k -th differential on $\widehat{E}_k^{0,k-1}$:

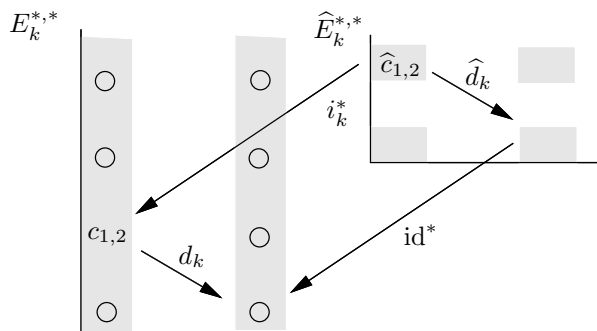

$$d_k(c_{1,2}) = d_k(i_k^*(\widehat{c}_{1,2})) = \widehat{d}_k(\widehat{c}_{1,2}).$$

PROPOSITION 4.4 *The fiber bundle \widehat{F} over S^k is fiber homotopy equivalent to $V_{k+1,2}$, the Stiefel manifold of orthogonal 2-frames in \mathbb{R}^{k+1} , considered as fiber bundle over S^k .*

PROOF. \widehat{F} is fiber homotopy equivalent to $F(S^k, 3)$, both spaces considered as fiber bundles over S^k . The fiber homotopy equivalence is realized by the projection of configurations in \widehat{F} to their first, second and last points. In turn, $F(S^k, 3)$ is fiber homotopy equivalent to the Stiefel manifold $V_{k+1,2}$ [Fa, Thm. 2.4]. \square

For a simply connected, k -dimensional, orientable manifold M the only possibly non-trivial differential in the spectral sequence associated to the unit tangent bundle can be described as a cup product multiplication with the Euler class of the manifold:

$$d_k(x \otimes \mu) = d_k(\mu) \smile x = \chi_M \smile x,$$

where μ is a generator of $H^{k-1}(S^{k-1})$, $x \in H^*(M)$, and χ_M denotes the Euler class of the manifold (compare [MS, Thm. 12.2]).

The Stiefel manifold $V_{k+1,2}$ coincides with the unit tangent bundle on S^k . Given an orientation on S^k and a generator ν of $H^k(S^k)$ that evaluates to 1 on the orientation class, the Euler class of S^k is given by

$$\chi_{S^k} = \begin{cases} 0 & \text{for odd } k, \\ 2\nu & \text{for even } k. \end{cases}$$

We conclude that in the spectral sequence for \widehat{F} the differential \widehat{d}_k maps the generator $\widehat{c}_{1,2}$ of $H^{k-1}(\mathcal{M}(\{U_{1,2}\}))$ to the Euler class χ of the base space, once an orientation for the base S^k and with it the Euler class have been chosen

appropriately. In particular, \widehat{d}_k is the zero-map for odd k . For our initial fiber bundle we thus derive

$$d_k(c_{i,j}) = d_k(c_{1,2}) = \begin{cases} 0 & \text{for odd } k, \\ 2\nu & \text{for even } k, \end{cases}$$

where 2ν is the Euler class of the k -sphere under appropriate orientation.

5 RECOVERING $H^*(F(S^k, n))$ FROM THE SPECTRAL SEQUENCE

For configuration spaces of odd-dimensional spheres we now have enough information to derive a complete description of the integer cohomology algebra. In the previous section we showed that the k -th differential is trivial on multiplicative generators of the sequence tableau $E_k^{*,*}$, therefore it is trivial on all of $E_k^{*,*}$. The spectral sequence collapses in its second term; a favorable location of non-zero tableau entries allows us to get both the linear and the multiplicative structure of $H^*(F(S^k, n))$ directly from the second tableau:

THEOREM 5.1 *For a sphere S^k of odd dimension $k \geq 3$, and $n \geq 3$, the integer cohomology algebra of $F(S^k, n)$ is given by*

$$\begin{aligned} H^*(F(S^k, n)) &\cong H^*(S^k) \otimes H^*(\mathcal{M}(\mathcal{A}_{n-2}^{(k)})) \\ &\cong (\mathbb{Z}(0) \oplus \mathbb{Z}(k)) \otimes \Lambda^* \bigoplus_{\binom{n-1}{2}} \mathbb{Z}(k-1) / I, \end{aligned}$$

where I is the ideal described in Proposition 3.1. In particular, the cohomology is free.

For the case of even-dimensional spheres the considerations in the previous section show that the k -th differential is non-zero. We have to describe the kernel and cokernel of that differential and with it the final sequence tableau $E_{k+1}^{*,*}$ in a manageable form.

The cohomology algebra of the fiber, hence of the left-most column of the second, resp. k -th tableau, is given by Proposition 3.1. A linear basis for this algebra is given by the products of $(k-1)$ -dimensional classes $c_{i,j}$ associated with the faces of the broken circuit complex $\text{BC}(\mathcal{L})$ of the intersection lattice $\mathcal{L} = \mathcal{L}(\mathcal{A}_{n-2}^{(k)})$ [BZ, Sect. 9]:

$$\mathcal{B}_{BC} = \{c_{\alpha_1} \wedge \dots \wedge c_{\alpha_t} \mid \{\alpha_1, \dots, \alpha_t\} \in \text{BC}(\mathcal{L})\}.$$

Here is a different basis which enables us to describe the kernel of d_k both as a direct summand and as a subalgebra of $H^*(\mathcal{M}(\mathcal{A}_{n-2}^{(k)}))$:

PROPOSITION 5.2 *The following set is a \mathbb{Z} -linear basis for $H^*(\mathcal{M}(\mathcal{A}_{n-2}^{(k)}))$:*

$$\begin{aligned} \mathcal{B}' &= \{c_{1,2} \wedge (c_{\alpha_1} - c_{1,2}) \wedge \dots \wedge (c_{\alpha_t} - c_{1,2}) \mid \{\alpha_1, \dots, \alpha_t\} \in \text{BC}(\mathcal{L}), \alpha_i \neq (1,2)\} \\ &\cup \{(c_{\alpha_1} - c_{1,2}) \wedge \dots \wedge (c_{\alpha_t} - c_{1,2}) \mid \{\alpha_1, \dots, \alpha_t\} \in \text{BC}(\mathcal{L}), \alpha_i \neq (1,2)\}. \end{aligned}$$

PROOF. Each element in \mathcal{B}_{BC} can be written as a linear combination of elements in \mathcal{B}' . This is true for each element having $c_{1,2}$ as a factor because those are themselves elements in \mathcal{B}' . For $c_{\alpha_1} \wedge \dots \wedge c_{\alpha_t}$, $\{\alpha_1, \dots, \alpha_t\} \in BC(\mathcal{L})$, $\alpha_i \neq (1,2)$,

$$(c_{\alpha_1} - c_{1,2}) \wedge \dots \wedge (c_{\alpha_t} - c_{1,2}) = c_{\alpha_1} \wedge \dots \wedge c_{\alpha_t} + \beta,$$

where β is a linear combination of products containing $c_{1,2}$, hence of elements in \mathcal{B}' . Thus $c_{\alpha_1} \wedge \dots \wedge c_{\alpha_t}$ can be written as a linear combination of those. \square

Let \mathcal{T}^\bullet denote the submodule of $H^*(\mathcal{M}(\mathcal{A}_{n-2}^{(k)}))$ generated by those elements of \mathcal{B}' that contain $c_{1,2}$ as a factor, whereas \mathcal{T}° denotes the submodule generated by all other elements of \mathcal{B}' :

$$H^*(\mathcal{M}(\mathcal{A}_{n-2}^{(k)})) \cong \mathcal{T}^\circ \oplus \mathcal{T}^\bullet.$$

Obviously, multiplication within \mathcal{T}^\bullet is trivial, whereas for \mathcal{T}° we can state the following:

PROPOSITION 5.3 *The submodule \mathcal{T}° is a subalgebra of $H^*(\mathcal{M}(\mathcal{A}_{n-2}^{(k)}))$ generated by the elements $\bar{c}_{i,j} := (c_{i,j} - c_{1,2})$ in dimension $k - 1$, $1 \leq i < j \leq n - 1$, $(i, j) \neq (1, 2)$. It has a presentation as a quotient of the exterior algebra on these generators:*

$$\mathcal{T}^\circ \cong \Lambda^* \mathbb{Z}^{\binom{n-1}{2}-1} / J,$$

where J is the ideal generated by elements of the form

$$\begin{aligned} (\bar{c}_{i,l} \wedge \bar{c}_{j,l}) + (-1)^{k+1}(\bar{c}_{i,j} \wedge \bar{c}_{j,l}) + (\bar{c}_{i,j} \wedge \bar{c}_{i,l}), & \quad 1 \leq i < j < l \leq n-1, \\ & \quad (i, j) \neq (1, 2), \\ (\bar{c}_{1,i} \wedge \bar{c}_{2,i}), & \quad 2 < i \leq n-1. \end{aligned}$$

PROOF. It is clear that \mathcal{T}° has a presentation as a quotient of the exterior algebra on the generators $\bar{c}_{i,j} = (c_{i,j} - c_{1,2})$, $1 \leq i < j \leq n - 1$, $(i, j) \neq (1, 2)$. Moreover, it is easy to check that the proposed relations hold in $H^*(\mathcal{M}(\mathcal{A}_{n-2}^{(k)}))$. To see that they generate the ideal for a presentation of \mathcal{T}° note that they allow one to write each product in the generators $\bar{c}_{i,j}$ as a linear combination of elements from the linear basis for \mathcal{T}° : Assume that for a product of generators

$$\bar{c}_{\alpha_1} \wedge \dots \wedge \bar{c}_{\alpha_t}$$

all products with lexicographically smaller index set can be written as a linear combination of basis elements from \mathcal{T}° . If this product is not itself a basis element then $\{\alpha_1, \dots, \alpha_t\}$ contains a broken circuit of $\mathcal{L}(\mathcal{A}_{n-2}^{(k)})$. In case (1, 2) extends it to a circuit the product is zero by a relation of the second type. Otherwise, a relation of the first type allows to write it as a linear combination of products with lexicographically smaller index set, and hence as a linear combination of basis elements. \square

Our results on d_k now read as follows:

$$\begin{aligned} d_k(c_{1,2}) &= 2\nu \\ d_k(c_{i,j} - c_{1,2}) &= 0 \quad \text{for } 1 \leq i < j \leq n-1, \end{aligned}$$

where ν is a generator of $H^k(S^k)$. Evaluating d_k by the Leibniz rule on the basis elements of \mathcal{B}' we exhibit \mathcal{T}° as the kernel of d_k , whereas $\text{im } d_k = 2\mathcal{T}^\circ$, and hence $\text{coker } d_k \cong \mathcal{T}^\circ/2\mathcal{T}^\circ \oplus \mathcal{T}^\bullet$. We thus obtain the final sequence tableau $E_{k+1}^{*,*}$ with entries $E_{k+1}^{0,*} = \mathcal{T}^\circ$ and $E_{k+1}^{k,*} = \mathcal{T}^\circ/2\mathcal{T}^\circ \oplus \mathcal{T}^\bullet$.

From the sequence tableau $E_{k+1}^{*,*}$ we can read the cohomology algebra of $F(S^k, n)$: Free generators for $\mathcal{T}^\circ = E_{k+1}^{0,*}$ are located in $E_{k+1}^{0,0}$ and $E_{k+1}^{0,k-1}$. Together with the free generator in $E_{k+1}^{k,k-1}$ and the generator of order two in $E_{k+1}^{k,0}$ they generate $\mathcal{T}^\circ/2\mathcal{T}^\circ \oplus \mathcal{T}^\bullet = E_{k+1}^{k,*}$.

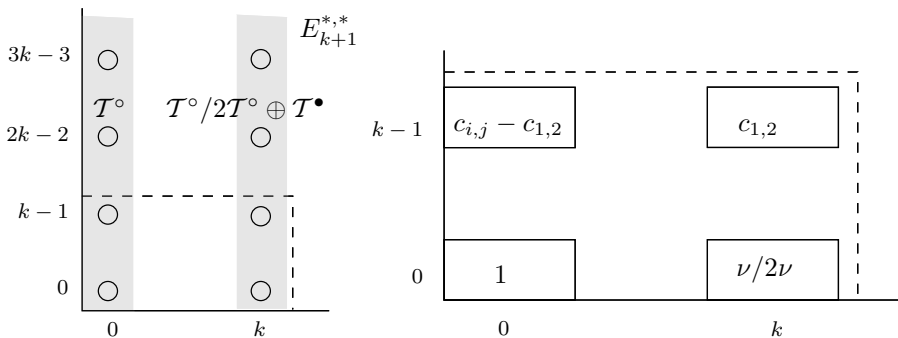

Linearly, the cohomology of $F(S^k, n)$ is isomorphic to a tensor product of two free generators in dimension 0 and $2k-1$ and a generator of order 2 in dimension $k-1$ with the algebra \mathcal{T}° :

$$H^*(F(S^k, n)) \cong (\mathbb{Z}(0) \oplus \mathbb{Z}_2(k) \oplus \mathbb{Z}(2k-1)) \otimes \mathcal{T}^\circ.$$

This isomorphism is an algebra isomorphism: This is obvious for multiplication among elements represented by entries in the left-most column $E_{k+1}^{0,*}$. Also, multiplication between entries of $E_{k+1}^{0,*}$ and $E_{k+1}^{k,*}$ is correctly described in the proposed tensor product. Moreover, the trivial multiplication among entries in $E_{k+1}^{k,*}$ has its correspondence in the tensor algebra since multiplication within the left-hand factor is trivial. We conclude:

THEOREM 5.4 *For a sphere S^k of even dimension, $k \geq 4$, the integer cohomology algebra of $F(S^k, n)$, $n \geq 3$, is given by*

$$\begin{aligned} H^*(F(S^k, n)) &\cong (\mathbb{Z}(0) \oplus \mathbb{Z}_2(k) \oplus \mathbb{Z}(2k-1)) \otimes \mathcal{T}^\circ \\ &\cong (\mathbb{Z}(0) \oplus \mathbb{Z}_2(k) \oplus \mathbb{Z}(2k-1)) \otimes \Lambda^* \bigoplus_{\binom{n-1}{2}-1} \mathbb{Z}(k-1) / J, \end{aligned}$$

where J is the ideal described in Proposition 5.3.

In the next section we will give a topological interpretation for this product decomposition of the cohomology algebra (see Remark 6.1).

6 A FAMILY OF FIBER BUNDLES

The bundle structure on $F(S^k, n)$ given by the projection Π_1 was the key to determine the integer cohomology algebra of $F(S^k, n)$. This projection Π_1 is one instance from a family of fiber maps $\Pi_r = \Pi_r(S^k, n)$, $1 \leq r < n$, that are given by projection of a configuration in $F(S^k, n)$ to its last r points. In this section we will have a closer look at these fiber maps, at their spectral sequences, and at the question whether the induced bundle structures are trivial.

For the fiber map $\Pi_r(S^k, n)$, $1 \leq r < n$, we obtain the following space as the fiber over a point configuration $q = (q_1, \dots, q_r)$ on S^k :

$$\begin{aligned} \Pi_r^{-1}(q) = \{ & (x_1, \dots, x_{n-r}) \in (S^k)^{n-r} \mid x_i \neq x_j \text{ for } i \neq j, x_i \neq q_t \\ & \text{for } i = 1, \dots, n-r, t = 1, \dots, r\}. \end{aligned}$$

This space is again a configuration space:

$$\Pi_r^{-1}(q) = F(S^k \setminus \{q_1, \dots, q_r\}, n-r).$$

Configurations on S^k that avoid $r \geq 1$ (fixed) points q_1, \dots, q_r are equivalent to configurations in \mathbb{R}^k that avoid $r-1$ points q_1, \dots, q_{r-1} . Thus the fiber of Π_r is homeomorphic to the complement of the arrangement $\mathcal{A}_{\Pi_r(S^k, n)}$ of (affine) subspaces in $\mathbb{R}^{k(n-r)}$ given by

$$\begin{aligned} U_{i,j} &= \{(x_1, \dots, x_{n-r}) \in (\mathbb{R}^k)^{n-r} \mid x_i = x_j\}, & 1 \leq i < j \leq n-r, \\ U_i^t &= \{(x_1, \dots, x_{n-r}) \in (\mathbb{R}^k)^{n-r} \mid x_i = t \cdot (1, 0, \dots, 0)^T\}, \\ & & 1 \leq i \leq n-r, 0 \leq t \leq r-2. \end{aligned}$$

For $r = 1$, the arrangement $\mathcal{A}_{\Pi_1(S^k, n)}$ coincides with the k -braid arrangement $\mathcal{A}_{n-2}^{(k)}$ — a fact that we used extensively in the previous sections. For $r > 2$, $\mathcal{A}_{\Pi_r(S^k, n)}$ contains *affine* subspaces, the subspaces U_i^t for $0 < t \leq r-2$. In the complex case, for $k = 2$, these arrangements were extensively studied by WELKER [We].

6.1 THE SPECTRAL SEQUENCES

We proved in the previous sections that the spectral sequence $E_*(\Pi_1)$ associated to the fiber map $\Pi_1(S^k, n)$ collapses in E_2 for odd k , and in E_{k+1} for even k . We obtain a similar picture for the spectral sequence $E_*(\Pi_2)$ associated to the fiber map $\Pi_2(S^k, n)$: The base space $F(S^k, 2)$ is homotopy equivalent to S^k . Hence, it is simply connected for $k \geq 2$, and the system of local coefficients on S^k induced by Π_2 is simple. The fiber $\mathcal{M}(\mathcal{A}_{\Pi_2(S^k, n)})$ is homotopy equivalent to the complement of the k -braid arrangement $\mathcal{A}_{n-2}^{(k)}$. In fact, the homotopy

equivalence is realized by projection of $\mathcal{M}(\mathcal{A}_{n-2}^{(k)})$ along $\cap \mathcal{A}_{n-2}^{(k)}$ on the linear subspace

$$U_{n-1}^0 = \{(x_1, \dots, x_{n-1}) \in (\mathbb{R}^k)^{n-1} \mid x_{n-1} = 0\}.$$

Thus, the E_2 -tableaux of the spectral sequences induced by Π_1 and Π_2 coincide. For dimensional reasons, the collapsing results on $E_*(\Pi_1)$ translate to analogous collapsing results on $E_*(\Pi_2)$.

The picture changes for the spectral sequences $E_*(\Pi_3)$ associated to $\Pi_3(S^k, n)$. In fact, we have all arguments at hand to discuss them briefly: The base space $F(S^k, 3)$ of the fiber map $\Pi_3(S^k, n)$ is homotopy equivalent to the Stiefel manifold $V_{k+1,2}$ of orthogonal 2-frames in \mathbb{R}^{k+1} [Fa, Thm. 2.4], hence it is simply connected for $k \geq 2$. We conclude that the system of local coefficients on $F(S^k, 3)$ induced by Π_3 is simple. We have seen above that the fiber of Π_3 is homeomorphic to the complement of the (affine) subspace arrangement $\mathcal{A}_{\Pi_3(S^k, n)}$. Comparison to the complement of the k -braid arrangement $\mathcal{A}_{n-2}^{(k)}$ yields a homotopy equivalence,

$$\mathcal{M}(\mathcal{A}_{\Pi_3(S^k, n)}) \simeq \mathcal{M}(\mathcal{A}_{n-2|U}^{(k)}),$$

where $\mathcal{A}_{n-2|U}^{(k)}$ denotes the restriction of the k -braid arrangement to the affine subspace

$$U = \{(x_1, \dots, x_{n-1}) \in (\mathbb{R}^k)^{n-1} \mid x_{n-2} - x_{n-1} = (1, 0, \dots, 0)^T\}.$$

The homotopy equivalence is realized by projection of $\mathcal{M}(\mathcal{A}_{n-2|U}^{(k)})$ along the intersection $\cap \mathcal{A}_{n-2}^{(k)}$ to the linear subspace

$$U_{n-1}^0 = \{(x_1, \dots, x_{n-1}) \in (\mathbb{R}^k)^{n-1} \mid x_{n-1} = 0\}.$$

The affine arrangement $\mathcal{A}_{n-2|U}^{(k)}$ is associated to the k -braid arrangement in the same way as we associated before an affine complex hyperplane arrangement to the complex braid arrangement (compare Section 2). This analogy allows one to state a presentation for its cohomology algebra in terms of generators and relations. In fact, one obtains an algebra presentation that coincides with the one that we stated for \mathcal{T}° in Proposition 5.3:

$$H^*(\mathcal{M}(\mathcal{A}_{n-2|U}^{(k)})) \cong \mathcal{T}^\circ.$$

In particular, $H^*(\mathcal{M}(\mathcal{A}_{n-2|U}^{(k)}))$ is torsion-free and it is generated in dimension $k - 1$ by cohomology classes that are in one-to-one correspondence with the inclusion maximal subspaces of the arrangement.

For both odd and even k the E_2 -tableaux of the spectral sequences associated to $\Pi_3(S^k, n)$ carry the structure of tensor products. We content ourselves with

discussing the spectral sequences for $k \geq 3$; for $k = 2$, we already showed in Section 2 that the bundle structure induced by Π_3 is trivial.

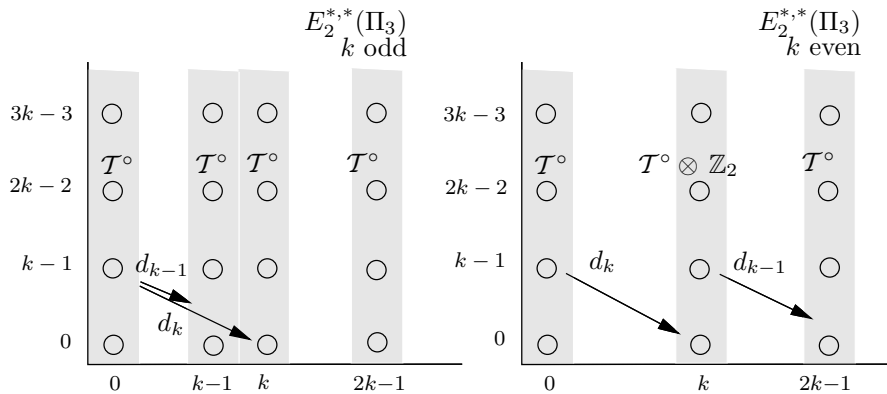

$$E_2^{p,q}(\Pi_3) \cong H^p(V_{k+1,2}) \otimes H^q(\mathcal{M}(\mathcal{A}_{n-2}^{(k)}|_U)), \quad p, q \geq 0.$$

It is easy to see that $E_*(\Pi_3)$ collapses in its second term for both odd and even k : The location of non-zero entries in the respective tableaux suffices to see the triviality of differentials d_r with $r \neq k$. The k -th cohomology group of $F(S^k, n)$ can be read already from the k -th diagonal in $E_{k+1}(\Pi_3)$. Our results on $H^k(F(S^k, n))$ (Proposition 4.2) allow to deduce triviality of the differential d_k as we did in Section 4.1.

REMARK 6.1 There is a topological explanation for the product decomposition of the integer cohomology algebra of $F(S^k, n)$ for even k that we obtained in Theorem 5.4: The factors are the cohomology algebras of base space and fiber for the fiber bundle structure on $F(S^k, n)$ given by Π_3 . We showed above that the associated spectral sequence $E_*(\Pi_3)$ collapses in its second term, which explains the product structure in cohomology.

The collapsing result on $E_*(\Pi_3)$ extends to the spectral sequences associated to the fiber maps Π_r for $r > 3$, and we can summarize as follows:

PROPOSITION 6.2 *The spectral sequence $E_*(\Pi_r)$ of the fiber map $\Pi_r(S^k, n)$ on the configuration space $F(S^k, n)$ collapses in its second term unless k is even and r equals 1 or 2. For those parameters the spectral sequence collapses in E_{k+1} .*

PROOF. We are left to show the triviality of the spectral sequence $E_*(\Pi_r)$ for $r > 3$. This we will derive from the triviality of $E_*(\Pi_3)$, thereby involving several applications of the following Lemma.

LEMMA 6.3 [Bo2, Ch. II, Thm. 14.1] *Let $F \xrightarrow{i} E \xrightarrow{\Pi} B$ be a fiber bundle with path-connected base B and assume that the cohomology of the base or the cohomology of the fiber is torsion-free. Then the following assertions are equivalent:*

- (1) *The system of local coefficients on B induced by Π is simple and the associated spectral sequence with integer coefficients collapses in its second term.*
- (2) *The induced map $i^* : H^*(E) \rightarrow H^*(F)$ is surjective.*

Consider the map of fiber bundles between $\Pi_r(S^k, n)$ and $\Pi_3(S^k, n)$ given by $(\text{id}, \Pi_3(S^k, r))$. For simplicity of notation we denote with Q_t a fixed set of pairwise distinct points $\{q_1, \dots, q_t\}$ in S^k and thus write $F(S^k \setminus Q_t, n - t)$ for the respective fibers. The fibers are complements of affine k -arrangements, thus their cohomology algebras are torsion-free.

$$\begin{array}{ccc}
 F(S^k \setminus Q_3, n - 3) & \xrightarrow{i_{\Pi_3}} & F(S^k, n) \\
 \nearrow i & \searrow \text{id} & \downarrow \Pi_3 \\
 F(S^k \setminus Q_r, n - r) & \xrightarrow{i_{\Pi_r}} & F(S^k, n) \\
 & \downarrow \Pi_r & \downarrow \Pi_3 \\
 & & F(S^k, 3) \\
 & \downarrow \Pi_r & \nearrow \Pi_3 \\
 & & F(S^k, r)
 \end{array}$$

The configuration space $F(S^k, 3)$ is simply connected for $k \geq 2$, due to the homotopy equivalence with the Stiefel manifold $V_{k+1,2}$. With the collapsing result on $E_*(\Pi_3)$ we deduce that $i_{\Pi_3}^*$ is surjective by the equivalence stated above. We are left to show that the inclusion i between the fibers induces a surjective homomorphism in cohomology. Then $i_{\Pi_r}^* = i^* \circ i_{\Pi_3}^*$ is surjective, and another application of Lemma 6.3 yields the collapsing result on $E^*(\Pi_r)$.

To see that i^* is surjective we interpret i as a concatenation of inclusions in a sequence of fiber maps. Namely, we consider the sequence of fiber maps obtained by successively projecting $F(S^k \setminus Q_1, n - 1)$ to its last coordinate. We picture the part of this sequence which is relevant to our investigation:

$$\begin{array}{ccccccc}
 F(S^k \setminus Q_r, n - r) & \xrightarrow{j_{r-1}} & \dots & \xrightarrow{j_4} & F(S^k \setminus Q_4, n - 4) & \xrightarrow{j_3} & F(S^k \setminus Q_3, n - 3) \\
 & & & & \downarrow p_4 & & \downarrow p_3 \\
 & & & & S^k \setminus Q_4 & & S^k \setminus Q_3
 \end{array}$$

The base spaces of the fiber bundles given by p_t , $1 \leq t \leq n - 2$, are simply connected for $k > 2$, thus the systems of local coefficients are simple. The same holds for $k = 2$, which is a result of COHEN [C2, Lemma 6.3]. The fibers are complements of affine k -arrangements, thus their cohomology groups are non-trivial only in dimensions that are multiples of $k - 1$ [GM, Part III, Thm. B]. For dimensional reasons, the associated spectral sequences $E_*(p_t)$ collapse in their second terms and we conclude by Lemma 6.3 that the j_t^* are surjective for $1 \leq t \leq n - 2$. Thus, $i^* = j_{r-1}^* \circ \dots \circ j_3^*$ is a surjective map, which concludes our proof. □

6.2 TRIVIALITY OF THE FIBER BUNDLES

The fiber bundle structure induced by Π_3 on $F(S^2, n)$ for $n \geq 3$ is trivial (Theorem 2.1). One is led to ask: For which parameters do the fiber maps Π_r induce a trivial fiber bundle structure on $F(S^k, n)$?

We observed in Section 2 that the bundle structure on $F(S^k, 2)$ given by Π_1 is equivalent to the tangent bundle over S^k . Thus, $\Pi_1(S^k, 2)$ is a trivial fiber map if and only if S^k is parallelizable (see HIRZEBRUCH [H]). This indicates that the triviality question for the fiber maps Π_r is difficult in general.

Our results on the cohomology algebra of $F(S^k, n)$ for even k , $k \geq 2$, exclude a trivial bundle structure on $F(S^k, n)$ induced by Π_1 : There is 2-torsion in $H^*(F(S^k, n))$ while the cohomology algebra of the cartesian product of base space and fiber is torsion-free. However, the cohomology algebra of $F(S^k, n)$ for odd k coincides with the cohomology algebra of the cartesian product of base space and fiber. Such product decomposition might as well hold beyond the level of cohomology.

Recall from previous arguments that $F(S^k, 3)$ is fiber homotopy equivalent to the Stiefel manifold $V_{k+1,2}$ of orthogonal 2-frames in \mathbb{R}^{k+1} , both considered as fiber bundles over S^k . Fiber bundles are trivial if and only if their associated principal bundles are trivial [St, Part I, Cor. 8.4]. Hence, $V_{k+1,2}$ is a trivial fiber bundle if and only if $O(k+1)$, considered as a fiber bundle over S^k , admits a section — which again is the case iff $k = 1, 3$ or 7 . Moreover, $V_{k+1,2}$ is fiber homotopy equivalent to a trivial bundle if and only if it is trivial itself, hence iff $k = 1, 3$ or 7 [Ja, Thm. 1.11]. We conclude that $F(S^k, 3)$ is a *non-trivial* fiber bundle over S^k for $k \neq 1, 3$ or 7 .

For the 1-sphere we have shown triviality of $F(S^1, n)$ as a fiber bundle over S^1 in Section 2. Analogously, we obtain a trivialization of the fiber bundle structure on $F(S^3, n)$ given by Π_1 , using the group structure of S^3 . The 7-sphere does not carry the structure of a topological group [Bd, VI, Cor. 15.21]. However, one can establish an explicit equivalence of fiber bundles between $F(S^7, 3)$ and $V_{8,2} \times \mathbb{R}^7 \times \mathbb{R}$, both considered as fiber bundles over S^7 in the natural way. As mentioned above, $V_{8,2}$ is a trivial fiber bundle over S^7 , and we can thus conclude triviality of $F(S^7, 3)$ over S^7 .

Thus it remains to decide whether the bundle structure on $F(S^k, n)$ induced by Π_1 is trivial for $n > 3$ and odd $k \geq 5$.

We have seen in Section 2 that Π_3 induces a trivial bundle structure on $F(S^2, n)$. Our collapsing results on the spectral sequences $E_*(\Pi_3(S^k, n))$ for both odd and even k would be consistent with triviality of the fiber bundle structure given by Π_3 . However, except for $k = 2$ this leaves us with an open question.

REMARK 6.4 After completion of this paper, we learned about recent work by FADELL & HUSSEINI [FaH] which addresses the question of configuration space bundles being (fiber-homotopically) trivial. The paper is mostly concerned with configuration spaces of Euclidean spaces; a complete discussion for

configuration spaces of spheres is announced, but the results are stated only for spheres of odd dimension.

REFERENCES

- [An] D.W. Anderson: *A generalization of the Eilenberg-Moore spectral sequence*; Bull. Amer. Math. Soc. 78 (1972), 784–788.
- [Ar] V.I. Arnol'd: *The cohomology ring of the colored braid group*; Mat. Zametki 5 (1969), 227–231; Math. Notes 5 (1969), 138–140.
- [Bj] A. Björner: *Subspace Arrangements*; in: *Proc. First European Congress of Mathematics, Paris 1992* (A. Joseph et al., eds.), Birkhäuser, Basel, 1994, pp. 321–370.
- [BZ] A. Björner, G.M. Ziegler: *Combinatorial stratification of complex arrangements*; J. Amer. Math. Soc. 5 (1992), 105–149.
- [Bo1] A. Borel: *Cohomologie des espaces localement compacts d'après J. Leray*; Lecture Notes in Mathematics vol. 2, Springer-Verlag 1964.
- [Bo2] A. Borel: *Topics in the Homology Theory of Fibre Bundles*; Lecture Notes in Mathematics vol. 36, Springer-Verlag 1967.
- [Bd] G.E. Bredon: *Topology and Geometry*; Graduate Texts in Mathematics 129, Springer-Verlag 1993.
- [C1] F. Cohen: *Cohomology of braid spaces*; Bull. Amer. Math. Soc. 79 (1973), 763–766.
- [C2] F. Cohen: *The homology of C_{n+1} -spaces, $n \geq 0$* ; in: F. Cohen, T. Lada, P. May: *The homology of iterated loop spaces*; Lecture Notes in Mathematics vol. 533, Springer-Verlag 1976, pp. 207–351.
- [C3] F. Cohen: *Homology of $\Omega^{n+1}\Sigma^{n+1}X$ and $C_{n+1}X$, $n > 0$* ; Bull. Amer. Math. Soc. 79 (1973), 1236–1241.
- [CT1] F. Cohen, L. Taylor: *Configuration spaces: Applications to Gelfand-Fuks cohomology*; Bull. Amer. Math. Soc. 84 (1978), 134–136.
- [CT2] F. Cohen, L. Taylor: *Computations of Gelfand-Fuks cohomology, the cohomology of function spaces, and the cohomology of configuration spaces*; in: *Geometric Applications of Homotopy Theory I, Proceedings, Evanston 1977*; Lecture Notes in Mathematics vol. 657, Springer-Verlag 1978, pp. 106–143.
- [DP] C. De Concini, C. Procesi: *Wonderful models of subspace arrangements*; Selecta Math., New Series 1 (1995), 459–494.
- [Fa] E. Fadell: *Homotopy groups of configuration spaces and the string problem of Dirac*; Duke Math. J. 29 (1962), 231–242.
- [FaH] E. Fadell, S. Husseini: *When are configuration bundles fiber-homotopically trivial?*; preprint, 13 pages.
- [FaN] E. Fadell, L. Neuwirth: *Configuration spaces*; Math. Scand. 10 (1962), 111–118.
- [FFG] A.T. Fomenko, D.B. Fuks, V.L. Gutenmacher: *Homotopic Topology*; Akadémiai Kiadó, Budapest 1986.

- [FM] W. Fulton, R.D. MacPherson: *A compactification of configuration spaces*; Ann. of Math. (2) 139 (1994), 183–225.
- [GF] I.M. Gelfand, D.B. Fuks: *The cohomology of the Lie algebra of tangent vector fields on a smooth manifold I, II*; Functional Anal. Appl. 3 (1969), 194–210; Functional Anal. Appl. 4 (1970), 110–116.
- [Ge] E. Getzler: personal communication, Sept. 1996.
- [GM] M. Goresky, R.D. MacPherson: *Stratified Morse Theory*; Ergebnisse der Mathematik und ihrer Grenzgebiete, 3. Folge, Band 14, Springer-Verlag 1988.
- [H] F. Hirzebruch: *Division algebras and topology*; in: H.D. Ebbinghaus, et al.: *Numbers*; Graduate Texts in Mathematics 123, Springer-Verlag 1990, pp. 281–302.
- [Ja] I.M. James: *The Topology of Stiefel Manifolds*; London Mathematical Society Lecture Note Series 24, Cambridge University Press 1976.
- [Kr] I. Kriz: *On the rational homotopy type of configuration spaces*; Ann. of Math. 139 (1994), 227–237.
- [MS] J.W. Milnor, J.D. Stasheff: *Characteristic Classes*; Annals of Mathematics Studies, Princeton University Press 1974.
- [Mu] J.R. Munkres: *Elements of Algebraic Topology*; Addison Wesley 1984.
- [OS] P. Orlik, L. Solomon: *Combinatorics and topology of complements of hyperplanes*; Inventiones Math. 56 (1980), 167–189.
- [OT] P. Orlik, H. Terao: *Arrangements of Hyperplanes*; Grundlehren der mathematischen Wissenschaften 300, Springer-Verlag 1992.
- [P] G. Pickert: *Projektive Ebenen*; Springer-Verlag 1955.
- [St] N. Steenrod: *The Topology of Fibre Bundles*; Princeton University Press 1951.
- [T] B. Totaro: *Configuration spaces of algebraic varieties*; Topology 35 (1996), 1057–1067.
- [We] V. Welker: *Colored partitions and a generalization of the braid arrangement*; Electr. J. Comb. 4 (1997), R4.
- [Wh] G.W. Whitehead: *Elements of Homotopy Theory*; Graduate Texts in Mathematics 61, Springer-Verlag 1978.
- [ZŽ] G.M. Ziegler, R. Živaljević: *Homotopy types of subspace arrangements via diagrams of spaces*; Math. Ann. 295 (1993), 527–548.

Eva Maria Feichtner
 Dept. Mathematics, MA 7-1
 TU Berlin
 10623 Berlin, Germany

Current address:

Dept. Mathematics
 ETH Zürich
 8092 Zürich, Switzerland
 feichtne@math.ethz.ch

Günter M. Ziegler
 Dept. Mathematics, MA 7-1
 TU Berlin
 10623 Berlin, Germany
 ziegler@math.tu-berlin.de

SOME BOUNDEDNESS RESULTS FOR
FANO-LIKE MOISHEZON MANIFOLDS

LAURENT BONAVERO AND SHIGEHARU TAKAYAMA

Received: February 2, 2000

Communicated by Thomas Peternell

ABSTRACT. We prove finiteness of the number of smooth blow-downs on Fano manifolds and boundedness results for the geometry of non projective Fano-like manifolds. Our proofs use properness of Hilbert schemes and Mori theory.

2000 Mathematics Subject Classification: 14J45, 14E30, 14E05, 32J18.

Keywords and Phrases: Fano manifolds, non projective manifold, smooth blow-down, Mori theory, Hilbert scheme.

INTRODUCTION

In this Note, we say that a compact complex manifold X is a *Fano-like manifold* if it becomes Fano after a finite sequence of blow-ups along smooth connected centers, *i.e.* if there exist a Fano manifold \tilde{X} and a finite sequence of blow-ups along smooth connected centers $\pi : \tilde{X} \rightarrow X$. We say that a Fano-like manifold X is *simple* if there exists a smooth submanifold Y of X (Y may not be connected) such that the blow-up of X along Y is Fano. If Z is a projective manifold, we call *smooth blow-down of Z (with an s -dimensional center)* a map π and a manifold Z' such that $\pi : Z \rightarrow Z'$ is the blow-up of Z' along a smooth connected submanifold (of dimension s). We say that a smooth blow-down of Z is projective (resp. non projective) if Z' is projective (resp. non projective).

It is well-known that any Moishezon manifold becomes projective after a finite sequence of blow-ups along smooth centers. Our aim is to bound the geometry of *Moishezon manifolds becoming Fano after one blow-up along a smooth center*, *i.e.* the geometry of *simple non projective Fano-like manifolds*.

Our results in this direction are the following, the simple proof of Theorem 1 has been communicated to us by Daniel Huybrechts.

THEOREM 1. *Let Z be a Fano manifold of dimension n . Then, there is only a finite number of smooth blow-downs of Z .*

Let us recall here that the assumption Z Fano is essential : there are projective smooth surfaces with infinitely many -1 rational curves, hence with infinitely many smooth blow-downs.

Since there is only a finite number of deformation types of Fano manifolds of dimension n (see [KMM92] and also [Deb97] for a recent survey on Fano manifolds) and since smooth blow-downs are stable under deformations [Kod63], we get the following corollary (see section 1 for a detailed proof) :

COROLLARY 1. *There is only a finite number of deformation types of simple Fano-like manifolds of dimension n .*

The next result is essentially due to Wiśniewski ([Wis91], prop. (3.4) and (3.5)). Before stating it, let us define

$$d_n = \max\{(-K_Z)^n \mid Z \text{ is a Fano manifold of dimension } n\}$$

and

$$\rho_n = \max\{\rho(Z) := \text{rk}(\text{Pic}(Z)/\text{Pic}^0(Z)) \mid Z \text{ is a Fano manifold of dimension } n\}.$$

The number ρ_n is well defined since there is only a finite number of deformation types of Fano manifolds of dimension n and we refer to [Deb97] for an explicit bound for d_n .

THEOREM 2. *Let X be an n -dimensional simple non projective Fano-like manifold, Y a smooth submanifold such that the blow-up $\pi : \tilde{X} \rightarrow X$ of X along Y is Fano, and E the exceptional divisor of π . Then*

- (i) *if each component of Y has Picard number equal to one, then each component of Y has ample conormal bundle in X and is Fano. Moreover*

$$\deg_{-K_{\tilde{X}}}(E) := (-K_{\tilde{X}|E'})^{n-1} \leq (\rho_n - 1)d_{n-1};$$

- (ii) *if Y is a curve, then (each component of) Y is a smooth rational curve with normal bundle $\mathcal{O}_{\mathbb{P}^1}(-1)^{\oplus n-1}$.*

Finally, we prove here the following result :

THEOREM 3. *Let Z be a Fano manifold of dimension n and index r . Suppose there is a non projective smooth blow-down of Z with an s -dimensional center. Then*

$$r \leq (n-1)/2 \text{ and } s \geq r.$$

Moreover,

- (i) *if $r > (n-1)/3$, then $s = n-1-r$;*
 (ii) *if $r < (n-1)/2$ and $s = r$, then $Y \simeq \mathbb{P}^r$.*

Recall that the index of a Fano manifold Z is the largest integer m such that $-K_Z = mL$ for L in the Picard group of Z .

REMARKS.

- a) For a Fano manifold X of dimension n and index r with second Betti number greater than or equal to 2, it is known that $2r \leq n+2$ [Wi91], with equality if and only if $X \simeq \mathbb{P}^{r-1} \times \mathbb{P}^{r-1}$.

- b) Fano manifolds of even dimension (resp. odd dimension n) and middle index (resp. index $(n+1)/2$) with $b_2 \geq 2$ have been intensively studied, see for example [Wis93]. Our Theorem 3 shows that there are no non projective smooth blow-down of such a Fano manifold, without using any explicit classification.
- c) The assumption that there is a *non projective* smooth blow-down of Z is essential in Theorem 3 (i) : the Fano manifold obtained by blowing-up \mathbb{P}^{2r-1} along a \mathbb{P}^{r-2} has index r .

1. PROOF OF THEOREM 1 AND COROLLARY 1. AN EXAMPLE.

1.1. PROOF OF THEOREM 1. *Thanks to D. Huybrechts for the following proof.* Let Z be a Fano manifold and $\pi : Z \rightarrow Z'$ a smooth blow-down of Z with an s -dimensional connected center. Let f be a line contained in a non trivial fiber of π . Then, the Hilbert polynomial $P_{-K_Z}(m) := \chi(f, m(-K_Z)|_f)$ is determined by s and n since $-K_Z \cdot f = n - s - 1$ and f is a smooth rational curve. Since $-K_Z$ is ample, the Hilbert scheme Hilb_{-K_Z} of curves in Z having P_{-K_Z} as Hilbert polynomial is a projective scheme, hence has a finite number of irreducible components. Since each curve being in the component \mathcal{H} of Hilb_{-K_Z} containing f is contracted by π , there is only a finite number of smooth blow-downs of Z with an s -dimensional center. \square

1.2. PROOF OF COROLLARY 1. Let us first recall ([Deb97] section 5.2) that there exists an integer $\delta(n)$ such that every Fano n -fold can be realized as a smooth submanifold of \mathbb{P}^{2n+1} of degree at most $\delta(n)$. Let us denote by T a closed irreducible subvariety of the disjoint union of Chow varieties of n -dimensional subvarieties of \mathbb{P}^{2n+1} of degree at most $\delta(n)$, and by $\pi : \mathcal{X}_T \rightarrow T$ the universal family.

Step 1 : Stability of smooth blow-downs. Fix t_0 in the smooth locus T_{smooth} of T and suppose that $X_{t_0} := \pi^{-1}(t_0)$ is a Fano n -fold and there exists a smooth blow-down of X_{t_0} (denote by E_{t_0} the exceptional divisor, P its Hilbert polynomial with respect to $\mathcal{O}_{\mathbb{P}^{2n+1}}(1)$). Let S be the component of the Hilbert scheme of $(n-1)$ -dimensional subschemes of \mathbb{P}^{2n+1} with Hilbert polynomial P and $u : \mathcal{E}_S \rightarrow S$ the universal family. Finally, let I be the following subscheme of $T \times S$:

$$I = \{(t, s) \mid u^{-1}(s) \subset X_t\}$$

and $p : I \rightarrow T$ the proper algebraic map induced by the first projection. Thanks to the analytic stability of smooth blow-downs due to Kodaira (see [Kod63], Theorem 5), the image $p(I)$ contains an analytic open neighbourhood of t_0 hence it also contains a Zariski neighbourhood of t_0 . Moreover, since exceptional divisors are rigid, the fiber $p^{-1}(t)$ is a single point for t in a Zariski neighbourhood of t_0 . Finally, we get algebraic stability of smooth blow-downs (the \mathbb{P}^r -fibered structure of exceptional divisor is also analytically stable - [Kod63], Theorem 4 - hence algebraically stable by the same kind of argument).

Step 2 : Stratification of T by the number of smooth blow-downs. For any integer $k \geq 0$, let us define

$$U_k(T) = \{t \in T_{smooth} \mid X_t \text{ is a Fano manifold and there exists at least } k \text{ smooth blow-downs of } X_t\};$$

and $U_{-1}(T) = T_{smooth}$. Thanks to Step 1, $U_k(T)$ is Zariski open in T , and thanks to Theorem 1,

$$\bigcap_{k \geq -1} U_k(T) = \emptyset.$$

Since $\{U_k(T)\}_{k \geq -1}$ is a decreasing sequence of Zariski open sets, by noetherian induction, we get that there exists an integer k such that $U_k(T) = \emptyset$ and we can thus define

$$k(T) := \max\{k \geq -1 \mid U_k(T) \neq \emptyset\}, \quad U(T) := U_{k(T)}(T).$$

Finally, we have proved that $U(T)$ is a non empty Zariski open set of T_{smooth} such that for every $t \in U(T)$, Z_t is a Fano n -fold with exactly $k(T)$ smooth blow-downs ($k(T) = -1$ means that for every $t \in T_{smooth}$, X_t is not a Fano manifold).

Now let $T_0 = T$, and T_1 be any closed irreducible component of $T_0 \setminus U(T_0)$. We get $U(T_1)$ as before and denote by T_2 any closed irreducible component of $T_1 \setminus U(T_1)$, and so-on. Again by noetherian induction, this process terminates after finitely many steps and we get a finite stratification of T such that each strata corresponds to an algebraic family of Fano n -folds with the same number of smooth blow-downs.

Step 3 : Conclusion. Since there is only a finite number of irreducible components in the Chow variety of Fano n -folds, each being finitely stratified by Step 2, we get a finite number of deformation types of simple Fano-like n -folds. \square

As it has been noticed by Kodaira, it is essential to consider only *smooth* blow-downs. A -2 rational smooth curve on a surface is, in general, not stable under deformations of the surface.

1.3. AN EXAMPLE. Before going further, let us recall the following well known example. Let Z be the projective 3-fold obtained by blowing-up \mathbb{P}^3 along a smooth curve of type $(3, 3)$ contained in a smooth quadric \mathcal{Q} of \mathbb{P}^3 . Let π denotes the blow-up $Z \rightarrow \mathbb{P}^3$. Then Z is a Fano manifold of index one and there are at least three smooth blow-downs of Z : π , which is projective, and two non projective smooth blow-downs consisting in contracting the strict transform \mathcal{Q}' of the quadric \mathcal{Q} along one of its two rulings (the normal bundle of \mathcal{Q}' in Z is $\mathcal{O}(-1, -1)$).

LEMMA 1. *There are exactly three smooth blow-downs of Z .*

PROOF : the Mori cone $NE(Z)$ is a 2-dimensional closed cone, one of its two extremal rays being generated by the class of a line f_π contained in a non trivial fiber of π , the other one, denoted by $[R]$, by the class of one of the two rulings

of \mathcal{Q}' (the two rulings are numerically equivalent, the corresponding extremal contraction consists in contracting \mathcal{Q}' to a singular point in a projective variety, hence is not a smooth blow-down). If E is the exceptional divisor of π , we have

$$E \cdot [f_\pi] = -1, E \cdot [R] = 3, \mathcal{Q}' \cdot [f_\pi] = 1, \mathcal{Q}' \cdot [R] = -1.$$

Now suppose there exists a smooth blow-down τ of Z with a 1-dimensional center, which is not one of the three previously described. Let L be a line contained in a non trivial fiber of τ , then since $-K_Z \cdot [L] = 1$, we have $[L] = a[f_\pi] + b[R]$ for some strictly positive numbers such that $a + b = 1$. Since we have moreover

$$\mathcal{Q}' \cdot [L] = a - b = 2a - 1 \in \mathbb{Z} \text{ and } E \cdot [L] = 3b - a = 3 - 4a,$$

we get $a = b = 1/2$. Therefore $\mathcal{Q}' \cdot [L] = 0$ hence L is disjoint from \mathcal{Q}' (it can not be contained in \mathcal{Q}' since $\mathcal{Q}'_{\mathcal{Q}'} = \mathcal{O}(-1, -1)$). It implies that there are two smooth blow-downs of Z with disjoint exceptional divisors, which is impossible since $\rho(Z) = 2$.

Finally, if there is a smooth blow-down $\tau : Z \rightarrow Z'$ of Z with a 0-dimensional center, then Z' is projective and τ is a Mori extremal contraction, which is again impossible since we already met the two Mori extremal contractions on Z . \square

2. NON PROJECTIVE SMOOTH BLOW-DOWNS ON A CENTER WITH PICARD NUMBER 1. PROOF OF THEOREM 2.

The proof of Theorem 2 we will give is close to Wiśniewski's one but we give two intermediate results of independent interest.

2.1. ON THE NORMAL BUNDLE OF THE CENTER. Let us recall that a smooth submanifold A in a complex manifold W is contractible to a point (i.e. there exists a complex space W' and a map $\mu : W \rightarrow W'$ which is an isomorphism outside A and such that $\mu(A)$ is a point) if and only if $N_{A/W}^*$ is ample (Grauert's criterion [Gra62]).

The following proposition was proved by Campana [Cam89] in the case where Y is a curve and $\dim(X) = 3$.

PROPOSITION 1. *Let X be a non projective manifold, Y a smooth submanifold of X such that the blow-up $\pi : \tilde{X} \rightarrow X$ of X along Y is projective. Then, for each connected component Y' of Y with $\rho(Y') = 1$, the conormal bundle $N_{Y'/X}^*$ is ample.*

Before the proof, let us remark that Y is projective since the exceptional divisor of π is.

PROOF OF PROPOSITION 1 : (following Campana) we can suppose that Y is connected. Let E be the exceptional divisor of π and f a line contained in a non trivial fiber of π . Since $E \cdot f = -1$, there is an extremal ray R of the Mori cone $\overline{\text{NE}}(\tilde{X})$ such that $E \cdot R < 0$. Since $E \cdot R < 0$, R defines an extremal ray of the Mori cone $\overline{\text{NE}}(E)$ which we still denote by R (even if $\overline{\text{NE}}(E)$ is not a subcone

of $\overline{NE}(\tilde{X})$ in general !). Since $\rho(Y) = 1$, we have $\rho(E) = 2$, hence $\overline{NE}(E)$ is a 2-dimensional closed cone, one of its two extremal rays being generated by f . Then :

- either R is not generated by f and $E|_E$ is strictly negative on $\overline{NE}(E) \setminus \{0\}$. In that case, $-E|_E = \mathcal{O}_E(1)$ is ample by Kleiman's criterion, which means that $N_{Y/X}^*$ is ample.
- or, R is generated by f . In that case, the Mori contraction $\varphi_R : \tilde{X} \rightarrow Z$ factorizes through $\pi :$

$$\begin{array}{ccc}
 \tilde{X} & \xrightarrow{\varphi_R} & Z \\
 \pi \downarrow & \nearrow \psi & \\
 X & &
 \end{array}$$

where $\psi : X \rightarrow Z$ is an isomorphism outside Y . Since the variety Z is projective and X is not, ψ is not an isomorphism and since $\rho(Y) = 1$, Y is contracted to a point by ψ , hence $N_{Y/X}^*$ is ample by Grauert's criterion. \square

Let us prove the following consequence of Proposition 1:

PROPOSITION 2. *Let X be a non projective manifold, Y a smooth submanifold of X such that the blow-up $\pi : \tilde{X} \rightarrow X$ of X along Y is projective with $-K_{\tilde{X}}$ numerically effective (nef). Then, each connected component Y' of Y with $\rho(Y') = 1$ is a Fano manifold.*

PROOF : we can suppose that Y is connected. Let E be the exceptional divisor of π . Since $-E|_E$ is ample by Proposition 1, the adjunction formula $-K_E = -K_{\tilde{X}|_E} - E|_E$ shows that $-K_E$ is ample, hence E is Fano. By a result of Szurek and Wiśniewski [SZW90], Y is itself Fano. \square

2.2. PROOF OF THEOREM 2. For the first assertion, we only have to prove that

$$\text{deg}_{-K_{\tilde{X}}}(E) \leq (\rho_n - 1)d_{n-1}.$$

Let Y' be a connected component of Y and $E' = \pi^{-1}(Y')$. Then, since $-E|_{E'}$ is ample :

$$\text{deg}_{-K_{\tilde{X}}}(E') = (-K_{\tilde{X}|_{E'}})^{n-1} = (-K_{E'} + E|_{E'})^{n-1} \leq (-K_{E'})^{n-1} \leq d_{n-1}.$$

Now, if m is the number of connected components of Y , then

$$\rho_n \geq \rho(\tilde{X}) = m + \rho(X) \geq m + 1.$$

Putting all together, we get

$$\text{deg}_{-K_{\tilde{X}}}(E) \leq (\rho_n - 1)d_{n-1},$$

which ends the proof of the first point.

We refer to [Wis91] prop. (3.5) for the second point. \square

3. ON THE DIMENSION OF THE CENTER OF NON PROJECTIVE SMOOTH BLOW-DOWNS. PROOF OF THEOREM 3.

Theorem 3 is a by-product of the more precise following statement and of Proposition 3 below :

THEOREM 4. *Let Z be a Fano manifold of dimension n and index r , $\pi : Z \rightarrow Z'$ be a non projective smooth blow-down of Z , $Y \subset Z'$ the center of π . Let f be a line contained in a non trivial fiber of π , then*

- (i) *if f generates an extremal ray of $\text{NE}(Z)$, then $\dim(Y) \geq (n - 1)/2$.*
- (ii) *if f does not generate an extremal ray of $\text{NE}(Z)$, then $\dim(Y) \geq r$. Moreover, if $\dim(Y) = r$, then Y is isomorphic to \mathbb{P}^r .*

In both cases (i) and (ii), Y contains a rational curve.

The proof relies on Wiśniewski's inequality (see [Wis91] and [AnW95]), which we recall now for the reader's convenience : let $\varphi : X \rightarrow Y$ be a Fano-Mori contraction (i.e $-K_X$ is φ -ample) on a projective manifold X , $\text{Exc}(\varphi)$ its exceptional locus and

$$l(\varphi) := \min\{-K_X \cdot C ; C \text{ rational curve contained in } \text{Exc}(\varphi)\}$$

its length, then for every non trivial fiber F :

$$\dim \text{Exc}(\varphi) + \dim(F) \geq \dim(X) - 1 + l(\varphi).$$

PROOF OF THEOREM 4. The method of proof is taken from Andreatta's recent paper [And99] (see also [Bon96]).

First case : suppose that a line f contained in a non trivial fiber of π generates an extremal ray R of $\text{NE}(Z)$. Then the Mori contraction $\varphi_R : Z \rightarrow W$ factorizes through π :

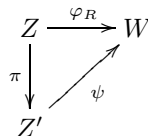

where ψ is an isomorphism outside Y . In particular, the exceptional locus E of π is equal to the exceptional locus of the extremal contraction φ_R .

Let us now denote by ψ_Y the restriction of ψ to Y , $s = \dim(Y)$, π_E and $\varphi_{R,E}$ the restriction of π and φ_R to E . Since Z' is not projective, ψ_Y is not a finite map. Since φ_R is birational, W is \mathbb{Q} -Gorenstein, hence K_W is \mathbb{Q} -Cartier and $K_{Z'} = \psi^* K_W$. Therefore, $K_{Z'}$ is ψ -trivial, hence $K_Y + \det N_{Y/Z'}$ is ψ_Y -trivial. Moreover, $\mathcal{O}_E(1) = -E|_E$ is $\varphi_{R,E}$ -ample by Kleiman's criterion, hence $N_{Y/Z'}$ is ψ_Y -ample. Finally, ψ_Y is a Fano-Mori contraction, of length greater or equal to $n - s = \text{rk}(N_{Y/Z'})$. Together with Wiśniewski's inequality applied on Y , we get that for every non trivial fiber F of ψ_Y

$$2s \geq \dim(F) + \dim \text{Exc}(\psi_Y) \geq n - s + s - 1$$

hence $2s \geq n - 1$. Moreover, $\text{Exc}(\psi_Y)$ is covered by rational curves, hence Y contains a rational curve.

Second case : suppose that a line f contained in a non trivial fiber of π does not generate an extremal ray R of $\text{NE}(Z)$. In that case, since $E \cdot f = -1$, there is an extremal ray R of $\text{NE}(Z)$ such that $E \cdot R < 0$. In particular, the exceptional locus $\text{Exc}(R)$ of the extremal contraction φ_R is contained in E , and since f is not on R , we get for any fiber F of φ_R :

$$\dim(F) \leq s = \dim(Y).$$

By the adjunction formula, $-K_E = -K_{Z|E} - E|_E$, the length $l_E(R)$ of R as an extremal ray of E satisfies

$$l_E(R) \geq r + 1,$$

where r is the index of Z . Together with Wiśniewski's inequality applied on E , we get :

$$r + 1 + (n - 1) - 1 \leq s + \dim(\text{Exc}(R)) \leq s + n - 1.$$

Finally, we get $r \leq s$, and since the fibers of φ_R are covered by rational curves, there is a rational curve in Y . Suppose now (up to the end) that $r = s$. Then E is the exceptional locus of the Mori extremal contraction φ_R . Moreover, $K_Z + r(-E)$ is a good supporting divisor for φ_R , and since every non trivial fiber of φ_R has dimension r , φ_R is a smooth projective blow-down. In particular, the restriction of π to a non trivial fiber $F \simeq \mathbb{P}^r$ induces a finite surjective map $\pi : F \simeq \mathbb{P}^r \rightarrow Y$ hence $Y \simeq \mathbb{P}^r$ by a result of Lazarsfeld [Laz83].

This ends the proof of Theorem 4. \square

The proof of Theorem 4 does not use the hypothesis Z Fano in the first case. We therefore have the following :

COROLLARY 2. *Let Z be a projective manifold of dimension n , $\pi : Z \rightarrow Z'$ be a non projective smooth blow-down of Z , $Y \subset Z'$ the center of π . Let f be a line contained in a non trivial fiber of π and suppose f generates an extremal ray of $\overline{\text{NE}}(Z)$. Then $\dim(Y) \geq (n - 1)/2$. Moreover, if $\dim(Y) = (n - 1)/2$, then Y is contractible on a point.*

We finish this section by the following easy proposition, which combined with Theorem 4 implies Theorem 3 of the Introduction :

PROPOSITION 3. *Let Z be a Fano manifold of dimension n and index r , $\pi : Z \rightarrow Z'$ be a smooth blow-down of Z , $Y \subset Z'$ the center of π . Then $n - 1 - \dim(Y)$ is a multiple of r .*

PROOF. Write

$$-K_Z = rL \quad \text{and} \quad -K_Z = -\pi^*K_{Z'} - (n - 1 - \dim(Y))E$$

where E is the exceptional divisor of π . Let f be a line contained in a fiber of π . Then $rL \cdot f = n - 1 - \dim(Y)$, which ends the proof. \square

PROOF OF THEOREM 3. Let Z be a Fano manifold of dimension n and index r and suppose there is a non projective smooth blow-down of Z with an s -dimensional center. By Proposition 3, there is a strictly positive integer k such that $n - 1 - kr = s$. By Theorem 4, either $n - 1 - kr \geq (n - 1)/2$ or

$n - 1 - kr \geq r$. In both cases, it implies that $r \leq (n - 1)/2$ and therefore $s \geq r$. If $r > (n - 1)/3$, since $n - 1 \geq (k + 1)r > (k + 1)(n - 1)/3$, we get $k = 1$ and $s = n - 1 - r$. \square

4. RATIONAL CURVES ON SIMPLE MOISHEZON MANIFOLDS.

The arguments of the previous section can be used to deal with the following well-known question : *does every non projective Moishezon manifold contain a rational curve ?* The answer is positive in dimension three (it is due to Peternell [Pet86], see also [CKM88] p. 49 for a proof using the completion of Mori's program in dimension three).

PROPOSITION 4. *Let Z be a projective manifold, $\pi : Z \rightarrow Z'$ be a non projective smooth blow-down of Z . Then Z' contains a rational curve.*

PROOF. With the notations of the previous section, it is clear in the first case where a line f contained in a non trivial fiber of π generates an extremal ray R of $\overline{NE}(Z)$ (in that case, the center of π contains a rational curve). In the second case, since f is not extremal and K_Z is not nef, there is a Mori contraction φ on Z such that any rational curve contained in a fiber of φ is mapped by π to a non constant rational curve in Z' . \square

REFERENCES

- [And99] M. Andreatta. Moishezon manifolds. *Math. Zeitschrift*, 230, 713-726 (1999).
- [AnW95] M. Andreatta, J. Wiśniewski. A view on contractions of higher-dimensional varieties. *Algebraic geometry—Santa Cruz, 153–183, (1995) Proc. Sympos. Pure Math., 62, Part 1, Amer. Math. Soc., Providence, RI, (1997)*.
- [Bon96] L. Bonavero. Sur des variétés de Moishezon dont le groupe de Picard est de rang un. *Bull. Soc. Math. Fr.* 124, No.3, 503-521 (1996).
- [Cam89] F. Campana. Critère de projectivité de la transformation élémentaire d'une variété projective de dimension 3. *C. R. Acad. Sci., Paris, Ser. I* 309, No.14, 863-866 (1989).
- [CKM88] H. Clemens, J. Kollár, S. Mori. Higher dimensional complex geometry. *Société Mathématique de France, Astérisque 166 (1988)*.
- [Deb97] O. Debarre. Variétés de Fano. *Séminaire Bourbaki. Volume 1996/97. Exposés 820–834. Paris, Société Mathématique de France, Astérisque 245, 197-221, Exp. No.827 (1997)*.
- [Gra62] H. Grauert. Ueber Modifikationen und exzeptionelle analytische Mengen. *Math. Ann.* 146, 331-368 (1962).
- [Kod63] K. Kodaira. On stability of compact submanifolds of complex manifolds. *Amer. J. Math.*, 85, 79-94 (1963).
- [KMM92] J. Kollár, Y. Miyaoka, S. Mori. Rational connectedness and boundedness of Fano manifolds. *J. Diff. Geom.* 36, 765-769 (1992).

- [Laz83] R. Lazarsfeld. Some applications of the theory of positive vector bundles. *Complete intersections, Lect. 1st Sess. C.I.M.E., Acireale/Italy 1983, Lect. Notes Math. 1092, 29-61 (1984)*.
- [Pet86] T. Peternell. Rational curves on a Moishezon 3-fold. *Complex Analysis and Algebraic Geometry. Springer LN 1194, 133-144 (1986)*.
- [SzW90] M. Szurek, J. Wiśniewski. Fano bundles over \mathbb{P}^3 and Q^3 . *Pac. J. Math. 141, No.1, 197-208 (1990)*.
- [Wis91] J. Wiśniewski. On contractions of extremal rays of Fano manifolds. *J. Reine Angew. Math. 417, 141-157 (1991)*.
- [Wi91] J. Wiśniewski. On Fano manifolds of large index. *Manuscripta Math. 70, no. 2, 145-152 (1991)*.
- [Wis93] J. Wiśniewski. A report on Fano manifolds of middle index and $b_2 \geq 2$. *Mathematica Gottingensis, Schriftenreihe des Sonderforschungsbereichs Geometrie und Analysis. Heft 16 (1993)*.

Laurent Bonavero
Institut Fourier, UMR 5582
Université de Grenoble 1
BP 74.
38402 Saint Martin d'Hères
France
bonavero@ujf-grenoble.fr

Shigeharu Takayama
Department of Mathematics
Graduate School of Science
Osaka University
Toyonaka, Osaka, 560-0043
Japan
taka@math.sci.osaka-u.ac.jp

ON THE MILNOR K -GROUPS OF
COMPLETE DISCRETE VALUATION FIELDS

JINYA NAKAMURA

Received: April 5, 2000

Communicated by A. Merkurjev

ABSTRACT. For a discrete valuation field K , the unit group K^\times of K has a natural decreasing filtration with respect to the valuation, and the graded quotients of this filtration are given in terms of the residue field. The Milnor K -group $K_q^M(K)$ is a generalization of the unit group, and it also has a natural decreasing filtration. However, if K is of mixed characteristics and has an absolute ramification index greater than one, the graded quotients of this filtration are not yet known except in some special cases.

The aim of this paper is to determine them when K is absolutely tamely ramified discrete valuation field of mixed characteristics $(0, p > 2)$ with possibly imperfect residue field.

Furthermore, we determine the kernel of the Kurihara's K_q^M -exponential homomorphism from the differential module to the Milnor K -group for such a field.

1991 Mathematics Subject Classification: 19D45, 11S70

Keywords and Phrases: The Milnor K -group, Complete Discrete Valuation Field, Higher Local Class Field Theory

1 INTRODUCTION

For a ring R , the Milnor K -group of R is defined as follows. We denote the unit group of R by R^\times . Let $J(R)$ be the subgroup of the q -fold tensor product of R^\times over \mathbb{Z} generated by the elements $a_1 \otimes \cdots \otimes a_q$, where a_1, \dots, a_q are elements of R^\times such that $a_i + a_j = 0$ or 1 for some $i \neq j$. Define

$$K_q^M(R) = (R^\times \otimes_{\mathbb{Z}} \cdots \otimes_{\mathbb{Z}} R^\times) / J(R).$$

We denote the image of $a_1 \otimes \cdots \otimes a_q$ by $\{a_1, \dots, a_q\}$.

Now we assume K is a discrete valuation field. Let v_K be the normalized valuation of K . Let \mathcal{O}_K , F and \mathfrak{m}_K be the valuation ring, the residue field and the valuation ideal of K , respectively. There is a natural filtration on K^\times defined by

$$U_K^i = \begin{cases} \mathcal{O}_K^\times & \text{for } i = 0 \\ 1 + \mathfrak{m}_K^i & \text{for } i \geq 1. \end{cases}$$

We know that the graded quotients U_K^i/U_K^{i+1} are isomorphic to F^\times if $i = 0$ and F if $i \geq 1$. Similarly, there is a natural filtration on $K_q^M(K)$ defined by

$$U^i K_q^M(K) = \left\{ \{x_1, \dots, x_q\} \in K_q^M(K) \mid x_1 \in U_K^i, x_2, \dots, x_q \in K^\times \right\}.$$

Let $\text{gr}^i K_q^M(K) = U^i K_q^M(K)/U^{i+1} K_q^M(K)$ for $i \geq 0$. $\text{gr}^i K_q^M(K)$ are determined in the case that the characteristics of K and F are both equal to 0 in [5], and in the case that they are both nonzero in [2] and [9]. If K is of mixed characteristics $(0, p)$, $\text{gr}^i K_q^M(K)$ is determined in [3] in the range $0 \leq i \leq e_K p/(p-1)$, where $e_K = v_K(p)$. However, $\text{gr}^i K_q^M(K)$ still remains mysterious for $i > ep/(p-1)$. In [16], Kurihara determined $\text{gr}^i K_q^M(K)$ for all i if K is absolutely unramified, i.e., $v_K(p) = 1$. In [13] and [19], $\text{gr}^i K_q^M(K)$ is determined for some K with absolute ramification index greater than one.

The purpose of this paper is to determine $\text{gr}^i K_q^M(K)$ for all i and a discrete valuation field K of mixed characteristics $(0, p)$, where p is an odd prime and $p \nmid e_K$. We do not assume F to be perfect. Note that the graded quotient $\text{gr}^i K_q^M(K)$ is equal to $\text{gr}^i K_q^M(\hat{K})$, where \hat{K} is the completion of K with respect to the valuation, thus we may assume that K is complete under the valuation.

Let F be a field of positive characteristic. Let $\Omega_F^1 = \Omega_{F/\mathbb{Z}}^1$ be the module of absolute differentials and Ω_F^q the q -th exterior power of Ω_F^1 over F . As in [7], we define the following subgroups of Ω_F^q . $Z_1^q = Z_1 \Omega_F^q$ denotes the kernel of $d : \Omega_F^q \rightarrow \Omega_F^{q+1}$ and $B_1^q = B_1 \Omega_F^q$ denotes the image of $d : \Omega_F^{q-1} \rightarrow \Omega_F^q$. Then there is an exact sequence

$$0 \longrightarrow B_1^q \longrightarrow Z_1^q \xrightarrow{C} \Omega_F^q \longrightarrow 0,$$

where C is the Cartier operator defined by

$$\begin{aligned} x^p \frac{dy_1}{y_1} \wedge \cdots \wedge \frac{dy_q}{y_q} &\longmapsto x \frac{dy_1}{y_1} \wedge \cdots \wedge \frac{dy_q}{y_q}, \\ B_1^q &\rightarrow 0. \end{aligned}$$

The inverse of C induces the isomorphism

$$\begin{aligned} C^{-1} : \Omega_F^q &\xrightarrow{\cong} Z_1^q/B_1^q \\ x \frac{dy_1}{y_1} \wedge \cdots \wedge \frac{dy_q}{y_q} &\longmapsto x^p \frac{dy_1}{y_1} \wedge \cdots \wedge \frac{dy_q}{y_q} \end{aligned} \tag{1}$$

for $x \in F$ and $y_1, \dots, y_q \in F^\times$. For $i \geq 2$, let $B_i^q = B_i \Omega_F^q$ (resp. $Z_i^q = Z_i \Omega_F^q$) be the subgroup of Ω_F^q defined inductively by

$$B_i^q \supset B_{i-1}^q, \quad C^{-1} : B_{i-1}^q \xrightarrow{\cong} B_i^q / B_1^q$$

$$(\text{resp. } Z_i^q \subset Z_{i-1}^q, \quad C^{-1} : Z_{i-1}^q \xrightarrow{\cong} Z_i^q / B_1^q).$$

Let Z_∞^q be the intersection of all Z_i^q for $i \geq 1$. We denote $Z_i^q = \Omega_F^q$ for $i \leq 0$.

The main result of this paper is the following

THEOREM 1.1. *Let K be a discrete valuation field of characteristic zero, and F the residue field of K . Assume that $p = \text{char}(F)$ is an odd prime and $e = e_K = v_K(p)$ is prime to p . For $i > ep/(p-1)$, let n be the maximal integer which satisfies $i - ne \geq e/(p-1)$ and let $s = v_p(i - ne)$, where v_p is the p -adic order. Then*

$$\text{gr}^i K_q^M(K) \cong \Omega_F^{q-1} / B_{s+n}^{q-1}.$$

COROLLARY 1.2. *Let $U^i(K_q^M(K)/p^m)$ be the image of $U^i K_q^M(K)$ in $K_q^M(K)/p^m K_q^M(K)$ for $m \geq 1$ and $\text{gr}^i(K_q^M(K)/p^m) = U^i(K_q^M(K)/p^m)/U^{i+1}(K_q^M(K)/p^m)$. Then*

$$\text{gr}^i(K_q^M(K)/p^m) \cong \begin{cases} \Omega_F^{q-1} / B_{s+n}^{q-1} & (\text{if } m > s+n) \\ \Omega_F^{q-1} / Z_{m-n}^{q-1} & (\text{if } m \leq s+n, i - en \neq \frac{e}{p-1}) \\ \Omega_F^{q-1} / (1 + aC)Z_{m-n+1}^{q-1} & (\text{if } m \leq s+n, i - en = \frac{e}{p-1}) \end{cases}$$

where a is the residue class of p/π^e for a fixed prime element π of K .

Remark 1.3. If $0 \leq i \leq ep/(p-1)$, $\text{gr}^i K_q^M(K)$ is known by [3].

To show (1.1), we use the (truncated) syntomic complexes with respect to \mathcal{O}_K and $\mathcal{O}_K/p\mathcal{O}_K$, which were introduced in [11]. In [12], it was proved that there exists an isomorphism between some subgroup of the q -th cohomology group of the syntomic complex with respect to \mathcal{O}_K and some subgroup of $K_q^M(K)^\wedge$ which includes the image of $U^1 K_q^M(K)$ (cf. (2.1)). On the other hand, the cohomology groups of the syntomic complex with respect to $\mathcal{O}_K/p\mathcal{O}_K$ can be calculated easily because $\mathcal{O}_K/p\mathcal{O}_K$ depends only on F and e . Comparing these two complexes, we have the exact sequence (2.4)

$$H^1(\mathbb{S}_q) \longrightarrow \hat{\Omega}_{A/\mathbb{Z}}^{q-1} / p d \hat{\Omega}_{A/\mathbb{Z}}^{q-2} \xrightarrow{\text{exp}_p} K_q^M(K)^\wedge$$

as an long exact sequence of syntomic complexes, where \mathbb{S}_q is the truncated translated syntomic complex with respect to $\mathcal{O}_K/p\mathcal{O}_K$, hat means the p -adic completion, and exp_p is the Kurihara's K_q^M -exponential homomorphism with respect to p . For more details, see Section 2. The left hand side of this exact sequence is determined in (2.6), and we have (1.1) by calculating these groups and the relations explicitly.

In Section 2, we see the relations between the syntomic complexes mentioned above, the Milnor K -groups, and the differential modules. The method of the proof of (1.1) is mentioned here. Note that we do not assume $p \nmid e$ in this section and we get the explicit description of the cohomology group of the syntomic complex with respect to $\mathcal{O}_K/p\mathcal{O}_K$ which was used in the proof of (1.1) without the assumption $p \nmid e$. In Section 3, we calculate differential module of \mathcal{O}_K . We calculate the kernel of the K_q^M -exponential homomorphism (4) explicitly in Section 4, 5, 6 and 7. In Section 8, we show Theorem 1.1 and Corollary 1.2. In Section 9, we have an application related to higher local class field theory.

Notations and Definitions. All rings are commutative with 1. For an element x of a discrete valuation ring, \bar{x} means the residue class of x in the residue field. For an abelian group M and positive integer n , we denote $M/p^n = M/p^n M$ and $\hat{M} = \varprojlim_n M/p^n$. For a subset N of M , $\langle N \rangle$ means the subgroup of M generated by N . For a ring R , let $\Omega_R^1 = \Omega_{R/\mathbb{Z}}^1$ be the absolute differentials of R and Ω_R^q the q -th exterior power of Ω_R^1 over R for $q \geq 2$. We denote $\Omega_R^0 = R$ and $\Omega_R^q = 0$ for negative q . If R is of characteristic zero, let

$$\mathfrak{Z}_n \hat{\Omega}_R^q = \text{Ker} \left(\hat{\Omega}_R^q \xrightarrow{d} \hat{\Omega}_R^{q+1}/p^n \right)$$

for positive n . For an element $\omega \in \hat{\Omega}_R^q$, let $v_p(\omega)$ be the maximal n which satisfies $\omega \in \mathfrak{Z}_n \hat{\Omega}_R^q$. For $n \leq 0$, let $\mathfrak{Z}_n \hat{\Omega}_R^q = \hat{\Omega}_R^q$. Let $\mathfrak{Z}_\infty \hat{\Omega}_R^q$ be the intersection of $\mathfrak{Z}_n \hat{\Omega}_R^q$ of all $n \geq 0$. All complexes are cochain complexes. For a morphism of non-negative complexes $f: C \rightarrow D$, $[f: C \rightarrow D]$ and

$$\left[\begin{array}{ccccccc} C^0 & \xrightarrow{d} & C^1 & \xrightarrow{d} & C^2 & \xrightarrow{d} & \dots \\ \downarrow f & & \downarrow f & & \downarrow f & & \\ D^0 & \xrightarrow{d} & D^1 & \xrightarrow{d} & D^2 & \xrightarrow{d} & \dots \end{array} \right]$$

both denote the mapping fiber complex with respect to the morphism f , namely, the complex

$$(C^0 \xrightarrow{d} C^1 \oplus D^0 \xrightarrow{d} C^2 \oplus D^1 \xrightarrow{d} \dots),$$

where the leftmost term is the degree-0 part and where the differentials are defined by

$$\begin{aligned} C^i \oplus D^{i-1} &\longrightarrow C^{i+1} \oplus D^i \\ (a, b) &\longmapsto (da, f(a) - db). \end{aligned}$$

Acknowledgements. I would like to express my gratitude to Professor Kazuya Kato, Professor Masato Kurihara and Professor Ivan Fesenko for their valuable advice. I also wish to thank Takao Yamazaki for many helpful comments.

In [20], I.Zhukov calculated the Milnor K -groups of multidimensional complete fields in a different way. He gives an explicit description by using topological generators. In [8], B.Kahn also calculated $K_2(K)$ of local fields with perfect residue fields without an assumption $p \nmid e_K$.

2 EXPONENTIAL HOMOMORPHISM AND SYNTOMIC COHOMOLOGY

Let K be a complete discrete valuation field of mixed characteristics $(0, p)$. Assume that p is an odd prime. Let $A = \mathcal{O}_K$ be the ring of integers of K and F the residue field of K . Let A_0 be the Cohen subring of A with respect to F , namely, A_0 is a complete discrete valuation ring under the restriction of the valuation of A with the residue field F and p is a prime element of A_0 (cf. [4], IX, Section 2). Let K_0 be the fraction field of A_0 . Then K/K_0 is finite and totally ramified extension of extension degree $e = e_K$. We denote $e' = ep/(p - 1)$. Let π be a prime element of K and fix it. We further assume that F has a finite p -base and fix their liftings $\mathbb{T} \subset A_0$. We can take the Frobenius endomorphism f of A_0 such that $f(T) = T^p$ for $T \in \mathbb{T}$ (cf. [12] or [17]). Let $U^i K_q^M(A)$ be the subgroup defined by the same way of $U^i K_q^M(K)$, namely,

$$U^i K_q^M(A) = \left\langle \{x_1, \dots, x_q\} \in K_q^M(A) \mid x_1 \in U_K^i, x_2, \dots, x_q \in A^\times \right\rangle.$$

Let $U^i K_q^M(K)^\wedge$ (resp. $U^i K_q^M(A)^\wedge$) be the closure of the image of $U^i K_q^M(K)$ (resp. $U^i K_q^M(A)$) in $K_q^M(K)^\wedge$ (resp. $K_q^M(A)^\wedge$). Note that $\text{gr}^i K_q^M(K) \cong \text{gr}^i K_q^M(K)^\wedge$ for $i > 0$.

At first, we introduce an isomorphism between $U^1 K_q^M(K)^\wedge$ and a subgroup of the cohomology group of the syntomic complex with respect to A . For further details, see [12]. Let $B = A_0[[X]]$, where X is an indeterminate. We extend the operation of the Frobenius f on B by $f(X) = X^p$. We define \mathcal{I} and \mathcal{J} as follows.

$$\begin{aligned} \mathcal{J} &= \text{Ker} \left(B \xrightarrow{X \mapsto \pi} A \right) \\ \mathcal{I} &= \text{Ker} \left(B \xrightarrow{X \mapsto \pi} A \xrightarrow{\text{mod } p} A/p \right) = \mathcal{J} + pB. \end{aligned}$$

Let D and $J \subset D$ be the PD-envelope and the PD-ideal with respect to $B \rightarrow A$, respectively ([1], Section 3). Let $I \subset D$ be the PD-ideal with respect to $B \rightarrow A/p$. D is also the PD-envelope with respect to $B \rightarrow A/p$. Let $J^{[q]}$ and $I^{[q]}$ be their q -th divided powers. Notice that $I^{[1]} = I$, $J^{[1]} = J$ and $I^{[0]} = J^{[0]} = D$. If q is a negative integer, we denote $J^{[q]} = I^{[q]} = D$. We define the complexes $\mathbb{J}^{[q]}$ and $\mathbb{I}^{[q]}$ as

$$\begin{aligned} \mathbb{J}^{[q]} &= \left(J^{[q]} \xrightarrow{d} J^{[q-1]} \otimes_B \hat{\Omega}_B^1 \xrightarrow{d} J^{[q-2]} \otimes_B \hat{\Omega}_B^2 \longrightarrow \dots \right) \\ \mathbb{I}^{[q]} &= \left(I^{[q]} \xrightarrow{d} I^{[q-1]} \otimes_B \hat{\Omega}_B^1 \xrightarrow{d} I^{[q-2]} \otimes_B \hat{\Omega}_B^2 \longrightarrow \dots \right), \end{aligned}$$

where $\hat{\Omega}_B^q$ is the p -adic completion of Ω_B^q . The leftmost term of each complex is the degree 0 part. We define $\mathbb{D} = \mathbb{I}^{[0]} = \mathbb{J}^{[0]}$. For $1 \leq q < p$, let $\mathcal{S}(A, B)(q)$ and $\mathcal{S}'(A, B)(q)$ be the mapping fibers of

$$\begin{aligned} \mathbb{J}^{[q]} &\xrightarrow{1-f_q} \mathbb{D} \\ \mathbb{I}^{[q]} &\xrightarrow{1-f_q} \mathbb{D}, \end{aligned}$$

respectively, where $f_q = f/p^q$. $\mathcal{S}(A, B)(q)$ is called the syntomic complex of A with respect to B , and $\mathcal{S}'(A, B)(q)$ is also called the syntomic complex of A/p with respect to B (cf. [11]). We notice that

$$\begin{aligned}
 H^q(\mathcal{S}(A, B)(q)) &= \frac{\text{Ker} \left((D \otimes \hat{\Omega}_B^q) \oplus (D \otimes \hat{\Omega}_B^{q-1}) \rightarrow (D \otimes \hat{\Omega}_B^{q+1}) \oplus (D \otimes \hat{\Omega}_B^q) \right)}{\text{Im} \left((J \otimes \hat{\Omega}_B^{q-1}) \oplus (D \otimes \hat{\Omega}_B^{q-2}) \rightarrow (D \otimes \hat{\Omega}_B^q) \oplus (D \otimes \hat{\Omega}_B^{q-1}) \right)}, \tag{2}
 \end{aligned}$$

where the maps are the differentials of the mapping fiber. If $q \geq p$, we cannot define the map $1 - f_q$ on $\mathbb{J}^{[q]}$ and $\mathbb{I}^{[q]}$, but we define $H^q(\mathcal{S}(A, B)(q))$ by using (2) in this case. This is equal to the cohomology of the mapping fiber of

$$\sigma_{>q-3} \mathbb{J}^{[q]} \xrightarrow{1-f_q} \sigma_{>q-3} \mathbb{D},$$

where $\sigma_{>n} C^\cdot$ means the brutal truncation for a complex C^\cdot , i.e., $(\sigma_{>n} C^\cdot)^i$ is C^i if $i > n$ and 0 if $i \leq n$. Let $U^1(D \otimes \hat{\Omega}_B^{q-1})$ be the subgroup of $D \otimes \hat{\Omega}_B^{q-1}$ generated by $XD \otimes \hat{\Omega}_B^{q-1}$, $(X^e)^{[m]} D \otimes \hat{\Omega}_B^{q-1}$ for all $m \geq 1$ and $D \otimes \hat{\Omega}_B^{q-2} \wedge dX$. Let $U^1 H^q(\mathcal{S}(A, B)(q))$ be the subgroup of $H^q(\mathcal{S}(A, B)(q))$ generated by the image of $(D \otimes \hat{\Omega}_B^q) \oplus U^1(D \otimes \hat{\Omega}_B^{q-1})$. Then there is a result of Kurihara:

THEOREM 2.1 (KURIHARA, [12]). *A and B are as above. Then*

$$U^1 H^q(\mathcal{S}(A, B)(q)) \cong U^1 K_q^M(A)^\wedge.$$

Furthermore, we have the following

LEMMA 2.2. *A and K are as above. Assume that A has the primitive p-th roots of unity. Then*

- (i) *The natural map $K_q^M(A)^\wedge \rightarrow K_q^M(K)^\wedge$ is an injection.*
- (ii) $U^1 H^q(\mathcal{S}(A, B)(q)) \cong U^1 K_q^M(A)^\wedge \cong U^1 K_q^M(K)^\wedge$.

Remark 2.3. When F is separably closed, this lemma is also the consequence of the result of Kurihara [14]. But even if F is not separably closed, calculation goes similarly to [14].

Proof of Lemma 2.2. The first isomorphism of (ii) is (2.1). The natural map

$$U^1 K_q^M(A)^\wedge \rightarrow U^1 K_q^M(K)^\wedge$$

is a surjection by the definition of the filtrations and the fact that we can define an element $\{1 + \pi^i a_1, a_2, \dots, a_{q-1}, \pi\}$ as an element of $K_q^M(A)^\wedge$ by using Dennis-Stain Symbols, see [17]. Thus we only have to show (i). Let ζ_p be a primitive

p -th root of unity and fix it. Let μ_p be the subgroup of A^\times generated by ζ_p . For $n \geq 2$, see the following commutative diagram.

$$\begin{array}{ccccc}
 K_{q-1}^M(K)/p & \xrightarrow{\{*, \zeta_p\}} & K_q^M(A)/p^{n-1} & \xrightarrow{p} & K_q^M(A)/p^n \\
 = \downarrow & & \downarrow & & \downarrow \\
 K_{q-1}^M(K)/p & \xrightarrow{\{*, \zeta_p\}} & K_q^M(K)/p^{n-1} & \xrightarrow{p} & K_q^M(K)/p^n \\
 & & \longrightarrow & K_q^M(A)/p & \longrightarrow 0 \\
 & & & \downarrow & \\
 & & & \longrightarrow & K_q^M(K)/p \longrightarrow 0.
 \end{array} \tag{3}$$

The bottom row are exact by using Galois cohomology long exact sequence with respect to the Bockstein

$$\dots \rightarrow H^{q-1}(K, \mathbb{Z}/p(q)) \rightarrow H^q(K, \mathbb{Z}/p^{n-1}(q)) \rightarrow H^q(K, \mathbb{Z}/p^n(q)) \rightarrow \dots$$

and

$$K_q^M(K)/p^n \cong H^q(K, \mathbb{Z}/p^n(q))$$

by [3]. The map $\{*, \zeta_p\}$ in the top row is well-defined if $K_q^M(A)/p^{n-1} \rightarrow K_q^M(K)/p^{n-1}$ is injective, and the top row are exact except at $K_q^M(A)/p^{n-1}$. Using the induction on n , we only have to show the injectivity of $K_q^M(A)/p \rightarrow K_q^M(K)/p$. We know the subquotients of the filtration of $K_q^M(K)/p$ by [3] and we also know the subquotients of the filtration of $K_q^M(A)/p$ using the isomorphism $U^1 H^q(\mathcal{S}(A, B)(q)) \cong U^1 K_q^M(A)$ in [12] and the explicit calculation of $H^q(\mathcal{S}(A, B)(q))$ by [14] except $\text{gr}^0(K_q^M(A)/p)$. Natural map preserves filtrations and induces isomorphisms of subquotients. Thus $U^1(K_q^M(A)/p) \rightarrow U^1(K_q^M(K)/p)$ is an injection. Lastly, the composite map of the natural maps

$$K_q^M(F)/p \rightarrow \text{gr}^0(K_q^M(A)/p) \rightarrow \text{gr}^0(K_q^M(K)/p) \xrightarrow{\cong} K_q^M(F)/p \oplus K_{q-1}^M(F)/p$$

is also an injection. Hence $K_q^M(A)/p \rightarrow K_q^M(K)/p$ is injective. □

Next, we introduce K_q^M -exponential homomorphism and consider the kernel. By [17], there is the K_q^M -exponential homomorphism with respect to η for $q \geq 2$ and $\eta \in K$ such that $v_K(\eta) \geq 2e/(p-1)$ defined by

$$\begin{aligned}
 \exp_\eta & : \hat{\Omega}_A^{q-1} \longrightarrow K_q^M(K)^\wedge \\
 a \frac{db_1}{b_1} \wedge \dots \wedge \frac{db_{q-1}}{b_{q-1}} & \longmapsto \{\exp(\eta a), b_1, \dots, b_{q-1}\}
 \end{aligned} \tag{4}$$

for $a \in A, b_1, \dots, b_{q-1} \in A^\times$. Here \exp is

$$\exp(X) = \sum_{n=0}^{\infty} \frac{X^n}{n!}.$$

We use this K_q^M -exponential homomorphism only in the case $\eta = p$ in this paper. On the other hand, there exists an exact sequence of complexes

$$0 \rightarrow \begin{bmatrix} \sigma_{>q-3}\mathbb{J}^{[q]} \\ \downarrow 1-f_q \\ \sigma_{>q-3}\mathbb{D} \end{bmatrix} \rightarrow \begin{bmatrix} \sigma_{>q-3}\mathbb{I}^{[q]} \\ \downarrow 1-f_q \\ \sigma_{>q-3}\mathbb{D} \end{bmatrix} \rightarrow \begin{bmatrix} \sigma_{>q-3}\mathbb{I}^{[q]}/\sigma_{>q-3}\mathbb{J}^{[q]} \\ \downarrow \\ 0 \end{bmatrix} \rightarrow 0. \quad (5)$$

$[\sigma_{>q-3}\mathbb{I}^{[q]}/\sigma_{>q-3}\mathbb{J}^{[q]} \rightarrow 0]$ is none other than the complex $\sigma_{>q-3}\mathbb{I}^{[q]}/\sigma_{>q-3}\mathbb{J}^{[q]}$.

We denote the complex $[\sigma_{>q-3}\mathbb{I}^{[q]} \xrightarrow{1-f_q} \sigma_{>q-3}\mathbb{D}][q-2]$ by \mathbb{S}_q . It is the mapping fiber complex

$$\begin{bmatrix} I^{[2]} \otimes \hat{\Omega}_B^{q-2} & \xrightarrow{d} & I \otimes \hat{\Omega}_B^{q-1} & \xrightarrow{d} & D \otimes \hat{\Omega}_B^q & \xrightarrow{d} & \dots \\ \downarrow 1-f_q & & \downarrow 1-f_q & & \downarrow 1-f_q & & \\ D \otimes \hat{\Omega}_B^{q-2} & \xrightarrow{d} & D \otimes \hat{\Omega}_B^{q-1} & \xrightarrow{d} & D \otimes \hat{\Omega}_B^q & \xrightarrow{d} & \dots \end{bmatrix}. \quad (6)$$

Taking cohomology, we have the following

PROPOSITION 2.4. *A, B and K are as above. Then K_q^M -exponential homomorphism with respect to p factors through $\hat{\Omega}_A^{q-1}/pd\hat{\Omega}_A^{q-2}$ and there is an exact sequence*

$$H^1(\mathbb{S}_q) \xrightarrow{\psi} \hat{\Omega}_A^{q-1}/pd\hat{\Omega}_A^{q-2} \xrightarrow{\text{exp}_p} K_q^M(K).$$

Proof. See the cohomological long exact sequence with respect to the exact sequence (5). The q -th cohomology group of the left complex of (5) is equal to $H^q(\mathcal{S}(A, B)(q))$, thus the sequence

$$H^1(\mathbb{S}_q) \xrightarrow{\psi} H^1((\sigma_{>q-3}\mathbb{I}^{[q]}/\sigma_{>q-3}\mathbb{J}^{[q]}[q-2]) \rightarrow H^q(\mathcal{S}(A, B)(q))$$

is exact. Here we denote the first map by ψ . The complex $(\sigma_{>q-3}\mathbb{I}^{[2]}/\sigma_{>q-3}\mathbb{J}^{[2]}[q-2])$ is

$$\left((I^{[2]} \otimes \hat{\Omega}_B^{q-2}) / (J^{[2]} \otimes \hat{\Omega}_B^{q-2}) \rightarrow (I \otimes \hat{\Omega}_B^{q-1}) / (J \otimes \hat{\Omega}_B^{q-1}) \rightarrow 0 \rightarrow \dots \right).$$

$(I \otimes \hat{\Omega}_B^{q-1}) / (J \otimes \hat{\Omega}_B^{q-1})$ is the subgroup of $(D \otimes \hat{\Omega}_B^{q-1}) / (J \otimes \hat{\Omega}_B^{q-1}) = A \otimes \hat{\Omega}_B^{q-1}$. The image of $I \otimes \hat{\Omega}_B^{q-1}$ in $A \otimes \hat{\Omega}_B^{q-1}$ is equal to $pA \otimes \hat{\Omega}_B^{q-1}$. Thus $(I \otimes \hat{\Omega}_B^{q-1}) / (J \otimes \hat{\Omega}_B^{q-1}) = pA \otimes \hat{\Omega}_B^{q-1}$. The image of

$$(I^{[2]} \otimes \hat{\Omega}_B^{q-2}) / (J^{[2]} \otimes \hat{\Omega}_B^{q-2}) \xrightarrow{d} pA \otimes \hat{\Omega}_B^{q-1}$$

is equal to the image of $\mathcal{I}^2 \otimes \hat{\Omega}_B^{q-2}$. By $\mathcal{I} = (p) + \mathcal{J}$, $d(\mathcal{I}^2 \otimes \hat{\Omega}_B^{q-2})$ is equal to $d(\mathcal{J}^2 \otimes \hat{\Omega}_B^{q-2}) + pd(\mathcal{J} \otimes \hat{\Omega}_B^{q-2}) + p^2d(\hat{\Omega}_B^{q-2})$. By the exact sequence

$$0 \longrightarrow \mathcal{J} \longrightarrow B \longrightarrow A \longrightarrow 0,$$

we have an exact sequence

$$(\mathcal{J}/\mathcal{J}^2) \otimes \hat{\Omega}_B^{q-2} \xrightarrow{d} A \otimes \hat{\Omega}_B^{q-1} \longrightarrow \hat{\Omega}_A^{q-1} \longrightarrow 0. \tag{7}$$

Thus the image of $d(\mathcal{J}^2 \otimes \hat{\Omega}_B^{q-2})$ in $A \otimes \hat{\Omega}_B^{q-1}$ is zero. $A \otimes \hat{\Omega}_B^{q-1}$ is torsion free, thus

$$\frac{pA \otimes \hat{\Omega}_B^{q-1}}{pd(\mathcal{J} \otimes \hat{\Omega}_B^{q-2}) + p^2d\hat{\Omega}_B^{q-2}} \xrightarrow{p^{-1}} \frac{A \otimes \hat{\Omega}_B^{q-1}}{d(\mathcal{J} \otimes \hat{\Omega}_B^{q-2}) + pd\hat{\Omega}_B^{q-2}} \cong \hat{\Omega}_A^{q-1}/pd\hat{\Omega}_A^{q-2}. \tag{8}$$

Hence we have $H^1((\sigma_{>q-3}\mathbb{I}^{[2]}/\sigma_{>q-3}\mathbb{J}^{[2]})[q-2]) \cong \hat{\Omega}_A^{q-1}/pd\hat{\Omega}_A^{q-2}$. By chasing the connecting homomorphism $\hat{\Omega}_A^{q-1}/pd\hat{\Omega}_A^{q-2} \rightarrow H^q(\mathcal{S}(A, B)(q))$, we can show that the image is contained by $U^1H^q(\mathcal{S}(A, B)(q))$ and the composite map

$$\hat{\Omega}_A^{q-1} \rightarrow \hat{\Omega}_A^{q-1}/pd\hat{\Omega}_A^{q-2} \rightarrow U^1H^q(\mathcal{S}(A, B)(q)) \xrightarrow{\cong} U^1K_q^M(K)^\wedge$$

is equal to \exp_p . We got the desired exact sequence. □

Remark 2.5. By [3], there exist surjections

$$\begin{aligned} \Omega_F^{q-2} \oplus \Omega_F^{q-1} &\longrightarrow \text{gr}^i K_q^M(K) \\ \left(x \frac{dy_1}{y_1} \wedge \cdots \wedge \frac{dy_{q-2}}{f_{q-2}}, 0\right) &\longmapsto \{1 + \pi^i \tilde{x}, \tilde{y}_1, \dots, \tilde{y}_{q-2}, \pi\} \\ \left(0, x \frac{dy_1}{y_1} \wedge \cdots \wedge \frac{dy_{q-1}}{f_{q-1}}\right) &\longmapsto \{1 + \pi^i \tilde{x}, \tilde{y}_1, \dots, \tilde{y}_{q-1}\} \end{aligned} \tag{9}$$

for $i \geq 1$, where $x \in F$, $y_1, \dots, y_{q-1} \in F^\times$ and where $\tilde{x}, \tilde{y}_1, \dots, \tilde{y}_{q-1}$ are their liftings to A . If $i \geq e + 1$, then we can construct all elements of $\text{gr}^i K_q^M(K)$ as the image of \exp_p , namely,

$$\begin{aligned} \left\{ \omega \in \hat{\Omega}_A^{q-1}/pd\hat{\Omega}_A^{q-2} \mid \exp_p(\omega) \in U^i K_q^M(K)^\wedge \right\} &\xrightarrow{\exp_p} \text{gr}^i K_q^M(K) \\ \frac{\pi^{i-1}}{p} a \frac{db_1}{b_1} \wedge \cdots \wedge \frac{db_{q-2}}{b_{q-2}} \wedge d\pi &\longmapsto \{\exp(\pi^i a), b_1, \dots, b_{q-2}, \pi\} \\ &= \{1 + \pi^i a, b_1, \dots, b_{q-2}, \pi\} \\ \frac{\pi^i}{p} a \frac{db_1}{b_1} \wedge \cdots \wedge \frac{db_{q-1}}{b_{q-1}} &\longmapsto \{\exp(\pi^i a), b_1, \dots, b_{q-1}\} \\ &= \{1 + \pi^i a, b_1, \dots, b_{q-1}\}. \end{aligned}$$

Thus $U^{e+1}K_q^M(K)^\wedge$ is contained by the image of \exp_p . On the other hand, (2.4) says the kernel of the K_q^M -exponential homomorphism is $\psi(H^1(\mathbb{S}_q))$. Recall that the aim of this paper is to determine $\text{gr}^i K_q^M(K)$ for all i , but we already know them in the range $0 \leq i \leq e'$ in [3]. Thus if we want to know $\text{gr}^i K_q^M(K)$ for all i , we only have to know $\psi(H^1(\mathbb{S}_q))$. We determine $H^1(\mathbb{S}_q)$ in the rest of this section, and $\psi(H^1(\mathbb{S}_q))$ in Section 4, 5, 6 and 7.

To determine $H^1(\mathbb{S}_q)$, we introduce a filtration into it. Let $0 \leq r < p$ and $s \geq 0$ be integers. Recall that $B = A_0[[X]]$. For $i \geq 0$ and $s \geq 0$, let $\text{fil}^i(I^{[r]} \otimes \hat{\Omega}_B^s)$ be the subgroup of $I^{[r]} \otimes \hat{\Omega}_B^s$ generated by the elements

$$\begin{aligned} & \left\{ X^n (X^e)^{[j]} \omega \mid n + ej \geq i, n \geq 0, j \geq r, \omega \in D \otimes \hat{\Omega}_B^s \right\} \\ & \cup \left\{ X^{n-1} (X^e)^{[j]} \omega \wedge dX \mid n + ej \geq i, n \geq 1, j \geq r, \omega \in D \otimes \hat{\Omega}_B^{s-1} \right\}. \end{aligned}$$

The homomorphism $1 - f_{r+s} : I^{[r]} \otimes \hat{\Omega}_B^s \rightarrow D \otimes \hat{\Omega}_B^s$ preserves filtrations. Thus we can define the following complexes

$$\begin{aligned} & \text{fil}^i(\sigma_{>q-3}\mathbb{I}^{[q]})[q-2] \\ & \quad = (\text{fil}^i(I^{[2]} \otimes \hat{\Omega}_B^{q-2}) \rightarrow \text{fil}^i(I \otimes \hat{\Omega}_B^{q-1}) \rightarrow \text{fil}^i(D \otimes \hat{\Omega}_B^q) \rightarrow \dots) \\ & \text{fil}^i(\sigma_{>q-3}\mathbb{D})[q-2] \\ & \quad = (\text{fil}^i(D \otimes \hat{\Omega}_B^{q-2}) \rightarrow \text{fil}^i(D \otimes \hat{\Omega}_B^{q-1}) \rightarrow \text{fil}^i(D \otimes \hat{\Omega}_B^q) \rightarrow \dots) \\ & \text{fil}^i \mathbb{S}_q = \left[\text{fil}^i(\sigma_{>q-3}\mathbb{I}^{[q]})[q-2] \xrightarrow{1-f_q} \text{fil}^i(\sigma_{>q-3}\mathbb{D})[q-2] \right] \\ & \text{gr}^i(\sigma_{>q-3}\mathbb{I}^{[r]})[q-2] = \frac{\text{fil}^i(\sigma_{>q-3}\mathbb{I}^{[r]})[q-2]}{\text{fil}^{i+1}(\sigma_{>q-3}\mathbb{I}^{[r]})[q-2]} \quad \text{for } r = 0, q \\ & \text{gr}^i \mathbb{S}_q = \left[\text{gr}^i(\sigma_{>q-3}\mathbb{I}^{[q]})[q-2] \xrightarrow{1-f_q} \text{gr}^i(\sigma_{>q-3}\mathbb{D})[q-2] \right]. \end{aligned}$$

Note that if $i \geq 1$, $1 - f_q : \text{gr}^i(\sigma_{>q-3}\mathbb{I}^{[q]})[q-2] \rightarrow \text{gr}^i(\sigma_{>q-3}\mathbb{D})[q-2]$ is none other than 1 because f_q takes the elements to the higher filters. $\text{fil}^i \mathbb{S}_q$ forms the filtration of \mathbb{S}_q and we have the exact sequences

$$0 \longrightarrow \text{fil}^{i+1} \mathbb{S}_q \longrightarrow \text{fil}^i \mathbb{S}_q \longrightarrow \text{gr}^i \mathbb{S}_q \longrightarrow 0$$

for $i \geq 0$. This exact sequence of complexes give a long exact sequence

$$\dots \rightarrow H^n(\text{fil}^{i+1} \mathbb{S}_q) \rightarrow H^n(\text{fil}^i \mathbb{S}_q) \rightarrow H^n(\text{gr}^i \mathbb{S}_q) \rightarrow H^{n+1}(\text{fil}^{i+1} \mathbb{S}_q) \rightarrow \dots \quad (10)$$

Furthermore, we have the following

PROPOSITION 2.6. $\{H^1(\text{fil}^i \mathbb{S}_q)\}_i$ forms the finite decreasing filtration of $H^1(\mathbb{S}_q)$. Denote $\text{fil}^i H^1(\mathbb{S}_q) = H^1(\text{fil}^i \mathbb{S}_q)$ and $\text{gr}^i H^1(\mathbb{S}_q) = \text{fil}^i H^1(\mathbb{S}_q) / \text{fil}^{i+1} H^1(\mathbb{S}_q)$. Then

$$\text{gr}^i H^1(\mathbb{S}_q) = \begin{cases} 0 & (\text{if } i > 2e) \\ X^{2e-1} dX \wedge (\hat{\Omega}_{A_0}^{q-3}/p) & (\text{if } i = 2e) \\ X^i (\hat{\Omega}_{A_0}^{q-2}/p) \oplus X^{i-1} dX \wedge (\hat{\Omega}_{A_0}^{q-3}/p) & (\text{if } e < i < 2e) \\ X^e (\hat{\Omega}_{A_0}^{q-2}/p) \oplus X^{e-1} dX \wedge (\mathfrak{Z}_1 \hat{\Omega}_{A_0}^{q-3}/p^2 \hat{\Omega}_{A_0}^{q-3}) & (\text{if } i = e, p \mid e) \\ X^{e-1} dX \wedge (\mathfrak{Z}_1 \hat{\Omega}_{A_0}^{q-3}/p^2 \hat{\Omega}_{A_0}^{q-3}) & (\text{if } i = e, p \nmid e) \\ \left(X^i \frac{(p^{\text{Max}(\eta'_i - v_p(i), 0)} \hat{\Omega}_{A_0}^{q-2} \cap \mathfrak{Z}_{\eta_i} \hat{\Omega}_{A_0}^{q-2}) + p^2 \hat{\Omega}_{A_0}^{q-2})}{p^2 \hat{\Omega}_{A_0}^{q-2}} \right) & (\text{if } 1 \leq i < e) \\ \oplus \left(X^{i-1} dX \wedge \frac{\mathfrak{Z}_{\eta_i} \hat{\Omega}_{A_0}^{q-3} + p^2 \hat{\Omega}_{A_0}^{q-3}}{p^2 \hat{\Omega}_{A_0}^{q-3}} \right) & \\ 0 & (\text{if } i = 0), \end{cases}$$

where η_i and η'_i be the integers which satisfy $p^{n_i-1}i < e \leq p^{n_i}i$ and $p^{n_i-1}i - 1 < e \leq p^{n_i}i - 1$ for each i .

To prove (2.6), we need the following lemmas.

LEMMA 2.7. For $\omega \in D \otimes \hat{\Omega}_B^q$ and $n \geq 0$,

$$v_p(f^n(\omega)) \geq v_p(\omega) + nq. \tag{11}$$

In particular, if $\omega \in \hat{\Omega}_{A_0}^q$, then

$$v_p(f^n(\omega)) = v_p(\omega) + nq. \tag{12}$$

Proof. $\omega \in D \otimes \hat{\Omega}_B^q$ can be rewrite as $\omega = \sum_i a_i \omega_i$, where $a_i \in D$ and ω_i are the canonical generators of $\hat{\Omega}_B^q$, which are

$$\omega_i = \frac{dT_1}{T_1} \wedge \cdots \wedge \frac{dT_q}{T_q}$$

for $T_1, \dots, T_q \in \mathbb{T} \cup \{X\}$. Canonical generators have the property $f(\omega_i) = p^q \omega_i$, thus we have (11). Furthermore, if $\omega \in \hat{\Omega}_{A_0}^q$, then $a_i \in A_0$ and we have $v_p(f(a_i)) = v_p(a_i)$. Thus (12) follows. \square

LEMMA 2.8. If $1 \leq r < p$, $s \geq 0$ and $i > er$, then there exists a homomorphism

$$\sum_{m=0}^{\infty} f_{r+s}^m : \text{fil}^i(D \otimes \hat{\Omega}_B^s) \longrightarrow \text{fil}^i(I^{[r]} \otimes_B \hat{\Omega}_B^s)$$

This is the inverse map of $1 - f_{r+s}$, hence $1 - f_{r+s} : \text{fil}^i(I^{[r]} \otimes_B \hat{\Omega}_B^s) \rightarrow \text{fil}^i(D \otimes \hat{\Omega}_B^s)$ is an isomorphism.

Proof. By $i > er$, $\text{fil}^i(I^{[r]} \otimes \hat{\Omega}_B^s) = \text{fil}^i(D \otimes \hat{\Omega}_B^s)$ because $X^i = r!X^{i-er}(X^e)^{[r]}$. All elements of $\text{fil}^i D \otimes \hat{\Omega}_B^s$ can be written as the sum of the elements of the form $X^n(X^e)^{[j]}\omega$, where $\omega \in D \otimes \hat{\Omega}_B^s$ and $n + ej \geq i$. Now $r < p$, thus $(X^e)^{[r]} = X^{er}/r!$ in D , hence we may assume $j \geq r$. The image of $X^n(X^e)^{[j]}\omega$ is

$$\sum_{m=0}^{\infty} f_{r+s}^m(X^n(X^e)^{[j]}\omega) = \sum_{m=0}^{\infty} \frac{(p^m j)!}{p^{rm}(j!)} X^{np^m} (X^e)^{[p^m j]} \frac{f^m(\omega)}{p^{sm}}.$$

Here, $f^m(\omega)$ is divisible by p^{sm} by (11). The coefficients $(p^m j)!/p^{rm}(j!)$ are p -integers for all m and if $j \geq 1$ then the sum converges p -adically. If $j = r = 0$, $n \geq 1$ says that the order of the power of X is increasing. This also means the sum converges p -adically in $D \otimes_B \hat{\Omega}_B^s$. The image is in $\text{fil}^i(I^{[r]} \otimes_B \hat{\Omega}_B^s)$ because $p^m j \geq r$ for all m , thus the map is well-defined. Obviously, $\sum_{m=0}^{\infty} f_{r+s}^m$ is the inverse map of $1 - f_{r+s}$. \square

LEMMA 2.9. *Let $i \geq 1$ and $e \geq 1$ be integers. For each $n \geq 0$, let m_n (resp. m'_n) be the maximal integer which satisfies $ip^n \geq m_n e$ (resp. $ip^n - 1 \geq m'_n e$). Then*

$$\begin{aligned} & \text{Min} \{v_p(m_n!) + m_n - n\}_n \\ &= \begin{cases} 1 - \eta_i \leq 0 & (\text{when } n = \eta_i - 1, \text{ if } \eta_i \geq 1) \\ v_p(m_0!) + m_0 \geq 1 & (\text{when } n = 0, \text{ if } \eta_i = 0) \end{cases} \\ & \text{Min} \{v_p(m'_n!) + m'_n - n\}_n \\ &= \begin{cases} 1 - \eta'_i \leq 0 & (\text{when } n = \eta'_i - 1, \text{ if } \eta'_i \geq 1) \\ v_p(m'_0!) + m'_0 \geq 1 & (\text{when } n = 0, \text{ if } \eta'_i = 0), \end{cases} \end{aligned}$$

where η_i and η'_i are as in (2.6).

Proof. By the definition of $\{m_n\}_n$, m_{n+1} is greater than or equal to pm_n . Thus $v_p(m'_{n+1}!) \geq v_p(pm'_n!)$ and

$$\begin{aligned} & v_p(m_{n+1}!) + m_{n+1} - (n + 1) - (v_p(m_n!) + m_n - n) \\ &= v_p(m_{n+1}!) - v_p(m_n!) + m_{n+1} - m_n - 1 \end{aligned} \tag{13}$$

is greater than zero if $m_n > 0$. On the other hand, η_i is the number which has the property that if $n < \eta_i$, then $m_n = 0$ and $m_{\eta_i} \geq 1$. Thus the value of (13) is less than zero if and only if $n < \eta_i$. Hence the minimum of $v_p(m_n!) + m_n - n$ is the value when $n = \eta_i - 1$ if $\eta_i > 0$ and $n = 0$ if $\eta_i = 0$. The rest of the desired equation comes from the same way. \square

Proof of Proposition 2.6. At first, we show that $\{H^1(\text{fil}^i \mathbb{S}_q)\}_i$ forms the finite decreasing filtration of $H^1(\mathbb{S}_q)$. See

$$\text{gr}^i \mathbb{S}_q = \left[\begin{array}{ccccccc} \text{gr}^i I^{[2]} \otimes \hat{\Omega}_B^{q-2} & \xrightarrow{d} & \text{gr}^i I \otimes \hat{\Omega}_B^{q-1} & \xrightarrow{d} & \text{gr}^i D \otimes \hat{\Omega}_B^q & \xrightarrow{d} & \dots \\ \downarrow 1-f_q & & \downarrow 1-f_q & & \downarrow 1-f_q & & \\ \text{gr}^i D \otimes \hat{\Omega}_B^{q-2} & \xrightarrow{d} & \text{gr}^i D \otimes \hat{\Omega}_B^{q-1} & \xrightarrow{d} & \text{gr}^i D \otimes \hat{\Omega}_B^q & \xrightarrow{d} & \dots \end{array} \right]. \tag{14}$$

If $i \geq 1$, all vertical arrows of (14) are equal to 1. Thus they are injections by the definition of the filtration. Especially, the injectivity of the first vertical arrow gives $H^0(\text{gr}^i \mathbb{S}_q) = 0$, this means

$$0 \longrightarrow H^1(\text{fil}^{i+1} \mathbb{S}_q) \longrightarrow H^1(\text{fil}^i \mathbb{S}_q) \longrightarrow H^1(\text{gr}^i \mathbb{S}_q) \tag{15}$$

is exact. If $i = 0$, the first vertical arrow of (14) is $1 - f_q: p^2 \hat{\Omega}_{A_0}^{q-2} \rightarrow \hat{\Omega}_{A_0}^{q-2}$. This is also injective because of the invariance of the valuation of A_0 by the action of f . Thus the exact sequence (15) also follows when $i = 0$. Hence $\{H^1(\text{fil}^i \mathbb{S}_q)\}_i$ forms a decreasing filtration of $H^1(\mathbb{S}_q)$.

Next we calculate $H^1(\text{gr}^i \mathbb{S}_q)$. If $i > 2e$, $\text{fil}^i \mathbb{S}_q$ is acyclic by (2.8). Thus we only consider the case $i \leq 2e$. Furthermore, if $i \geq 1$, we may consider that $H^1(\text{gr}^i \mathbb{S}_q)$ is the subgroup of $\text{gr}^i D \otimes \hat{\Omega}_B^{q-2}$ because of the injectivity of the vertical arrows of (14).

Let $i = 2e$. Then $\text{gr}^{2e} \mathbb{S}_q$ is

$$\left[\begin{array}{ccccccc} X^{2e} \hat{\Omega}_{A_0}^{q-2} \oplus pX^{2e-1} dX \wedge \hat{\Omega}_{A_0}^{q-3} & \xrightarrow{d} & X^{2e} \hat{\Omega}_{A_0}^{q-1} \oplus X^{2e-1} dX \wedge \hat{\Omega}_{A_0}^{q-2} & \xrightarrow{d} & \dots \\ \downarrow 1 & & \downarrow 1 & & \\ X^{2e} \hat{\Omega}_{A_0}^{q-2} \oplus X^{2e-1} dX \wedge \hat{\Omega}_{A_0}^{q-3} & \xrightarrow{d} & X^{2e} \hat{\Omega}_{A_0}^{q-1} \oplus X^{2e-1} dX \wedge \hat{\Omega}_{A_0}^{q-2} & \xrightarrow{d} & \dots \end{array} \right].$$

The second vertical arrow is a surjection, thus

$$H^1(\text{gr}^{2e} \mathbb{S}_q) \cong X^{2e-1} dX \wedge (\hat{\Omega}_{A_0}^{q-3}/p). \tag{16}$$

Let $e < i < 2e$. Then $\text{gr}^{2e} \mathbb{S}_q$ is

$$\left[\begin{array}{ccccccc} pX^i \hat{\Omega}_{A_0}^{q-2} \oplus pX^{i-1} dX \wedge \hat{\Omega}_{A_0}^{q-3} & \xrightarrow{d} & X^i \hat{\Omega}_{A_0}^{q-1} \oplus X^{i-1} dX \wedge \hat{\Omega}_{A_0}^{q-2} & \xrightarrow{d} & \dots \\ \downarrow 1 & & \downarrow 1 & & \\ X^i \hat{\Omega}_{A_0}^{q-2} \oplus X^{i-1} dX \wedge \hat{\Omega}_{A_0}^{q-3} & \xrightarrow{d} & X^i \hat{\Omega}_{A_0}^{q-1} \oplus X^{i-1} dX \wedge \hat{\Omega}_{A_0}^{q-2} & \xrightarrow{d} & \dots \end{array} \right].$$

The second vertical arrow is also a surjection, thus

$$H^1(\text{gr}^i \mathbb{S}_q) \cong X^i (\hat{\Omega}_{A_0}^{q-2}/p) \oplus X^{i-1} dX \wedge (\hat{\Omega}_{A_0}^{q-3}/p). \tag{17}$$

Let $i = e$. Then $\text{gr}^e \mathbb{S}_q$ is

$$\left[\begin{array}{ccc} pX^e \hat{\Omega}_{A_0}^{q-2} \oplus p^2 X^{e-1} dX \wedge \hat{\Omega}_{A_0}^{q-3} & \xrightarrow{d} & X^e \hat{\Omega}_{A_0}^{q-1} \oplus pX^{e-1} dX \wedge \hat{\Omega}_{A_0}^{q-2} \xrightarrow{d} \dots \\ \downarrow 1 & & \downarrow 1 \\ X^e \hat{\Omega}_{A_0}^{q-2} \oplus X^{e-1} dX \wedge \hat{\Omega}_{A_0}^{q-3} & \xrightarrow{d} & X^e \hat{\Omega}_{A_0}^{q-1} \oplus X^{e-1} dX \wedge \hat{\Omega}_{A_0}^{q-2} \xrightarrow{d} \dots \end{array} \right].$$

The second vertical arrow is not a surjection. For an element $X^e \omega \in X^e \hat{\Omega}_{A_0}^{q-2}$, $d(X^e \omega)$ is included in $X^e \hat{\Omega}_{A_0}^{q-1} \oplus pX^{e-1} dX \wedge \hat{\Omega}_{A_0}^{q-2}$ if and only if $p \mid e$ or $p \mid \omega$. For an element $X^{e-1} \omega \wedge dX \in X^{e-1} dX \wedge \hat{\Omega}_{A_0}^{q-3}$, $d(X^{e-1} \omega \wedge dX)$ is included in $X^e \hat{\Omega}_{A_0}^{q-1} \oplus pX^{e-1} dX \wedge \hat{\Omega}_{A_0}^{q-2}$ if and only if $p \mid d\omega$. Thus we have

$$H^1(\text{gr}^e \mathbb{S}_q) \cong \begin{cases} X^e(\hat{\Omega}_{A_0}^{q-2}/p) \oplus X^{e-1} dX \wedge (\mathfrak{Z}_1 \hat{\Omega}_{A_0}^{q-3}/p^2 \hat{\Omega}_{A_0}^{q-3}) & (\text{if } p \mid e) \\ X^{e-1} dX \wedge (\mathfrak{Z}_1 \hat{\Omega}_{A_0}^{q-3}/p^2 \hat{\Omega}_{A_0}^{q-3}) & (\text{if } p \nmid e). \end{cases} \tag{18}$$

Let $1 \leq i < e$. Then $\text{gr}^i \mathbb{S}_q$ is

$$\left[\begin{array}{ccc} p^2 X^i \hat{\Omega}_{A_0}^{q-2} \oplus p^2 X^{i-1} dX \wedge \hat{\Omega}_{A_0}^{q-3} & \xrightarrow{d} & pX^i \hat{\Omega}_{A_0}^{q-1} \oplus pX^{i-1} dX \wedge \hat{\Omega}_{A_0}^{q-2} \xrightarrow{d} \dots \\ \downarrow 1 & & \downarrow 1 \\ X^i \hat{\Omega}_{A_0}^{q-2} \oplus X^{i-1} dX \wedge \hat{\Omega}_{A_0}^{q-3} & \xrightarrow{d} & X^i \hat{\Omega}_{A_0}^{q-1} \oplus X^{i-1} dX \wedge \hat{\Omega}_{A_0}^{q-2} \xrightarrow{d} \dots \end{array} \right].$$

The image of $X^i \omega \in X^i \hat{\Omega}_{A_0}^{q-2}$ is included in $pX^i \hat{\Omega}_{A_0}^{q-1} \oplus pX^{i-1} dX \wedge \hat{\Omega}_{A_0}^{q-2}$ if and only if $p \mid i\omega$ and $p \mid d\omega$, and the image of $X^{i-1} dX \wedge \omega \in X^{i-1} dX \wedge \hat{\Omega}_{A_0}^{q-3}$ is included in $pX^i \hat{\Omega}_{A_0}^{q-1} \oplus pX^{i-1} dX \wedge \hat{\Omega}_{A_0}^{q-2}$ if and only if $p \mid d\omega$. Thus

$$H^1(\text{gr}^i \mathbb{S}_q) \cong \begin{cases} X^i (\mathfrak{Z}_1 \hat{\Omega}_{A_0}^{q-2}/p^2 \hat{\Omega}_{A_0}^{q-2}) \oplus X^{i-1} dX \wedge (\mathfrak{Z}_1 \hat{\Omega}_{A_0}^{q-3}/p^2 \hat{\Omega}_{A_0}^{q-3}) & (\text{if } p \mid i) \\ X^i (p \hat{\Omega}_{A_0}^{q-2}/p^2 \hat{\Omega}_{A_0}^{q-2}) \oplus X^{i-1} dX \wedge (\mathfrak{Z}_1 \hat{\Omega}_{A_0}^{q-3}/p^2 \hat{\Omega}_{A_0}^{q-3}) & (\text{if } p \nmid i). \end{cases} \tag{19}$$

If $i = 0$, we need more calculation. The complex $\text{gr}^0 \mathbb{S}_q$ is

$$\left[\begin{array}{cccc} p^2 \hat{\Omega}_{A_0}^{q-2} & \xrightarrow{d} & p \hat{\Omega}_{A_0}^{q-1} & \xrightarrow{d} & \hat{\Omega}_{A_0}^q & \xrightarrow{d} & \dots \\ \downarrow 1-f_q & & \downarrow 1-f_q & & \downarrow 1-f_q & & \\ \hat{\Omega}_{A_0}^{q-2} & \xrightarrow{d} & \hat{\Omega}_{A_0}^{q-1} & \xrightarrow{d} & \hat{\Omega}_{A_0}^q & \xrightarrow{d} & \dots \end{array} \right].$$

We introduce a p -adic filtration to $\text{gr}^0 \mathbb{S}_q$ as follows.

$$\text{fil}_p^m(\text{gr}^0 \mathbb{S}_q) = \left[\begin{array}{cccc} p^{2+m} \hat{\Omega}_{A_0}^{q-2} & \xrightarrow{d} & p^{1+m} \hat{\Omega}_{A_0}^{q-1} & \xrightarrow{d} & p^m \hat{\Omega}_{A_0}^q & \xrightarrow{d} & \dots \\ \downarrow 1-f_q & & \downarrow 1-f_q & & \downarrow 1-f_q & & \\ p^m \hat{\Omega}_{A_0}^{q-2} & \xrightarrow{d} & p^m \hat{\Omega}_{A_0}^{q-1} & \xrightarrow{d} & p^m \hat{\Omega}_{A_0}^q & \xrightarrow{d} & \dots \end{array} \right].$$

Then, for all $m \geq 0$,

$$\mathrm{gr}_p^m(\mathrm{gr}^0 \mathbb{S}_q) = \begin{bmatrix} \Omega_F^{q-2} & \xrightarrow{0} & \Omega_F^{q-1} & \xrightarrow{0} & \Omega_F^q & \longrightarrow & \dots \\ \downarrow -C^{-1} & & \downarrow -C^{-1} & & \downarrow 1-C^{-1} & & \\ \Omega_F^{q-2} & \xrightarrow{d} & \Omega_F^{q-1} & \xrightarrow{d} & \Omega_F^q & \longrightarrow & \dots \end{bmatrix}. \quad (20)$$

The injectivity of the leftmost vertical arrow of (20) says that

$$H^0(\mathrm{gr}_p^m(\mathrm{gr}^0 \mathbb{S}_q)) = 0$$

for all $m \geq 0$. Thus $\{H^1(\mathrm{fil}_p^m(\mathrm{gr}^0 \mathbb{S}_q))\}_m$ is a decreasing filtration of $H^1(\mathrm{gr}^0 \mathbb{S}_q)$. On the other hand, the intersection of the image of $-C^{-1} : \Omega_F^{q-1} \rightarrow \Omega_F^{q-2}$ and the image of $d : \Omega_F^{q-2} \rightarrow \Omega_F^{q-1} = B_1^{q-1}$ is $\{0\}$ by (1). Thus we also have $H^1(\mathrm{gr}_p^m(\mathrm{gr}^0 \mathbb{S}_q)) = 0$ for all $m \geq 0$. Hence we have $H^1(\mathrm{gr}^0 \mathbb{S}_q) = 0$.

We already have known $H^1(\mathrm{gr}^i \mathbb{S}_q)$ for all $i \geq 0$, but the third arrow of (15) is not surjective in general. So we must know the image of $H^1(\mathrm{fil}^i \mathbb{S}_q) \rightarrow H^1(\mathrm{gr}^i \mathbb{S}_q)$. Let $i \geq 1$ and let x be an element of $\mathrm{fil}^i D \otimes \hat{\Omega}_B^{q-2}$ which represents an element of $H^1(\mathrm{gr}^i \mathbb{S}_q)$. $H^1(\mathrm{fil}^i \mathbb{S}_q)$ is

$$H^1 \begin{bmatrix} \mathrm{fil}^i I^{[2]} \otimes \hat{\Omega}_B^{q-2} & \xrightarrow{d} & \mathrm{fil}^i I \otimes \hat{\Omega}_B^{q-1} & \xrightarrow{d} & \mathrm{fil}^i D \otimes \hat{\Omega}_B^q & \xrightarrow{d} & \dots \\ \downarrow 1-f_q & & \downarrow 1-f_q & & \downarrow 1-f_q & & \\ \mathrm{fil}^i D \otimes \hat{\Omega}_B^{q-2} & \xrightarrow{d} & \mathrm{fil}^i D \otimes \hat{\Omega}_B^{q-1} & \xrightarrow{d} & \mathrm{fil}^i D \otimes \hat{\Omega}_B^q & \xrightarrow{d} & \dots \end{bmatrix}.$$

Now the second vertical arrow is an injection. Thus x also represents the element of $H^1(\mathrm{fil}^i \mathbb{S}_q)$ if and only if

$$\sum_{n=0}^{\infty} f_q^n(dx) \in \mathrm{fil}^i I \otimes \hat{\Omega}_B^{q-1}. \quad (21)$$

The elements of $H^1(\mathrm{gr}^i \mathbb{S}_q)$ are represented by two types of the elements of $D \otimes \hat{\Omega}_B^{q-2}$, these are $X^i \omega$ for $\omega \in \hat{\Omega}_{A_0}^{q-2}$ and $X^{i-1} dX \wedge \omega$ for $\omega \in \hat{\Omega}_{A_0}^{q-3}$. Thus we must know the condition when (21) follows for these elements.

At first, we calculate $X^i \omega$ for $\omega \in \hat{\Omega}_{A_0}^{q-2}$.

$$\begin{aligned} & \sum_{n=0}^{\infty} f_q^n(dX^i \omega) \\ &= \sum_{n=0}^{\infty} f_q^n(X^i d\omega + iX^{i-1} dX \wedge \omega) \\ &= \sum_{n=0}^{\infty} \left(\frac{1}{p^{nq}} X^{ip^n} f^n(d\omega) + \frac{ip^n}{p^{nq}} X^{ip^n-1} dX \wedge f^n(\omega) \right) \\ &= \sum_{n=0}^{\infty} \left(\frac{m_n!}{p^n} X^{ip^n-m_n e} (X^e)^{[m_n]} \frac{f^n(d\omega)}{p^{n(q-1)}} \right. \\ & \quad \left. + \frac{i(m_n!)}{p^n} X^{ip^n-1-m_n' e} (X^e)^{[m_n']} dX \wedge \frac{f^n(\omega)}{p^{n(q-2)}} \right). \end{aligned}$$

Here m_n and m'_n be the maximal integers which satisfy $ip^n - m_n e \geq 0$ and $ip^n - 1 - m'_n e \geq 0$. Note that $f^n(d\omega)$ and $f^n(\omega)$ can be divided by $p^{n(q-1)}$ and $p^{n(q-2)}$, respectively, by (11). Furthermore, $v_p(f^n(d\omega)/p^{n(q-1)}) = v_p(d\omega)$ and $v_p(f^n(\omega)/p^{n(q-2)}) = v_p(\omega)$ by (12). To be included in $I \otimes \hat{\Omega}_B^{q-1}$, the sum of the p -adic order and divided power degree must be greater than or equal to 1, i.e., $v_p(m_n!) - n + m_n + v_p(d\omega) \geq 1$ and $v_p(i) + v_p(m'_n!) - n + m'_n + v_p(\omega) \geq 1$ must be satisfied for all n . We already know the minimal of $v_p(m_n!) - n + m_n$ and $v_p(m'_n!) - n + m'_n$ by (2.9), thus $\sum_{n=0}^{\infty} f_q^n(dX^i \omega)$ belongs to $I \otimes_B^{q-1}$ if and only if

$$\begin{cases} \text{no condition} & (\text{if } e + 1 \leq i) \\ v_p(i) + v_p(\omega) \geq 1 & (\text{if } e = i) \\ v_p(d\omega) \geq \eta_i \text{ and } v_p(i) + v_p(\omega) \geq \eta'_i & (\text{if } 1 \leq i < e). \end{cases} \tag{22}$$

Next, we calculate $X^{i-1}dX \wedge \omega$ for $\omega \in \hat{\Omega}_{A_0}^{q-3}$.

$$\begin{aligned} & \sum_{n=0}^{\infty} f_q^n(dX^{i-1}dX \wedge \omega) \\ &= \sum_{n=0}^{\infty} f_q^n(X^{i-1}dX \wedge d\omega) \\ &= \sum_{n=0}^{\infty} \left(\frac{p^n}{p^{nq}} X^{ip^n-1} dX \wedge f^n(d\omega) \right) \\ &= \sum_{n=0}^{\infty} \left(\frac{(m'_n!)}{p^n} X^{ip^n-1-m'_n e} (X^e)^{[m'_n]} dX \wedge \frac{f^n(d\omega)}{p^{n(q-2)}} \right). \end{aligned}$$

To be included in $I \otimes \hat{\Omega}_B^{q-1}$, $v_p(m'_n!) - n + m'_n + v_p(d\omega) \geq 1$ must be satisfied for all n . As the same way as above, $\sum_{n=0}^{\infty} f_q^n(X^{i-1}dX \wedge \omega)$ belongs to $I \otimes_B^{q-1}$ if and only if

$$\begin{cases} \text{no condition} & (\text{if } e + 1 \leq i) \\ v_p(d\omega) \geq \eta'_i & (\text{if } 1 \leq i \leq e). \end{cases} \tag{23}$$

For $\omega \in \hat{\Omega}_{A_0}^{q-1}$, the condition $v_p(\omega) \geq n$ means $\omega \in p^n \hat{\Omega}_{A_0}^{q-1}$ and $v_p(d\omega) \geq n$ means $\omega \in \mathfrak{Z}_n \hat{\Omega}_{A_0}^{q-1}$. Thus, by (16), (17), (18), (19), (22) and (23), we get (2.6). \square

3 DIFFERENTIAL MODULES AND FILTRATIONS

Let K, A, A_0, K_0 and B are as in Section 2. We assume that $p \nmid e = e_K$, i.e., K/K_0 is tamely totally ramified extension from here. Let k be the constant field of K (cf. [18]), i.e., k is the complete discrete valuation subfield of K with the restriction of the valuation of K , algebraically closed in K , and the

residue field of k is the maximal perfect subfield of F . Then there exists a prime element of K such that π is the element of k . Let $k_0 = K_0 \cap k$. Then π is algebraic over k_0 and we get $\hat{\Omega}_{\mathcal{O}_{k_0}}^1 = 0$, where \mathcal{O}_{k_0} is the ring of integers of k_0 . Thus $\pi^{e-1}d\pi = 0$ in $\hat{\Omega}_A^1$ by taking the differential of the minimal equation of π over k_0 .

By the equation $\pi^{e-1}d\pi = 0$ in $\hat{\Omega}_A^1$, we have

$$\hat{\Omega}_A^q \cong \left(\bigoplus_{i_1 < i_2 < \dots < i_q} A \frac{dT_{i_1}}{T_{i_1}} \wedge \dots \wedge \frac{dT_{i_q}}{T_{i_q}} \right) \oplus \left(\bigoplus_{i_1 < i_2 < \dots < i_{q-1}} A/(\pi^{e-1}) \frac{dT_{i_1}}{T_{i_1}} \wedge \dots \wedge \frac{dT_{i_{q-1}}}{T_{i_{q-1}}} \wedge d\pi \right), \tag{24}$$

where $\{T_i\} = \mathbb{T}$. We introduce a filtration on $\hat{\Omega}_A^q$ as follows. Let

$$\text{fil}^i \hat{\Omega}_A^q = \begin{cases} \hat{\Omega}_A^q & (\text{if } i = 0) \\ \pi^i \hat{\Omega}_A^q + \pi^{i-1} d\pi \wedge \hat{\Omega}_A^{q-1} & (\text{if } i \geq 1). \end{cases}$$

The subquotients are

$$\begin{aligned} \text{gr}^i \hat{\Omega}_A^q &= \text{fil}^i \hat{\Omega}_A^q / \text{fil}^{i+1} \hat{\Omega}_A^q \\ &= \begin{cases} \Omega_F^q & (\text{if } i = 0 \text{ or } i \geq e) \\ \Omega_F^q \oplus \Omega_F^{q-1} & (\text{if } 1 \leq i < e), \end{cases} \end{aligned}$$

where the map is

$$\begin{aligned} \pi^i \hat{\Omega}_A^q \ni \pi^i \omega &\longmapsto \bar{\omega} \in \Omega_F^q \\ \pi^{i-1} d\pi \wedge \hat{\Omega}_A^{q-1} \ni \pi^{i-1} d\pi \wedge \omega &\longmapsto \bar{\omega} \in \Omega_F^{q-1}. \end{aligned}$$

Let $\text{fil}^i(\hat{\Omega}_A^q/pd\hat{\Omega}_A^{q-1})$ be the image of $\text{fil}^i \hat{\Omega}_A^q$ in $\hat{\Omega}_A^q/pd\hat{\Omega}_A^{q-1}$. Then we have the following

PROPOSITION 3.1. For $j \geq 0$,

$$\text{gr}^j \left(\hat{\Omega}_A^q/pd\hat{\Omega}_A^{q-1} \right) = \begin{cases} \Omega_F^q & (j = 0) \\ \Omega_F^q \oplus \Omega_F^{q-1} & (1 \leq j < e) \\ \Omega_F^q/B_l^q & (e \leq j), \end{cases}$$

where l be the maximal integer which satisfies $j - le \geq 0$.

Proof. If $1 \leq j < e$, $\text{gr}^j \hat{\Omega}_A^q = \text{gr}^j(\hat{\Omega}_A^q/pd\hat{\Omega}_A^{q-1})$ because $pd\hat{\Omega}_A^{q-1} \subset \text{fil}^e \hat{\Omega}_A^q$. Assume that $j \geq e$ and let l as above. By (24) and $\pi^e d\pi = 0$, $\hat{\Omega}_A^{q-1}$ is generated by the elements $p\pi^i d\omega$ for $0 \leq i < e$ and $\omega \in \hat{\Omega}_{A_0}^{q-1}$. By [7] (Cor. 2.3.14), $p\pi^i d\omega \in \text{fil}^{e(1+n)+i} \hat{\Omega}_A^q$ if and only if the residue class of $p^{-n}d\omega$ belongs to B_{n+1} . Thus $\text{gr}^j(\hat{\Omega}_A^q/pd\hat{\Omega}_A^{q-1}) \cong \Omega_F^q/B_l^q$. \square

We need the lemma in the following sections.

LEMMA 3.2. (i) For $n \geq 0$, there exist maps

$$f_q^n = \frac{f^n}{p^{nq}} : \hat{\Omega}_{A_0}^q \longrightarrow \mathfrak{Z}_n \hat{\Omega}_{A_0}^q.$$

(ii) For $n \geq 1$,

$$\mathfrak{Z}_n \hat{\Omega}_{A_0}^q = \left(\sum_{l=0}^{n-1} p^l f_q^{n-l} \hat{\Omega}_{A_0}^q \right) + p^n \hat{\Omega}_{A_0}^q + \mathfrak{Z}_\infty \hat{\Omega}_{A_0}^q.$$

(iii) For $n \geq 1$,

$$\bigoplus_{i=0}^{n-1} \frac{d}{p^i} \circ f_{q-1}^i : \left(\hat{\Omega}_{A_0}^{q-1} / \mathfrak{Z}_1 \hat{\Omega}_{A_0}^{q-1} \right)^{\oplus n} \longrightarrow \hat{\Omega}_{A_0}^q / p \cong \Omega_F^q$$

is injective and the image is $B_n \Omega_F^q$.

(iv) For any $n \geq 0$,

$$\hat{\Omega}_{A_0}^q / \mathfrak{Z}_1 \hat{\Omega}_{A_0}^q \xrightarrow{f_q^n} \mathfrak{Z}_n \hat{\Omega}_{A_0}^q / (\mathfrak{Z}_{n+1} \hat{\Omega}_{A_0}^q + \mathfrak{Z}_n \hat{\Omega}_{A_0}^q \cap p \hat{\Omega}_{A_0}^q)$$

is an isomorphism.

(v) For any $n \geq 0$,

$$\left(\hat{\Omega}_{A_0}^q / p \right) \oplus \left(\hat{\Omega}_{A_0}^{q-1} / \mathfrak{Z}_1 \hat{\Omega}_{A_0}^{q-1} \right)^{\oplus n} \xrightarrow{f_q^n \oplus \bigoplus_{i=0}^{n-1} \frac{d}{p^i} \circ f_{q-1}^i} \frac{\mathfrak{Z}_n \hat{\Omega}_{A_0}^q}{\mathfrak{Z}_n \hat{\Omega}_{A_0}^q \cap p \hat{\Omega}_{A_0}^q}$$

is an isomorphism.

Proof. (i) By (12), $f^n(\omega)$ belongs to $p^{nq} \hat{\Omega}_{A_0}^q$. $\hat{\Omega}_{A_0}^q$ is p -torsion free, thus f_q^n is well-defined as the map to $\hat{\Omega}_{A_0}^q$. Furthermore,

$$d(f_q^n(\omega)) = \frac{1}{p^{nq}} f^n(d\omega) = p^n f_{q+1}^n(d\omega),$$

thus $f_q^n(\omega) \in \mathfrak{Z}_n \hat{\Omega}_{A_0}^q$.

(ii) For $0 \leq l \leq n - 1$, the image of the natural injection

$$\begin{aligned} & \frac{\mathfrak{Z}_n \hat{\Omega}_{A_0}^q \cap p^l \hat{\Omega}_{A_0}^q}{(\mathfrak{Z}_n \hat{\Omega}_{A_0}^q \cap p^{l+1} \hat{\Omega}_{A_0}^q) + (\mathfrak{Z}_\infty \hat{\Omega}_{A_0}^q \cap p^l \hat{\Omega}_{A_0}^q)} \\ & \longrightarrow \frac{p^l \hat{\Omega}_{A_0}^q}{p^{l+1} \hat{\Omega}_{A_0}^q + (\mathfrak{Z}_\infty \hat{\Omega}_{A_0}^q \cap p^l \hat{\Omega}_{A_0}^q)} \cong \Omega_F^q / Z_\infty \Omega_F^q \end{aligned}$$

is coincide with $Z_{n-l}\Omega_F^q/Z_\infty\Omega_F^q$ by [7] (Cor. 3.2.14). The image of $p^l f_q^{n-l}\hat{\Omega}_{A_0}^q$ is also $Z_{n-l}\Omega_F^q/Z_\infty\Omega_F^q$ for all l , thus the natural projection

$$\left(\sum_{l=0}^{n-1} p^l f_q^{n-l}\hat{\Omega}_{A_0}^q\right) \rightarrow \frac{\mathfrak{Z}_n\hat{\Omega}_{A_0}^q}{p^n\hat{\Omega}_{A_0}^q + \mathfrak{Z}_\infty\hat{\Omega}_{A_0}^q}$$

is surjective. Hence we have (ii).

(iii) The following diagram commute

$$\begin{array}{ccc} \left(\hat{\Omega}_{A_0}^{q-1}/\mathfrak{Z}_1\hat{\Omega}_{A_0}^{q-1}\right)^{\oplus n} & \xrightarrow{\bigoplus_{i=0}^{n-1} \frac{d}{p^i} \circ f_{q-1}^i} & \hat{\Omega}_{A_0}^q/p \\ \cong \downarrow & & \cong \downarrow \\ \left(\Omega_F^{q-1}/Z_1^{q-1}\right)^{\oplus n} & \xrightarrow{\bigoplus_{i=0}^{n-1} C^{-i} d} & \Omega_F^q. \end{array}$$

The image of the bottom arrow is B_n^q .

(iv) The image of $\mathfrak{Z}_n\hat{\Omega}_{A_0}^q/(\mathfrak{Z}_n\hat{\Omega}_{A_0}^q \cap p\hat{\Omega}_{A_0}^q)$ under the isomorphism $\hat{\Omega}_{A_0}^q/p \rightarrow \Omega_F^q$ is Z_n^q by [7] (Cor. 3.2.14). (iv) follows from the diagram

$$\begin{array}{ccc} \hat{\Omega}_{A_0}^q/\mathfrak{Z}_1\hat{\Omega}_{A_0}^q & \xrightarrow{f_q^n} & \mathfrak{Z}_l\hat{\Omega}_{A_0}^q/(\mathfrak{Z}_{n+1}\hat{\Omega}_{A_0}^q + \mathfrak{Z}_n\hat{\Omega}_{A_0}^q \cap p\hat{\Omega}_{A_0}^q) \\ \cong \downarrow & & \cong \downarrow \\ \Omega_F^q/Z_1^q & \xrightarrow{C^{-n}} & Z_n^q/Z_{n+1}^q. \end{array}$$

(v) The image of

$$\left(\hat{\Omega}_{A_0}^{q-1}/\mathfrak{Z}_1\hat{\Omega}_{A_0}^{q-1}\right)^{\oplus n} \xrightarrow{\bigoplus_{i=0}^{n-1} \frac{d}{p^i} \circ f_{q-1}^i} \hat{\Omega}_{A_0}^q/p \cong \Omega_F^q$$

is B_n^q by (iii), and the image of the composite

$$\hat{\Omega}_{A_0}^q/p \xrightarrow{f_q^n} \hat{\Omega}_{A_0}^q/p \cong \Omega_F^q \rightarrow \Omega_F^q/B_n^q$$

is Z_n^q/B_n^q . Hence we get (v). □

4 THE IMAGE OF $H^1(\mathbb{S}_q)$

We assume $p \nmid e$. We further assume that there exists the prime element π of K such that $\pi^e = p$. If there does not exist such π , we replace K by $K(p^{\frac{1}{e}})$. Note that the extension $K(p^{\frac{1}{e}})/K$ is unramified of degree prime to p . In this section, we calculate $\psi(H^1(\mathbb{S}_q))$ explicitly. We need some preparations.

Let N_0^q be the subset of $\hat{\Omega}_{A_0}^q$ such that the canonical map $N_0^q \rightarrow \Omega_F^q \setminus Z_1^q$ is an injection, the image generates Ω_F^q/Z_1^q and have the property

$$\text{If } \bar{\omega} + C^{-1}\bar{\omega} = 0, \text{ then } d\omega = 0. \tag{25}$$

We can take such N_0^q because of the following

LEMMA 4.1. *Take $x \in \hat{\Omega}_F^q$. If $x + C^{-1}x = 0$ then there exists $\omega \in \hat{\Omega}_{A_0}^q$ such that $\bar{\omega} = x$ and $d\omega = 0$.*

Proof. x can be written as

$$x = \sum_{\tau} x_{\tau} \tau,$$

where τ runs through the canonical generators (cf. in the proof of (2.7)) and $x_{\tau} \in F$. The assumption $x + C^{-1}x = 0$ means that $x_{\tau} + x_{\tau}^p = 0$ for all τ , thus $x_{\tau} \in E$ for all τ , where E is the maximal perfect subfield of F . The canonical generators have the fixed lifts denoted by $\tilde{\tau}$, and we can take lifts of x_{τ} , denoted by \tilde{x}_{τ} , in the ring of Witt vectors with coefficients in E , denotes $W(E)$. Fix an inclusion $W(E) \rightarrow A_0$. Let

$$\omega = \sum_{\tau} \tilde{x}_{\tau} \tilde{\tau}.$$

Then $d\omega = 0$ in $\hat{\Omega}_{A_0}^q$ because $d\tilde{x}_{\tau} = 0$ in $\hat{\Omega}_{A_0}^q$ and $\bar{\omega} = x$. This ω is the desired one. \square

For any $q, l \geq 0$, let $N_l^q = f_l^q(N_0^q)$ as a subset of $\hat{\Omega}_{A_0}^q$ and let

$$\begin{aligned} N_{\infty}^q &= \mathfrak{Z}_{\infty} \hat{\Omega}_{A_0}^q \setminus (\mathfrak{Z}_{\infty} \hat{\Omega}_{A_0}^q \cap p \hat{\Omega}_{A_0}^q), \\ N_f^q &= \bigcup_{l \geq 0} N_l^q, \quad N^q = N_f^q \cup N_{\infty}^q. \end{aligned}$$

Then, by (3.2,iv), N^q generates $\hat{\Omega}_{A_0}^q/p$ and $\omega \neq 0$ in $\hat{\Omega}_{A_0}^q/p$ for all $\omega \in N^q$. Furthermore, by using (3.2,v) and the isomorphism

$$\frac{\mathfrak{Z}_{n-1} \hat{\Omega}_{A_0}^q}{\mathfrak{Z}_{n-1} \hat{\Omega}_{A_0}^q \cap p \hat{\Omega}_{A_0}^q} \xrightarrow{p} \frac{\mathfrak{Z}_n \hat{\Omega}_{A_0}^q \cap p \hat{\Omega}_{A_0}^q}{\mathfrak{Z}_n \hat{\Omega}_{A_0}^q \cap p^2 \hat{\Omega}_{A_0}^q},$$

we have

$$\begin{aligned} \left\langle f_q^n N^q \cup \bigcup_{m=0}^{n-1} \frac{d}{p^m} f_{q-1}^m N_0^{q-1} \right\rangle &= \frac{\mathfrak{Z}_n \hat{\Omega}_{A_0}^q}{\mathfrak{Z}_n \hat{\Omega}_{A_0}^q \cap p \hat{\Omega}_{A_0}^q}, \\ \left\langle p f_q^{n-1} N^q \cup \bigcup_{m=0}^{n-2} p \frac{d}{p^m} f_{q-1}^m N_0^{q-1} \right\rangle &= \frac{\mathfrak{Z}_n \hat{\Omega}_{A_0}^q \cap p \hat{\Omega}_{A_0}^q}{\mathfrak{Z}_n \hat{\Omega}_{A_0}^q \cap p^2 \hat{\Omega}_{A_0}^q}. \end{aligned} \tag{26}$$

Thus the union of the sets of the left hand side of (26) generates $\mathfrak{Z}_n \hat{\Omega}_{A_0}^q / (\mathfrak{Z}_n \hat{\Omega}_{A_0}^q \cap p^2 \hat{\Omega}_{A_0}^q)$. If $q < 0$ then let $N_l^q = \emptyset$.

Let $S_{i,1}^0, S_{i,1}^1, S_{i,2}^0$ and $S_{i,2}^1$ be the subsets of $D \otimes \hat{\Omega}_B^{q-2}$ defined as follows.

$$\begin{aligned}
 S_{i,1}^0 &= \begin{cases} \emptyset & (i = 0, e \text{ or } i \geq 2e) \\ X^i N^{q-2} & (\text{if } e < i < 2e) \\ \emptyset & (\text{if } 1 \leq i < e, \eta_i - v_p(i) \geq 1) \\ X^i \left(f_{q-2}^{\eta_i} N^{q-2} \cup \bigcup_{m=0}^{\eta_i-1} \frac{d}{p^m} f_{q-3}^m N_0^{q-3} \right) & (\text{if } 1 \leq i < e, \eta_i - v_p(i) \leq 0), \end{cases} \\
 S_{i,1}^1 &= \begin{cases} \emptyset & (i = 0 \text{ or } i \geq e) \\ \emptyset & (1 \leq i < e, \eta_i - v_p(i) \geq 2) \\ X^i \left(p f_{q-2}^{\eta_i-1} N^{q-2} \cup \bigcup_{m=0}^{\eta_i-2} p \frac{d}{p^m} f_{q-3}^m N_0^{q-3} \right) & (1 \leq i < e, \eta_i - v_p(i) \leq 1), \end{cases} \\
 S_{i,2}^0 &= \begin{cases} \emptyset & (i = 0 \text{ or } i > 2e) \\ X^{i-1} dX \wedge N^{q-3} & (e < i \leq 2e) \\ X^{e-1} dX \wedge \left(f_{q-3}^1 N^{q-3} \cup dN_0^{q-4} \right) & (i = e) \\ X^{i-1} dX \wedge \left(f_{q-3}^{\eta_i} N^{q-3} \cup \bigcup_{m=0}^{\eta_i-1} \frac{d}{p^m} f_{q-4}^m N_0^{q-4} \right) & (1 \leq i < e), \end{cases} \\
 S_{i,2}^1 &= \begin{cases} \emptyset & (i = 0 \text{ or } i > e) \\ X^{e-1} dX \wedge pN^q & (\text{if } i = e) \\ X^{i-1} dX \wedge \left(p f_{q-3}^{\eta_i-1} N^{q-3} \cup \bigcup_{m=0}^{\eta_i-2} p \frac{d}{p^m} f_{q-4}^m N_0^{q-4} \right) & (\text{if } 1 \leq i < e). \end{cases}
 \end{aligned}$$

Let $S_{i,1} = S_{i,1}^0 \cup S_{i,1}^1, S_{i,2} = S_{i,2}^0 \cup S_{i,2}^1, S_i = S_{i,1} \cup S_{i,2}$ and S the union of all S_i . By the above definitions, S_i generates $\text{gr}^i H^1(\mathbb{S}_q)$, hence S generates $H^1(\mathbb{S}_q)$.

The following lemma is useful to calculate ψ .

LEMMA 4.2. *If $1 \leq i < e$ then the minimal value of $v_K(\pi^{ip^n}/p^{n+1}) = ip^n - e(n+1)$ is*

$$\begin{cases} ip^{\eta_i-1} - e\eta_i & (\text{when } n = \eta_i - 1; \text{ if } e' < ip^{\eta_i} < ep) \\ ip^{\eta_i} - e(\eta_i + 1) & (\text{when } n = \eta_i; \text{ if } e < ip^{\eta_i} < e') \\ ip^{\eta_i-1} - e\eta_i & (\text{when } n = \eta_i - 1, \eta_i; \text{ if } < ip^{\eta_i} = e') \end{cases}$$

and if $e < i$ then the minimal value of $v_K(\pi^{ip^n}/p^{n+1})$ is $i - e$.

Proof. Lemma follows from the definition of η_i . □

Remark 4.3. Method of calculation of ψ . In (2.6) and in the definition of S , we use elements of $D \otimes \hat{\Omega}_B^{q-2}$, which is the degree zero part of the complex $\sigma_{>q-3} \mathbb{D}[q-2]$, to represent elements of $H^1(\mathbb{S}_q)$. Chasing the complex (6) and the map (8), ψ is the composite of

$$\begin{aligned}
 D \otimes \hat{\Omega}_B^{q-2} &\xrightarrow{d} D \otimes \hat{\Omega}_B^{q-1} \xrightarrow{\sum_{n \geq 0} f_q^n} I \otimes \hat{\Omega}_B^{q-1} \xrightarrow{I \rightarrow pA} pA \otimes \hat{\Omega}_B^{q-1} \\
 &\xrightarrow{p^{-1}} A \otimes \hat{\Omega}_B^{q-1} \xrightarrow{dX=d\pi} \hat{\Omega}_A^{q-1} / pd\hat{\Omega}_A^{q-2}.
 \end{aligned}$$

Thus, for $\omega \in \hat{\Omega}_{A_0}^{q-2}$ (resp. $\omega \in \hat{\Omega}_{A_0}^{q-3}$) and $i \geq 1$,

$$\begin{aligned} \psi(X^i \omega) &= \sum_{n \geq 0} \left(\frac{i}{p^{n+1}} \pi^{ip^n} \frac{d\pi}{\pi} \wedge f_{q-2}^n(\omega) + \frac{1}{p^{n+1}} \pi^{ip^n} f_{q-1}^n(d\omega) \right) \\ &\left(\text{resp. } \psi \left(X^i \frac{dX}{X} \wedge \omega \right) = \sum_{n \geq 0} \frac{1}{p^{n+1}} \pi^{ip^n} \frac{d\pi}{\pi} \wedge f_{q-2}^n(d\omega) \right). \end{aligned} \tag{27}$$

Here, to avoid the complication of notations, we use

$$X^i \frac{dX}{X} \quad \left(\text{resp. } \pi^i \frac{d\pi}{\pi} \right)$$

which only denotes the meaning of $X^{i-1}dX$ (resp. $\pi^{i-1}d\pi$) when $i \geq 1$. By using (4.2), $n = \eta_i - 1$ or $n = \eta_i$ is the number at which the value v_K of the coefficients of $d\pi$ in (27) is the minimal. If $X^i \omega \in S$ (resp. $X^{i-1}dX \wedge \omega \in S$) for $\omega \in \hat{\Omega}_{A_0}^{q-2}$ (resp. $\omega \in \hat{\Omega}_{A_0}^{q-3}$), then ω has the property (22) (resp. (23)). Under this condition, the right hand side of (27) belongs to $\hat{\Omega}_A^{q-1}$. Furthermore, by $\pi^{e-1}\pi = 0$, if $\eta_i \geq 1$ then

$$\begin{aligned} \psi(X^i \omega) &= \frac{i}{p^{\eta_i}} \pi^{ip^{\eta_i-1}} \frac{d\pi}{\pi} \wedge f_{q-2}^{\eta_i-1}(\omega) + \frac{i}{p^{\eta_i+1}} \pi^{ip^{\eta_i}} \frac{d\pi}{\pi} \wedge f_{q-2}^{\eta_i}(\omega) \\ &+ \sum_{n \geq 0} \left(\frac{1}{p^{n+1}} \pi^{ip^n} f_{q-1}^n(d\omega) \right), \\ \psi(X^i \frac{dX}{X} \wedge \omega) &= \frac{1}{p^{\eta_i}} \pi^{ip^{\eta_i-1}} \frac{d\pi}{\pi} \wedge f_{q-2}^{\eta_i-1}(d\omega) + \frac{1}{p^{\eta_i+1}} \pi^{ip^{\eta_i}} \frac{d\pi}{\pi} \wedge f_{q-2}^{\eta_i}(d\omega), \end{aligned}$$

and if $\eta_i = 0$ then

$$\begin{aligned} \psi(X^i \omega) &= \frac{i}{p} \pi^i \frac{d\pi}{\pi} \wedge \omega + \sum_{n \geq 0} \left(\frac{1}{p^{n+1}} \pi^{ip^n} f_{q-1}^n(d\omega) \right), \\ \psi(X^i \frac{dX}{X} \wedge \omega) &= \frac{1}{p} \pi^i \frac{d\pi}{\pi} \wedge d\omega. \end{aligned}$$

Note that if $\eta_i \geq 1$,

$$v_K \left(\frac{1}{p^{\eta_i}} \pi^{ip^{\eta_i-1}} \right) - v_K \left(\frac{1}{p^{\eta_i+1}} \pi^{ip^{\eta_i}} \right) \begin{cases} < 0 & (\text{if } e' < ip^{\eta_i} < ep) \\ > 0 & (\text{if } e < ip^{\eta_i} < e') \\ = 0 & (\text{if } ip^{\eta_i} = e'). \end{cases} \tag{28}$$

By the definition, S generates $H^1(\mathbb{S}_q)$. But $\psi: H^1(\mathbb{S}_q) \rightarrow \hat{\Omega}_A^{q-1}/pd\hat{\Omega}_A^{q-2}$ has the kernel in general. The following lemma compute some subset of this kernel.

LEMMA 4.4. (i) $S_{2e}, S_e \subset \text{Ker } \psi$.

(ii) If $e < i < 2e$ then $\psi(S_{i,2}^0 \setminus (X^{i-1}dX \wedge N_0^{q-3})) = 0$. If $1 \leq i < e$ then $\psi(S_{i,2}^0 \setminus (X^{i-1}dX \wedge f_{q-3}^{\eta_i} N_0^{q-3})) = 0$ and $\psi(S_{i,2}^1 \setminus (X^{i-1}dX \wedge p f_{q-3}^{\eta_i-1} N_0^{q-3})) = 0$.

(iii) If $e < i < 2e$ and $p \nmid i$, then $\psi(S_{i,2}) \subset \langle \psi(S_{i,1}) \rangle$.

(iv) If $e' < i < 2e$ and $p \mid i$, then

$$\psi(S_{i,2}) \subset \left\langle \psi \left(\bigcup_{1 \leq j < e} S_{j,1}^1 \right) \right\rangle.$$

(v) Let $1 \leq i < e$, $s = \eta_i + v_p(i)$ and $i_0 = i/p^{v_p(i)}$. If $e' < ip^{\eta_i} < ep$ and $s \geq 2$, then

$$\psi(S_{i,2}) \subset \left\langle \left(\bigcup_{1 \leq j < e} S_{j,1} \right) \cup S_{ip^{\eta_i-e},1} \right\rangle.$$

Furthermore, let

$$j = \begin{cases} i_0 p^{\frac{s}{2}} & (\text{if } s \text{ is even}), \\ i_0 p^{\frac{s-1}{2}} & (\text{if } s \text{ is odd}). \end{cases}$$

Then

$$\begin{aligned} \psi(S_{i,2}^0) &\subset \langle \psi(S_{j,1}) \rangle && \text{if } 3\eta_i \geq v_p(i), \\ \psi(S_{i,2}^1) &\subset \langle \psi(S_{j,1}) \rangle && \text{if } 3\eta_i \geq v_p(i) + 2. \end{aligned}$$

Proof. (i) Take $X^{2e-1}dX \wedge \omega \in S_{2e,2}$. Then

$$\psi \left(X^{2e} \frac{dX}{X} \wedge \omega \right) = \frac{1}{p} \pi^{2e} \frac{d\pi}{\pi} \wedge d\omega = 0$$

by (4.3). Next, take $X^{e-1}dX \wedge \omega \in S_{e,2}$. By the definition of $S_{e,2}$, such an ω can be divided by p . Thus, by using (4.3), we get

$$\psi \left(X^e \frac{dX}{X} \wedge \omega \right) = \frac{1}{p} \pi^e \frac{d\pi}{\pi} \wedge p \frac{d\omega}{p} = 0.$$

(ii) At first, let $e < i < 2e$. When we take $X^{i-1}dX \wedge \omega$ from $S_{i,2}^0 \setminus (X^{i-1}dX \wedge N_0^{q-3})$, then ω has the property $v_p(d\omega) \geq 1$. Thus by using (4.3),

$$\psi \left(X^i \frac{dX}{X} \wedge \omega \right) = \frac{1}{p} \pi^i \frac{d\pi}{\pi} \wedge p \frac{d\omega}{p} = 0.$$

Next let $1 \leq i < e$. When we take $X^{i-1}dX \wedge \omega$ from

$$\left(S_{i,2}^0 \setminus \left(X^i \frac{dX}{X} \wedge f_{q-3}^{\eta_i} N_0^{q-3} \right) \right) \cup \left(S_{i,2}^1 \setminus \left(X^i \frac{dX}{X} \wedge p f_{q-3}^{\eta_i-1} N_0^{q-3} \right) \right),$$

ω has the property $v_p(d\omega) \geq \eta_i + 1$. Thus $\psi(X^{i-1}dX \wedge \omega) = 0$ by using (4.3).

(iii) In this case, $S_{i,2} = X^{i-1}dX \wedge N^{q-3}$ and $S_{i,1} = X^i N^{q-2}$. For an element $X^{i-1}dX \wedge \omega \in S_{i,2}$ with $\omega \in N^{q-3}$, there exists $X^i d\omega \in S_{i,1}$ because $d\omega \in N_\infty^{q-2}$, and

$$d \left(X^i \frac{dX}{X} \wedge \omega \right) = d \left(\frac{X^i d\omega}{i} \right).$$

This means $\psi(X^{i-1}dX \wedge \omega) = \psi(X^i d\omega)/i$. Thus $\psi(S_{i,2}) \subset \langle \psi(S_{i,1}) \rangle$.

(iv) Take an element $X^{i-1}dX \wedge \omega \in S_{i,2}$ with $\omega \in N^{q-3}$. Let $j = j_0 = i - e$ and $j_l = j_{l-1}p - e$ for $j \geq 1$. Then, $\{j_l\}_l$ have the property

$$p \nmid j_l, \\ \frac{e}{p-1} < j_0 < j_1 < j_2 < \dots$$

by $p \mid i$ and $i > e'$. Let L be the minimal integer such that $j_L \geq 2e/p$. Then $\eta_{j_l} = 1$ for all $0 \leq l \leq L$. There exist the elements $X^{j_l} p f_{q-2}^l(d\omega) \in S_{j_l,1}^1$ because $S_{j_l,1}^1 = X^{j_l} N^{q-2}$ and $p f_{q-2}^l(d\omega) \in N_\infty^{q-2}$. Thus the element, denoted by Y ,

$$Y = \sum_{l=0}^L \frac{(-1)^l}{j_l} X^{j_l} p f_{q-2}^l(d\omega)$$

exists in $\langle \bigcup_{k=1}^{e-1} S_{k,1}^1 \rangle$. By (4.3), $\psi(X^{i-1}dX \wedge \omega) = \pi^{i-e-1} d\pi \wedge d\omega$. On the other hand,

$$\begin{aligned} \psi(Y) &= \sum_{l=0}^L \left((-1)^l \pi^{j_l} \frac{d\pi}{\pi} \wedge f_{q-2}^l(d\omega) + (-1)^l \frac{1}{p} \pi^{j_l p} \frac{d\pi}{\pi} \wedge f_{q-2}^{l+1}(d\omega) \right) \\ &= \sum_{l=0}^L \left((-1)^l \pi^{j_l} \frac{d\pi}{\pi} \wedge f_{q-2}^l(d\omega) + (-1)^l \pi^{j_{l+1}} \frac{d\pi}{\pi} \wedge f_{q-2}^{l+1}(d\omega) \right) \\ &= \pi^{j_0} \frac{d\pi}{\pi} \wedge d\omega. \end{aligned}$$

The third equation follows from $j_{L+1} - 1 \geq e - 1$. Hence $\psi(X^{i-1}dX \wedge \omega) = \psi(Y)$ because $j_0 = i - e$, and we get (iv).

(v) Now $S_{i,2}^0$ and $S_{i,2}^1$ are

$$\begin{aligned} S_{i,2}^0 &= X^i \frac{dX}{X} \wedge \left(f_{q-3}^{\eta_i} N^{q-3} \cup \bigcup_{m=0}^{\eta_i-1} \frac{d}{p^m} f_{q-4}^m N_0^{q-4} \right), \\ S_{i,2}^1 &= X^i \frac{dX}{X} \wedge \left(p f_{q-3}^{\eta_i-1} N^{q-3} \cup \bigcup_{m=0}^{\eta_i-2} p \frac{d}{p^m} f_{q-4}^m N_0^{q-4} \right). \end{aligned}$$

By (ii), we only have to calculate the element of

$$X^i \frac{dX}{X} \wedge f_{q-3}^{\eta_i} N_0^{q-3}, \quad X^i \frac{dX}{X} \wedge p f_{q-3}^{\eta_i-1} N_0^{q-3}$$

to show (v). If $e' < ip^{\eta_i} < ep$ and $s \geq 2$, then

$$\begin{aligned} X^i \frac{dX}{X} \wedge f_{q-3}^{\eta_i} \omega &= \pi^{ip^{\eta_i-1}} \frac{d\pi}{\pi} \wedge f_{q-2}^{2\eta_i-1}(d\omega) \\ &\quad + \pi^{ip^{\eta_i}-e} \frac{d\pi}{\pi} \wedge f_{q-2}^{2\eta_i}(d\omega), \\ X^i \frac{dX}{X} \wedge p f_{q-3}^{\eta_i-1} \omega &= \pi^{ip^{\eta_i-1}} \frac{d\pi}{\pi} \wedge f_{q-2}^{2\eta_i-2}(d\omega) \\ &\quad + \pi^{ip^{\eta_i}-e} \frac{d\pi}{\pi} \wedge f_{q-2}^{2\eta_i-1}(d\omega). \end{aligned}$$

The first terms of the right hand side come from

$$\begin{aligned} S_{ip^{\eta_i-1}+e,1} &\supset X^{ip^{\eta_i-1}+e} N_{\infty}^{q-2} \\ &\ni X^{ip^{\eta_i-1}+e} f_{q-2}^{2\eta_i-1}(d\omega) \xrightarrow{\psi} e\pi^{ip^{\eta_i-1}} \frac{d\pi}{\pi} \wedge f_{q-2}^{2\eta_i-1}(d\omega), \\ S_{ip^{\eta_i-1}+e,1} &\supset X^{ip^{\eta_i-1}+e} N_{\infty}^{q-2} \\ &\ni X^{ip^{\eta_i-1}+e} f_{q-2}^{2\eta_i-2}(d\omega) \xrightarrow{\psi} e\pi^{ip^{\eta_i-1}} \frac{d\pi}{\pi} \wedge f_{q-2}^{2\eta_i-2}(d\omega). \end{aligned}$$

On the other hand, the second terms of the right hand side are, if $ip^{\eta_i} \geq 2e$ then vanished. If $ip^{\eta_i} < 2e$, then by using the same argument of (iv) with $j_0 = ip^{\eta_i} - e$ and

$$Y = \begin{cases} \sum_{l=0}^L \frac{(-1)^l}{j_l} X^{j_l} p f_{q-2}^l (f_{q-2}^{2\eta_i}(d\omega)) & \text{(the first case)} \\ \sum_{l=0}^L \frac{(-1)^l}{j_l} X^{j_l} p f_{q-2}^l (f_{q-2}^{2\eta_i-1}(d\omega)) & \text{(the second case),} \end{cases}$$

we get

$$\psi(S_{i,2}) \subset \left\langle \left(\bigcup_{1 \leq j < e} S_{j,1} \right) \cup S_{ip^{\eta_i}-e,1} \right\rangle.$$

Next, we do not assume $e < ip^{\eta_i} < e'$ and $s \geq 2$. In this case, we have to show

$$\begin{aligned} \psi \left(X^i \frac{dX}{X} \wedge f_{q-3}^{\eta_i} N_0^{q-3} \right) &\subset \psi(S_{j,1}) \quad \text{if } 3\eta_i \geq v_p(i), \\ \psi \left(X^i \frac{dX}{X} \wedge p f_{q-3}^{\eta_i-1} N_0^{q-3} \right) &\subset \psi(S_{j,1}) \quad \text{if } 3\eta_i \geq v_p(i) + 2. \end{aligned}$$

Take $\omega \in N_0^{q-3}$. Then, by (4.3),

$$\begin{aligned} & \psi \left(X^i \frac{dX}{X} \wedge f_{q-3}^{\eta_i}(\omega) \right) \\ &= \pi^{ip^{\eta_i-1}} \frac{d\pi}{\pi} \wedge f_{q-2}^{2\eta_i-1}(d\omega) + \pi^{ip^{\eta_i-e}} \frac{d\pi}{\pi} \wedge f_{q-2}^{2\eta_i}(d\omega), \\ & \psi \left(X^i \frac{dX}{X} \wedge pf_{q-3}^{\eta_i-1}(\omega) \right) \\ &= \pi^{ip^{\eta_i-1}} \frac{d\pi}{\pi} \wedge f_{q-2}^{2\eta_i-2}(d\omega) + \pi^{ip^{\eta_i-e}} \frac{d\pi}{\pi} \wedge f_{q-2}^{2\eta_i-1}(d\omega). \end{aligned}$$

On the other hand, there exist elements

$$\begin{aligned} \omega'_1 &= f_{q-2}^{2\eta_i-\frac{s}{2}}(d\omega) && (\text{if } s \text{ is even and } 3\eta_i \geq v_p(i)), \\ \omega'_2 &= pf_{q-2}^{2\eta_i-\frac{s+1}{2}}(d\omega) && (\text{if } s \text{ is odd and } 3\eta_i \geq v_p(i)), \\ \omega'_3 &= f_{q-2}^{2\eta_i-\frac{s}{2}-1}(d\omega) && (\text{if } s \text{ is even and } 3\eta_i \geq v_p(i) + 2), \\ \omega'_4 &= pf_{q-2}^{2\eta_i-\frac{s+1}{2}-1}(d\omega) && (\text{if } s \text{ is odd and } 3\eta_i \geq v_p(i) + 2) \end{aligned}$$

in $\hat{\Omega}_{A_0}^{q-2}$ because the conditions are, $2\eta_i \geq s/2$ if and only if $3\eta_i \geq v_p(i)$ when s is even, $2\eta_i \geq (s+1)/2$ if and only if $3\eta_i \geq v_p(i)$ when s is odd, $2\eta_i \geq (s/2)+1$ if and only if $3\eta_i \geq v_p(i) + 2$ when s is even, and $2\eta_i \geq ((s+1)/2) + 1$ if and only if $3\eta_i \geq v_p(i) + 2$ when s is odd. The image of ψ of an each element is

$$\begin{aligned} \psi(X^j \omega'_1) &= i_0 \pi^{i_0 p^{s-1}} \frac{d\pi}{\pi} \wedge f_{q-2}^{\frac{s}{2}-1}(\omega'_1) + \frac{i_0}{p} \pi^{i_0 p^s} \frac{d\pi}{\pi} \wedge f_{q-2}^{\frac{s}{2}}(\omega'_1) \\ &= i_0 \pi^{ip^{\eta_i-1}} \frac{d\pi}{\pi} \wedge f_{q-2}^{2\eta_i-1}(d\omega) + i_0 \pi^{ip^{\eta_i-e}} \frac{d\pi}{\pi} \wedge f_{q-2}^{2\eta_i}(d\omega) \\ &= i_0 \psi \left(X^i \frac{dX}{X} \wedge f_{q-3}^{\eta_i}(\omega) \right), \end{aligned}$$

$$\begin{aligned} \psi(X^j \omega'_2) &= \frac{i_0}{p} \pi^{i_0 p^{s-1}} \frac{d\pi}{\pi} \wedge f_{q-2}^{\frac{s-1}{2}}(\omega'_2) + \frac{i_0}{p^2} \pi^{i_0 p^s} \frac{d\pi}{\pi} \wedge f_{q-2}^{\frac{s+1}{2}}(\omega'_2) \\ &= i_0 \pi^{ip^{\eta_i-1}} \frac{d\pi}{\pi} \wedge f_{q-2}^{2\eta_i-1}(d\omega) + i_0 \pi^{ip^{\eta_i-e}} \frac{d\pi}{\pi} \wedge f_{q-2}^{2\eta_i}(d\omega) \\ &= i_0 \psi \left(X^i \frac{dX}{X} \wedge f_{q-3}^{\eta_i}(\omega) \right), \end{aligned}$$

$$\begin{aligned} \psi(X^j \omega'_3) &= i_0 \pi^{i_0 p^{s-1}} \frac{d\pi}{\pi} \wedge f_{q-2}^{\frac{s}{2}-1}(\omega'_3) + \frac{i_0}{p} \pi^{i_0 p^s} \frac{d\pi}{\pi} \wedge f_{q-2}^{\frac{s}{2}}(\omega'_3) \\ &= i_0 \pi^{ip^{\eta_i-1}} \frac{d\pi}{\pi} \wedge f_{q-2}^{2\eta_i-2}(d\omega) + i_0 \pi^{ip^{\eta_i-e}} \frac{d\pi}{\pi} \wedge f_{q-2}^{2\eta_i-1}(d\omega) \\ &= i_0 \psi \left(X^i \frac{dX}{X} \wedge pf_{q-3}^{\eta_i-1}(\omega) \right), \end{aligned}$$

$$\begin{aligned} \psi(X^j \omega'_4) &= \frac{i_0}{p} \pi^{i_0 p^{s-1}} \frac{d\pi}{\pi} \wedge f_{q-2}^{\frac{s-1}{2}}(\omega'_4) + \frac{i_0}{p^2} \pi^{i_0 p^s} \frac{d\pi}{\pi} \wedge f_{q-2}^{\frac{s+1}{2}}(\omega'_4) \\ &= i_0 \pi^{i p^{\eta_i-1}} \frac{d\pi}{\pi} \wedge f_{q-2}^{2\eta_i-2}(d\omega) + i_0 \pi^{i p^{\eta_i-e}} \frac{d\pi}{\pi} \wedge f_{q-2}^{2\eta_i-1}(d\omega) \\ &= i_0 \psi \left(X^i \frac{dX}{X} \wedge p f_{q-3}^{\eta_i-1}(\omega) \right). \end{aligned}$$

Compare the definition of $S_{j,1}$ with the condition of $\omega'_1, \dots, \omega'_4$. If s is even and $3\eta_i \geq v_p(i)$ then

$$X^j \omega'_1 = \begin{cases} X^j \frac{d}{p^{2\eta_i-\frac{s}{2}}} f_{q-2}^{2\eta_i-\frac{s}{2}}(d\omega) \in X^j \frac{d}{p^{2\eta_i-\frac{s}{2}}} f_{q-2}^{2\eta_i-\frac{s}{2}} N_0^{q-3} & (\text{if } \eta_i - \frac{s}{2} \leq \eta_j - 1), \\ X^j f_{q-2}^{\eta_j} f_{q-2}^{2\eta_i-\frac{s}{2}-\eta_j}(d\omega) \in X^j f_{q-2}^{\eta_j} N_\infty^{q-2} & (\text{if } \eta_i - \frac{s}{2} \geq \eta_j). \end{cases}$$

Thus $X^j \omega'_1 \in S_{i,1}^0$. By the similar way, we have

$$\begin{aligned} X^j \omega'_2 &\in S_{j,1}^1 && (\text{if } s \text{ is odd and } 3\eta_i \geq v_p(i)), \\ X^j \omega'_3 &\in S_{j,1}^0 && (\text{if } s \text{ is even and } 3\eta_i \geq v_p(i) + 2), \\ X^j \omega'_4 &\in S_{j,1}^1 && (\text{if } s \text{ is odd and } 3\eta_i \geq v_p(i) + 2). \end{aligned}$$

The claim (v) was proved. □

Remark 4.5. Let $S'_{i,2}{}^0$ (resp. $S'_{i,2}{}^1$) be the subset of $S_{i,2}^0$ (resp. $S_{i,2}^1$) defined as follows.

$$S'_{i,2}{}^0 = \begin{cases} X^i \frac{dX}{X} \wedge N_0^{q-3} & (e < i \leq e', p \mid i) \\ X^i \frac{dX}{X} \wedge f_{q-3}^{\eta_i} N_0^{q-3} & 1 \leq i < e, e < i p^{\eta_i} \leq e', 3\eta_i < v_p(i) \\ \emptyset & (\text{otherwise}), \end{cases}$$

$$S'_{i,2}{}^1 = \begin{cases} X^i \frac{dX}{X} \wedge p f_{q-3}^{\eta_i-1} N_0^{q-3} & (1 \leq i < e, e < i p^{\eta_i} \leq e', 3\eta_i < v_p(i) + 2) \\ \emptyset & (\text{otherwise}). \end{cases}$$

Remark that if $1 \leq i < e$ satisfies $v_p(i) + \eta_i = 1$ and $e' < i p^{\eta_i} < e p$, then $v_p(i) = 0$, $e/(p-1) < i < e$ and $\eta_i = 1$. Thus this i satisfies neither $3\eta_i < v_p(i) + 2$ nor $3\eta_i < v_p(i)$. Let $S'_{i,2} = S'_{i,2}{}^0 \cup S'_{i,2}{}^1$. Then by (4.4), $\psi(H^1(\mathbb{S}_q))$ is generated by

$$\left(\bigcup_{1 \leq i < 2e} S_{i,1} \right) \cup \left(\bigcup_{1 \leq i < 2e} S'_{i,2} \right).$$

We need some modification of generators of $\psi(H^1(\mathbb{S}_q))$ as follows.

Let the index sets Λ_0 and Λ_1 be

$$\Lambda_0 = \{i ; 1 \leq i < e, e' < i p^{\eta_i} < 2e, \eta_i = v_p(i)\}, \tag{29}$$

$$\Lambda_1 = \{i ; 1 \leq i < e, e' < ip^{\eta_i} < 2e, \eta_i = v_p(i) + 1, p \nmid (i + e)\}. \tag{30}$$

Let $\Lambda = \Lambda_0 \cup \Lambda_1$. For $i \in \Lambda$, let

$$\begin{aligned} s &= \eta_i + v_p(i), \\ i' &= i/p^{v_p(i)}, \\ i_0 &= i'p^{s-1}, \\ i_l &= i_{l-1}p - e \text{ for } l \geq 1, \\ L &= \text{Min}\{l ; i_l \geq 2e/p\}. \end{aligned} \tag{31}$$

$\{i_l\}_l$ are monotonely increasing, thus we can take such L . Note that $p \nmid i'$, $\eta_{i_l} = 1$ for $0 \leq l \leq L$ and $p \nmid i_l$ for $l \geq 1$. If $i \in \Lambda_0$ then let $g_{i,0}$ be

$$g_{i,0}(X^i\omega) = \frac{1}{i'}X^i\omega - \frac{1}{i_0 + e}X^{i_0+e}f_{q-2}^{\eta_i-1}(\omega) + \sum_{l=1}^{L-1} \frac{(-1)^l}{i_l}pX^{i_l}f_{q-2}^{\eta_i+l-1}(\omega)$$

for $\omega \in \mathfrak{Z}_{\eta_i}\hat{\Omega}_{A_0}^{q-2}$. This function satisfies $g_{i,0}(\omega) \equiv (1/i')X^i\omega$ modulo $\text{fil}^{i+1}H^1(\mathbb{S}_q)$, thus we can replace $S_{i,1}^0$ by $g_{i,0}(S_{i,1}^0)$ to generate $\psi(H^1(\mathbb{S}_q))$. When $i \in \Lambda_1$, then let $g_{i,1}$ be

$$g_{i,1}(X^i p\omega) = \frac{1}{i'}X^i p\omega - \frac{1}{i_0 + e}X^{i_0+e}f_{q-2}^{\eta_i-1}(\omega) + \sum_{l=1}^{L-1} \frac{(-1)^l}{i_l}pX^{i_l}f_{q-2}^{\eta_i+l-1}(\omega)$$

for $p\omega \in p\hat{\Omega}_{A_0}^{q-2} \cap \mathfrak{Z}_{\eta_i}\hat{\Omega}_{A_0}^{q-2}$. This function satisfies $g_{i,1}(p\omega) \equiv (1/i')X^i p\omega$ modulo $\text{fil}^{i+1}H^1(\mathbb{S}_q)$, thus we can replace $S_{i,1}^1$ by $g_{i,1}(S_{i,1}^1)$ to generate $\psi(H^1(\mathbb{S}_q))$.

5 EXPLICIT CALCULATION, CASE (a)

We compute $\psi(S_{i,1})$, $\psi(S'_{i,2})$, $\psi(g_{i,0}S_{i,1}^0)$ and $\psi(g_{i,1}S_{i,1}^1)$ explicitly in Section 5, 6 and 7.

Define the index sets as

$$\begin{aligned} \Gamma_a &= \left\{ i \mid 1 \leq i < e, \frac{e}{p-1} < ip^{\eta_i-1} < e \right\} \cup \left\{ i \mid e' < i < 2e \right\}, \\ \Gamma_b &= \left\{ i \mid 1 \leq i < e, e < ip^{\eta_i} < e' \right\} \cup \left\{ i \mid e < i < e' \right\}, \\ \Gamma_c &= \left\{ \frac{e}{p-1}, e' \right\}. \end{aligned}$$

These sets are disjoint to each other, and $\Gamma_a \cup \Gamma_b \cup \Gamma_c$ is coincide with $\{i; 1 \leq i < 2e, i \neq e\}$. Λ is the subset of Γ_a . In this section, we compute $\psi(S_{i,1} \cup S'_{i,2})$ for $i \in \Gamma_a \setminus \Lambda$, $\psi(g_{i,0}(S_{i,1}^0) \cup S_{i,1}^1 \cup S'_{i,2})$ for $i \in \Lambda_0$ and $\psi(g_{i,1}(S_{i,1}^1) \cup S'_{i,2})$ for $i \in \Lambda_1$. We compute $\psi(S_{i,1} \cup S'_{i,2})$ when $i \in \Gamma_b$ in Section 6 and when $i \in \Gamma_c$ in Section 7.

At first, we compute ψ when $i \in \Gamma_a$ and $1 \leq i < e$. Let $e/(p-1) < j < e$, $s = v_p(j) + 1$ and $j_0 = j/p^{s-1}$. Then the integers i which satisfy $ip^{\eta_i-1} = j$ are

$$(i, \eta_i) = (j_0, s), (j_0p, s-1), \dots, (j_0p^{s-1}, 1).$$

Let $i = j_0p^t$. Then $i \in \Gamma_a$ for all t . Notice that if $i \in \Gamma_a$ and $i < e$ then there exists $e/(p-1) < j < e$ such that $ip^{\eta_i-1} = j$.

If $t < \frac{s-1}{2}$ then $S_{i,1} = \emptyset$.

If $t = (s-1)/2$ and $p \mid (j+e)$, then $i \in \Lambda_1$, $S_{i,1}^0 = \emptyset$ and

$$S_{i,1}^1 = X^i \left(pf_{q-2}^{\eta_i-1} N^{q-2} \cup \bigcup_{m=0}^{\eta_i-2} p \frac{d}{p^m} f_{q-3}^m N_0^{q-3} \right).$$

For $X^i p\omega \in S_{i,1}^1$, $\psi(g_{i,1}(X^i p\omega))$ is

$$\begin{aligned} \psi(g_{i,1}(X^i p\omega)) &= \sum_{n \geq 0} \frac{p\pi^{ip^n}}{i^n p^{n+1}} f_{q-1}^n(d\omega) \\ &\quad - \sum_{n \geq 0} \frac{p^{\eta_i-1}}{(i_0+e)p^{n+1}} \pi^{(i_0+e)p^n} f_{q-1}^{\eta_i+n-1}(d\omega) \\ &\quad + \sum_{l=1}^{L-1} \sum_{n \geq 0} \frac{(-1)^l p^{\eta_i+l-1}}{i^n p^n} \pi^{ip^n} f_{q-1}^{\eta_i+l+n-1}(d\omega) \end{aligned} \tag{32}$$

by using (4.3) and the same kind of calculation in (4.4,iv) with the notation (31). If $p\omega \in pf_{q-2}^{\eta_i-1} N^{q-2}$ or $p\omega \in p \frac{d}{p^m} f_{q-3}^m N_0^{q-3}$ for some m , then $\psi(g'_i(X^i p\omega)) = 0$ by (32). If $p\omega \in pf_{q-2}^{\eta_i-1} N_f^{q-2}$, then take $l \geq 0$ and $f_{q-2}^l \omega' \in N_l^{q-2}$ for $\omega' \in N_0^{q-2}$ such that $\omega = f_{q-2}^{\eta_i+l-1}(\omega')$. For this ω' , we have

$$\begin{aligned} \psi(g_{i,1}(X^i pf_{q-2}^{\eta_i+l-1}(\omega'))) &\equiv \begin{cases} \frac{p^l}{i^l} \pi^{ip^{\eta_i-1}} f_{q-1}^{2\eta_i+l-2}(d\omega') & (\text{if } \eta_i \neq 1) \\ \frac{ep^l}{i(i+e)} \pi^i f_{q-1}^l(d\omega') & (\text{if } \eta_i = 1) \end{cases} \\ &\quad \text{mod } \text{fil}^{ip^{\eta_i-1}+el+1}(\hat{\Omega}_A^{q-1}/pd\hat{\Omega}_A^{q-2}). \end{aligned}$$

Now $ip^{\eta_i-1} = j$ and $\eta_i = s-t = (s+1)/2$,

$$\begin{aligned} \psi(g_{i,1}(X^i pf_{q-2}^{\eta_i+l-1}(\omega'))) &\equiv \begin{cases} \frac{p^l}{i^l} \pi^j f_{q-1}^{s+l-1}(d\omega') & (\text{if } s-t > 1) \\ \frac{ep^l}{i(i+e)} \pi^j f_{q-1}^l(d\omega') & (\text{if } t=0, s=1) \end{cases} \\ &\quad \text{mod } \text{fil}^{j+el+1}(\hat{\Omega}_A^{q-1}/pd\hat{\Omega}_A^{q-2}). \end{aligned} \tag{33}$$

If $s = 1$ and $p \mid (j+e)$, then t can be taken only 0. $S_{i,1}^0 = \emptyset$. This i is not in Λ_1 , hence we compute $S_{i,1}^1$ without $g_{i,1}$. Now $S_{i,1}^1 = X^i pN^{q-2}$. For

$X^i p\omega \in X^i pN^{q-2}$,

$$\begin{aligned} \psi(X^i p\omega) &= i\pi^{i-1}d\pi \wedge \omega + i\pi^{ip-e-1}d\pi \wedge f_{q-2}(\omega) \\ &\quad + \sum_{n \geq 0} \frac{1}{p^n} \pi^{ip^n} \wedge f_{q-1}^n(d\omega) \\ &\equiv i\pi^{i-1}d\pi \wedge \omega + \pi^i \wedge d\omega \\ &\quad \text{mod } \text{fil}^{i+1}(\hat{\Omega}_A^{q-1}/pd\hat{\Omega}_A^{q-2}). \end{aligned} \tag{34}$$

If $t = s/2$, then $i \in \Lambda_0$ and

$$S_{i,1}^0 = X^i \left(f_{q-2}^{\eta_i} N^{q-2} \cup \bigcup_{m=0}^{\eta_i-1} p \frac{d}{p^m} f_{q-3}^m N_0^{q-3} \right).$$

For $X^i \omega \in S_{i,1}^0$, $\psi(g_{i,0}(X^i \omega))$ is

$$\begin{aligned} \psi(g_{i,0}(X^i \omega)) &= \sum_{n \geq 0} \frac{\pi^{ip^n}}{i^l p^{n+1}} f_{q-1}^n(d\omega) \\ &\quad - \sum_{n \geq 0} \frac{1}{(i_0 + e)p^{n+1}} \pi^{(i_0+e)p^n} f_{q-1}^n(df_{q-2}^{\eta_i-1}(\omega)) \\ &\quad + \sum_{l=1}^{L-1} \sum_{n \geq 0} \frac{(-1)^l p^{\eta_i+l-1}}{i_l p^n} \pi^{i_l p^n} f_{q-1}^{\eta_i+l+n-1}(d\omega). \end{aligned} \tag{35}$$

If $\omega \in f_{q-2}^{\eta_i} N_\infty^{q-2}$ or $\omega \in \frac{d}{p^m} f_{q-3}^m N_0^{q-3}$ for some m , then $\psi(g_{i,0}(X^i \omega)) = 0$ by (35). If $\omega \in f_{q-2}^{\eta_i} N_f^{q-2}$, then take $l \geq 0$ and $f_{q-2}^l \omega' \in N_l^{q-2}$ for $\omega' \in N_0^{q-2}$ such that $\omega = f_{q-2}^{\eta_i+l}(\omega')$. For this ω' , we have

$$\begin{aligned} \psi(g_{i,0}(X^i f_{q-2}^{\eta_i+l}(\omega'))) &\equiv \frac{p^l}{i^l} \pi^{ip^{\eta_i-1}} f_{q-1}^{2\eta_i+l-1}(d\omega') \\ &\equiv \frac{p^l}{i^l} \pi^j f_{q-1}^{s+l-1}(d\omega') \\ &\quad \text{mod } \text{fil}^{j+el+1}(\hat{\Omega}_A^{q-1}/pd\hat{\Omega}_A^{q-2}). \end{aligned} \tag{36}$$

$S_{i,1}^1$ is

$$S_{i,1}^1 = X^i \left(p f_{q-2}^{\eta_i-1} N^{q-2} \cup \bigcup_{m=0}^{\eta_i-2} p \frac{d}{p^m} f_{q-3}^m N_0^{q-3} \right).$$

For $X^i p\omega \in S_{i,1}^1$, $\psi(X^i p\omega)$ is

$$\psi(X^i p\omega) = \sum_{n \geq 0} \frac{p^{\eta_i-1}}{p^n} \pi^{ip^n} f_{q-1}^n \left(\frac{d\omega}{p^{\eta_i-1}} \right). \tag{37}$$

Thus if $\omega \in f_{q-2}^{\eta_i-1} N_{\infty}^{q-2}$ or $\omega \in \frac{d}{p^m} f_{q-3}^m N_0^{q-3}$ for some m , then $\psi(X^i p\omega) = 0$. If $\omega \in f_{q-2}^{\eta_i-1} N_f^{q-2}$, let $l \geq 0$ and $f_{q-2}^l \omega' \in N_l^{q-2}$ for $\omega' \in N_0^{q-2}$ such that $\omega = f_{q-2}^{\eta_i+l}(\omega')$. For this ω' , we have

$$\begin{aligned} \psi(X^i p f_{q-2}^{\eta_i+l-1}(\omega')) &\equiv p^l \pi^{ip^{\eta_i-1}} f_{q-1}^{2\eta_i+l-2}(d\omega') \\ &\equiv p^l \pi^j f_{q-1}^{s+l-2}(d\omega') \\ &\text{mod } \text{fil}^{j+el+1}(\hat{\Omega}_A^{q-1}/pd\hat{\Omega}_A^{q-2}). \end{aligned} \tag{38}$$

If $t > s/2$, then $i \notin \Lambda$ and

$$S_{i,1}^0 = X^i \left(f_{q-2}^{\eta_i} N^{q-2} \cup \bigcup_{m=0}^{\eta_i-1} p \frac{d}{p^m} f_{q-3}^m N_0^{q-3} \right).$$

For $X^i \omega \in S_{i,1}^0$, $\psi(X^i \omega)$ is

$$\psi(X^i \omega) = \sum_{n \geq 0} \frac{p^{\eta_i}}{p^{n+1}} \pi^{ip^n} f_{q-1}^n \left(\frac{d\omega}{p^{\eta_i}} \right). \tag{39}$$

If $\omega \in f_{q-2}^{\eta_i} N_{\infty}^{q-2}$ or $\omega \in \frac{d}{p^m} f_{q-3}^m N_0^{q-3}$ for some m , then $\psi(X^i \omega) = 0$. If $\omega \in f_{q-2}^{\eta_i} N_f^{q-2}$, then take $l \geq 0$ and $f_{q-2}^l \omega' \in N_l^{q-2}$ for $\omega' \in N_0^{q-2}$ such that $\omega = f_{q-2}^{\eta_i+l}(\omega')$. For this ω' , we have

$$\begin{aligned} \psi(X^i f_{q-2}^{\eta_i+l}(\omega')) &\equiv p^l \pi^{ip^{\eta_i-1}} f_{q-1}^{2\eta_i+l-1}(d\omega') \\ &\equiv p^l \pi^j f_{q-1}^{2s-2t+l-1}(d\omega') \\ &\text{mod } \text{fil}^{j+el+1}(\hat{\Omega}_A^{q-1}/pd\hat{\Omega}_A^{q-2}). \end{aligned} \tag{40}$$

When we take $X^i p\omega \in S_{i,1}^1$, by the same calculation of the case $t = s/2$, we have

$$\begin{aligned} \psi(X^i p f_{q-2}^{\eta_i+l-1}(\omega')) &\equiv p^l \pi^{ip^{\eta_i-1}} f_{q-1}^{2\eta_i+l-2}(d\omega') \\ &\equiv p^l \pi^j f_{q-1}^{2s-2t+l-2}(d\omega') \\ &\text{mod } \text{fil}^{j+el+1}(\hat{\Omega}_A^{q-1}/pd\hat{\Omega}_A^{q-2}). \end{aligned} \tag{41}$$

When $i \in \Gamma_a$ and $i < e$ then $S'_{i,2} = \emptyset$.

Next, we compute $i \in \Gamma_a$ and $e < i$. In this case $S'_{i,2} = \emptyset$, thus we only have to compute $S_{i,1}$. Let $e/(p-1) < j < e$ and $i = j + e$. Then $S_{i,1}^1 = \emptyset$ and $S_{i,1}^0 = X^i N^{q-2}$. For an element $X^i \omega \in S_{i,1}^0$,

$$\psi(X^i \omega) = i\pi^{i-e} \frac{d\pi}{\pi} \wedge \omega + \sum_{n \geq 0} \frac{1}{p^{n+1}} \pi^{ip^n} f_{q-1}^n(d\omega).$$

If $p \mid i$, then the first term of the right hand side is zero. Hence if $\omega = f_{q-2}^l(\omega')$ then

$$\begin{aligned} \psi(X^i\omega) &\equiv p^l \pi^{i-e} f_{q-1}^l(d\omega') \\ &\text{mod } \text{fil}^{j+el+1}(\hat{\Omega}_A^{q-1}/pd\hat{\Omega}_A^{q-2}) \end{aligned} \tag{42}$$

and if $\omega \in N_\infty^{q-2}$ then $\psi(X^i\omega) = 0$. If $p \nmid i$, then

$$\begin{aligned} \psi(X^i\omega) &\equiv i\pi^{i-e} \frac{d\pi}{\pi} \wedge \omega + \pi^{i-e} d\omega \\ &\text{mod } \text{fil}^{j+1}(\hat{\Omega}_A^{q-1}/pd\hat{\Omega}_A^{q-2}). \end{aligned} \tag{43}$$

We have computed all S_i or substitutes of S_i for $i \in \Gamma_a$ as above. Next, we construct the sets $\{M^j\}_{j \geq 0}$ which are rearrangements of the generators of $\psi(H^1(\mathbb{S}_q))$. The law of rearrangement is, for example, as follows. See (33). For an element $g_{i,1}(X^i p f_{q-2}^{\eta_i+l-1}(\omega'))$, the image of ψ is

$$\begin{aligned} \psi(g_{i,1}(X^i p f_{q-2}^{\eta_i+l-1}(\omega'))) &\equiv \frac{p^l}{i'} \pi^j f_{q-1}^{s+l-1}(d\omega') \\ &\text{mod } \text{fil}^{j+el+1}(\hat{\Omega}_A^{q-1}/pd\hat{\Omega}_A^{q-2}) \end{aligned}$$

when $s - t > 1$. Thus this element goes to $\text{gr}^{j+el}(\hat{\Omega}_A^{q-1}/pd\hat{\Omega}_A^{q-2})$ and it seems non-zero. So we put $g_{i,1}(X^i p f_{q-2}^{\eta_i+l-1}(\omega'))$ into M^{j+el} . We will know its image is really non-zero in Section 8 but now we do not know it is true or not. We construct the set M^{j+el} by, roughly speaking, the set of the elements which come to $\text{gr}^{j+el}(\hat{\Omega}_A^{q-1}/pd\hat{\Omega}_A^{q-2})$ and seem non-zero. The real definition of M^* is as follows.

Use (33), (34), (36), (38), (40), (41), (42) and (43) to define M^{j+el} for $e/(p-1) < j < e$ and $l \geq 0$. Let $e/(p-1) < j < e$, $s = v_p(j) + 1$ and $l \geq 0$. If $s = 1$ then let

$$M^{j+el} = \begin{cases} g_{j,1}(X^j p N_0^{q-2}) \cup X^{j+e} N^{q-2} & (p \nmid (j+e) \text{ and } l = 0) \dots (33),(43) \\ g_{j,1}(X^j p f_{q-2}^l N_0^{q-2}) & (p \nmid (j+e) \text{ and } l \geq 1) \dots (33) \\ X^j p N^{q-2} \cup X^{j+e} N_0^{q-2} & (p \mid (j+e) \text{ and } l = 0) \dots (34),(42) \\ X^{j+e} f_{q-2}^l N_0^{q-2} & (p \mid (j+e) \text{ and } l \geq 1) \dots (42). \end{cases} \tag{44}$$

By (3.1), $\text{gr}^j(\hat{\Omega}_A^{q-1}/pd\hat{\Omega}_A^{q-2}) \cong \Omega_F^{q-1} \oplus \Omega_F^{q-2}$ and $\text{gr}^{j+el}(\hat{\Omega}_A^{q-1}/pd\hat{\Omega}_A^{q-2}) \cong \Omega_F^{q-1}/B_l^{q-1}$ for $l \geq 1$. The image of M^j is, if $p \nmid (j+e)$,

$$\begin{aligned} \Omega_F^{q-2}/Z_1^{q-2} &\xrightarrow{\psi \circ g_{j,1} X^j p} \text{gr}^j(\hat{\Omega}_A^{q-1}/pd\hat{\Omega}_A^{q-2}) \xrightarrow{\cong} \Omega_F^{q-1} \oplus \Omega_F^{q-2} \\ \omega &\longmapsto \psi \circ g_{j,1} X^j p \omega = \frac{e}{j+e} \pi^j d\omega \longmapsto \left(\frac{e}{j+e} d\bar{\omega}, 0 \right) \end{aligned}$$

and

$$\begin{aligned} \Omega_F^{q-2} &\xrightarrow{\psi X^{j+e}} \text{gr}^j(\hat{\Omega}_A^{q-1}/pd\hat{\Omega}_A^{q-2}) \xrightarrow{\cong} \Omega_F^{q-1} \oplus \Omega_F^{q-2} \\ \omega &\longmapsto \psi \circ X^{j+e}\omega = \pi^j d\omega + (j+e)\pi^j \frac{d\pi}{\pi} \wedge \omega \longmapsto (d\bar{\omega}, i\bar{\omega}). \end{aligned}$$

Thus we get

$$\begin{aligned} \psi(x) \neq 0 \text{ for } x \in M^j \text{ in } \text{gr}^j(\hat{\Omega}_A^{q-1}/pd\hat{\Omega}_A^{q-2}), \\ \text{gr}^j(\hat{\Omega}_A^{q-1}/pd\hat{\Omega}_A^{q-2})/\langle \psi(M^j) \rangle \cong \Omega_F^{q-1}/B_1^{q-1}. \end{aligned} \tag{45}$$

The case $s = 1$ and $p \mid (j+e)$ goes similarly to the case above. If $l \geq 1$, the image of M^{l+el} in $\text{gr}^{j+el}(\hat{\Omega}_A^{q-1}/pd\hat{\Omega}_A^{q-2}) \cong \Omega_F^{q-1}/B_l^{q-1}$ is

$$\Omega_F^{q-2}/Z_1^{q-2} \ni x \longmapsto C^{-l} dx \in \Omega_F^{q-1}/B_l^{q-1}$$

and hence non-zero. Thus

$$\begin{aligned} \psi(x) \neq 0 \text{ for } x \in M^{j+el} \text{ in } \text{gr}^{j+el}(\hat{\Omega}_A^{q-1}/pd\hat{\Omega}_A^{q-2}), \\ \text{gr}^{j+el}(\hat{\Omega}_A^{q-1}/pd\hat{\Omega}_A^{q-2})/\langle \psi(M^{j+el}) \rangle \cong \Omega_F^{q-1}/B_{l+1}^{q-1}. \end{aligned} \tag{46}$$

If s is even and $s \geq 2$, let

$$M^j = X^{j+e} N^{q-2} \dots \tag{43}$$

$$\cup g_{j_0 p^{\frac{s}{2}}, 0} \left(X^{j_0 p^{\frac{s}{2}}} f_{q-2}^{\frac{s}{2}} N_0^{q-2} \right) \dots \tag{36}$$

$$\cup X^{j_0 p^{\frac{s}{2}}} p f_{q-2}^{\frac{s}{2}-1} N_0^{q-2} \dots \tag{38}$$

$$\cup \left(\bigcup_{s/2 < t \leq s-1} X^{j_0 p^t} f_{q-2}^{s-t} N_0^{q-2} \cup X^{j_0 p^t} p f_{q-2}^{s-t-1} N_0^{q-2} \right) \dots \tag{40}, \tag{41}, \tag{47}$$

and

$$M^{j+el} =$$

$$g_{j_0 p^{\frac{s}{2}}, 0} \left(X^{j_0 p^{\frac{s}{2}}} f_{q-2}^{\frac{s}{2}+l} N_0^{q-2} \right) \dots \tag{36}$$

$$\cup X^{j_0 p^{\frac{s}{2}}} p f_{q-2}^{\frac{s}{2}+l-1} N_0^{q-2} \dots \tag{38}$$

$$\cup \left(\bigcup_{s/2 < t \leq s-1} X^{j_0 p^t} f_{q-2}^{s-t+l} N_0^{q-2} \cup X^{j_0 p^t} p f_{q-2}^{s-t+l-1} N_0^{q-2} \right) \dots \tag{40}, \tag{41}, \tag{48}$$

for $l \geq 1$. The image of (43) is the image of

$$\Omega_F^{q-1} \ni x \xrightarrow{(d,i)} (dx, ix) \in \Omega_F^{q-1} \oplus \Omega_F^{q-2}$$

and the image of (36), (38) and (40) is

$$\frac{\Omega_F^{q-1}/Z_1^{q-1} \oplus \Omega_F^{q-1}/Z_1^{q-1} \oplus \bigoplus_{s/2 < t \leq s-1} (\Omega_F^{q-1}/Z_1^{q-1} \oplus \Omega_F^{q-1}/Z_1^{q-1})}{C^{-(s-1)d} \oplus C^{-(s-2)d} \oplus \bigoplus_{s/2 < t \leq s-1} (C^{-(2s-2t-1)} \oplus C^{-(2s-2t-2)})} \rightarrow B_s^{q-1} \oplus 0 \subset \Omega_F^{q-1} \oplus \Omega_F^{q-2}.$$

Thus we get

$$\begin{aligned} \psi(x) \neq 0 \text{ for } x \in M^j \text{ in } \text{gr}^j(\hat{\Omega}_A^{q-1}/pd\hat{\Omega}_A^{q-2}), \\ \text{gr}^j(\hat{\Omega}_A^{q-1}/pd\hat{\Omega}_A^{q-2})/\langle \psi(M^j) \rangle \cong \Omega_F^{q-1}/B_s^{q-1}. \end{aligned} \tag{49}$$

If $l \geq 1$, the image of M^{j+el} is

$$\frac{\Omega_F^{q-1}/Z_1^{q-1} \oplus \Omega_F^{q-1}/Z_1^{q-1} \oplus \bigoplus_{s/2 < t \leq s-1} (\Omega_F^{q-1}/Z_1^{q-1} \oplus \Omega_F^{q-1}/Z_1^{q-1})}{C^{-(s+l-1)} \oplus C^{-(s+l-2)} \oplus \bigoplus_{s/2 < t \leq s-1} (C^{-(2s-2t+l-1)} \oplus C^{-(2s-2t+l-2)})} \rightarrow B_{s+l}^{q-1}/B_l^{q-1} \subset \Omega_F^{q-1}/B_l^{q-1}.$$

Thus we get

$$\begin{aligned} \psi(x) \neq 0 \text{ for } x \in M^{j+el} \text{ in } \text{gr}^{j+el}(\hat{\Omega}_A^{q-1}/pd\hat{\Omega}_A^{q-2}), \\ \text{gr}^{j+el}(\hat{\Omega}_A^{q-1}/pd\hat{\Omega}_A^{q-2})/\langle \psi(M^{j+el}) \rangle \cong \Omega_F^{q-1}/B_{s+l}^{q-1}. \end{aligned} \tag{50}$$

If s is odd and $s \geq 3$, let

$$M^j = X^{j+e} N^{q-2} \dots \tag{43}$$

$$\cup g_{j_0 p^{\frac{s-1}{2}}, 1} \left(X^{j_0 p^{\frac{s-1}{2}}} p f_{q-2}^{\frac{s-1}{2}-1} N_0^{q-2} \right) \dots \tag{33}$$

$$\cup \left(\bigcup_{s/2 < t \leq s-1} X^{j_0 p^t} f_{q-2}^{s-t} N_0^{q-2} \cup X^{j_0 p^t} p f_{q-2}^{s-t-1} N_0^{q-2} \right) \dots \tag{40}, \tag{41},$$

(51)

and

$$M^{j+el} =$$

$$g_{j_0 p^{\frac{s-1}{2}}, 1} \left(X^{j_0 p^{\frac{s-1}{2}}} p f_{q-2}^{\frac{s-1}{2}+l-1} N_0^{q-2} \right) \dots \tag{33}$$

$$\cup \left(\bigcup_{s/2 < t \leq s-1} X^{j_0 p^t} f_{q-2}^{s-t+l} N_0^{q-2} \cup X^{j_0 p^t} p f_{q-2}^{s-t+l-1} N_0^{q-2} \right) \dots \tag{40}, \tag{41},$$

(52)

for $l \geq 1$. By the similar calculation as the case s is even, we get the same results (49) and (50).

By the definition of M^{j+el} ,

$$\left(\bigcup_{i \in \Gamma_a \setminus \Lambda} S_{i,1}^0 \cup S_{i,1}^1 \right) \cup \left(\bigcup_{i \in \Lambda_0} g_{i,0} S_{i,1}^0 \cup S_{i,1}^1 \right) \cup \left(\bigcup_{i \in \Lambda_1} g_{i,1} S_{i,1}^1 \right) \cup \left(\bigcup_{i \in \Gamma_a} S'_{i,2} \right)$$

is equal to the union of M^{j+el} for all $e/(p-1) < j < e$ and all $l \geq 0$.

6 EXPLICIT CALCULATION, CASE (b)

In this section, we compute $\psi(S_{i,1})$ and $\psi(S'_{i,2})$ for $i \in \Gamma_b$.

At first, we compute ψ when $i \in \Gamma_b$ and $1 \leq i < e$. Let $e < j < e'$, $s = v_p(j)$ and $j_0 = j/p^s$. Then the integers i which satisfy $ip^{\eta_i} = j$ are

$$(i, \eta_i) = (j_0, s), (j_0 p, s-1), \dots, (j_0 p^{s-1}, 1).$$

Let $i = j_0 p^t$. Then $i \in \Gamma_b$ for all t . Notice that if $i \in \Gamma_b$ and $i < e$ then there exists $e < j < e'$ such that $ip^{\eta_i} = j$. But if $s = 0$ then there is no $i \in \Gamma_b$ such that $i < e$ and $ip^{\eta_i} = j$. Thus we assume $s \geq 1$ to calculate when $i < e$.

If $t < \frac{s-1}{2}$ then $S_{i,1} = \emptyset$.

If $t = (s-1)/2$, then $S_{i,1}^0 = \emptyset$ and

$$S_{i,1}^1 = X^i \left(p f_{q-2}^{\eta_i-1} N^{q-2} \cup \bigcup_{m=0}^{\eta_i-2} p \frac{d}{p^m} f_{q-3}^m N_0^{q-3} \right).$$

For $X^i p\omega \in S_{i,1}^1$, $\psi(X^i p\omega)$ is

$$\begin{aligned} \psi(X^i p\omega) &= j_0 \pi^{j_0 p^{s-1}} \frac{d\pi}{\pi} \wedge f_{q-2}^{\frac{s-1}{2}}(\omega) + j_0 \pi^{j-e} \frac{d\pi}{\pi} \wedge f_{q-2}^{\frac{s+1}{2}}(\omega) \\ &\quad + \sum_{n \geq 0} \frac{1}{p^n} \pi^{ip^n} f_{q-1}^n(d\omega) \\ &\equiv j_0 \pi^{j-e} \frac{d\pi}{\pi} \wedge f_{q-2}^{\frac{s+1}{2}}(\omega) + \pi^{j-e} f_{q-2}^{\frac{s+1}{2}} \left(\frac{d\omega}{p^{\frac{s-1}{2}}} \right) \\ &\quad \text{mod } \text{fil}^{j-e+1}(\hat{\Omega}_A^{q-1}/pd\hat{\Omega}_A^{q-2}). \end{aligned} \tag{53}$$

Note that if $X^i p\omega \in S_{i,1}^1$ then $\omega \in \mathfrak{Z}_{\eta_i-1} \hat{\Omega}_{A_0}^{q-2}$.

If $t = s/2$, then

$$S_{i,1}^0 = X^i \left(f_{q-2}^{\eta_i} N^{q-2} \cup \bigcup_{m=0}^{\eta_i-1} \frac{d}{p^m} f_{q-3}^m N_0^{q-3} \right)$$

and

$$S_{i,1}^1 = X^i \left(p f_{q-2}^{\eta_i-1} N^{q-2} \cup \bigcup_{m=0}^{\eta_i-2} p \frac{d}{p^m} f_{q-3}^m N_0^{q-3} \right).$$

For $X^i\omega \in S_{i,1}^0$, $\psi(X^i\omega)$ is

$$\begin{aligned} \psi(X^i\omega) &\equiv j_0\pi^{j-e}\frac{d\pi}{\pi} \wedge f_{q-2}^{\frac{s}{2}}(\omega) + \pi^{j-e}f_{q-1}^{\frac{s}{2}}\left(\frac{d\omega}{p^{\frac{s}{2}}}\right) \\ &\text{mod } \text{fil}^{j-e+1}(\hat{\Omega}_A^{q-1}/pd\hat{\Omega}_A^{q-2}). \end{aligned} \tag{54}$$

For $X^ip\omega \in S_{i,1}^1$, $\psi(X^ip\omega)$ is

$$\psi(X^ip\omega) = \sum_{n \geq 0} \frac{1}{p^n} \pi^{ip^n} f_{q-2}^n(d\omega).$$

Thus if $X^ip\omega \in S_{i,1}^1 \setminus X^ipf_{q-2}^{\eta_i-1}N_f^{q-2}$ then $\psi(X^ip\omega) = 0$. Take $\omega' \in N_0^{q-2}$ such that $\omega = f_{q-2}^{\eta_i-1}f_{q-2}^l\omega'$. Then

$$\begin{aligned} \psi(X^ip\omega) &\equiv p^l\pi^{j-e}f_{q-1}^{s-1+l}d\omega' \\ &\text{mod } \text{fil}^{j-e+el+1}(\hat{\Omega}_A^{q-1}/pd\hat{\Omega}_A^{q-2}). \end{aligned} \tag{55}$$

If $t > s/2$, then

$$S_{i,1}^0 = X^i \left(f_{q-2}^{\eta_i}N^{q-2} \cup \bigcup_{m=0}^{\eta_i-1} p\frac{d}{p^m}f_{q-3}^mN_0^{q-3} \right)$$

and

$$S_{i,1}^1 = X^i \left(pf_{q-2}^{\eta_i-1}N^{q-2} \cup \bigcup_{m=0}^{\eta_i-2} p\frac{d}{p^m}f_{q-3}^mN_0^{q-3} \right).$$

For $X^i\omega \in S_{i,1}^0$, $\psi(X^i\omega)$ is

$$\psi(X^i\omega) = \sum_{n \geq 0} \frac{1}{p^{n+1}} \pi^{ip^n} f_{q-2}^n(d\omega).$$

Thus if $X^i\omega \in S_{i,1}^0 \setminus X^if_{q-2}^{\eta_i}N_f^{q-2}$ then $\psi(X^i\omega) = 0$. Take $\omega' \in N_0^{q-2}$ such that $\omega = f_{q-2}^{\eta_i}f_{q-2}^l\omega'$. Then

$$\begin{aligned} \psi(X^i\omega) &\equiv p^l\pi^{j-e}f_{q-1}^{2s-2t+l}d\omega' \\ &\text{mod } \text{fil}^{j-e+el+1}(\hat{\Omega}_A^{q-1}/pd\hat{\Omega}_A^{q-2}). \end{aligned} \tag{56}$$

For $X^ip\omega \in S_{i,1}^1$, by the same calculation as in the case $t = s/2$,

$$\begin{aligned} \psi(X^ip\omega) &\equiv p^l\pi^{j-e}f_{q-1}^{2s-2t+l-1}d\omega' \\ &\text{mod } \text{fil}^{j-e+el+1}(\hat{\Omega}_A^{q-1}/pd\hat{\Omega}_A^{q-2}). \end{aligned} \tag{57}$$

Next, we compute $S'_{i,2}$ in the case $i \in \Gamma_b$ and $i < e$. By (4.5), $S'_{i,2}$ (resp. $S'_{i,2}$) exists when $3s/4 < t$ (resp. $(3s - 2)/4 < t$). If $3s/4 < t$,

$$\begin{aligned} S'_{i,2} &= X^i \frac{dX}{X} \wedge f_{q-3}^{\eta_i} N_0^{q-3} \ni X^i \frac{dX}{X} \wedge f_{q-3}^{\eta_i}(\omega) \\ &\longmapsto \psi(X^i \frac{dX}{X} \wedge f_{q-3}^{\eta_i}(\omega)) \\ &= \pi^{ip^{\eta_i-1}} \frac{d\pi}{\pi} \wedge f_{q-2}^{2\eta_i-1}(d\omega) + \frac{1}{p} \pi^{ip^{\eta_i}} \frac{d\pi}{\pi} \wedge f_{q-2}^{2\eta_i}(d\omega) \\ &\equiv \pi^{j-e} \frac{d\pi}{\pi} \wedge f_{q-2}^{2s-2t}(d\omega) \\ &\quad \text{mod } \text{fil}^{j-e+1}(\hat{\Omega}_A^{q-1}/pd\hat{\Omega}_A^{q-2}). \end{aligned} \tag{58}$$

If $(3s - 2)/4 < t$,

$$\begin{aligned} S'_{i,2} &= X^i \frac{dX}{X} \wedge pf_{q-3}^{\eta_i-1} N_0^{q-3} \ni X^i \frac{dX}{X} \wedge pf_{q-3}^{\eta_i-1}(\omega) \\ &\longmapsto \psi(X^i \frac{dX}{X} \wedge pf_{q-3}^{\eta_i-1}(\omega)) \\ &= \pi^{ip^{\eta_i-1}} \frac{d\pi}{\pi} \wedge f_{q-2}^{2\eta_i-2}(d\omega) + \frac{1}{p} \pi^{ip^{\eta_i}} \frac{d\pi}{\pi} \wedge f_{q-2}^{2\eta_i-1}(d\omega) \\ &\equiv \pi^{j-e} \frac{d\pi}{\pi} \wedge f_{q-2}^{2s-2t-1}(d\omega) \\ &\quad \text{mod } \text{fil}^{j-e+1}(\hat{\Omega}_A^{q-1}/pd\hat{\Omega}_A^{q-2}). \end{aligned} \tag{59}$$

Next, we compute $S_{i,1}$ for $i \in \Gamma_b$ and $i > e$. Let $j = i$. Now $S_{i,1}^1 = \emptyset$ and $S_{i,1}^0 = X^i N^{q-2}$. For an element $X^i \omega \in S_{i,1}^0$,

$$\psi(X^i \omega) = i\pi^{i-e-1} d\pi \wedge \omega + \sum_{n \geq 0} \frac{1}{p^{n+1}} \pi^{ip^n} f_{q-1}^n(d\omega).$$

If $p \mid i$, then the first term of the right hand side is zero. Hence if $\omega = f_{q-2}^l(\omega')$ then

$$\begin{aligned} \psi(X^i \omega) &\equiv p^l \pi^{i-e} f_{q-1}^l(d\omega') \\ &\quad \text{mod } \text{fil}^{j-e+el+1}(\hat{\Omega}_A^{q-1}/pd\hat{\Omega}_A^{q-2}) \end{aligned} \tag{60}$$

and if $\omega \in N_\infty^{q-2}$ then $\psi(X^i \omega) = 0$. If $p \nmid i$, then

$$\begin{aligned} \psi(X^i \omega) &\equiv i\pi^{i-e} \frac{d\pi}{\pi} \wedge \omega + \pi^{i-e} d\omega \\ &\quad \text{mod } \text{fil}^{j-e+1}(\hat{\Omega}_A^{q-1}/pd\hat{\Omega}_A^{q-2}). \end{aligned} \tag{61}$$

For $i \in \Gamma_b$ and $i > e$, $S'_{i,2}$ is empty if $p \nmid i$. So assume $p \mid i$. Then, for

$$X^{i-1}dX \wedge \omega \in X^{i-1}dX \wedge N_0^{q-3} = S'_{i,2} = S'^0_{i,2},$$

$$\begin{aligned} X^i \frac{dX}{X} \wedge \omega &= \pi^{i-e} \frac{d\pi}{\pi} \wedge d\omega \\ &\equiv \pi^{j-e} \frac{d\pi}{\pi} \wedge d\omega \pmod{\text{fil}^{j-e+1}(\hat{\Omega}_A^{q-1}/pd\hat{\Omega}_A^{q-2})}. \end{aligned} \tag{62}$$

Use (53), (54), (55), (56), (57), (58), (59), (60), (61) and (62) to define M^{j+el} for $e < j < e'$ and $l \geq 0$. Let $e < j < e'$, $s = v_p(j)$. By (3.1),

$$\text{gr}^{j-e+el}(\hat{\Omega}_A^{q-1}/pd\hat{\Omega}_A^{q-2}) \cong \begin{cases} \hat{\Omega}_F^{q-1} \oplus \Omega_F^{q-2} & (l = 0) \\ \hat{\Omega}_F^{q-1}/B_l^{q-1} & (l \geq 1). \end{cases}$$

If $s = 0$ then let

$$\begin{aligned} M^{j-e} &= X^j N^{q-2}, \dots \tag{61} \\ M^{j-e+el} &= \emptyset \end{aligned} \tag{63}$$

for all $l \geq 0$. The image of M^{j-e} is the image of

$$\Omega_F^{q-2} \ni x \longmapsto (dx, jx) \in \Omega_F^{q-1} \oplus \Omega_F^{q-2},$$

hence we get

$$\begin{aligned} \psi(x) \neq 0 \text{ for } x \in M^{j-e} \text{ in } \text{gr}^{j-e}(\hat{\Omega}_A^{q-1}/pd\hat{\Omega}_A^{q-2}), \\ \text{gr}^{j-e}(\hat{\Omega}_A^{q-1}/pd\hat{\Omega}_A^{q-2})/\langle \psi(M^{j-e}) \rangle \\ \cong \text{Coker} \left(\Omega_F^{q-2} \ni x \longmapsto (dx, jx) \in \Omega_F^{q-1} \oplus \Omega_F^{q-2} \right) \end{aligned} \tag{64}$$

and

$$\begin{aligned} \psi(x) \neq 0 \text{ for } x \in M^{j-e+el} \text{ in } \text{gr}^{j-e+el}(\hat{\Omega}_A^{q-1}/pd\hat{\Omega}_A^{q-2}), \\ \text{gr}^{j-e+el}(\hat{\Omega}_A^{q-1}/pd\hat{\Omega}_A^{q-2})/\langle \psi(M^{j-e+el}) \rangle \cong \Omega_F^{q-1}/B_l^{q-1} \end{aligned} \tag{65}$$

for $l \geq 1$ because $M^{j-e+el} = \emptyset$.

If s is even and $s \geq 2$, let

$$\begin{aligned}
 M^{j-e} = & \\
 & X^{j_0 p^{\frac{s}{2}}} \left(f_{q-2}^{\frac{s}{2}} N^{q-2} \cup \bigcup_{m=0}^{(s/2)-1} \frac{d}{p^m} f_{q-3}^m N_0^{q-3} \right) \dots \quad (54) \\
 & \cup X^{j_0 p^{\frac{s}{2}}} p f_{q-2}^{(s/2)-1} N_0^{q-2} \dots \quad (55) \\
 & \cup \bigcup_{\frac{s}{2} < t \leq s-1} \left(X^{j_0 p^t} f_{q-2}^{s-t} N_0^{q-2} \cup X^{j_0 p^t} f_{q-2}^{s-t-1} N_0^{q-2} \right) \dots \quad (56), (57) \\
 & \cup \bigcup_{\frac{3s}{4} < t \leq s-1} \left(X^{j_0 p^t} \frac{dX}{X} f_{q-3}^{s-t} N_0^{q-3} \right) \dots \quad (58) \\
 & \cup \bigcup_{\frac{3s-2}{4} < t \leq s-1} \left(X^{j_0 p^t} \frac{dX}{X} p f_{q-3}^{s-t-1} N_0^{q-3} \right) \dots \quad (59) \\
 & \cup X^j N_0^{q-2} \dots \quad (60) \\
 & \cup X^j \frac{dX}{X} N_0^{q-3} \dots \quad (62)
 \end{aligned} \tag{66}$$

and

$$\begin{aligned}
 M^{j-e+el} = & \\
 & X^{j_0 p^{\frac{s}{2}}} p f_{q-2}^{(s/2)-1} N_l^{q-2} \dots \quad (55) \\
 & \cup \bigcup_{\frac{s}{2} < t \leq s-1} \left(X^{j_0 p^t} f_{q-2}^{s-t} N_l^{q-2} \cup X^{j_0 p^t} f_{q-2}^{s-t-1} N_l^{q-2} \right) \dots \quad (56), (57) \tag{67} \\
 & \cup X^j N_l^{q-2} \dots \quad (60)
 \end{aligned}$$

for $l \geq 1$. When $l = 0$, the image of (58), (59) and (62) is

$$\begin{aligned}
 & \left(\bigoplus_{3s/4 < t \leq s-1} \Omega_F^{q-3} / Z_1^{q-3} \right) \oplus \left(\bigoplus_{3s/4 < t \leq s-1} \Omega_F^{q-3} / Z_1^{q-3} \right) \oplus \Omega_F^{q-3} / Z_1^{q-3} \\
 & \underbrace{\left(\bigoplus_{3s/4 < t \leq s-1} C^{-(2s-2t)} d \right) \oplus \left(\bigoplus_{(3s-2)/4 < t \leq s-1} C^{-(2s-2t-1)} d \right) \oplus d}_{\rightarrow} \\
 & 0 \oplus B_{\frac{s}{2}}^{q-2} \subset \Omega_F^{q-1} \oplus \Omega_F^{q-2},
 \end{aligned}$$

the image of (55), (56), (57) and (60) is

$$\begin{aligned}
 & \Omega_F^{q-2} / Z_1^{q-2} \oplus \left(\bigoplus_{\frac{s}{2} < t \leq s-1} \Omega_F^{q-2} / Z_1^{q-2} \oplus \Omega_F^{q-2} / Z_1^{q-2} \right) \oplus \Omega_F^{q-2} / Z_1^{q-2} \\
 & \underbrace{C^{-(s-1)} d \oplus \left(\bigoplus_{\frac{s}{2} < t \leq s-1} C^{-(2s-2t)} d \oplus C^{-(2s-2t-1)} d \right) \oplus d}_{\rightarrow} \\
 & B_s^{q-1} \oplus 0 \subset \Omega_F^{q-1} \oplus \Omega_F^{q-2}.
 \end{aligned}$$

Furthermore, the image of (54) modulo the image of the group generated by the other generators of M^j is

$$\Omega_F^{q-2} \oplus \left(\bigoplus_{0 \leq m < \frac{s}{2}} \Omega_F^{q-3} / Z_1^{q-3} \right) \xrightarrow{(C^{-s} d, j_0 C^{-s}) \oplus \left(\bigoplus_{0 \leq m < \frac{s}{2}} C^{-(\frac{s}{2}+m)} d \right)} (C^{-s} d, j_0 C^{-s}) \Omega_F^{q-2} + B_s^{q-2} / B_{\frac{s}{2}}^{q-2} \subset \Omega_F^{q-1} / B_s^{q-1} \oplus \Omega_F^{q-2} / B_{\frac{s}{2}}^{q-2}.$$

Hence we get

$$\begin{aligned} &\psi(x) \neq 0 \text{ for } x \in M^{j-e} \text{ in } \text{gr}^{j-e}(\hat{\Omega}_A^{q-1} / pd\hat{\Omega}_A^{q-2}), \\ &\text{gr}^{j-e}(\hat{\Omega}_A^{q-1} / pd\hat{\Omega}_A^{q-2}) / \langle \psi(M^{j-e}) \rangle \\ &\cong \text{Coker} \left(\Omega_F^{q-2} \ni x \mapsto (C^{-s} dx, j_0 C^{-s} x) \in \Omega_F^{q-1} / B_s^{q-1} \oplus \Omega_F^{q-2} / B_{\frac{s}{2}}^{q-2} \right). \end{aligned} \tag{68}$$

When $l \geq 1$, the image of M^{j-e+el} is

$$\begin{aligned} &\Omega_F^{q-2} / Z_1^{q-2} \oplus \left(\bigoplus_{\frac{s}{2} < t \leq s-1} \Omega_F^{q-2} / Z_1^{q-2} \oplus \Omega_F^{q-2} / Z_1^{q-2} \right) \oplus \Omega_F^{q-2} / Z_1^{q-2} \\ &\xrightarrow{C^{-(s+l-1)} d \oplus \left(\bigoplus_{\frac{s}{2} < t \leq s-1} C^{-(2s-2t+l)} d \oplus C^{-(2s-2t+l-1)} \right) \oplus C^{-l} d} B_{s+l}^{q-1} / B_l^{q-1} \subset \Omega_F^{q-1} / B_l^{q-1}. \end{aligned}$$

Hence we get

$$\begin{aligned} &\psi(x) \neq 0 \text{ for } x \in M^{j-e+el} \text{ in } \text{gr}^{j-e+el}(\hat{\Omega}_A^{q-1} / pd\hat{\Omega}_A^{q-2}), \\ &\text{gr}^{j-e+el}(\hat{\Omega}_A^{q-1} / pd\hat{\Omega}_A^{q-2}) / \langle \psi(M^{j-e+el}) \rangle \cong \Omega_F^{q-1} / B_{s+l}^{q-1}. \end{aligned} \tag{69}$$

If s is odd and $s \geq 1$, let

$$M^{j-e} = X^{j_0 p^{\frac{s-1}{2}}} \left(pf_{q-2}^{\frac{s-1}{2}} N^{q-2} \cup \bigcup_{m=0}^{((s-1)/2)-1} p \frac{d}{p^m} f_{q-3}^m N_0^{q-3} \right) \dots \tag{53}$$

$$\cup \bigcup_{\frac{s}{2} < t \leq s-1} \left(X^{j_0 p^t} f_{q-2}^{s-t} N_0^{q-2} \cup X^{j_0 p^t} f_{q-2}^{s-t-1} N_0^{q-2} \right) \dots \tag{56}, \tag{57}$$

$$\cup \bigcup_{\frac{3s}{4} < t \leq s-1} \left(X^{j_0 p^t} \frac{dX}{X} f_{q-3}^{s-t} N_0^{q-3} \right) \dots \tag{58} \tag{70}$$

$$\cup \bigcup_{\frac{3s-2}{4} < t \leq s-1} \left(X^{j_0 p^t} \frac{dX}{X} p f_{q-3}^{s-t-1} N_0^{q-3} \right) \dots \tag{59}$$

$$\cup X^j N_0^{q-2} \dots \tag{60}$$

$$\cup X^j \frac{dX}{X} N_0^{q-3} \dots \tag{62}$$

and

$$M^{j-e+el} = \bigcup_{\frac{s}{2} < t \leq s-1} \left(X^{j_0 p^t} f_{q-2}^{s-t} N_l^{q-2} \cup X^{j_0 p^t} f_{q-2}^{s-t-1} N_l^{q-2} \right) \dots \quad (56), (57)$$

$$\cup X^j N_l^{q-2} \dots \quad (60) \tag{71}$$

for $l \geq 1$. By the similar calculation to the case s is even, we get the same result (68) and (69).

By the definition of M^{j+el} ,

$$\left(\bigcup_{i \in \Gamma_b} S_{i,1}^0 \cup S_{i,1}^1 \right) \cup \left(\bigcup_{i \in \Gamma_b} S'_{i,2} \right)$$

is equal to the union of M^{j-e+el} for all $e < j < e'$ and all $l \geq 0$.

7 EXPLICIT CALCULATION, CASE (c)

In this section, we compute $\psi(S_{i,1})$ and $\psi(S'_{i,2})$ for $i \in \Gamma_c$.

Γ_c has only two elements, $e/(p-1)$ and e' . At first let $i = e/(p-1)$. Then $S_{i,1}^0 = \emptyset$, $S'_{i,2} = \emptyset$ and

$$S_{i,1}^1 = X^i p N^{q-2}.$$

Note that this i has the property $i = ip - e$. Take $X^i p \omega \in X^i p N^{q-2}$, then

$$\begin{aligned} \psi(X^i p \omega) &= i \pi^i \frac{d\pi}{\pi} \wedge (\omega + f_{q-2}(\omega)) + \pi^i (d\omega + f_{q-1}(d\omega)) \\ &\quad + \sum_{n \geq 2} \frac{1}{p^n} \pi^{ip^n} f_{q-1}^n(d\omega). \end{aligned}$$

If $\omega + f_{q-2}(\omega) \equiv 0 \pmod p$ then the leftmost term of the right hand side vanishes. But $\omega + f_{q-2}(\omega) \equiv 0$ means $\bar{\omega} + C^{-1}\bar{\omega} = 0$ in $\hat{\Omega}_F^{q-2}$, thus $d\omega = 0$ hence $\psi(X^i p \omega) = 0$ by the property of N_0^{q-2} , see (25). So we get

$$\psi(X^i p \omega) \begin{cases} \equiv i \pi^i \frac{d\pi}{\pi} \wedge (\omega + f_{q-2}(\omega)) + \pi^i (d\omega + f_{q-1}(d\omega)) \\ \quad \text{mod } \text{fil}^{i+1}(\hat{\Omega}_A^{q-1}/pd\hat{\Omega}_A^{q-2}) \\ \quad \text{(if } \omega + f_{q-2}(\omega) \not\equiv 0 \pmod p \text{)} \\ = 0 \quad \text{(if } \omega + f_{q-2}(\omega) \equiv 0 \pmod p \text{)} \end{cases} \tag{72}$$

Next, let $i = e'$. Then $S_{i,1}^0 = X^i N_{q-2}$, $S'_{i,2} = X^{i-1} dX \wedge N_0^{q-3}$ and $S_{i,1}^1 = S'_{i,2} = \emptyset$. For $X^i \omega \in X^i N_{q-2}$,

$$\psi(X^i \omega) = \sum_{n \geq 0} \frac{1}{p^{n+1}} \pi^{ip^n} f_{q-1}^n(d\omega).$$

Thus if $\omega \in N_\infty^{q-2}$ then $\psi(X^i\omega) = 0$ and if $\omega = f_{q-2}^l\omega'$ for $\omega' \in N_0^{q-2}$ then

$$\psi(X^i f_{q-2}^l \omega') \equiv p^l \pi^{i-e} f_{q-1}^l(d\omega') \pmod{\text{fil}^{i-e+el+1}(\hat{\Omega}_A^{q-1}/pd\hat{\Omega}_A^{q-2})}. \quad (73)$$

For $X^{i-1}dX \wedge \omega \in X^{i-1}dX \wedge N_0^{q-3}$,

$$\psi(X^{i-1}dX \wedge \omega) = \pi^{i-e} \frac{d\pi}{\pi} \wedge d\omega. \quad (74)$$

Use (72), (73) and (74) to define M^{j+el} for $j = e/(p-1)$ and $l \geq 0$.

$$M^{\frac{e}{p-1}} = X^{\frac{e}{p-1}} p N^{q-2} \setminus \left\{ \omega \mid \omega + f_{q-2}\omega \equiv 0 \pmod{p} \right\} \dots (72)$$

$$\cup X^{e'} N_0^{q-2} \dots (73)$$

$$\cup X^{e'} \frac{dX}{X} \wedge N_0^{q-3} \dots (74)$$

and let

$$M^{\frac{e}{p-1}+el} = X^{e'} N_l^{q-2} \dots (73).$$

By (3.1),

$$\text{gr}^{e/(p-1)+el} \hat{\Omega}_A^{q-1}/pd\hat{\Omega}_A^{q-2} \cong \begin{cases} \Omega_F^{q-1} \oplus \Omega_F^{q-2} & (\text{if } l = 0) \\ \Omega_F^{q-1}/B_l^{q-1} & (\text{if } l \geq 1). \end{cases}$$

When $l = 0$, the image of (73) and (74) is

$$\Omega_F^{q-2}/Z_1^{q-2} \oplus \Omega_F^{q-3}/Z_1^{q-3} \xrightarrow{d \oplus d} \Omega_F^{q-1} \oplus \Omega_F^{q-2}$$

and the image of (72) modulo the subgroup generated by (73) and (74) is

$$\Omega_F^{q-2}/Z_1^{q-2} \xrightarrow{((1+C^{-1})d, \frac{e}{p-1}(1+C^{-1}))} \Omega_F^{q-1}/B_1^{q-1} \oplus \Omega_F^{q-2}/(1+C)B_1^{q-2}.$$

Here $\Omega_F^{q-1}/B_1^{q-1} \cong \Omega_F^{q-1}/(1+C)B_1^{q-1}$ follows from $C(B_1^{q-1}) = 0$. Hence we get

$$\begin{aligned} & \psi(x) \neq 0 \text{ for } x \in M^{e/(p-1)} \text{ in } \text{gr}^{e/(p-1)}(\hat{\Omega}_A^{q-1}/pd\hat{\Omega}_A^{q-2}), \\ & \text{gr}^{e/(p-1)}(\hat{\Omega}_A^{q-1}/pd\hat{\Omega}_A^{q-2})/\langle \psi(M^{e/(p-1)}) \rangle \\ & \cong \text{Coker} \left(\begin{array}{c} \Omega_F^{q-2} \longrightarrow \Omega_F^{q-1}/(1+C)B_1^{q-1} \oplus \Omega_F^{q-2}/(1+C)B_1^{q-2} \\ x \longmapsto \left((1+C)C^{-1}dx, \frac{e}{p-1}(1+C)C^{-1}x \right) \end{array} \right). \end{aligned} \quad (75)$$

When $l \geq 1$, the image of (73) is

$$\Omega_F^{q-2}/Z_1^{q-2} \xrightarrow{C^{-1}d} B_{l+1}^{q-1}/B_l^{q-1} \subset \Omega_F^{q-1}/B_l^{q-1}.$$

Hence we get

$$\begin{aligned} \psi(x) \neq 0 \text{ for } x \in M^{e/(p-1)+el} \text{ in } \text{gr}^{e/(p-1)+el}(\hat{\Omega}_A^{q-1}/pd\hat{\Omega}_A^{q-2}), \\ \text{gr}^{e/(p-1)+el}(\hat{\Omega}_A^{q-1}/pd\hat{\Omega}_A^{q-2})/\langle\psi(M^{e/(p-1)+el})\rangle \cong \Omega_F^{q-1}/B_{l+1}^{q-1}. \end{aligned} \tag{76}$$

By the definition of $M^{e/(p-1)+el}$,

$$\left(\bigcup_{i \in \Gamma_c} S_{i,1}^0 \cup S_{i,1}^1\right) \cup \left(\bigcup_{i \in \Gamma_b} S'_{i,2}\right)$$

is equal to the union of $M^{e/(p-1)+el}$ for all $l \geq 0$.

8 THE STRUCTURE OF THE MILNOR K -GROUP

Proof of Theorem 1.1. At first, assume $\zeta_p \in K$, there exists a prime element π of K such that $\pi^e = p$ and the residue field F has a finite p -base. By the definition of M^n , the union of all M^n for $n \geq 1$ and $n/e \notin \mathbb{Z}$ generates $\psi(H^1(\mathbb{S}_q))$. M^{el} for $l \geq 0$ is not defined yet, so let $M^{el} = \emptyset$. Then M^n is defined for all $n \geq 1$. There is map

$$\left\langle \bigcup_{n \geq i} \psi(M^n) \right\rangle / \left\langle \bigcup_{n \geq i+1} \psi(M^n) \right\rangle \longrightarrow \text{gr}^i(\hat{\Omega}_A^{q-1}/pd\hat{\Omega}_A^{q-2}) \tag{77}$$

for each $i \geq 0$. By the exact sequence of (2.4), if (77) are injective for all $i \geq 0$ then

$$\langle\psi(M^i)\rangle \longrightarrow \text{gr}^i(\hat{\Omega}_A^{q-1}/pd\hat{\Omega}_A^{q-2}) \xrightarrow{\text{exp}_p} \text{gr}^{i+e} K_q^M(K)$$

are also exact for all $i \geq 0$. We already know $\psi(x) \neq 0$ for $x \in M^i$ in $\text{gr}^i(\hat{\Omega}_A^{q-1}/pd\hat{\Omega}_A^{q-2})$ and what is the group $\langle\psi(M^i)\rangle$ in $\text{gr}^i(\hat{\Omega}_A^{q-1}/pd\hat{\Omega}_A^{q-2})$ for all $i \geq 0$ by (45), (46), (49), (50), (64), (65), (68), (69), (75) and (76). The results are as follows:

$$\text{gr}^{j+el}(\hat{\Omega}_A^{q-1}/pd\hat{\Omega}_A^{q-2})/\langle\psi(M^{j+el})\rangle \cong \Omega_F^{q-1}/B_{s+l}^{q-1} \quad \left(\text{if } \frac{e}{p-1} < j < e, l \geq 0\right), \tag{78}$$

where $s = v_p(j) + 1$.

$$\begin{aligned} &\text{gr}^{j-e+el}(\hat{\Omega}_A^{q-1}/pd\hat{\Omega}_A^{q-2})/\langle\psi(M^{j+el})\rangle \\ &\cong \begin{cases} \text{Coker} \left(\begin{array}{c} \Omega_F^{q-2} \rightarrow \Omega_F^{q-1}/B_s^{q-1} \oplus \Omega_F^{q-2}/B_s^{q-2} \\ x \mapsto (C^{-s} dx, j_0 C^{-s} x) \end{array} \right) & (\text{if } e < j < e', l = 0) \\ \Omega_F^{q-1}/B_{s+l}^{q-1} & (\text{if } e < j < e', l \geq 1), \end{cases} \end{aligned} \tag{79}$$

where $s = v_p(j)$ and $j_0 = j/p^s$.

$$\begin{aligned} & \text{gr}^{e/(p-1)+el}(\hat{\Omega}_A^{q-1}pd\hat{\Omega}_A^{q-2})/\langle\psi(M^{e/(p-1)+el})\rangle \\ & \cong \begin{cases} \text{Coker}\left(\begin{matrix} \Omega_F^{q-2} \rightarrow \Omega_F^{q-1}/(1+C)B_1^{q-1} \oplus \Omega_F^{q-2}/(1+C)B_1^{q-2} \\ x \mapsto ((1+C)C^{-1}dx, \frac{e}{p-1}(1+C)C^{-1}x) \end{matrix}\right) & (\text{if } l = 0) \\ \Omega_F^{q-1}/B_{1+l}^{q-1} & (\text{if } l \geq 1). \end{cases} \end{aligned} \tag{80}$$

$$\text{gr}^{el}(\hat{\Omega}_A^{q-1}pd\hat{\Omega}_A^{q-2})/\langle\psi(M^{el})\rangle \cong \text{gr}^{el}(\hat{\Omega}_A^{q-1}pd\hat{\Omega}_A^{q-2}) \cong \Omega_F^{q-1}/B_l^{q-1} \text{ (for } l \geq 0). \tag{81}$$

Let $n \geq 1$ and k be the integer which satisfies $e/(p-1) \leq n - ke < e'$. If $1 \leq n \leq e/(p-1)$, then the results of (79) with $l = 0$ and (80) with $l = 0$ is coincide with the result of [3] by $\text{gr}^{n+e} K_q^M(K) \cong \text{gr}^n(\hat{\Omega}_A^{q-1}/pd\hat{\Omega}_A^{q-2})/\langle\psi(M^n)\rangle$. Let $n > e/(p-1)$. Then (78), (79), (80) and (81) say

$$\text{gr}^n(\hat{\Omega}_A^{q-1}pd\hat{\Omega}_A^{q-2})/\langle\psi(M^n)\rangle \cong \Omega_F^{q-1}/B_{s'+1+k}^{q-1},$$

where $s' = v_p(n - ke)$. Hence we have

$$\text{gr}^{n+e} K_q^M(K) \cong \Omega_F^{q-1}/B_{s'+1+k}^{q-1}$$

and we get Theorem (1.1) by shifting degrees.

We prove Theorem (1.1) in the case K does not contain primitive p -th roots of unity ζ_p or K does not contain a prime element π such that $\pi^e = p$ as follows. Let $L = K(\zeta_p, \sqrt[e]{p})$ and let $m = [L : K]$. Then $p \nmid m$ and the extension L/K is unramified. By using standard norm argument, the composite map

$$\text{gr}^i K_q^M(K) \longrightarrow \text{gr}^{im} K_q^M(L) \xrightarrow{\text{Norm}} \text{gr}^i K_q^M(K)$$

is the multiplication by m , hence injective. Furthermore, F_L/F_K is a finite separable extension, where F_L (resp. F_K) is the residue field of L (resp. K), we get $\Omega_{F_L}^{q-1}/B_l\Omega_{F_L}^{q-1} \cong \Omega_{F_K}^{q-1}/B_l\Omega_{F_K}^{q-1} \otimes_{F_K^{p^l}} F_L$. Thus Theorem (1.1) follows even if $\zeta_p \notin K$.

Lastly, do not assume that the residue field of K has a finite p -base. Then an inductive system of complete discrete valuation fields whose residue fields has a finite p -base and its limit is isomorphic to K exists by [9] Section 1.5. On the other hand, for a purely transcendental extension or a separable extension F'/F ,

$$\Omega_F^q/B_l\Omega_F^q \longrightarrow \Omega_{F'}^q/B_l\Omega_{F'}^q$$

are injective for all q and l because, if F'/F is separable extension, then $\Omega_{F'}^q = F' \otimes_F \Omega_F^q$ and if F'/F is purely transcendental extension $F' = F(T)$ then $\Omega_{F'}^q = (F' \otimes_F \Omega_F^q) \oplus (F' \otimes_F \Omega_F^{q-1} \wedge dT)$. Hence we get Theorem (1.1) by taking inductive limit. \square

To prove Corollary (1.2), we need the following

LEMMA 8.1. *Assume $\zeta_p \in K$. Let $V = \text{Im}(\{\zeta_p, *\}: K_{q-1}^M(K)/p \rightarrow K_q^M(K)^\wedge)$. Then the sequence*

$$\begin{aligned} 0 &\longrightarrow V \cap U^i K_q^M(K)^\wedge \cap p^n K_q^M(K)^\wedge \longrightarrow U^i K_q^M(K)^\wedge \cap p^n K_q^M(K)^\wedge \\ &\longrightarrow U^{i+e} K_q^M(K)^\wedge \cap p^{n+1} K_q^M(K)^\wedge \longrightarrow 0 \end{aligned}$$

is exact for $i > e/(p-1)$.

Proof. Restricting the bottom row of (3) to the filtration of $K_q^M(K)$, we have the exact sequence

$$0 \longrightarrow V \cap U^i K_q^M(K)^\wedge \longrightarrow U^i K_q^M(K)^\wedge \xrightarrow{p} U^{i+e} K_q^M(K)^\wedge \longrightarrow 0$$

and hence we get the exact sequence

$$\begin{aligned} 0 &\longrightarrow V \cap U^i K_q^M(K)^\wedge \cap p^n K_q^M(K)^\wedge \longrightarrow U^i K_q^M(K)^\wedge \cap p^n K_q^M(K)^\wedge \\ &\longrightarrow U^{i+e} K_q^M(K)^\wedge \cap p^{n+1} K_q^M(K)^\wedge. \end{aligned} \tag{82}$$

We only have to show the surjectivity of the last arrow of (82). Take $p^{n+1}x \in U^{i+e} K_q^M(K)^\wedge \cap p^{n+1} K_q^M(K)^\wedge$. By the surjectivity of the multiplication by p map $U^i K_q^M(K)^\wedge \rightarrow U^{i+e} K_q^M(K)^\wedge$, there exists $y \in U^i K_q^M(K)^\wedge$ such that $p(y - p^n x) = 0$. This $y - p^n x$ is a p -torsion element of $K_q^M(K)^\wedge$, thus $y - p^n x \in V \subset U^{e/(p-1)} K_q^M(K)^\wedge$. Hence $p^n x \in U^{e/(p-1)} K_q^M(K)^\wedge$ because $y \in U^i K_q^M(K)^\wedge$. Now $e/(p-1)$ is prime to p , thus $\text{gr}^{e/(p-1)} K_q^M(K)^\wedge \cong \text{gr}^{e/(p-1)}(K_q^M(K)/p^n)$ by [3], and $p^n x$ goes to zero on this map. Hence we get $p^n x \in U^{e/(p-1)+1} K_q^M(K)^\wedge$. Let $j = (e/(p-1)) + 1$. By the definition, all rows and columns in the following commutative diagram are exact:

$$\begin{array}{ccccccc} & & & 0 & & 0 & \\ & & & \downarrow & & \downarrow & \\ 0 & \longrightarrow & \frac{V \cap U_\infty^j \cap (p^n)}{V \cap U_\infty^i \cap (p^n)} & \longrightarrow & \frac{U_\infty^j \cap (p^n)}{U_\infty^i \cap (p^n)} & \xrightarrow{p} & \frac{U_\infty^{j+e} \cap (p^{n+1})}{U_\infty^{i+e} \cap (p^{n+1})} \\ & & \downarrow & & \downarrow & & \downarrow \\ 0 & \longrightarrow & \frac{V \cap U_\infty^j}{V \cap U_\infty^i} & \longrightarrow & \frac{U_\infty^j}{U_\infty^i} & \xrightarrow{p} & \frac{U_\infty^{j+e}}{U_\infty^{i+e}} \longrightarrow 0 \\ & & \downarrow & & \downarrow & & \downarrow \\ 0 & \longrightarrow & \frac{V_{p^n} \cap U_{p^n}^j}{V_{p^n} \cap U_{p^n}^i} & \longrightarrow & \frac{U_{p^n}^j}{U_{p^n}^i} & \xrightarrow{p} & \frac{U_{p^{n+1}}^{j+e}}{U_{p^{n+1}}^{i+e}} \longrightarrow 0 \\ & & & & \downarrow & & \downarrow \\ & & & & 0 & & 0 \end{array}$$

where we denote $V_{p^n} = \text{Im}(V \rightarrow K_q^M(K)/p^n)$, $U_\infty^m = U^m K_q^M(K)^\wedge$, $U_{p^n}^n = U^n(K_q^M(K)/p^n)$ and $(p^n) = p^n K_q^M(K)^\wedge$ only in this diagram. $p^n x$ is in the

middle group of the top row and goes to zero by multiplication by p . Thus there exists $z \in V \cap U^j K_q^M(K) \cap p^n K_q^M(K)^\wedge$ such that $p^n x - z \equiv 0$ modulo $U^i K_q^M(K)^\wedge$. Furthermore, $z \in p^n K_q^M(K)^\wedge$ implies $p^n x - z \in U^i K_q^M(K)^\wedge \cap p^n K_q^M(K)^\wedge$, thus

$$\begin{aligned} U^i K_q^M(K)^\wedge \cap p^n K_q^M(K)^\wedge &\xrightarrow{p} U^{i+e} K_q^M(K)^\wedge \cap p^{n+1} K_q^M(K)^\wedge \\ p^n x - z &\mapsto p^{n+1} x - pz = p^{n+1} x. \end{aligned}$$

Hence surjectivity of the last arrow of (82) follows. □

COROLLARY 8.2. *All rows and columns are exact in the following commutative diagram :*

$$\begin{array}{ccccc} & 0 & & 0 & \\ & \downarrow & & \downarrow & \\ \frac{U^i K_q^M(K)^\wedge \cap p^n K_q^M(K)^\wedge}{U^{i+1} K_q^M(K)^\wedge \cap p^n K_q^M(K)^\wedge} & \longrightarrow & \frac{U^{i+e} K_q^M(K)^\wedge \cap p^{n+1} K_q^M(K)^\wedge}{U^{i+e+1} K_q^M(K)^\wedge \cap p^{n+1} K_q^M(K)^\wedge} & \longrightarrow & 0 \\ & \downarrow & & \downarrow & \\ \text{gr}^i K_q^M(K)^\wedge & \xrightarrow{p} & \text{gr}^{i+e} K_q^M(K)^\wedge & \longrightarrow & 0 \quad (83) \\ & \downarrow & & \downarrow & \\ \text{gr}^i(K_q^M(K)/p^n) & \xrightarrow{p} & \text{gr}^{i+e}(K_q^M(K)/p^{n+1}) & \longrightarrow & 0 \\ & \downarrow & & \downarrow & \\ & 0 & & 0 & \end{array}$$

Proof. Exactness of the top row comes from (8.1). □

Proof of Corollary 1.2. Denote $\text{Ker}(\text{gr}^i K_q^M(K)^\wedge \rightarrow \text{gr}^i K_q^M(K)/p^{n+1})$ by $G_{i,n+1}$. At first, we prove Corollary (1.2) for $e' < i \leq e' + e$. Let $s = v_p(i - e)$ and $i_0 = (i - e)/p^s$. Then we know all $\text{gr}^{i_0 - e} K_q^M(K)^\wedge$ and $\text{gr}^{i_0 - e}(K_q^M(K)/p^n)$ by [3], thus (83) is, if $n \leq s$ and $i \neq e' + e$ then

$$\begin{array}{ccccc} & & & 0 & \\ & & & \downarrow & \\ & & & G_{i,n+1} & \longrightarrow 0 \\ & & & \downarrow & \\ Z_n^{q-1} \oplus Z_n^{q-2} & \longrightarrow & & \Omega_F^{q-1}/B_{s+1}^{q-1} & \longrightarrow 0 \\ & \downarrow & & \downarrow & \\ \frac{\Omega_F^{q-1}/B_s^{q-1} \oplus \Omega_F^{q-2}/B_s^{q-2}}{(C^{-s} d, i_0 C^{-s}) \Omega_F^{q-2}} & \longrightarrow & & \downarrow & \\ & \downarrow & & \text{gr}^i(K_q^M(K)/p^{n+1}) & \longrightarrow 0 \\ & \downarrow & & \downarrow & \\ & 0 & & 0 & \end{array}$$

here all maps are natural maps, and if $n \leq s$ and $i = e' + e$ then

$$\begin{array}{ccccc}
 & & & & 0 \\
 & & & & \downarrow \\
 (1+aC)Z_n^{q-1} \oplus (1+aC)Z_n^{q-2} & \longrightarrow & G_{i,n+1} & \longrightarrow & 0 \\
 \downarrow & & \downarrow & & \\
 \frac{\Omega_F^{q-1}/(1+aC)B_s^{q-1} \oplus \Omega_F^{q-2}/(1+aC)B_s^{q-2}}{((1+aC)C^{-s}d, i_0(1+aC)C^{-s})\Omega_F^{q-2}} & \longrightarrow & \Omega_F^{q-1}/B_{s+1}^{q-1} & \longrightarrow & 0 \\
 \downarrow & & \downarrow & & \\
 \frac{\Omega_F^{q-1}}{(1+aC)Z_n^{q-1}} \oplus \frac{\Omega_F^{q-2}}{(1+aC)Z_n^{q-2}} & \longrightarrow & \text{gr}^i(K_q^M(K)/p^{n+1}) & \longrightarrow & 0 \\
 \downarrow & & \downarrow & & \\
 0 & & 0 & &
 \end{array}$$

where a is the residue class of p/π^e . We get (1.2) in this case by these diagrams. If $n > s$ then $\text{gr}^i K_q^M(K) \rightarrow \text{gr}^i(K_q^M(K)/p^n)$ is an isomorphism, thus $\text{gr}^{i+e} K_q^M(K) \rightarrow \text{gr}^{i+e}(K_q^M(K)/p^{n+1})$ is also an isomorphism.

By induction on i and calculating the diagram (83) for each case, we get (1.2). □

9 AN APPLICATION

THEOREM 9.1. *Let K be a Henselian discrete valuation field of mixed characteristics $(0, p > 2)$ with the residue field F . Assume $p \nmid e$ and $[F : \mathbb{F}_p] = p^{q-1}$, where $e = v_K(p)$. Let L/K be a ferociously ramified cyclic extension of order p^n (i.e., the extension of the residue fields is inseparable of order p^n). Then $p^n \leq e'$, where $e' = ep/(p-1)$.*

Remark 9.2. In [15] and [6], they give the upper bounds of such extensions. If K has the property $p \nmid e$, our bound is stricter than them (or equal to [6] if e is small).

Proof. We use the notation $U_{p^n}^i = U^i(K_q^M(K)/p^n)$ for simplicity. The proof goes similarly to the argument of [15] Section 3. By the limit argument, we may assume F is a field of transcendental degree $q-1$ over \mathbb{F}_p . Then $H^{q+1}(K, \mathbb{Z}/p(q))$ is non zero by [10] and furthermore we know that $H^{q+1}(K, \mathbb{Z}/p^n(q))$ has an elements of order p^n by using Bockstein.

Let L/K be a cyclic extension of order p^n and let $\chi \in H^1(K, \mathbb{Z}/p^n)$ be the character which coincide with L/K . Let ϕ_χ be the homomorphism

$$\phi_\chi : K_q^M(K)/p^n \longrightarrow H^{q+1}(K, \mathbb{Z}/p^n(q))$$

which is induced by the pairing

$$H^1(K, \mathbb{Z}/p^n) \times K_q^M(K)/p^n \longrightarrow H^{q+1}(K, \mathbb{Z}/p^n(q))$$

by using $K_q^M(K)/p^n \cong H^q(K, \mathbb{Z}/p^n(q))$. If L/K is ferociously ramified, by [15] Section 3, we know

$$\phi_\chi : U_{p^n}^1 \longrightarrow H^{q+1}(K, \mathbb{Z}/p^n(q))$$

is surjective and

$$\phi_\chi(\{1 + \pi^i x, y_1, \dots, y_{q-1}\}) \in \phi_\chi(U_{p^n}^{i+1}) \quad (84)$$

for any $x, y_1, \dots, y_{q-1} \in \mathcal{O}_K^\times$ and $i \geq 1$. Theorem (1.1) says that $U_{p^n}^{e'+1}$ is generated by the elements of the form of the left hand side of (84), thus we get

$$\phi_\chi : U_{p^n}^p / U_{p^n}^{e'+1} \longrightarrow H^{q+1}(K, \mathbb{Z}/p^n(q))$$

is defined and surjective. Furthermore, for any element $\{1 + \pi^i x, y_1, \dots, y_{q-2}, \pi\} \in U_{p^n}^1$ for $x, y_1, \dots, y_{q-2} \in \mathcal{O}_K^\times$ and $i \geq p$, its order modulo $U_{p^n}^{e'+1}$ is less than or equal to p^l by [3] Theorem 1.4, where l be the maximal integer which satisfies $p^l \leq e'$. Thus the maximal order of the elements of $U_{p^n}^p$ modulo $U_{p^n}^{e'+1}$ is less than or equal to p^l . On the other hand, $H^{q+1}(K, \mathbb{Z}/p^n(q))$ has a element of order p^n , thus $n \leq l$. This is the inequality which we desired.

Note that there exists elements of $U_{p^n}^p / U_{p^n}^{e'+1}$ of order p^n , for example, $\{1 + \pi^p T_1, T_2, \dots, T_{q-1}, \pi\}$, where $\{T_1, \dots, T_{q-1}\}$ are the liftings of a p -base of F . Thus the maximal order of the elements of $U_{p^n}^p / U_{p^n}^{e'+1}$ is p^l . \square

REFERENCES

- [1] BERTHELOT, P., AND OGUS, A. *Notes on crystalline cohomology*. Princeton University Press, Princeton, 1978.
- [2] BLOCH, S. Algebraic K -theory and crystalline cohomology. *Publ. Math. IHES* 47 (1977), 187–268.
- [3] BLOCH, S., AND KATO, K. p -adic etale cohomology. *Publ. Math. IHES* 63 (1986), 107–152.
- [4] BOURBAKI, N. *Algèbre Commutative*, vol. Chap. 8 et 9. Masson, Paris, 1983.
- [5] GRAHAM, J. Continuous symbols on fields of formal power series. In *Algebraic K-theory II*, vol. 342 of *Lecture Notes in Math*. Springer-Verlag, Berlin, 1973, pp. 474–486.

- [6] HYODO, O. Wild ramification in the imperfect residue field case. In *Galois Representations and Arithmetic Algebraic Geometry*, vol. 12 of *Adv. Stud. in Pure Math.* 1987, pp. 287–314.
- [7] ILLUSIE, L. Complexe de De Rham-Witt et cohomologie cristalline. *Ann. Sci. Ecole Norm. Sup.* 12 (1979), 501–661.
- [8] KAHN, B. L’anneau de Milnor d’un corps local à corps résiduel parfait. *Ann. Inst. Fourier* 34, 4 (1984), 19–65.
- [9] KATO, K. A generalization of local class field theory by using K -groups. II. *J. Fac. Sci. Univ. Tokyo* 27 (1980), 603–683.
- [10] KATO, K. Galois cohomology of complete discrete valuation fields. In *Algebraic K -theory*, vol. 967 of *Lecture Notes in Math.* Springer-Verlag, Berlin, 1982, pp. 215–238.
- [11] KATO, K. On p -adic vanishing cycles (applications of ideas of Fontaine-Messing). In *Algebraic Geometry, Sendai, 1985*, vol. 10 of *Adv. Stud. in Pure Math.* 1987, pp. 207–251.
- [12] KURIHARA, M. The Milnor K -groups of a local ring over a ring of the p -adic integers. to appear in the volume on Ramification theory for arithmetic schemes. Lminy 1999, ed. B. Erez.
- [13] KURIHARA, M. On the structure of the Milnor K -group of a certain complete discrete valuation field. preprint.
- [14] KURIHARA, M. A note on p -adic étale cohomology. *Proc. Japan Acad. (A)* 63 (1987), 275–278.
- [15] KURIHARA, M. On two types of complete discrete valuation fields. *Compositio Math.* 63 (1987), 237–257.
- [16] KURIHARA, M. Abelian extensions of an absolutely unramified local field with general residue field. *Inv. Math.* 93 (1988), 451–480.
- [17] KURIHARA, M. The exponential homomorphisms for the Milnor K -groups and an explicit reciprocity law. *J. Reine Angew. Math.* 498 (1998), 201–221.
- [18] MIKI, H. On F_p -extensions of complete p -adic power series fields and function fields. *J. Fac. Sci., Univ. Tokyo, Sect. IA* 21 (1974), 377–393.
- [19] NAKAMURA, J. On the structure of the Milnor K -groups of some complete discrete valuation fields. *K -Theory* 19, 3 (2000), 269–309.
- [20] ZHUKOV, I. Milnor and topological K -groups of multidimensional complete fields. *St. Petersburg Math. J.* 9 (1998), 69–105.

Jinya Nakamura
Graduate School of
Mathematical Sciences
University of Tokyo
Komaba, Meguro-ku
Tokyo, Japan
jinya@ms357.ms.u-tokyo.ac.jp

NEW UNCERTAINTY PRINCIPLES
FOR THE CONTINUOUS GABOR TRANSFORM
AND THE CONTINUOUS WAVELET TRANSFORM

ELKE WILCZOK

Received: March 4, 1999

Revised: March 3, 2000

Communicated by Alfred K. Louis

ABSTRACT. Gabor and wavelet methods are preferred to classical Fourier methods, whenever the time dependence of the analyzed signal is of the same importance as its frequency dependence. However, there exist strict limits to the maximal time-frequency resolution of these both transforms, similar to Heisenberg's uncertainty principle in Fourier analysis. Results of this type are the subject of the following article. Among else, the following will be shown: if ψ is a window function, $f \in L^2(\mathbf{R}) \setminus \{0\}$ an arbitrary signal and $G_\psi f(\omega, t)$ the continuous Gabor transform of f with respect to ψ , then the support of $G_\psi f(\omega, t)$ considered as a subset of the time-frequency-plane \mathbf{R}^2 cannot possess finite Lebesgue measure. The proof of this statement, as well as the proof of its wavelet counterpart, relies heavily on the well known fact that the ranges of the continuous transforms are reproducing kernel Hilbert spaces, showing some kind of shift-invariance. The last point prohibits the extension of results of this type to discrete theory.

1991 Mathematics Subject Classification: 26D10, 43A32, 46C05, 46E22, 81R30, 81S30, 94A12

Keywords and Phrases: uncertainty principles, wavelets, reproducing kernel Hilbert spaces, phase space

1 INTRODUCTION

One of the basic principles in classical Fourier analysis is the impossibility to find a function f being arbitrarily well localized together with its Fourier transform \hat{f} . There are many ways to get this statement precise. The most famous of them is the so called *Heisenberg uncertainty principle* [Heis27], a consequence of Cauchy-Schwarz's inequality (c.f. [Chan89], for example):

Given $f \in L^2(\mathbf{R}) \setminus \{0\}$ arbitrary, one has

$$\left(\int_{-\infty}^{\infty} x^2 |f(x)|^2 dx \right)^{1/2} \left(\int_{-\infty}^{\infty} \xi^2 |\hat{f}(\xi)|^2 d\xi \right)^{1/2} \geq \frac{\|f\|_{L^2(\mathbf{R})}^2}{2}, \quad (1)$$

where equality holds if and only if there exist some constants $C \in \mathbf{C}$, $k > 0$ such that $f(x) = Ce^{-kx^2}$.

Completely different techniques lead to further restrictions of this type, e.g. methods of complex analysis to the theorems of Paley-Wiener and Hardy [Chan89, Hard33], and a study of the spectral properties of compact operators to the work of Slepian, Pollak and Landau [Slep65, LaWi80, Slep83]. The uncertainty principles of Lenard, Amrein, Berthier and Jauch [Lena72, BeJa76, AmBe77] are mainly consequences of the geometric properties of abstract Hilbert spaces. Additional considerations provide the articles of Cowling-Price [CoPr84] and Donoho-Stark [DoSt89]. And those are just a few aspects of uncertainty in harmonic analysis. Deeper insight can be won from the book of Havin and Jöricke [HaJo94].

The representation of f as a function of x is usually called its *time-representation*, while *frequency-representation* is another name for the Fourier transform $\hat{f}(\xi)$. For applications, one often needs information about the frequency-behaviour of a signal at a certain time (resp. the time-behaviour of a certain frequency-component of the signal). This led to the construction of several *joint time-frequency representations*, among those the Gabor transform (3). The motivation for the wavelet transform (12) was of similar nature. However, the latter should preferably be called a joint time-*scale* representation, since the parameter a in (12) cannot completely be identified with an inverse frequency, as it is often done in the literature.

Bearing in mind the limits of classical Fourier transform, one cannot expect to achieve perfect phase-space resolution by using such joint representations. Even worse, additional perturbations of the original signal may be introduced by the window (resp. wavelet) function ψ . Precise estimates tackling exactly that point are rare in literature. Usually, the time-frequency-resolution of a Gabor (resp. wavelet) transform is identified with the time-frequency localization of the function ψ [Chui92]. This can be seen even more clearly from the discrete transforms: the famous uncertainty principles of Balian-Low for the discrete Gabor transform [Bali81, Daub90] and Battle for the discrete wavelet transform [Batt89, Batt97] just estimate the maximal time-frequency resolution of the window (resp. wavelet) function ψ under the restriction that the daughter functions of ψ span a frame (resp. an – in some suitable sense – orthogonal set). As for the continuous wavelet transform, Dahlke and Maaß [DaMa95] proved a Heisenberg-like inequality related to the affine group. It is not so obvious, however, what consequences for the phase-space localization of $W_{\psi}f$ follow from this result. Presumably, Daubechies [Daub88, Daub92] was the

first to analyze the energy content of $G_\psi f$ (resp. $W_\psi f$) restricted to a proper subset M of phase-space. But she considered only very *special* functions ψ and subsets M of very *special* geometry, chosen in such a way that the arguments of Slepian, Pollak and Landau could widely be transferred.

In section 4 of this article, a similar investigation will be performed for quite *general* functions ψ and almost *arbitrary* subsets M of phase-space. By this, one cannot expect to get such precise results as Daubechies did. While she computed the whole spectrum of a suitably constructed compact operator, we just derive an upper bound for its eigenvalues. This suffices, however, to estimate the maximal energy content of $G_\psi f$ (resp. $W_\psi f$) in M . Before doing so, we show in section 3 that if M is a set of finite Lebesgue (resp. affine) measure, there is no $f \in L^2(\mathbf{R})$ such that $\text{supp } G_\psi f \subseteq M$ (resp. $\text{supp } W_\psi f \subseteq M$). Here, $\text{supp } h$ denotes the support of a given function h . We finish this article with some conclusions following from Heisenberg's uncertainty principle.

The results presented here are part of the author's PhD thesis [Wilc97].

2 PREREQUISITES FROM THE THEORY OF GABOR AND WAVELET TRANSFORMS

This section shall serve as a reference. It provides some of the most important definitions and theorems from the theory of (continuous) Gabor and wavelet transforms. Further introductory information, and especially the proofs of the results presented here, can be found, e.g., in [Chui92, Daub92, Koel94].

In the following, we denote by $\lambda^{(n)}$ n -dimensional Lebesgue measure, by \mathbf{R}^* the set of real numbers without zero and by χ_M the characteristic function of the set M . The Fourier-Plancherel transform of a function $f \in L^2(\mathbf{R})$ is normalized by

$$(\mathcal{F}f)(\xi) := \hat{f}(\xi) := \frac{1}{\sqrt{2\pi}} \int_{-\infty}^{\infty} f(x) e^{-i\xi x} dx \quad (\xi \in \mathbf{R}).$$

2.1 BASIC GABOR THEORY

DEFINITION 2.1 (*Gabor transform*)

1. A *window function* is a function $\psi \in L^2(\mathbf{R}) \setminus \{0\}$.
2. Given a window function ψ and $(\omega, t) \in \mathbf{R}^2$, we define the *daughter function* $\psi_{\omega t}$ of ψ by

$$\psi_{\omega t}(x) := \frac{1}{\sqrt{2\pi}} \psi(x - t) e^{i\omega x}. \quad (2)$$

3. The *Gabor transform (GT)* of a function $f \in L^2(\mathbf{R})$ with respect to the window function ψ is defined by

$$G_\psi f : \mathbf{R}^2 \rightarrow \mathbf{C}, \quad \text{where}$$

$$G_\psi f(\omega, t) := \int_{-\infty}^{\infty} f(x) \overline{\psi_{\omega t}(x)} dx. \quad (3)$$

4. Given a window function ψ , we define an operator G_ψ acting on $L^2(\mathbf{R})$ by

$$G_\psi : f \mapsto G_\psi f.$$

G_ψ is called the *operator of the Gabor transform* or, shorter, *the Gabor transform* with respect to ψ .

REMARK 2.2

1. Other names of the Gabor transform frequently used in the literature are *Weyl-Heisenberg transform*, *short time Fourier transform* and *windowed Fourier transform*.

2. If there is no danger of confusion, we drop the attribute *with respect to ψ* in the following.

3. From Plancherel's formula we get the *Fourier representations* of $G_\psi f$:

$$G_\psi f(\omega, t) = \mathcal{F}(f(x) \overline{\psi(x-t)})(\omega) = e^{-it\omega} \mathcal{F}(\hat{f}(\xi) \overline{\hat{\psi}(\xi-\omega)})(-t). \quad (4)$$

Denoting by $C_b(\mathbf{R}^2)$ the vector space of bounded continuous functions mapping \mathbf{R}^2 into \mathbf{C} , equipped with the maximum norm, we have

THEOREM 2.3 (Covariance properties) *Let ψ be a window function. The Gabor transform G_ψ is a bounded linear operator from $L^2(\mathbf{R})$ to $C_b(\mathbf{R}^2)$ possessing the following covariance properties:*

for $f \in L^2(\mathbf{R})$ and $(\omega, t) \in \mathbf{R}^2$ arbitrary

$$[G_\psi f(\cdot - x_0)](\omega, t) = e^{-i\omega x_0} G_\psi f(\omega, t - x_0) \quad (x_0 \in \mathbf{R}), \quad (5)$$

$$[G_\psi(e^{i\omega_0 \cdot} f(\cdot))](\omega, t) = G_\psi f(\omega - \omega_0, t) \quad (\omega_0 \in \mathbf{R}). \quad (6)$$

THEOREM 2.4 (Orthogonality relation) *Let ψ be a window function and $f, g \in L^2(\mathbf{R})$ arbitrary. Then we have*

$$\int_{-\infty}^{\infty} G_\psi f(\omega, t) \overline{G_\psi g(\omega, t)} d\omega dt = \|\psi\|_{L^2(\mathbf{R})}^2 (f, g)_{L^2(\mathbf{R})}. \quad (7)$$

COROLLARY 2.5 (Isometry) *Let ψ be a window function. The normalized Gabor transform $\frac{1}{\|\psi\|_{L^2(\mathbf{R})}}G_\psi$ is an isometry from $L^2(\mathbf{R})$ into a subspace of $L^2(\mathbf{R}^2)$.*

COROLLARY 2.6 (Reproducing kernel) *Let ψ be a window function. Then $G_\psi(L^2(\mathbf{R}))$ is a reproducing kernel Hilbert space (r.k.H.s.) in $L^2(\mathbf{R}^2)$ with kernel function*

$$K_\psi(\omega', t'; \omega, t) := \frac{1}{\|\psi\|_{L^2(\mathbf{R})}^2} (\psi_{\omega t}, \psi_{\omega' t'})_{L^2(\mathbf{R})}. \quad (8)$$

The kernel is pointwise bounded:

$$|K_\psi(\omega', t'; \omega, t)| \leq 1 \quad \forall (\omega', t'), (\omega, t) \in \mathbf{R}^2. \quad (9)$$

2.2 BASIC WAVELET THEORY

DEFINITION 2.7 (*Wavelet transform*)

1. A function $\psi \in L^2(\mathbf{R}) \setminus \{0\}$ satisfying the *admissibility condition*

$$c_\psi := 2\pi \int_{-\infty}^{\infty} |\hat{\psi}(\xi)|^2 \frac{d\xi}{|\xi|} < \infty \quad (10)$$

is called a *mother wavelet*.

2. Given a mother wavelet ψ and $(a, b) \in \mathbf{R}^* \times \mathbf{R}$, we define the *daughter wavelet* ψ_{ab} of ψ by

$$\psi_{ab}(x) := \frac{1}{\sqrt{|a|}} \psi\left(\frac{x-b}{a}\right). \quad (11)$$

3. The *wavelet transform (WT)* of a function $f \in L^2(\mathbf{R})$ with respect to the mother wavelet ψ is defined by

$$W_\psi f : \mathbf{R}^* \times \mathbf{R} \rightarrow \mathbf{C}, \quad \text{where}$$

$$W_\psi f(a, b) := \int_{-\infty}^{\infty} f(x) \overline{\psi_{ab}(x)} dx. \quad (12)$$

4. Given a mother wavelet ψ , we define an operator W_ψ acting on $L^2(\mathbf{R})$ by

$$W_\psi : f \mapsto W_\psi f.$$

W_ψ is called the *operator of the wavelet transform* or, shorter, *the wavelet transform* with respect to ψ .

REMARK 2.8

From Plancherel's formula we get the *Fourier representation*

$$W_\psi f(a, b) = \mathcal{F}^{-1}(\sqrt{2\pi} \hat{f}(\xi) \sqrt{|a|} \widehat{\psi}(a\xi))(b). \quad (13)$$

Denoting by $C_b(\mathbf{R}^* \times \mathbf{R})$ the vector space of bounded continuous functions mapping \mathbf{R}^2 into \mathbf{C} , equipped with the maximum norm, we have

THEOREM 2.9 (Covariance properties) *Let ψ be a mother wavelet. The wavelet transform W_ψ is a bounded linear operator from $L^2(\mathbf{R})$ to $C_b(\mathbf{R}^* \times \mathbf{R})$ possessing the following covariance properties:*

for $f \in L^2(\mathbf{R})$ and $(a, b) \in \mathbf{R}^* \times \mathbf{R}$ arbitrary

$$[W_\psi f(\cdot - x_0)](a, b) = W_\psi f(a, b - x_0) \quad (x_0 \in \mathbf{R}), \quad (14)$$

$$\left[W_\psi \left(\frac{1}{\sqrt{|c|}} f \left(\frac{\cdot}{c} \right) \right) \right] (a, b) = W_\psi f \left(\frac{a}{c}, \frac{b}{c} \right) \quad (c \in \mathbf{R}^*). \quad (15)$$

THEOREM 2.10 (Orthogonality relation) *Let ψ be a mother wavelet and $f, g \in L^2(\mathbf{R})$ arbitrary. Then we have*

$$\int_{-\infty}^{\infty} W_\psi f(a, b) \overline{W_\psi g(a, b)} \frac{dad b}{a^2} = c_\psi(f, g)_{L^2(\mathbf{R})}. \quad (16)$$

COROLLARY 2.11 (Isometry) *Let ψ be a mother wavelet. The normalized wavelet transform $\frac{1}{\sqrt{c_\psi}} W_\psi$ is an isometry from $L^2(\mathbf{R})$ into a subspace of $L^2(\mathbf{R}^* \times \mathbf{R}, d\mu_{aff})$, where $d\mu_{aff} := \frac{dad b}{a^2}$ denotes the so-called affine measure.*

COROLLARY 2.12 (Reproducing kernel) *Let ψ be a mother wavelet. Then $W_\psi(L^2(\mathbf{R}))$ is a r.k.H.s. in $L^2(\mathbf{R}^* \times \mathbf{R}, d\mu_{aff})$ with kernel function*

$$K_\psi(a', b'; a, b) := \frac{1}{c_\psi} (\psi_{ab}, \psi_{a'b'})_{L^2(\mathbf{R})}. \quad (17)$$

The kernel is pointwise bounded:

$$|K_\psi(a', b'; a, b)| \leq \frac{\|\psi\|_{L^2(\mathbf{R})}^2}{c_\psi} \quad \forall (a', b'), (a, b) \in \mathbf{R}^* \times \mathbf{R}. \quad (18)$$

2.3 GROUP THEORETICAL BACKGROUND

The parallel structures of the two foregoing sections suggest that Gabor and wavelet transform originate from a common root. As it is widely known, this root can be found in the theory of *unitary representations of locally compact groups*. Using the terminology of e.g. [GrMo85, HeWa89] we state one of the central results in that context:

THEOREM 2.13 (Orthogonality relation) *Let G be a locally compact group with left Haar measure μ_L , \mathcal{H} a complex Hilbert space and U a square integrable, irreducible, unitary representation of G on \mathcal{H} . Define*

$$\mathcal{A}_U := \{\psi \in \mathcal{H} : \psi \text{ is } U\text{-admissible}\}, \quad (19)$$

where U -admissibility of $\psi \in \mathcal{H}$ means

$$0 < c_\psi^U := \int_G |(\psi, U(g)\psi)_\mathcal{H}|^2 d\mu_L(g) < \infty. \quad (20)$$

Then \mathcal{A}_U is dense in \mathcal{H} , and there exists a unique positive operator $C_U : \mathcal{A}_U \rightarrow \mathcal{H}$ such that for all $\psi, \Psi \in \mathcal{A}_U$ and for all $f_1, f_2 \in \mathcal{H}$

$$\int_G (f_1, U(g)\psi)_\mathcal{H} \overline{(f_2, U(g)\Psi)_\mathcal{H}} d\mu_L(g) = (C_U \Psi, C_U \psi)_\mathcal{H}(f_1, f_2)_\mathcal{H}. \quad (21)$$

If G is unimodular, then C_U is a multiple of the identity operator.

REMARK 2.14 Gabor transform is induced by a square-integrable, unitary, irreducible representation U_{WH} of the so called *Weyl-Heisenberg group* on $L^2(\mathbf{R})$. Here, U_{WH} -admissibility poses no additional restrictions: $\mathcal{A}_{U_{WH}} = L^2(\mathbf{R})$.

Similarly, wavelet transform results from a representation U_{aff} of the *affine ("ax+b"-) group* on $L^2(\mathbf{R})$. In this case, U_{aff} -admissibility of a function $\psi \in L^2(\mathbf{R})$ corresponds to admissibility in the sense of 10.

By this, covariance properties 5,6,14 and 15, as well as the orthogonality relations 7,16 with corollaries are immediate consequences of group theory.

A helpful reference in the context of time-frequency distributions and group theory is the survey article of Miller [Mill91].

3 RESTRICTIONS ON THE SUPPORTS OF GABOR AND WAVELET TRANSFORMS

In 1977, Amrein and Berthier ([AmBe77], see also [HaJo94]) proved that the support of a function $f \in L^2(\mathbf{R}) \setminus \{0\}$ and the support of its Fourier transform \hat{f} cannot both be sets of finite Lebesgue measure. Using the same techniques, we will show now that for any window function (resp. wavelet) ψ and any $f \in L^2(\mathbf{R}) \setminus \{0\}$ the support of the Gabor transform $G_\psi f$ (resp. wavelet transform $W_\psi f$) is a set of infinite Lebesgue (resp. affine) measure. As a preparation we need

LEMMA 3.1 (Dimension of certain subspaces of a r.k.H.s.)

Let (Y, Σ_Y, μ_Y) be a σ -finite measure space, M a subset of Y with $\mu_Y(M) < \infty$, and $\mathcal{H} \subset L^2(Y, d\mu_Y)$ a r.k.H.s. with kernel K . Assuming that

$$\sup_{y', y \in Y} |K(y', y)| < \infty, \quad (22)$$

and defining

$$\mathcal{H}_M := \{F \in \mathcal{H} : F = \chi_M \cdot F\}, \quad (23)$$

the following estimate holds:

$$\dim \mathcal{H}_M \leq \left(\sup_{y', y \in Y} |K(y', y)| \right)^2 \mu_Y(M)^2 < \infty. \quad (24)$$

Proof: Using (22) and the finiteness of $\mu_Y(M)$ we get

$$\int_M \int_M |K(y', y)|^2 d\mu_Y(y') d\mu_Y(y) \leq \left(\sup_{y', y \in Y} |K(y', y)| \right)^2 \mu_Y(M)^2 < \infty, \quad (25)$$

hence, in particular, $K \in L^2(M \times M, d^2\mu_Y)$. Let $(e_n)_{n=1}^N$ ($N \in \overline{\mathbb{N}}$) be an arbitrary orthonormal family in \mathcal{H}_M , and define

$$\mathcal{E}_n(y', y) := e_n(y') \overline{e_n(y)} \quad (n \in \{1, \dots, N\}).$$

Then for $m, n \in \{1, \dots, N\}$

$$\begin{aligned} & \int_M \int_M \mathcal{E}_m(y', y) \overline{\mathcal{E}_n(y', y)} d\mu_Y(y') d\mu_Y(y) \\ &= \int_M \int_M e_m(y') \overline{e_m(y)} e_n(y') \overline{e_n(y)} d\mu_Y(y') d\mu_Y(y) = \delta_{mn}, \end{aligned}$$

hence, $(\mathcal{E}_n)_{n=1}^N$ is an orthonormal family in $L^2(M \times M, d^2\mu_Y)$. Since we have shown that $K \in L^2(M \times M, d^2\mu_Y)$, Bessel's inequality, combined with the reproducing property of K , leads to

$$\begin{aligned} \|K\|_{L^2(M \times M, d^2\mu_Y)}^2 &\geq \sum_{n=1}^N |(\mathcal{E}_n, K)_{L^2(M \times M, d^2\mu_Y)}|^2 \\ &= \sum_{n=1}^N \left| \int_M \int_M e_n(y') \overline{e_n(y)} K(y', y) d\mu_Y(y) d\mu_Y(y') \right|^2 \\ &= \sum_{n=1}^N \left| \int_M e_n(y') \overline{e_n(y')} d\mu_Y(y') \right|^2 = N. \end{aligned}$$

So, finally, (25) implies

$$N \leq \left(\sup_{y', y \in Y} |K(y', y)| \right)^2 \mu_Y(M)^2 < \infty,$$

and therefore each orthonormal set of \mathcal{H}_M is finite. \square

Now, choose M as a subset of \mathbf{R}^2 (resp. $\mathbf{R}^* \times \mathbf{R}$) and $\mathcal{H} = G_\psi(L^2(\mathbf{R})) \subset L^2(\mathbf{R}^2)$ (resp. $W_\psi(L^2(\mathbf{R})) \subset L^2(\mathbf{R}^* \times \mathbf{R}, \frac{dadb}{a^2})$). From section 2 we know that these two ranges are r.k.h.s with bounded kernels. Assuming, there exists at least one non-trivial function $F \in \mathcal{H}_M$, we will construct an infinite sequence of functions in \mathcal{H} being linearly independent and supported in a set of finite measure. Since this is a contradiction to lemma 3.1, \mathcal{H}_M must be zero space.

In the Gabor case, the construction is based on

LEMMA 3.2 (Shifting lemma) *Let M, M_0 be two subsets of \mathbf{R}^2 , $M_0 \subseteq M$, $\lambda^{(2)}(M_0) > 0$ and $\lambda^{(2)}(M) < \infty$. For $\omega_0 \in \mathbf{R}$ define*

$$M_0 - \omega_0 := \{(\omega, t) \in \mathbf{R}^2 : (\omega + \omega_0, t) \in M_0\}.$$

Then for each $\epsilon \in]0, \lambda^{(2)}(M_0)[$, there exists a real number $\omega^\epsilon \in \mathbf{R}$ such that

$$\lambda^{(2)}(M) < \lambda^{(2)}(M \cup (M_0 - \omega^\epsilon)) < \lambda^{(2)}(M) + \epsilon. \tag{26}$$

Proof: Consider the function

$$v : \mathbf{R} \rightarrow \mathbf{R}, \quad \omega \mapsto \lambda^{(2)}(M \cup (M_0 - \omega)).$$

This function is continuous, since

$$\begin{aligned} v(\omega) &= \lambda^{(2)}(M) + \lambda^{(2)}(M_0) - \lambda^{(2)}(M \cap (M_0 - \omega)) \\ &= \lambda^{(2)}(M) + \lambda^{(2)}(M_0) - \int_{-\infty}^{\infty} \int_{-\infty}^{\infty} \chi_M(\tilde{\omega}, t) \cdot \chi_{M_0 - \omega}(\tilde{\omega}, t) d\tilde{\omega} dt \\ &= \lambda^{(2)}(M) + \lambda^{(2)}(M_0) - \int_M \int \chi_{M_0}(\tilde{\omega} + \omega, t) d\tilde{\omega} dt \\ &= \text{const.} - \|\chi_{M_0}(\cdot + \omega, \cdot)\|_{L^1(M)}, \end{aligned}$$

and $\lim_{|h| \rightarrow 0} \|f(\cdot + h, \cdot) - f(\cdot, \cdot)\|_{L^1(M)} = 0$ for every $f \in L^1(M)$ (cf. [Okik71], 3.6). Hence, evaluating v at two suitably chosen points and using the mean value theorem leads to assertion (26). Such points shall be constructed in the following.

From $M_0 \subseteq M$, one gets $v(0) = \lambda^{(2)}(M)$, and therefore the lower bound in relation (26).

Since $\lambda^{(2)}(M) < \infty$, given $\delta > 0$, there exists a bounded measurable subset M^δ of M such that $\lambda^{(2)}(M \setminus M^\delta) < \delta$ (cf. [EvGa92]). Choose $K^\delta > 0$ such that M^δ lies completely in the ball of radius K^δ centered at the origin. Put $\omega^\delta := 3K^\delta$. Then $M^\delta \cap (M^\delta + \omega^\delta) = \emptyset$, and

$$\begin{aligned} \int_M \int \chi_{M_0}(\omega + \omega^\delta, t) d\omega dt &\leq \int_{M^\delta} \int \chi_{M_0}(\omega + \omega^\delta, t) d\omega dt + \delta \\ = \int_{M^\delta + \omega^\delta} \int \chi_{M_0}(\tilde{\omega}, t) d\tilde{\omega} dt + \delta &\leq \int_{\mathbf{R}^n \setminus M^\delta} \int \chi_M(\tilde{\omega}, t) d\tilde{\omega} dt + \delta \leq 2\delta, \end{aligned}$$

hence, as before,

$$v(\omega^\delta) \geq \lambda^{(2)}(M) + \lambda^{(2)}(M_0) - 2\delta.$$

Now the mean value theorem shows that v takes all values between $\lambda^{(2)}(M)$ and $\lambda^{(2)}(M) + \lambda^{(2)}(M_0) - 2\delta$ with δ arbitrarily small. This proves the assertion. \square

THEOREM 3.3 *For any window function ψ and any set $M \subset \mathbf{R}^2$ of finite Lebesgue measure, we have*

$$G_\psi(L^2(\mathbf{R})) \cap \{F \in L^2(\mathbf{R}^2) : F = \chi_M \cdot F\} = \{0\}. \quad (27)$$

Proof: Let us assume, there exists a non-trivial function F_0 satisfying

$$F_0 \in G_\psi(L^2(\mathbf{R})) \cap \{F \in L^2(\mathbf{R}^2) : F = \chi_M \cdot F\}. \quad (28)$$

Let $M_0 \subseteq M$ denote the support of F_0 , and choose $\epsilon \in]0, 2\lambda^{(2)}(M_0)[$ arbitrary. Using the notation of lemma 3.2 we define

$$\begin{aligned} M_1 &:= M, \\ M_2 &:= M_1 \cup (M_0 - \omega_1), \end{aligned}$$

where $\omega_1 \in \mathbf{R}$ is chosen such that

$$\lambda^{(2)}(M_1) < \lambda^{(2)}(M_2) < \lambda^{(2)}(M_1) + \epsilon \cdot 2^{-1},$$

and correspondingly for $k > 2$

$$M_k := M_{k-1} \cup (M_0 - \omega_1 - \dots - \omega_{k-1}),$$

where $\omega_{k-1} \in \mathbf{R}$ satisfies

$$\lambda^{(2)}(M_{k-1}) < \lambda^{(2)}(M_k) < \lambda^{(2)}(M_{k-1}) + \epsilon \cdot 2^{-k+1}.$$

The existence of suitable translations $\omega_{k-1} \in \mathbf{R}$ is guaranteed by lemma 3.2, since $M_0 \subseteq M_1 \subset M_2 \subset \dots \subset M_{k-2} \subset M_{k-1}$. Let $M^* := \bigcup_{k=1}^{\infty} M_k$. By construction

$$\lambda^{(2)}(M^*) \leq \lambda^{(2)}(M) + \epsilon \sum_{k=1}^{\infty} 2^{-k} = \lambda^{(2)}(M) + \epsilon.$$

Hence, $\lambda^{(2)}(M^*) < \infty$ for $\lambda^{(2)}(M) < \infty$. Let $F_1(\omega, t) := F_0(\omega, t)$, $F_k(\omega, t) := F_{k-1}(\omega + \omega_{k-1}, t)$ ($k \in \mathbf{N}, k > 1$). Using the invariance property (6) of the Gabor transform, we see that $F_k \in G_\psi(L^2(\mathbf{R}))$ ($k \in \mathbf{N}, k > 1$), and

$$\begin{aligned} \text{supp } F_k &= \text{supp } F_{k-1} - \omega_{k-1} \\ &= \text{supp } F_1 - \omega_1 - \dots - \omega_{k-1} \\ &= M_0 - \omega_1 - \dots - \omega_{k-1} \subseteq M_k \subset M^*. \end{aligned}$$

We now show the linear independence of the family $(F_k)_{k \geq 2}$. Let us assume, there exists a $k > 2$ such that

$$F_k = \sum_{\tilde{k}=2}^{k-1} a_{\tilde{k}} F_{\tilde{k}} \tag{29}$$

for some suitably chosen coefficients $a_2, a_3, \dots, a_{k-1} \in \mathbf{R}$. Then,

$$\text{supp } F_k \subseteq \bigcup_{\tilde{k}=2}^{k-1} \text{supp } F_{\tilde{k}},$$

and hence

$$\begin{aligned} &M_0 - \omega_1 - \dots - \omega_{k-1} \\ &\subseteq \{(M_0 - \omega_1) \cup (M_0 - \omega_1 - \omega_2) \cup \dots \cup (M_0 - \omega_1 - \omega_2 - \dots - \omega_{k-2})\} \\ &\subseteq M_{k-1}. \end{aligned}$$

On the other hand, $\lambda^{(2)}(M_k) > \lambda^{(2)}(M_{k-1})$ implies that $M_k = M_{k-1} \cup (M_0 - \omega_1 - \dots - \omega_{k-1})$ is a real superset of M_{k-1} . So, $M_0 - \omega_1 - \dots - \omega_{k-1}$ cannot be a subset of M_{k-1} . Therefore, a linear combination of type (29) is not possible, and hence $(F_k)_{k \geq 2}$ is an infinite set of linearly independent functions with $\text{supp } F_k \subset M^*$, where $\lambda^{(2)}(M^*) < \infty$. From section 2 we know that $G_\psi(L^2(\mathbf{R}))$ is a r.k.H.s. with pointwise bounded kernel. Hence, following lemma 3.1, each subspace of $G_\psi(L^2(\mathbf{R}))$ consisting of functions supported on a set of finite measure must be of finite dimension. This shows that assumption (28) was wrong. □

From theorem 3.3 we get immediately

COROLLARY 3.4 (The support of a GT has infinite measure)

Let ψ be a window function. Then, for $f \in L^2(\mathbf{R}) \setminus \{0\}$ arbitrary, the support of $G_\psi f$ is a set of infinite Lebesgue measure.

REMARK 3.5

Recalling the definition of the *cross-ambiguity function* of $f, g \in L^2(\mathbf{R})$

$$A(f, g)(\omega, t) := \frac{1}{\sqrt{2\pi}} \int_{-\infty}^{\infty} e^{i\omega\tilde{x}} f\left(\tilde{x} + \frac{t}{2}\right) \overline{g\left(\tilde{x} - \frac{t}{2}\right)} d\tilde{x}, \tag{30}$$

and rewriting (30) by

$$A(f, g)(\omega, t) = e^{-\frac{i\omega t}{2}} G_g f(-\omega, t), \tag{31}$$

we may conclude that $\text{supp } A(f, g)$ is of infinite measure, unless $f = 0$ or $g = 0$. This answers a question posed by Folland and Sitaram [FoSi97] which has been

considered independently by Jaming [Jami98] and Janssen [Jans98]. Their proofs are based on the Fourier uncertainty principle of Benedicks [Bene85]. Using the same principle, Janssen disproved the existence of an *half-space* in \mathbf{R}^2 containing a finitely measured part of $\text{supp } A(f, g)$ unless $f = 0$ or $g = 0$. Assuming f, g to be real-valued, this is a corollary to theorem 3.3, for $\lambda^{(2)}(\text{supp } G_\psi f(\omega, t)|_{\omega < 0}) < \infty$ implies $\lambda^{(2)}(\text{supp } \overline{G_\psi f(\omega, t)}|_{\omega < 0}) < \infty$, and therefore $\lambda^{(2)}(\text{supp } G_\psi f(\omega, t)|_{\omega > 0}) < \infty$, hence $\lambda^{(2)}(\text{supp } G_\psi f(\omega, t)) < \infty$, where $\{(\omega, t) \in \mathbf{R}^2 : \omega < 0\}$ is representative for any subspace of \mathbf{R}^2 (cf. [Jans98]). In case $f = g$, complex values are admissible, as well.

Looking more closely at the proof of theorem 3.3 we find as its main ingredients

- a r.k.H.s. in an L^2 -space with a pointwise bounded reproducing kernel,
- translation invariance in at least one fixed direction.

Consequently, results of this type hold in a much wider sense:

THEOREM 3.6 (Abstract version) *Let \mathcal{H} be a r.k.H.s. consisting of functions on \mathbf{R}^n which are square-integrable with respect to Lebesgue measure. Assume, the reproducing kernel K of \mathcal{H} is bounded. Let $U \neq \{0\}$ be a subspace of \mathbf{R}^n such that $F \in \mathcal{H}$, $u \in U$ imply $F(\cdot - u) \in \mathcal{H}$. Then, for each $F \in \mathcal{H}$, one has $\lambda^{(n)}(\text{supp } F) = \infty$.*

To obtain a corresponding result for the wavelet transform, we need an affine version of the shifting lemma 3.2. Using μ_{aff} instead of Lebesgue measure, we find analogously:

LEMMA 3.7 (Affine shifting lemma) *Let M, M_0 be two subsets of $\mathbf{R}^* \times \mathbf{R}$, $M_0 \subseteq M$, $\mu_{aff}(M_0) > 0$ and $\mu_{aff}(M) < \infty$. For $b_0 \in \mathbf{R}$ define*

$$M_0 - b_0 := \{(a, b) \in \mathbf{R}^* \times \mathbf{R} : (a, b + b_0) \in M_0\}.$$

Then, for each $\epsilon \in]0, \mu_{aff}(M_0)[$, there exists a number $b^\epsilon \in \mathbf{R}$ such that

$$\mu_{aff}(M) < \mu_{aff}(M \cup (M_0 - b^\epsilon)) < \mu_{aff}(M) + \epsilon. \quad (32)$$

Hence, using (14) we can conclude as before

THEOREM 3.8 *For any wavelet ψ and any set $M \subset \mathbf{R}^* \times \mathbf{R}$ of finite affine measure, we have*

$$W_\psi(L^2(\mathbf{R})) \cap \{F \in L^2(\mathbf{R}^* \times \mathbf{R}, d\mu_{aff}) : F = \chi_M \cdot F\} = \{0\}. \quad (33)$$

COROLLARY 3.9 (The support of a WT has infinite measure)

Let ψ be a wavelet. Then, for $f \in L^2(\mathbf{R}) \setminus \{0\}$ arbitrary, the support of $W_\psi f$ is a set of infinite affine measure.

REMARK 3.10 There is no such result for *discrete* Gabor resp. wavelet transforms related to *orthonormal bases*¹:

Let $(\psi_{jk})_{j,k \in \mathbf{Z}}$ be an orthonormal wavelet basis in $L^2(\mathbf{R})$ and $f = \psi = \psi_{00}$. Then

$$f = \sum_{j,k \in \mathbf{Z}} (f, \psi_{jk})_{L^2(\mathbf{R})} \psi_{jk} = \sum_{j,k \in \mathbf{Z}} \delta_{jk} \psi_{jk},$$

hence, there is just one non-vanishing wavelet coefficient.

This is a consequence of the fact that there is no translation invariance in the discrete setting.

4 APPROXIMATIVE CONCENTRATION OF GABOR AND WAVELET TRANSFORMS

From the foregoing section we know that the Gabor transform $G_\psi f$ of a function $f \in L^2(\mathbf{R}) \setminus \{0\}$ cannot possess a support of finite Lebesgue measure. In the following we will show that the portion of $G_\psi f$ lying outside some set M of finite Lebesgue measure cannot be arbitrarily small, either. For sufficiently *small* M , this can be seen immediately by estimating the Hilbert-Schmidt norm of a suitably defined operator. Taking into account some geometric properties of abstract Hilbert spaces, we find that restrictions of this kind hold for *arbitrary* sets of finite Lebesgue measure. More precise results going in that direction can be found by Daubechies [Daub88, Daub92], but only for *special* window functions ψ and *special* sets M .

The wavelet transform is treated in an analogous manner.

THEOREM 4.1 (Concentration of $G_\psi f$ in small sets) *Let ψ be a window function and $M \subset \mathbf{R}^2$ with $\lambda^{(2)}(M) < 1$. Then, for $f \in L^2(\mathbf{R})$ arbitrary,*

$$\|G_\psi f - \chi_M \cdot G_\psi f\|_{L^2(\mathbf{R}^2)} \geq \|\psi\|_{L^2(\mathbf{R})} (1 - \lambda^{(2)}(M)^{1/2}) \|f\|_{L^2(\mathbf{R})}. \quad (34)$$

Proof: Define $P_R : L^2(\mathbf{R}^2) \rightarrow L^2(\mathbf{R}^2)$ as the orthogonal projection from $L^2(\mathbf{R}^2)$ onto $G_\psi(L^2(\mathbf{R}))$, and $P_M : L^2(\mathbf{R}^2) \rightarrow L^2(\mathbf{R}^2)$ as the orthogonal projection from $L^2(\mathbf{R}^2)$ onto the subspace of functions supported in M . From corollary 2.5 we obtain

$$\begin{aligned} & \frac{1}{\|\psi\|_{L^2(\mathbf{R})}} \|G_\psi f - \chi_M \cdot G_\psi f\|_{L^2(\mathbf{R}^2)} \\ &= \frac{1}{\|\psi\|_{L^2(\mathbf{R})}} \|G_\psi f - P_M P_R(G_\psi f)\|_{L^2(\mathbf{R}^2)} \\ &\geq (1 - \|P_M P_R\|) \|f\|_{L^2(\mathbf{R})}, \end{aligned}$$

hence

$$\|G_\psi f - \chi_M \cdot G_\psi f\|_{L^2(\mathbf{R}^2)} \geq \|\psi\|_{L^2(\mathbf{R})} (1 - \|P_M P_R\|) \|f\|_{L^2(\mathbf{R})}. \quad (35)$$

¹For definitions see e.g. [Daub92].

Being the projection onto a r.k.H.s., P_R can be represented by [Sait88]

$$P_R : F \mapsto P_R F(\omega, t) = (F(\omega', t'), K_\psi(\omega', t'; \omega, t))_{L^2(\mathbf{R}^2)}$$

with K_ψ defined by (8). Hence, for $F \in L^2(\mathbf{R}^2)$ arbitrary, we have

$$P_M P_R F(\omega, t) = \int_{-\infty}^{\infty} \int_{-\infty}^{\infty} \chi_M(\omega, t) K_\psi(\omega', t'; \omega, t) F(\omega', t') d\omega' dt'$$

Therefore, the operator norm $\|P_M P_R\|$ can be estimated by the Hilbert-Schmidt norm $\|P_M P_R\|_{HS}$ (cf. [HaSu78]), using the fact that $\frac{1}{\|\psi\|_{L^2(\mathbf{R})}} G_\psi$ is an isometry:

$$\begin{aligned} & \|P_M P_R\|_{HS}^2 \\ &= \int_{-\infty}^{\infty} \int_{-\infty}^{\infty} \int_{-\infty}^{\infty} \int_{-\infty}^{\infty} |\chi_M(\omega, t) K_\psi(\omega', t'; \omega, t)|^2 d\omega' dt' d\omega dt \\ &= \int_{-\infty}^{\infty} \int_{-\infty}^{\infty} \int_{-\infty}^{\infty} \int_{-\infty}^{\infty} \left| \chi_M(\omega, t) \frac{1}{\|\psi\|_{L^2(\mathbf{R})}^2} (\psi_{\omega t}, \psi_{\omega' t'})_{L^2(\mathbf{R})} \right|^2 d\omega' dt' d\omega dt \\ &= \int_{-\infty}^{\infty} \int_{-\infty}^{\infty} \int_{-\infty}^{\infty} \int_{-\infty}^{\infty} \left| \chi_M(\omega, t) \frac{1}{\|\psi\|_{L^2(\mathbf{R})}^2} G_\psi \psi_{\omega t}(\omega', t') \right|^2 d\omega' dt' d\omega dt \\ &= \frac{1}{\|\psi\|_{L^2(\mathbf{R})}^2} \int_{-\infty}^{\infty} \int_{-\infty}^{\infty} \int_M \int_M \left| \frac{1}{\|\psi\|_{L^2(\mathbf{R})}} G_\psi \psi_{\omega t}(\omega', t') \right|^2 d\omega' dt' d\omega dt \\ &= \frac{1}{\|\psi\|_{L^2(\mathbf{R})}^2} \int_M \int_M \left(\int_{-\infty}^{\infty} |\psi_{\omega t}(x)|^2 dx \right) d\omega dt \\ &\leq \frac{1}{\|\psi\|_{L^2(\mathbf{R})}^2} \|\psi\|_{L^2(\mathbf{R})}^2 \lambda^{(2)}(M) = \lambda^{(2)}(M). \end{aligned}$$

Putting this into (35) proves the assertion. \square

REMARK 4.2 Notice that the lower bound for $\|G_\psi f - \chi_M \cdot G_\psi f\|_{L^2(\mathbf{R}^2)}$ in (34) is the bigger the smaller $\lambda^{(2)}(M)$ is. This is in accordance with the philosophy of uncertainty.

REMARK 4.3 Using mean value theorem and Cauchy-Schwarz's inequality, one gets immediately the related result

$$\begin{aligned} \|\chi_M \cdot G_\psi f\|_{L^2(\mathbf{R}^2)} &\leq \lambda^{(2)}(M)^{1/2} \|G_\psi f\|_{L^\infty(\mathbf{R})} \\ &\leq \|\psi\|_{L^2(\mathbf{R})} \lambda^{(2)}(M)^{1/2} \|f\|_{L^2(\mathbf{R})} \end{aligned}$$

(cf. [FoSi97]). The use of the projections P_R and P_M in the proof of theorem 4.1 leads to further conclusions, however:

REMARK 4.4 (Stable reconstruction from incomplete noisy data)

Let ψ be a window function, $M \subset \mathbf{R}^2$ with $\lambda^{(2)}(M) < 1$ and P_M the orthogonal projection from $L^2(\mathbf{R}^2)$ onto the subspace of functions supported on M . Then there exists a linear operator $R_{\psi,M}: L^2(\mathbf{R}^2) \rightarrow L^2(\mathbf{R}^2)$, as well as a constant $K_{\psi,M}^G > 0$ such that for all $F \in G_\psi(L^2(\mathbf{R}^2))$, for all $n \in L^2(\mathbf{R}^2)$ and

$$\tilde{F} := (\mathbf{1} - P_M)F + n \quad (36)$$

we have

$$\|F - R_{\psi,M}\tilde{F}\|_{L^2(\mathbf{R}^2)} \leq K_{\psi,M}^G \|n\|_{L^2(\mathbf{R}^2)}. \quad (37)$$

Interpretation:

The original signal F can be stably reconstructed from the measured signal \tilde{F} affected with noise n using exclusively data from the complement of M . Here, stability has to be understood in the sense that the reconstruction error is proportional to the $L^2(\mathbf{R}^2)$ -norm of the noise. If there is no noise at all ($n = 0$), perfect reconstruction of F from $\tilde{F} := (\mathbf{1} - P_M)F$ is possible. An upper bound for the constant $K_{\psi,M}^G$ in (37) is given by

$$K_{\psi,M}^G \leq \frac{1}{1 - \lambda^{(2)}(M)^{1/2}}. \quad (38)$$

The connection between this result and Gerchberg-Papoulis' algorithm [ByWe85, DoSt89] for the reconstruction of incomplete Fourier data will be treated elsewhere.

Proof of (37):

Choose $R_{\psi,M} := (\mathbf{1} - P_M P_R)^{-1}$ with P_R defined as in the proof of theorem 4.1. From there we know that $\|P_M P_R\|^2 \leq \lambda^{(2)}(M) < 1$, showing that the Neumann series $\sum_{n=0}^{\infty} (P_M P_R)^n$ is convergent. Hence, $(\mathbf{1} - P_M P_R)^{-1}$ is well-defined. Now,

$$\begin{aligned} \|F - R_{\psi,M}\tilde{F}\|_{L^2(\mathbf{R}^2)} &= \|F - R_{\psi,M}(\mathbf{1} - P_M)F - R_{\psi,M}n\|_{L^2(\mathbf{R}^2)} \\ &= \|F - R_{\psi,M}(\mathbf{1} - P_M P_R)F - R_{\psi,M}n\|_{L^2(\mathbf{R}^2)} \\ &= \|F - F - R_{\psi,M}n\|_{L^2(\mathbf{R}^2)} \leq \|R_{\psi,M}\| \cdot \|n\|_{L^2(\mathbf{R}^2)}, \end{aligned}$$

where

$$\begin{aligned} \|R_{\psi,M}\| &= \|\mathbf{1} - P_M P_R\|^{-1} \\ &\leq (1 - \|P_M P_R\|)^{-1} \\ &\leq (1 - \lambda^{(2)}(M)^{1/2})^{-1}. \quad \square \end{aligned}$$

Correspondingly, we obtain for the wavelet transform:

THEOREM 4.5 (Concentration of $W_\psi f$ in small sets) *Let ψ be a mother wavelet and $M \subset \mathbf{R}^* \times \mathbf{R}$ with*

$$\frac{\|\psi\|_{L^2(\mathbf{R})}}{\sqrt{c_\psi}} \mu_{aff}(M)^{1/2} < 1.$$

Then for $f \in L^2(\mathbf{R})$ arbitrary,

$$\begin{aligned} & \|W_\psi f - \chi_M \cdot W_\psi f\|_{L^2(\mathbf{R}^* \times \mathbf{R}, \frac{da db}{a^2})} \\ & \geq \sqrt{c_\psi} \left(1 - \frac{\|\psi\|_{L^2(\mathbf{R})}}{\sqrt{c_\psi}} \mu_{aff}(M)^{1/2} \right) \|f\|_{L^2(\mathbf{R})}. \end{aligned} \quad (39)$$

REMARK 4.6 Assuming $\|\psi\|_{L^2(\mathbf{R})} = 1$ we find (34) independent of ψ , while $\sqrt{c_\psi}$ cannot be eliminated from (39).

Analogously, the following abstract version of theorems 4.1, 4.5 can be proved:

THEOREM 4.7 (Abstract concentration theorem for small sets) *Let G be a locally compact group with left Haar measure μ_L , \mathcal{H} a complex Hilbert space, U a square integrable, irreducible, unitary representation of G on \mathcal{H} and C_U the operator from theorem 21. For $\psi \in \mathcal{H}$ U -admissible we define an operator*

$$T_\psi : \mathcal{H} \rightarrow L^2(G, \mu_L), \quad f \mapsto T_\psi f,$$

setting

$$T_\psi f(g) := (f, U(g)\psi)_\mathcal{H} \quad (g \in G).$$

Then, for $M \subset G$ with $\frac{\|\psi\|_\mathcal{H}}{\|C_U \psi\|_\mathcal{H}} \mu_L(M)^{1/2} < 1$ and $f \in \mathcal{H}$ arbitrary,

$$\|T_\psi f - \chi_M \cdot T_\psi f\|_{L^2(G, d\mu_L)} \geq \|C_U \psi\|_\mathcal{H} \left(1 - \frac{\|\psi\|_\mathcal{H}}{\|C_U \psi\|_\mathcal{H}} \mu_L(M)^{1/2} \right) \|f\|_\mathcal{H}. \quad (40)$$

QUESTION 4.8 Are there restrictions similar to (34) (resp. (39)) for 'bigger' sets, as well? More precisely: given an arbitrary set M of finite Lebesgue (resp. affine) measure – do there exist any constants $C_{\psi, M}^G$ (resp. $C_{\psi, M}^W$) > 0 such that for $f \in L^2(\mathbf{R})$ arbitrary

$$\|G_\psi f - \chi_M \cdot G_\psi f\|_{L^2(\mathbf{R}^2)} \geq C_{\psi, M}^G \|f\|_{L^2(\mathbf{R})} \quad (41)$$

$$\text{(resp. } \|W_\psi f - \chi_M \cdot W_\psi f\|_{L^2(\mathbf{R}^2)} \geq C_{\psi, M}^W \|f\|_{L^2(\mathbf{R})} \text{)} ? \quad (42)$$

Using an abstract result of Havin and Jöricke [HaJo94] we will see that the answer to this question is 'yes'. We will not be able to give an estimate for $C_{\psi, M}^G$, $C_{\psi, M}^W$ by the measure of M , however.

LEMMA 4.9 (Havin-Jörlicke) *Let $\mathcal{H}_1, \mathcal{H}_2$ be two closed subspaces of a Hilbert space \mathcal{H} satisfying*

$$\mathcal{H}_1 \cap \mathcal{H}_2 = \{0\}. \tag{43}$$

Let $P_{\mathcal{H}_1}, P_{\mathcal{H}_2}$ denote the corresponding orthogonal projections, and assume the product $P_{\mathcal{H}_1}P_{\mathcal{H}_2}$ to be a compact operator. Then, there exists a constant $C > 0$ such that for all $f \in \mathcal{H}$

$$\|P_{\mathcal{H}_1^\perp}f\|_{\mathcal{H}} + \|P_{\mathcal{H}_2^\perp}f\|_{\mathcal{H}} \geq C\|f\|_{\mathcal{H}}. \tag{44}$$

Proof: Cf. [HaJo94] I.3 §1.2 □

REMARK 4.10 Subspaces $\mathcal{H}_1, \mathcal{H}_2$ satisfying (43) are said to form an *annihilating pair* or, shorter, an *a-pair*. Subspaces satisfying the harder condition (44) are said to form a *strongly annihilating pair* or, shorter, *strong a-pair*, cf. [HaJo94]. From the same reference we know that condition (44) is equivalent to

$$\alpha(\mathcal{H}_1, \mathcal{H}_2) > 0,$$

where $\alpha(\mathcal{H}_1, \mathcal{H}_2)$ denotes the *angle*² between \mathcal{H}_1 and \mathcal{H}_2 , defined as the real number in $[0, \frac{\pi}{2}]$ satisfying

$$\cos(\alpha(\mathcal{H}_1, \mathcal{H}_2)) = \sup\{|(f, g)_{\mathcal{H}}| : f \in \mathcal{H}_1, \|f\|_{\mathcal{H}} \leq 1, g \in \mathcal{H}_2, \|g\|_{\mathcal{H}} \leq 1\}.$$

The angle $\alpha(\mathcal{H}_1, \mathcal{H}_2)$ is related to the projections $P_{\mathcal{H}_1}, P_{\mathcal{H}_2}$ according to:

$$\cos(\alpha(\mathcal{H}_1, \mathcal{H}_2)) = \|P_{\mathcal{H}_1}P_{\mathcal{H}_2}\|, \tag{45}$$

cf. [HaJo94], I.3 §1.1. The optimal constant C in (44) is as a function of $\alpha(\mathcal{H}_1, \mathcal{H}_2)$.

THEOREM 4.11 (Concentration of $G_\psi f$ in arbitrary sets of finite measure)
Let ψ be a window function and $M \subset \mathbf{R}^2$ with $\lambda^{(2)}(M) < \infty$. Then there exists a constant $C_{\psi, M}^G > 0$ such that for $f \in L^2(\mathbf{R})$ arbitrary (41) holds.

Proof: Defining P_M, P_R as in the proof of theorem 4.1 and $\mathcal{H}_1, \mathcal{H}_2$ by

$$\mathcal{H}_1 := P_M(L^2(\mathbf{R}^2)), \tag{46}$$

$$\mathcal{H}_2 := P_R(L^2(\mathbf{R}^2)), \tag{47}$$

we conclude from theorem 3.3 that \mathcal{H}_1 and \mathcal{H}_2 form an a-pair. The proof of theorem 4.1 implies that for $M \subseteq \mathbf{R}^2$ arbitrary with $\lambda^{(2)}(M) < \infty$

$$\|P_M P_R\|_{HS} \leq (\lambda^{(2)}(M))^{1/2} < \infty.$$

²Cf. [Deut95] for more information on that subject.

Hence, $P_M P_R$ is a Hilbert-Schmidt operator and therefore compact, which means that $\mathcal{H}_1, \mathcal{H}_2$ form a strong a-pair. Now lemma 4.9 implies the existence of a constant $C > 0$ such that (44) holds for $P_{\mathcal{H}_1} := P_M$ and $P_{\mathcal{H}_2} := P_R$. Since $P_{\mathcal{H}_1^\perp}(G_\psi f) = (\mathbf{1} - P_R)G_\psi f = 0$, this leads to (41). \square

Again, theorem 4.11 can be generalized to a wider class of transforms. Especially, we have the following wavelet counterpart:

THEOREM 4.12 (Concentration of $W_\psi f$ in arbitrary sets of finite measure)
Let ψ be a mother wavelet and $M \subset \mathbf{R}^ \times \mathbf{R}$ with $\mu_{aff}(M) < \infty$. Then there exists a constant $C_{\psi, M}^W > 0$ such that for $f \in L^2(\mathbf{R})$ arbitrary (42) holds.*

The abstract version of theorem 4.11 is

THEOREM 4.13 (Abstract concentration theorem for arbitrary sets) *Allowing $M \subset G$ with $\mu_L(M) < \infty$ arbitrary in the situation of theorem 4.7, there exists a constant $C_{\psi, M}^T > 0$ such that for all $f \in \mathcal{H}$*

$$\|T_\psi f - \chi_M \cdot T_\psi f\|_{L^2(G, d\mu_L)} \geq C_{\psi, M}^T \|f\|_{\mathcal{H}}. \quad (48)$$

5 UNCERTAINTY PRINCIPLES OF HEISENBERG TYPE

Up to now, we analyzed the concentration of $G_\psi f$ (resp. $W_\psi f$) as a function on two-dimensional phase-space. A different class of uncertainty principles results from comparing the localization of f (resp. \hat{f}) with the localization of its Gabor or wavelet transform regarded as function of *one* variable. Some results of that type, originating from an idea of Singer in the wavelet case [Sing92], will be presented in this final section.

THEOREM 5.1 (UP of Heisenberg type for GT in ω) *Let ψ be a window function. Then, for $f \in L^2(\mathbf{R})$ arbitrary, the following inequality holds*

$$\begin{aligned} \left(\int_{-\infty}^{\infty} \omega^2 |G_\psi f(\omega, t)|^2 d\omega dt \right)^{1/2} & \left(\int_{-\infty}^{\infty} x^2 |f(x)|^2 dx \right)^{1/2} \\ & \geq \frac{1}{2} \|\psi\|_{L^2(\mathbf{R})} \|f\|_{L^2(\mathbf{R})}^2. \end{aligned} \quad (49)$$

Proof: Let us assume the non-trivial case that both integrals on the left hand side of (49) are finite. By translation invariance of Lebesgue integral we get

$$\begin{aligned} \|\psi\|_{L^2(\mathbf{R})}^2 \int_{-\infty}^{\infty} x^2 |f(x)|^2 dx &= \int_{-\infty}^{\infty} \int_{-\infty}^{\infty} x^2 |\psi(x-t)|^2 |f(x)|^2 dx dt \\ &= \int_{-\infty}^{\infty} \int_{-\infty}^{\infty} x^2 |\mathcal{F}_\omega^{-1}(G_\psi f(\omega, t))(x)|^2 dx dt, \end{aligned}$$

where \mathcal{F}_ω denotes Fourier transform with respect to the variable ω . Fixing $t \in \mathbf{R}$ arbitrary, Heisenberg's inequality implies

$$\begin{aligned} \left(\int_{-\infty}^{\infty} \omega^2 |G_\psi f(\omega, t)|^2 d\omega \right)^{1/2} & \left(\int_{-\infty}^{\infty} x^2 |\mathcal{F}_\omega^{-1}(G_\psi f(\omega, t))(x)|^2 dx \right)^{1/2} \\ & \geq \frac{1}{2} \int_{-\infty}^{\infty} |G_\psi f(\omega, t)|^2 d\omega. \end{aligned}$$

Integrating over t and using the inequality of Cauchy-Schwarz, as well as the isometry property of $\frac{1}{\|\psi\|_{L^2(\mathbf{R})}} G_\psi$, results in

$$\begin{aligned} & \left(\int_{-\infty}^{\infty} \int_{-\infty}^{\infty} \omega^2 |G_\psi f(\omega, t)|^2 d\omega dt \right)^{1/2} \|\psi\|_{L^2(\mathbf{R})} \left(\int_{-\infty}^{\infty} x^2 |f(x)|^2 dx \right)^{1/2} \\ & = \left(\int_{-\infty}^{\infty} \int_{-\infty}^{\infty} \omega^2 |G_\psi f(\omega, t)|^2 d\omega dt \right)^{1/2} \left(\int_{-\infty}^{\infty} \int_{-\infty}^{\infty} x^2 |\mathcal{F}_\omega^{-1}(G_\psi f(\omega, t))(x)|^2 dx dt \right)^{1/2} \\ & \geq \int_{-\infty}^{\infty} \left(\int_{-\infty}^{\infty} \omega^2 |G_\psi f(\omega, t)|^2 d\omega \right)^{1/2} \left(\int_{-\infty}^{\infty} x^2 |\mathcal{F}_\omega^{-1}(G_\psi f(\omega, t))(x)|^2 dx \right)^{1/2} dt \\ & \geq \frac{1}{2} \int_{-\infty}^{\infty} \int_{-\infty}^{\infty} |G_\psi f(\omega, t)|^2 d\omega dt = \frac{1}{2} \|\psi\|_{L^2(\mathbf{R})}^2 \|f\|_{L^2(\mathbf{R})}^2. \end{aligned}$$

Dividing by $\|\psi\|_{L^2(\mathbf{R})}$ leads to (49). □

REMARK 5.2 Note that the localization of ψ has no influence on (49).

THEOREM 5.3 (UP of Heisenberg type for GT in t) *Let ψ be a window function. Then, for $f \in L^2(\mathbf{R})$ arbitrary, the following inequality holds*

$$\begin{aligned} & \left(\int_{-\infty}^{\infty} t^2 |G_\psi f(\omega, t)|^2 d\omega dt \right)^{1/2} \left(\int_{-\infty}^{\infty} \xi^2 |\hat{f}(\xi)|^2 d\xi \right)^{1/2} \\ & \geq \frac{1}{2} \|\psi\|_{L^2(\mathbf{R})} \|f\|_{L^2(\mathbf{R})}. \end{aligned} \tag{50}$$

Proof: Similiar to the proof of theorem 5.1 using the Fourier representation of $G_\psi f$. □

COROLLARY 5.4 (Phase space uncertainty of GT) *For ψ a window function, and $f \in L^2(\mathbf{R})$ arbitrary, we have*

$$\left(\int_{-\infty}^{\infty} \int_{-\infty}^{\infty} t^2 |G_{\psi} f(\omega, t)|^2 d\omega dt \right)^{1/2} \left(\int_{-\infty}^{\infty} \int_{-\infty}^{\infty} \omega^2 |G_{\psi} f(\omega, t)|^2 d\omega dt \right)^{1/2} \cdot \left(\int_{-\infty}^{\infty} x^2 |f(x)|^2 dx \right)^{1/2} \left(\int_{-\infty}^{\infty} \xi^2 |\hat{f}(\xi)|^2 d\xi \right)^{1/2} \geq \frac{1}{4} \|\psi\|_{L^2(\mathbf{R})} \|f\|_{L^2(\mathbf{R})}^4.$$

REMARK 5.5 Above corollary may be interpreted as follows: The better the phase space localization of the pair (f, \hat{f}) , the worse is the phase space localization of the Gabor transform $G_{\psi} f(\omega, t)$.

REMARK 5.6 The symmetry between f and ψ in the definition of Gabor transform leads to similar relations between $G_{\psi} f$ and ψ (resp. $\hat{\psi}$):

$$\left(\int_{-\infty}^{\infty} \omega^2 |G_{\psi} f(\omega, t)|^2 d\omega dt \right)^{1/2} \left(\int_{-\infty}^{\infty} x^2 |\psi(x)|^2 dx \right)^{1/2} \geq \frac{1}{2} \|f\|_{L^2(\mathbf{R})} \|\psi\|_{L^2(\mathbf{R})}^2,$$

$$\left(\int_{-\infty}^{\infty} t^2 |G_{\psi} f(\omega, t)|^2 d\omega dt \right)^{1/2} \left(\int_{-\infty}^{\infty} \xi^2 |\hat{\psi}(\xi)|^2 d\xi \right)^{1/2} \geq \frac{1}{2} \|f\|_{L^2(\mathbf{R})} \|\psi\|_{L^2(\mathbf{R})}^2.$$

THEOREM 5.7 (UP of Heisenberg type for the WT in b) *Let ψ be a mother wavelet. Then, for $f \in L^2(\mathbf{R})$ arbitrary,*

$$\left(\int_{-\infty}^{\infty} \int_{-\infty}^{\infty} b^2 |W_{\psi} f(a, b)|^2 \frac{da db}{a^2} \right)^{1/2} \left(\int_{-\infty}^{\infty} \xi^2 |\hat{f}(\xi)|^2 d\xi \right)^{1/2} \geq \frac{\sqrt{c_{\psi}}}{2} \|f\|_{L^2(\mathbf{R})}^2. \quad (51)$$

Proof: Similar to the proof of theorem 5.1. Assuming the existence of both integrals on the left hand side of (51), we get from the admissibility condition (10) for ψ

$$2\pi \int_{-\infty}^{\infty} \int_{-\infty}^{\infty} \xi^2 |\hat{\psi}(a\xi)|^2 |\hat{f}(\xi)|^2 \frac{da}{|a|} d\xi = c_{\psi} \int_{-\infty}^{\infty} \xi^2 |\hat{f}(\xi)|^2 d\xi.$$

Using the Fourier representation of the wavelet transform (13), this implies

$$\int_{-\infty}^{\infty} \xi^2 |\mathcal{F}_b(W_{\psi} f(a, b))(\xi)|^2 \frac{da}{a^2} d\xi = c_{\psi} \int_{-\infty}^{\infty} \xi^2 |\hat{f}(\xi)|^2 d\xi. \quad (52)$$

On the other hand, Heisenberg's inequality leads to

$$\begin{aligned} & \left(\int_{-\infty}^{\infty} b |W_{\psi} f(a, b)|^2 db \right)^{1/2} \left(\int_{-\infty}^{\infty} \xi^2 |\mathcal{F}_b(W_{\psi} f(a, b))(\xi)|^2 d\xi \right)^{1/2} \\ & \geq \frac{1}{2} \int_{-\infty}^{\infty} |W_{\psi} f(a, b)|^2 db \end{aligned}$$

for all $a \in \mathbf{R}^*$. Integrating with respect to $\frac{da}{a^2}$ gives

$$\begin{aligned} & \int_{-\infty}^{\infty} \left[\left(\int_{-\infty}^{\infty} b^2 |W_{\psi} f(a, b)|^2 db \right)^{1/2} \left(\int_{-\infty}^{\infty} \xi^2 |\mathcal{F}_b(W_{\psi} f(a, b))(\xi)|^2 d\xi \right)^{1/2} \right] \frac{da}{a^2} \\ & \geq \frac{1}{2} \int_{-\infty}^{\infty} \int_{-\infty}^{\infty} |W_{\psi} f(a, b)|^2 \frac{da}{a^2} db. \end{aligned}$$

The left hand side of this inequality may be estimated from above using Cauchy-Schwarz's inequality. The right hand side can be rewritten by the isometry of $\frac{1}{\sqrt{c_{\psi}}} W_{\psi}$. From (52) we therefore get

$$\begin{aligned} & \left(\int_{-\infty}^{\infty} \int_{-\infty}^{\infty} b^2 |W_{\psi} f(a, b)|^2 db \frac{da}{a^2} \right)^{1/2} \left(\int_{-\infty}^{\infty} \xi^2 |\mathcal{F}_b(W_{\psi} f(a, b))(\xi)|^2 d\xi \frac{da}{a^2} \right)^{1/2} \\ & = \left(\int_{-\infty}^{\infty} \int_{-\infty}^{\infty} b^2 |W_{\psi} f(a, b)|^2 db \frac{da}{a^2} \right)^{1/2} \sqrt{c_{\psi}} \left(\int_{-\infty}^{\infty} \xi^2 |f(\xi)|^2 d\xi \right)^{1/2} \\ & \geq \frac{1}{2} c_{\psi} \|f\|_{L^2(\mathbf{R})}^2. \quad \square \end{aligned}$$

REMARK 5.8 There is not so much symmetry between the parameters a and b of the wavelet transform as there is symmetry between ω and t in the Gabor case. An uncertainty relation between $W_{\psi} f$ as a function of a and f as a function of x will be derived in the following using a slightly *modified definition of wavelet transform*. Making use of Kaiser's observation [Kais95] that "frequency filters" $\hat{f}(\xi) \mapsto w_f(\xi)\hat{f}(\xi)$ often correspond to "scale filters" $W_{\psi} f(a, b) \mapsto w_S(a)W_{\psi} f(a, b)$. Here, w_F, w_S denote some suitable filter functions.

THEOREM 5.9 (UP of Heisenberg type for WT in a) *Let ψ be a mother wavelet, $\hat{\psi}(\xi) = 0$ for $\xi < 0$ and $f \in L^2(\mathbf{R}) \setminus \{0\}$ arbitrary. Consider*

the following modified definition of wavelet transform:

$$\tilde{W}_\psi : f \mapsto \tilde{W}_\psi f(a, b) := \int_{-\infty}^{\infty} f(x) \overline{\psi(ax - b)} dx \quad ((a, b) \in \mathbf{R}^+ \times \mathbf{R}). \quad (53)$$

Then

$$\int_0^{\infty} \int_{-\infty}^{\infty} a^2 |\tilde{W}_\psi f(a, b)|^2 da db \cdot \int_{-\infty}^{\infty} x^2 |f(x)|^2 dx \geq \pi (\mathcal{M}(|\hat{\psi}|^2))(2) \|f\|_{L^2(\mathbf{R})}^2. \quad (54)$$

Here, $\mathcal{M} : f \mapsto (\mathcal{M}f)(\sigma) := \int_0^{\infty} f(x) x^{-\sigma} \frac{dx}{x}$ denotes classical Mellin transform.

We have equality in (54), if there exist some constants $C \in \mathbf{C}$ and $k > 0$ such that $f(x) = C e^{-k \frac{x^2}{2}}$.

Proof: In the following we assume that $\int_0^{\infty} \int_{-\infty}^{\infty} a^2 |\tilde{W}_\psi f(a, b)|^2 da db < \infty$ and $\int_{-\infty}^{\infty} x^2 |f(x)|^2 dx < \infty$. Otherwise, (54) is trivially satisfied. The Fourier representation of \tilde{W}_ψ is given by

$$\tilde{W}_\psi f(a, b) = \sqrt{2\pi} \mathcal{F}^{-1}(\hat{f}(a\xi) \overline{\hat{\psi}(\xi)})(b),$$

what can be seen by replacing ψ by $\mathcal{F}^{-1}(\hat{\psi})$. Using Plancherel's identity, we get

$$\begin{aligned} \int_{-\infty}^{\infty} |\tilde{W}_\psi f(a, b)|^2 db &= 2\pi \int_{-\infty}^{\infty} |\hat{f}(a\xi)|^2 |\hat{\psi}(\xi)|^2 d\xi \\ &= 2\pi \int_{-\infty}^{\infty} |\hat{f}(u)|^2 \left| \hat{\psi}\left(\frac{u}{a}\right) \right|^2 \frac{du}{a}. \end{aligned}$$

Integrating by $a^2 da$ leads to

$$\begin{aligned} \int_0^{\infty} \int_{-\infty}^{\infty} a^2 |\tilde{W}_\psi f(a, b)|^2 da db &= \int_0^{\infty} a^2 2\pi \left(\int_{-\infty}^{\infty} |\hat{f}(u)|^2 \left| \hat{\psi}\left(\frac{u}{a}\right) \right|^2 \frac{du}{a} \right) da \\ &= \int_{-\infty}^{\infty} |\hat{f}(u)|^2 \left(2\pi \int_0^{\infty} a \left| \hat{\psi}\left(\frac{u}{a}\right) \right|^2 da \right) du \\ &= \int_0^{\infty} K(u) |\hat{f}(u)|^2 du \end{aligned}$$

with

$$K(u) := 2\pi \int_{-\infty}^{\infty} \left| \hat{\psi} \left(\frac{u}{a} \right) \right|^2 \frac{du}{a}. \quad (55)$$

(This is the previously mentioned correspondence between "scale" and "frequency filters".) Introducing Mellin transform, we see that $K(u)$ is just a function of u^2 :

$$\begin{aligned} K(u) &= 2\pi \int_0^{\infty} \frac{u}{v} |\hat{\psi}(v)|^2 u \frac{dv}{v^2} \\ &= 2\pi u^2 \int_0^{\infty} |\hat{\psi}(v)|^2 v^{-2} \frac{dv}{v} \\ &= 2\pi u^2 \mathcal{M}(|\hat{\psi}|^2)(2). \end{aligned}$$

Now, the remainder follows from Heisenberg's uncertainty principle. \square

REMARK 5.10 Estimates for the variance of $W_{\psi} f(a, b)$ in both a and b were proved by Flandrin [Flan98].

ACKNOWLEDGMENTS

The author thanks her thesis adviser Prof. D. Kölzow, Friedrich-Alexander-Universität Erlangen-Nürnberg, for the statement of the problem and for stimulating discussions.

REFERENCES

- [AmBe77] W.O. Amrein, A.M. Berthier, *On support properties of L^p -functions and their Fourier transforms*, J. Funct. Anal. 24 (1977) 258-267.
- [Bali81] R. Balian, *Un principe d'incertitude fort en théorie du signal ou en mécanique quantique*, C.R. Acad. Sci. Paris 292 (1981) Ser. II, 1357-136.
- [Batt89] G. Battle, *Phase Space Localization Theorem for Ondelettes*, J. Math. Phys. 30 (1989) 2195-2196.
- [Batt97] G. Battle, *Heisenberg Inequalities for Wavelet States*, Appl. Comp. Harm. An. 47 (1997) 119-146.
- [Bene85] M. Benedicks, *On Fourier transforms of functions supported on finite Lebesgue measure*, J. Math. Anal. Appl. 106 (1985) 180-183.

- [BeJa76] A.M. Berthier, J.M. Jauch, *A theorem on the support of functions in $L^2(\mathbf{R})$ and of their Fourier transforms*, Lett. Math. Phys. 1 (1976) 93-97.
- [ByWe85] C.L. Byrne, D.M. Wells, *Optimality of Certain Iterative and Non-iterative Data Extrapolation Procedures*, J. Math. Anal. Appl. 111 (1985) 26-34.
- [Chan89] K. Chandrasekharan, *Classical Fourier Transforms*, Springer-Verlag, Berlin, 1989.
- [Chui92] C.K. Chui, *An introduction to wavelets*, Academic Press, Boston, 1992.
- [CoPr84] M. Cowling, J.F. Price, *Bandwidth versus Time Concentration: the Heisenberg-Pauli-Weyl Inequality*, SIAM J. Math. Anal. 15 (1984) 151-165.
- [DaMa95] S. Dahlke, P. Maaß, *The Affine Uncertainty Principle in One and Two Dimensions*, Computers Math. Appl. 30 (1995) 293ff.
- [Daub88] I. Daubechies, *Time-Frequency Localization Operators: A Geometric Phase Space Approach*, IEEE Trans. Inf. Th. 34 (1988) 605-612.
- [Daub90] I. Daubechies, *The Wavelet Transform, Time-Frequency Localization and Signal Analysis*, IEEE Trans. Inf. Th. 36 (1990) 961-1005.
- [Daub92] I. Daubechies, *Ten Lectures on Wavelets*, SIAM, Philadelphia, 1992.
- [Deut95] F. Deutsch, *The angle between subspaces of a Hilbert space*, In: P. Singh (Ed.), *Approximation Theory, Wavelets and Applications*, Kluwer Academic Publishers, 1995, 107-130.
- [DoSt89] D.L. Donoho, P.B. Stark, *Uncertainty Principles and Signal Recovery*, SIAM J. Appl. Math. 49 (1989) 906-931.
- [EvGa92] L.C. Evans, R.F. Gariepy, *Measure Theory and Fine Properties of Functions*, CRC Press, Boca Raton, 1992.
- [Flan98] P. Flandrin, *Separability, positivity, and minimum uncertainty in time-frequency energy distributions*. J. Math. Phys. 39 (1998) 4016-4040.
- [FoSi97] G.B. Folland, A. Sitaram, *The Uncertainty Principle: A Mathematical Survey*, J. Fourier Anal. and Appl. 3 (1997) 207-238.
- [GrMo85] A. Grossmann, J. Morlet, T. Paul, *Transforms associated to square integrable group representations I. General results*, J. Math. Phys. 26 (1985) 2473-2479.

- [HaSu78] P.R. Halmos, V.S. Sunder, *Bounded Integral Operators on L^2 Spaces*, Springer, Berlin 1978.
- [Hard33] G.H. Hardy, *A Theorem Concerning Fourier Transforms*, J. London Math. 8 (1933) 227-231.
- [HaJo94] V. Havin, B. Jöricke, *The uncertainty principle in harmonic analysis*, Springer, Berlin 1994.
- [HeWa89] C. Heil, D.F. Walnut, *Continuous and discrete wavelet transforms*, SIAM Rev. 31 (1989) 628-666
- [Heis27] W. Heisenberg, *Über den anschaulichen Inhalt der quantentheoretischen Kinematik und Mechanik*, Z. Physik 43 (1927) 172-198.
- [Jami98] P. Jaming, *Principe d'incertitude qualitatif et reconstruction de phase pour la transformée de Wigner*, Preprint, Univ. d'Orléans, 1998.
- [Jans98] A.J.E.M. Jansen, *Proof of a conjecture on the supports of Wigner distributions*, J. Fourier Anal. and Appl. 4 (1998) 723-726.
- [Kais95] G. Kaiser, *Wavelet Filtering with the Mellin Transform*, Preprint, University of Massachusetts-Lowell, Department of Mathematical Sciences, December 1995, 8 pages.
- [Koel94] D. Kölzow, *Wavelets – A Tutorial and a Bibliography*, Rend. Inst. Mat. Univ. Trieste XXVI (1994).
- [LaWi80] H.J. Landau, H. Widom, *Eigenvalue Distribution of Time and Frequency Limiting*, J. Math. An. Appl. 77 (1980) 469-481.
- [Lena72] A. Lenard, *The Numerical Range of a Pair of Projections*, J. Funct. Anal. 10 (1972) 410-423.
- [Low85] F. Low, *Complete sets of wave packets*, in: A passion for physics – essays in honor of Geoffrey Chew, World Scientific, Singapore, 1985, p. 17-22.
- [Mill91] W. Miller, Jr., *Topics in Harmonic Analysis with Applications to Radar and Sonar*, In: R.E. Blahut, W. Miller, C.H. Wilcox (Eds.), Radar and Sonar, Part I, Springer, New York, 1991
- [Okik71] G.O. Okikiolu, *Aspects of the Theory of Bounded Integral Operators in L^p -Spaces*, Academic Press, London/New York, 1971.
- [Sait88] S. Saitoh, *Theory of reproducing kernels and its applications*, Longman Scientific & Technical, Harlow, 1988.
- [Sing92] P. Singer, *Unpublished note*.

- [Slep65] D. Slepian, *Some asymptotic expansions for prolate spheroidal wave functions*, J. Math. Phys. 44 (1965) 99-140.
- [Slep83] D. Slepian, *Some comments on Fourier analysis, uncertainty and modelling*, SIAM Review 25 (1983) 379-393.
- [Wilc97] E. Wilczok, *Zur Funktionalanalysis der Wavelet- und der Gabor-transformation*, PhD Thesis, Universität Erlangen Nürnberg, 1997.

Elke Wilczok
CGK
Computer Gesellschaft Konstanz
Max-Stromeyer-Str. 116
78467 Konstanz
elke.wilczok@cgk.siemens.de

TRANSITIONS FROM RELATIVE EQUILIBRIA TO RELATIVE PERIODIC ORBITS

CLAUDIA WULFF

Received: June 1, 1998

Revised: February 8, 2000

Communicated by Bernold Fiedler

ABSTRACT. We consider G -equivariant semilinear parabolic equations where G is a finite-dimensional possibly non-compact symmetry group. We treat periodic forcing of relative equilibria and resonant periodic forcing of relative periodic orbits as well as Hopf bifurcation from relative equilibria to relative periodic orbits using Lyapunov-Schmidt reduction. Our main interest are drift phenomena caused by resonance. In comparison to a center manifold approach Lyapunov-Schmidt reduction is technically easier. We discuss impacts of our results on spiral wave dynamics.

2000 Mathematics Subject Classification: 35B32, 35K57, 57S20.

Keywords and Phrases: spiral waves, equivariant dynamical systems, noncompact groups.

1 INTRODUCTION

1.1 SPIRAL WAVE DYNAMICS

Relative equilibria and relative periodic solutions are ubiquitous in systems with continuous symmetry. Examples of relative equilibria and relative periodic solutions are spiral waves. Spiral waves have been observed in various chemical and biological systems, for example in the Belousov-Zhabotinsky reaction [5], [26], [35], and in catalysis on platinum surfaces [16].

The spiral tip of a rigidly rotating spiral wave moves on a circle. In mathematical terms rigidly rotating spiral waves are rotating waves. Rotating waves are stationary in a corotating frame and therefore examples of relative equilibria. Meandering spiral waves are modulated rotating waves, i.e., they are periodic in

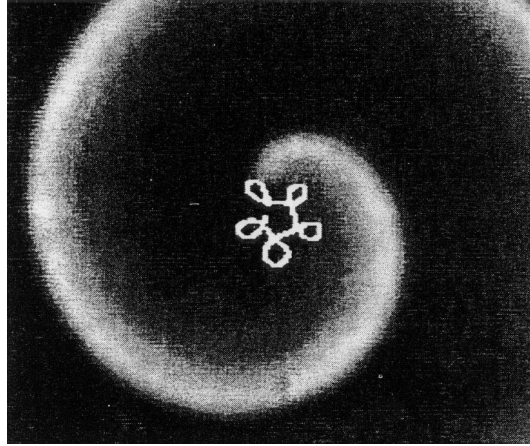

Figure 1: Meandering spiral wave in the Belousov Zhabotinsky reaction, from Steinbock et al. [27], with kind permission of Nature. The tip trajectory is overlaid with a white curve.

a corotating frame. In this case the spiral tip performs a quasiperiodic motion, which is called meandering, see Fig. 1.

Meandering spiral waves are generated by external periodic forcing of rigidly rotating spiral waves [16]. Let ω_{ext} be the frequency of the external forcing and let μ_{ext} be its amplitude. If the periodic forcing is resonant, i.e., if the rotation frequency ω_{rot}^* of the rigidly rotating wave at $\mu_{\text{ext}} = 0$ is a multiple of the external frequency ω_{ext} of the system then a curve of drifting spiral waves in the $(\omega_{\text{ext}}, \mu_{\text{ext}})$ -plane is observed which separates modulated rotating wave states with inward petals and outward petals, cf. [16]. This phenomenon is called resonance drift. Drifting spiral waves, see Fig. 2, are modulated

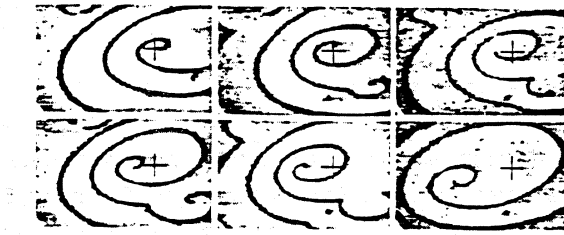

Figure 2: Drifting Spiral Waves in the CO-Oxidation on Pt(110), courtesy of [16]. The cross is always at the same position. So we see that the spiral wave drifts away from the cross.

travelling waves, i.e., they are periodic in a comoving frame. Both, meandering and drifting spiral waves are examples of relative periodic orbits.

In experiments also meandering spiral waves have been forced periodically [35]. Here invariant 3-tori are found and frequency locking between the period of the relative periodic orbits and the period of the external forcing occurs. Furthermore for certain external periods modulated travelling waves are generated. Experimentalists call this phenomenon generalized resonance drift [35].

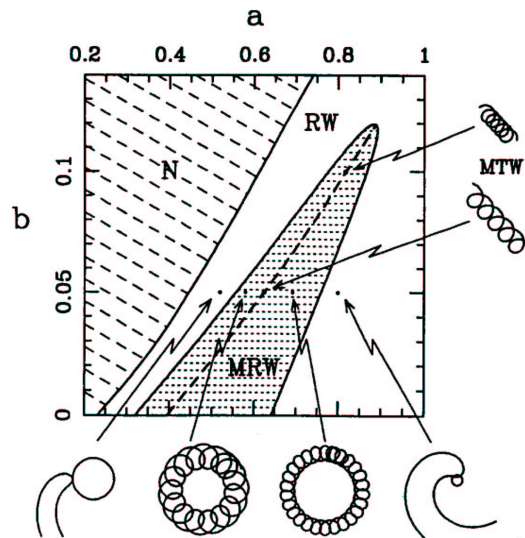

Figure 3: Phase diagram for the spiral wave dynamics depending on the parameters a , b ; courtesy of Barkley [4]. Shown are regions containing N: no spiral waves, RW: stable rigidly rotating waves, MRW: modulated rotating waves, MTW: modulated travelling waves (dashed curve). Spiral tip paths illustrate states at 6 points. Small portions of spiral waves are shown for the two rotating wave cases.

Meandering spiral waves can also emanate from rigidly rotating spiral waves by a spontaneous bifurcation in autonomous systems, see [26], [32]. Barkley found in numerical simulations [3], see Fig. 3, that this transition is a Hopf bifurcation in the corotating frame. Hopf-bifurcation in autonomous systems leads to analogous drifting phenomena as periodic forcing of rigidly rotating waves.

The media in which spiral waves occur can be modelled by reaction-diffusion systems of the form

$$\frac{\partial u_i}{\partial t} = \delta_i \Delta u_i + f_i(u, t, \mu), \quad i = 1, \dots, M. \quad (1.1)$$

Here $u = (u_1, \dots, u_M)$ is a vector of concentrations of chemical species, the functions u_i , $i = 1, \dots, M$, map the plane \mathbb{R}^2 to \mathbb{R} , the constants $\delta_i \geq 0$, $i = 1, \dots, M$, are diffusion coefficients, $\mu \in \mathbb{R}^p$ is a parameter, and the functions f_i , $i = 1, \dots, M$, are reaction-terms which are autonomous or time-periodic. Barkley [4] was the first to notice the importance of the Euclidean symmetry for spiral wave dynamics. The Euclidean group $E(2) = O(2) \ltimes \mathbb{R}^2$ of rotations, translations and reflections on the plane acts on the functions $u(x)$, $x \in \mathbb{R}^2$, via

$$(\rho_{(R,a)}u)(x) = u(R^{-1}(x - a)), \quad \text{where } R \in O(2), a \in \mathbb{R}^2. \quad (1.2)$$

System (1.1) is equivariant with respect to the symmetry group $E(2)$.

In this article we want to study the transition from rigidly rotating to meandering spiral waves on the infinitely extended plane \mathbb{R}^2 . More generally the aim of the paper is to understand the transition from relative equilibria to relative periodic orbits in equivariant systems. Furthermore we want to explain the drift and resonance effects which we just described for general symmetry groups. We will discuss implications of our results on spiral wave dynamics in the plane and on the sphere (for simulations of spiral waves on the sphere see [36]). Further we want to apply our results to the evolution of scroll-waves in three-dimensional excitable media. Scroll waves have been studied numerically for example in [15], [18].

1.2 RELATED LITERATURE

In the thesis [33] the first results on bifurcations from rotating waves in systems with a non-compact, non-commutative symmetry group have been obtained. This paper is based on the dissertation [33]; but whereas in [33] we restricted attention to the symmetry group $E(2)$ and applications in spiral wave dynamics in this article we treat arbitrary symmetry groups. As in [33] we study the transition from relative equilibria to relative periodic orbits using Lyapunov-Schmidt reduction.

Shortly after [33] was finished a whole bunch of papers on spiral wave dynamics and non-compact symmetry groups appeared:

Golubitsky et al. [10] used a formal center-bundle construction to derive ordinary differential equations describing bifurcations near ℓ -armed planar spiral waves of autonomous reaction-diffusion systems and derived new conditions for drifting. In [1] the drift of relative equilibria and periodic orbits along their group orbit is analyzed for general non-compact groups. Fiedler et al. [7] clarified the structure of the autonomous ordinary differential equations near relative equilibria with compact isotropy for general non-compact groups and gave conditions for drifting. In [21], [22] we presented a center-manifold reduction near relative equilibria and derived rigorously the ordinary differential equations on the center-manifold which were already guessed in [4] and formally derived in [10]. In [23] we extended these results to relative periodic orbits. In [8] normal forms near relative equilibria of non-compact group actions are computed. In [34] bifurcations from relative periodic orbits are treated.

Scheel [24], [25] proved the existence of rotating waves in unbounded domains. The thesis [33] was inspired by work of Renardy on bifurcations from rotating waves [19]. Renardy also studied bifurcations from rotating waves of semilinear differential equations using Lyapunov-Schmidt reduction and applied his results to the Laser equations [20]. But his results for partial differential equations are restricted to compact symmetry groups.

1.3 LYAPUNOV-SCHMIDT-REDUCTION VERSUS CENTER-MANIFOLD THEORY

To analyze bifurcations there are mainly two reduction methods: center-manifold reduction and Lyapunov-Schmidt reduction. Both have advantages and disadvantages. Here we will use Lyapunov-Schmidt reduction as tool for the analysis of bifurcations; for a center-manifold approach see [21], [22]. The advantage of Lyapunov-Schmidt reduction versus center-manifold theory is that we obtain C^∞ -paths of relative periodic orbits if the nonlinearity in (1.1) is C^∞ whereas we only obtain a C^k -smooth center-manifold, $k < \infty$. Besides this we do not need the assumptions that the group action is isometric and that the group orbit of the relative equilibrium is an embedded manifold which are necessary for the center-manifold reduction. Finally the proofs are simpler since they do not rely upon the highly developed invariant manifold machinery. On the other hand the Lyapunov-Schmidt method is limited to relative equilibria and relative periodic orbits – we cannot handle more complicated dynamics. But for our purposes this is sufficient.

1.4 ORGANIZATION OF THE PAPER

The paper is organized as follows.

First, in subsections 1.5 and 1.6 we study the functional-analytic framework of spiral wave dynamics and show some of the difficulties arising in the mathematical treatment of spiral waves. In subsection 1.7 we define an appropriate abstract setting which covers the reaction-diffusion system (1.1) modelling spiral wave dynamics. In this abstract setting we henceforth work. In section 2 we study periodic forcing of relative equilibria and relative periodic orbits. First, in subsection 2.1 we consider periodic forcing of relative equilibria and resonance drift. In subsection 2.3 we study the scaling of the drift velocity. As example we consider periodic forcing of rotating waves in $E(2)$ -equivariant systems which lead to modulated rotating waves or, in the resonance case, to modulated travelling waves. This explains the experiments described in subsection 1.1. In subsection 2.4 we consider resonant periodic forcing of relative periodic orbits and discuss conditions for generalized resonance drift. The results apply to periodic forcing of meandering spiral waves as investigated experimentally by [35], see also subsection 1.1. In section 3 we discuss Hopf bifurcation from relative equilibria, resonances, scaling of drift velocity and effects of spatial isotropy of the relative equilibrium. As an example we study the Hopf bifurcation from multi-armed spiral waves. Section 4 is devoted to the proof of the main results.

1.5 FUNCTIONAL-ANALYTIC FRAMEWORK

To describe spiral wave dynamics we consider reaction-diffusion systems of the form (1.1) on a domain $\Omega \subset \mathbb{R}^3$ to \mathbb{R} , where Ω is a C^∞ -manifold without boundary, for example \mathbb{R}^2 , the unit sphere S^2 in \mathbb{R}^3 or \mathbb{R}^3 itself. The reaction-terms f_i , $i = 1, \dots, M$, are assumed to be C^k -smooth functions where $k \in \mathbb{N}$. The domain Ω is invariant under some subgroup G of the Euclidean group $E(3)$ of motions in three-dimensional space consisting of rotations, reflections and translations. The group $E(3) = O(3) \times \mathbb{R}^3$ acts on the functions $u(x)$, $x \in \mathbb{R}^3$, via (1.2), i.e.,

$$(\rho_{(R,a)}u)(x) = u(R^{-1}(x - a)), \quad \text{where } R \in O(3), a \in \mathbb{R}^3.$$

System (1.1) is equivariant with respect to the group G . If $G = E(2)$ is the Euclidean group of motions in the plane we write (ϕ, a) for (R_ϕ, a) where R_ϕ is a rotation with angle ϕ and $a \in \mathbb{R}^2$.

We consider (1.1) in the space of bounded uniformly continuous functions $X = BC_{\text{unif}}(\Omega, \mathbb{R}^M)$ or in the space $X = L^2(\Omega, \mathbb{R}^M)$.

In $X = BC_{\text{unif}}$ we get a time-evolution Φ_{t,t_0} of (1.1) on $Y = X$; if $X = L^2$ we obtain a time-evolution on $Y = X^\alpha$, $\alpha > 1/2$ without any growth conditions on f provided that $f(0, t, \mu) = 0$ for all t, μ and $\delta_i > 0$, $i = 1, \dots, M$. If $\delta_i = 0$ for some i we still obtain a semiflow on $X = H^2$ provided that $f(0, t, \mu) \equiv 0$.

Note that the group action is not smooth on the whole function space X . If the domain is $\Omega = \mathbb{R}^2$ and we choose $X = BC_{\text{unif}}(\mathbb{R}^2, \mathbb{R}^M)$ then the $E(2)$ -action is even not strongly continuous because on the function $u(x_1, x_2) = \cos x_1$ the rotation acts discontinuously: For large radius r the term $|(\rho_{(\phi,0)}u)(x) - u(x)|$ can become equal to 2 even for arbitrarily small ϕ . We encounter the same problem if $\Omega = \mathbb{R}^3$. Since we want to have a strongly continuous group action on our base space X we consider the reaction-diffusion system (1.1) on a subspace of BC_{unif} which is invariant under the semiflow and where the group acts in a strongly continuous way:

We define $BC_{\text{Eucl}}(\mathbb{R}^N, \mathbb{R}^M)$ as the subspace of $BC_{\text{unif}}(\mathbb{R}^N, \mathbb{R}^M)$ on which $E(N)$ acts continuously, $N = 2, 3$. The Laplacian is sectorial on $X = BC_{\text{unif}}$ and on L^2 , see [13]. We will now show that the Laplacian is also sectorial on $X = BC_{\text{Eucl}}(\mathbb{R}^N, \mathbb{R}^M)$: let Y be any Banach space with a group G acting on it by a (not necessarily strongly continuous) representation ρ_g , $g \in G$. Let Y_0 be the subspace of Y on which G acts strongly continuously. If A is sectorial on Y and $A\rho_g = \rho_g A$ for all $g \in G$ then A is sectorial in Y_0 : from $\rho_g e^{-At} = e^{-At} \rho_g$ we deduce that $(e^{-At})_{t \geq 0}$ is a C^0 -semigroup from Y_0 to Y_0 ; furthermore $e^{-At}y$ is complex differentiable in t for $y \in Y$, $t > 0$, with derivative $Ae^{-At}y \in Y$. Since $\rho_g Ae^{-At} = Ae^{-At} \rho_g$ and therefore $Ae^{-At}Y_0 \subset Y_0$ we conclude that $(e^{-At})_{t \geq 0}$ is an analytic semigroup on Y_0 . Since $(\lambda - A)^{-1}u \in Y_0$ for $u \in Y_0$, $\lambda \in \mathbb{C}$, $\lambda \notin \text{spec}_Y(A)$, the spectrum of A on Y_0 is contained in the spectrum of A on Y . Especially the Laplacian is sectorial on BC_{Eucl} , and its spectrum is contained in the spectrum of the Laplacian defined on BC_{unif} .

We also get a time-evolution of (1.1) in $BC_{\text{Eucl}}(\mathbb{R}^N, \mathbb{R}^M)$ because we have $\rho_g \Phi_{t,t_0}(u) = \Phi_{t,t_0}(\rho_g u)$ and therefore Φ_{t,t_0} maps Y_0 into itself. Now we have a C^0 -group action on $X = BC_{\text{Eucl}}$, but if $\Omega = \mathbb{R}^2, \mathbb{R}^3$ the semiflow does not smoothen the group-action even if all diffusion coefficients δ_i are positive. We demonstrate this for $\Omega = \mathbb{R}^2$ and for the heat equation where the nonlinearity f is zero.

We will show that on \mathbb{R}^2 the operator $\frac{\partial}{\partial \phi}$ is not bounded w.r.t. the Laplacian Δ and to the semiflow $(e^{\Delta t})_{t \geq 0}$:

REMARK 1.1 *The operator $\frac{\partial}{\partial \phi}$ is not bounded relatively to the Laplacian Δ or relatively to the semiflow $e^{\Delta t}$, $t \geq 0$, on $BC_{\text{unif}}(\mathbb{R}^2, \mathbb{R})$ and $BC_{\text{Eucl}}(\mathbb{R}^2, \mathbb{R})$.*

PROOF. The functions $w_{\ell,b}(x) := J_\ell(b|x|)e^{i\ell \arg(x)}$ where $b \geq 0$ and J_ℓ is the ℓ -th Bessel function of the first kind are elements of $BC_{\text{Eucl}}(\mathbb{R}^2, \mathbb{R}) \subset BC_{\text{unif}}(\mathbb{R}^2, \mathbb{R})$ and they are eigenfunctions of the Laplacian Δ and of the angle derivative $\frac{\partial}{\partial \phi}$:

$$\frac{\partial}{\partial \phi} w_{\ell,b} = i\ell w_{\ell,b}, \quad \Delta w_{\ell,b} = -b^2 w_{\ell,b}.$$

Since $i\ell(1+b^2)^{-1}$ and $i\ell e^{-b^2 t}$ are not bounded for arbitrary $b \in \mathbb{R}$, $\ell \in \mathbb{N}_0$, we conclude that $\frac{\partial}{\partial \phi}$ is not bounded relatively to Δ on $BC_{\text{Eucl}}(\mathbb{R}^2, \mathbb{R})$, $BC_{\text{unif}}(\mathbb{R}^2, \mathbb{R})$ and that $\frac{\partial}{\partial \phi} e^{\Delta t}$ is not a bounded operator on $BC_{\text{Eucl}}(\mathbb{R}^2, \mathbb{R})$, $BC_{\text{unif}}(\mathbb{R}^2, \mathbb{R})$ for $t \geq 0$. ■

REMARK 1.2 *Also on $L^2(\mathbb{R}^2, \mathbb{R})$ the angle-derivative $\frac{\partial}{\partial \phi}$ is not bounded relatively to Δ or $e^{\Delta t}$, $t \geq 0$.*

PROOF. By direct computation we see that $\mathcal{F}(\frac{\partial}{\partial \phi} u) = \frac{\partial}{\partial \phi} \mathcal{F}(u)$. Here $\mathcal{F}(u)$ denotes the Fourier transform of u . From this formula and from $\mathcal{F}(\Delta u)(x) = -|x|^2 \mathcal{F}(u)(x)$ we deduce that $\frac{\partial}{\partial \phi}$ is not bounded with respect to Δ . Furthermore the operator $\frac{\partial}{\partial \phi}$ is not bounded relatively to $e^{\Delta t}$ in $L^2(\mathbb{R}^2, \mathbb{R})$ since $(\mathcal{F}(\frac{\partial}{\partial \phi} e^{\Delta t} u))(x) = \frac{\partial}{\partial \phi} e^{-|x|^2 t} (\mathcal{F}(u))(x)$ is not defined for all $u \in L^2(\mathbb{R}^2, \mathbb{R})$. ■ Therefore we cannot simply change coordinates into a corotating frame to deal with the meandering transition.

1.6 REPRESENTATIONS OF $E(N)$

The function spaces $Y = BC_{\text{Eucl}}(\mathbb{R}^N, \mathbb{R}), L^2(\mathbb{R}^N, \mathbb{R})$, $N = 2, 3$, do not contain finite-dimensional subspaces which are $E(N)$ -invariant and in which the $E(N)$ -action is non-trivial. Again we will demonstrate this in the case $\Omega = \mathbb{R}^2$, $G = E(2)$:

LEMMA 1.3 *Let the action of $E(2)$ on the spaces $X = BC_{\text{Eucl}}(\mathbb{R}^2, \mathbb{R})$, $X = L^2(\mathbb{R}^2, \mathbb{R})$ be given by (1.2). Then the function spaces BC_{Eucl} , L^2 do not contain finite-dimensional $E(2)$ -invariant subspaces with nontrivial $E(2)$ -action.*

In Greenleaf [12] a general theory on the action of topological groups on function spaces is developed.

If we allow polynomial growth in our function space then the polynomials of degree $\leq j$ are finite-dimensional representations of $E(2)$.

PROOF OF LEMMA 1.3. Let $V_j = \text{span}(e_1, \dots, e_j)$ be a j -dimensional representation of $E(2)$ in BC_{unif} or L^2 . Then the translations act as a C^0 -group of isometries on V_j since they act in such a way on BC_{unif} , L^2 . Since V_j is finite-dimensional, we know that $\rho_{(0,(a_1,a_2))}e_i = \sum_{i=1}^j (e^{\eta_1 a_1 + \eta_2 a_2})_{ij} e_j$ where $\eta_1 = \frac{\partial}{\partial x_1}|_{V_j}$, $\eta_2 = \frac{\partial}{\partial x_2}|_{V_j}$ are (j, j) -matrices. Since $\rho_{(0,a)}$ is an isometry we conclude that $\text{Respec}(\eta_1) = \text{Respec}(\eta_2) = 0$ and that η_1, η_2 do not contain Jordan blocks. After simultaneous diagonalization of η_1, η_2 (note that $[\eta_1, \eta_2] = 0$) we see that the eigenfunctions of η_1, η_2 are of the form e^{ibx} , $b, x \in \mathbb{R}^2$. These functions are not elements of $X = L^2(\mathbb{R}^2, \mathbb{R})$. So the proof is finished for the function space L^2 . If we choose $b = 0$ we obtain an $E(2)$ -invariant subspace of $X = BC_{\text{unif}}(\mathbb{R}^2, \mathbb{R})$ which consists of all constant functions. The $E(2)$ -action on this space is trivial. The action of the rotation is not continuous on the functions e^{ibx} , $b \neq 0$, with respect to the norm $\|\cdot\|_{BC_{\text{unif}}(\mathbb{R}^2, \mathbb{R})}$. Therefore the functions e^{ibx} do not span a finite-dimensional $E(2)$ -invariant subspace of $BC_{\text{Eucl}}(\mathbb{R}^2, \mathbb{R})$ for $b \neq 0$. ■

Of course, the same considerations apply for $x \in \mathbb{R}^3$, $G = E(3)$ instead of $x \in \mathbb{R}^2$, $G = E(2)$.

Especially for an $E(2)$ -invariant steady state the eigenspace to each eigenvalue is $E(2)$ -invariant and therefore infinite-dimensional. This makes the study of bifurcations from $E(2)$ -invariant equilibria for an abstract equivariant parabolic equation very difficult. We will not attack this problem and rather study bifurcations from relative equilibria where these difficulties do not occur. Bifurcations from homogeneous steady states of reaction diffusion equations have been studied by Scheel [24], [25] using spatial dynamics.

1.7 ABSTRACT SETTING

In this paper we study semilinear parabolic equations

$$\frac{du}{dt} = -Au + f(u, \omega_{\text{ext}}t, \mu) \quad (1.3)$$

on some Banach space X which are equivariant under a m -dimensional Lie group G which may be non-compact. We assume that A is sectorial (for a definition see [13]) and that f is C^k -smooth from $Y \times \mathbb{R} \times \mathbb{R}^p$ to X . Here $k \in \mathbb{N}$ or $k = \infty$, $\mu \in \mathbb{R}^p$ and $Y = X^\alpha$ for $0 \leq \alpha < 1$.

By [13] there exists a time-evolution $\Phi_{t,t_0}(\cdot; \mu)$ of (1.3) on Y , and $\Phi_{t,t_0}(u; \mu)$ is C^k -smooth in u, μ for $t \geq t_0$ and in u, μ, t, t_0 for $t > t_0$. We assume that the group G acts on Y by the linear strongly continuous representation $\rho_g \in \mathcal{L}(Y)$, $g \in G$ and that (1.3) is G -equivariant, i.e.,

$$\forall g \in G \quad \rho_g A = A \rho_g, \quad f(\rho_g u, t, \mu) = \rho_g f(u, t, \mu)$$

This implies that $\rho_g \Phi_{t,t_0}(\cdot; \mu) = \Phi_{t,t_0}(\rho_g \cdot; \mu)$ for all $g \in G$.

Assume that f in (1.3) is time-independent. Then a group orbit Gu^* is called a *relative equilibrium* of (1.3) if $\Phi_t(u^*) = \rho_{\exp(\xi^* t)} u^*$ for some $\xi^* \in \text{alg}(G)$. Here $\text{alg}(G)$ denotes the Lie algebra of G . Sometimes we denote u^* itself as relative equilibrium.

A point u^* lies on a *relative periodic orbit*

$$\mathcal{O}^* = \{\rho_g \Phi_{t,0}(u^*) \mid g \in G, t \in \mathbb{R}\}$$

if $\Phi_{T^*,0}(u^*) = \rho_{g^*} u^*$ for some $T^* > 0$, $g^* \in G$. In this case we suppose that $f(u, \omega_{\text{ext}} t, \mu)$ is independent of time or time-periodic with frequency $\omega_{\text{ext}} = 2\pi j/T^*$, $j \in \mathbb{N}$. Sometimes we sloppily denote u^* itself as relative periodic orbit. We call T^* the relative period of the relative periodic orbit.

The aim of this article is to study transitions from relative equilibria to relative periodic orbits of (1.3).

2 PERIODICALLY FORCED G -EQUIVARIANT SYSTEMS

This section deals with the effects of periodic forcing on relative equilibria and relative periodic orbits. In particular, we will investigate drift phenomena caused by resonant periodic forcing. We will apply our results to spiral wave dynamics. This helps to understand the experiments mentioned in the introduction. Proofs of the main theorems are postponed to section 4.

In this section we assume that the nonlinearity f of (1.3) is of the form

$$f(u, t, \mu) = \hat{f}(u, \hat{\mu}) + \mu_{\text{ext}} f_{\text{ext}}(u, \omega_{\text{ext}} t, \mu).$$

Here $f_{\text{ext}}(u, \tau, \mu)$ is 2π -periodic in τ ; ω_{ext} is the frequency of the periodic forcing, $T_{\text{ext}} = \frac{2\pi}{\omega_{\text{ext}}}$ is its period, μ_{ext} is its amplitude and we decompose $\mu = (\mu_{\text{ext}}, \hat{\mu})$, where $\mu_{\text{ext}} \in \mathbb{R}$, $\hat{\mu} \in \mathbb{R}^{p-1}$. So we consider the periodically forced differential equation

$$\frac{du}{dt} = -Au + \hat{f}(u, \hat{\mu}) + \mu_{\text{ext}} f_{\text{ext}}(u, \omega_{\text{ext}} t, \mu). \quad (2.1)$$

A typical example of the abstract semilinear differential equation (2.1) is a periodically forced reaction-diffusion system on the domain $\Omega \subset \mathbb{R}^N$, $N = 2, 3$, cf. (1.1):

$$\frac{\partial u_i}{\partial t} = \delta_i \Delta u_i + \hat{f}_i(u, \hat{\mu}) + \mu_{\text{ext}} f_{\text{ext},i}(u, \omega_{\text{ext}} t, \mu), \quad i = 1, \dots, M. \quad (2.2)$$

2.1 PERIODIC FORCING OF RELATIVE EQUILIBRIA

This subsection deals with effects of periodic forcing on relative equilibria. First we state two general theorems, then we study examples in spiral wave dynamics.

Consider system (2.1) without periodic forcing, i.e., at $\mu_{\text{ext}} = 0$. Assume that u^* is a relative equilibrium of the unforced system for the parameter $\hat{\mu} = \hat{\mu}^* = 0$. Then u^* satisfies

$$\Phi_t(u^*) = \rho_{e^{t\xi^*}} u^*$$

for some $\xi^* \in \text{alg}(G)$. Since $\Phi_t(\cdot)$ is equivariant and C^k -smooth in t for $t > 0$ we conclude that $e^{t\xi^*} u^*$ is C^k -smooth in t for all $t \in \mathbb{R}$.

We will write ξu for $\frac{d}{dt} \rho_{e^{t\xi}} u|_{t=0}$. Furthermore denote by

$$\text{Ad}_g \xi := g \xi g^{-1} = \left. \frac{d}{dt} (g \exp(\xi t) g^{-1}) \right|_{t=0} \in \text{alg}(G)$$

the adjoint action of G on $\text{alg}(G)$ and by

$$K = \{g \in G \mid \rho_g u^* = u^*\}$$

the isotropy group of u^* . We assume that K is compact. Let G^0 denote the identity component of G . We have $\xi^* \in \text{alg}(N(K))$ where $N(K)$ is the normalizer of the isotropy group K of u^* because for $g \in K$, $t \in \mathbb{R}$,

$$\rho_g \rho_{\exp(t\xi^*)} u^* = \rho_g \Phi_t(u^*) = \Phi_t(\rho_g u^*) = \Phi_t(u^*) = \rho_{\exp(t\xi^*)} u^*$$

and therefore $g \exp(t\xi^*) \in \exp(t\xi^*)K$. Similarly the pull-back element g^* of a relative periodic orbit $u^* = \rho_{g^*}^{-1} \Phi_{T_{\text{ext},0}}(u^*)$ lies in the normalizer of the isotropy K of u^* . Actually for a relative equilibrium the drift velocity ξ^* lies in the Lie algebra of the centralizer $Z(K)$ of K , which follows from the formula $N(K)^0 = K^0 Z(K)^0$, see [9].

Since by periodic forcing isotropy is not changed we assume without loss of generality in the whole section that $K = \{\text{id}\}$. Otherwise we change the space Y to the fixed point space $\text{Fix}(K) = \{g \in G, \rho_g u^* = u^*\}$ of K and the symmetry group G to $N(K)/K$.

Let u^* be a relative equilibrium, i.e., $-Au^* + \hat{f}(u^*) = \xi^* u^*$, and let

$$L^* = -A + D_u \hat{f}(u^*) - \xi^*$$

be the linearization at the relative equilibrium in the comoving frame. Assume that $\rho_g u^*$ is C^1 in $g \in G$. We compute that for $\xi \in \text{alg}(G)$

$$\begin{aligned} L^* \xi u^* &= (-A + D_u \hat{f}(u^*) - \xi^*) \xi u^* \\ &= -\xi A u^* + D_u \hat{f}(u^*) \xi u^* - \xi^* \xi u^* \\ &= \xi(-A + \hat{f}(u^*)) - \xi^* \xi u^* \\ &= (\xi \xi^* - \xi^* \xi) u^* \\ &= [\xi, \xi^*] u^* = -\text{ad}_{\xi^*} u^*. \end{aligned} \tag{2.3}$$

Here $[\cdot, \cdot]$ denotes the commutator, $\text{ad}_{\xi^*}(\xi) = [\xi^*, \xi]$ and we used that $g \hat{f}(u) = \hat{f}(gu)$ and therefore $D_u \hat{f}(u^*) \xi = \xi \hat{f}(u)$. From (2.3) we see that L^* maps $T_{u^*} G u^* = \text{alg}(G) u^*$ into itself.

EXAMPLE 2.1 Let u^* be a rotating wave of the unforced system (2.1), e.g a rigidly rotating spiral wave of the reaction-diffusion system (2.2) on $\Omega = \mathbb{R}^2$ at $\mu_{\text{ext}} = 0$. Then the symmetry group is $G = \text{E}(2)$. We write $g = (\phi, a) \in \text{SO}(2) \ltimes \mathbb{R}^2 = \text{SE}(2)$. Let ξ_1 denote the generator of the rotation and ξ_2, ξ_3 denote the generators of the translation. Then $\xi^* = \omega_{\text{rot}}^* \xi_1$ where ω_{rot}^* is the rotation frequency of the spiral, and we compute

$$L^* \xi_1 u^* = 0, \quad L^*(\xi_2 + i\xi_3)u^* = \omega_{\text{rot}}^* [\xi_2 + i\xi_3, \xi_1]u^* = i\omega_{\text{rot}}^* (\xi_2 + i\xi_3)u^*.$$

Therefore the linearization L^* of the rotating wave in the rotating frame has always eigenvalues on the imaginary axis.

For a relative periodic orbit $u^* = \rho_{g^*}^{-1} \Phi_{T^*,0}(u^*)$ with $\rho_g u^* \in C^1$ in g we get

$$\rho_{g^*}^{-1} \text{D}\Phi_{T^*,0}(u^*) \xi u^* = (\text{Ad}_{g^*}^{-1} \xi) u^*, \quad \xi \in \text{alg}(G).$$

If u^* is a relative equilibrium then the linearization of the time- T -map in the comoving frame ξ_* is given by

$$e^{L^* T} = \rho_{g^*}^{-1} \text{D}\Phi_T(u^*)$$

where $g^* = e^{T\xi^*}$.

For the groups relevant in applications (compact and Euclidean groups) the eigenvalues of the linear maps $[\xi, \cdot]$, $\xi \in \text{alg}(G)$, on $\text{alg}(G)$ are purely imaginary and similarly the spectrum of the maps Ad_g , $g \in G$, on $\text{alg}(G)$ lies on the unit circle. We will restrict our attention to these groups in this article. So we make the overall hypothesis

OVERALL HYPOTHESIS *The spectra of the linear maps Ad_g , $g \in G$, are subsets of the unit circle $\{\lambda \in \mathbb{C}; |\lambda| = 1\}$.*

Therefore in the case of continuous symmetry where $\text{alg}(G)$ is nontrivial the linearization L^* at a relative equilibrium always has eigenvalues on the imaginary axis and similarly the linearization $\rho_{g^*}^{-1} \text{D}\Phi_T(u^*)$ of a relative periodic orbit $u^* = \rho_{g^*}^{-1} \Phi_T(u^*)$ of (2.1) has always center-eigenvalues on the unit circle. If u^* is a relative equilibrium fix some $T > 0$. In the case of a relative periodic orbit take $T = T^*$. We need the following assumption on the spectrum:

HYPOTHESIS (S) *The set $\{\lambda \in \mathbb{C}; |\lambda| \geq 1\}$ is a spectral set for the spectrum $\text{spec}(B^*)$ of the operator*

$$B^* := \rho_{g^*}^{-1} \text{D}\Phi_T(u^*) \in \mathcal{L}(Y) \tag{2.4}$$

(called center-unstable spectral set) with associated spectral projection $P \in \mathcal{L}(Y)$ and the corresponding generalized eigenspace $E_{\text{cu}} := \mathcal{R}(P)$ (the center-unstable eigenspace) is finite-dimensional.

We will show in Section 4 below that Hypothesis (S) implies that $\rho_g u^*$ is C^k in g . Let $Gu^* = \{\rho_g u^*; g \in G\}$ denote the group orbit at u^* . Frequently we employ the following notion:

DEFINITION 2.2 *We say that a relative periodic orbit or a relative equilibrium u^* of (2.1) is non-critical if $\rho_g u^*$ is C^1 in g and if the operator B^* from (2.4) satisfies Hypothesis (S) and if the center-eigenspace*

$$E_c = T_{u^*} G u^* + \text{span}(\partial_t \Phi_t(u^*)|_{t=0})$$

only consists of eigenvectors which are forced by G -symmetry or time-shift symmetry (in the case of relative periodic orbits of autonomous systems).

Denote the dual space of Y by Y^* , let $m = \dim(G)$ and assume that $\rho_g u^*$ is C^1 in g . Choose $l_i \in Y^*$, $i = 1, \dots, m$, such that the equations $l_i(u - u^*) = 0$, $i = 1, \dots, m$, define a section $S_l = u^* + \hat{S}_l$ transverse to the group orbit $G u^*$ of the relative equilibrium at u^* . If u^* is non-critical we can choose the functionals l_i as left center-eigenvectors of L^* .

The following theorem essentially states that external periodic forcing leads to a transition from relative equilibria to relative periodic orbits.

THEOREM 2.3 *Let $u^* = \rho_{e^{-t\xi^*}} \Phi_t(u^*)$ be a relative equilibrium of the unforced system (2.1), i.e., for the parameter $\mu = 0$. Compute $B^* = e^{T_{\text{ext}}^* L^*}$ as in (2.4) and assume that u^* satisfies assumption (S). Then $\rho_g u^*$ is C^k in g .*

If the generalized eigenspace of B^ to the eigenvalue 1 lies in $\text{alg}(G)u^*$ then for each small amplitude μ_{ext} of the periodic forcing, each frequency $\omega_{\text{ext}} \approx \omega_{\text{ext}}^*$ of the forcing and each small $\hat{\mu}$ there is exactly one relative periodic orbit $u = u(\omega_{\text{ext}}, \mu)$, of (2.1) satisfying*

$$u = \rho_g^{-1} \Phi_{T_{\text{ext},0}}(u, \mu) \quad \text{and} \quad u \in S_l, \quad (2.5)$$

for some $g = g(\omega_{\text{ext}}, \mu)$. Furthermore $\rho_g u(\omega_{\text{ext}}, \mu)$ is C^k in $g \in G$, ω_{ext} and μ , $g(\omega_{\text{ext}}, \mu)$ is C^k in $(\omega_{\text{ext}}, \mu)$ and $u(\omega_{\text{ext}}, 0) = u^$, $g(\omega_{\text{ext}}, 0) = g^*$.*

Often we need not use the full symmetry G of (3.1) to prove Theorem 2.3. If L^* does not have eigenvalues $ij\omega_{\text{ext}}^*$, $j \in \mathbb{Z}$, forced by symmetry then the symmetry group is discrete and we need not take it into account to prove the theorem. If $[\cdot, \xi^*]$ has eigenvalues in $i\omega_{\text{ext}}^* \mathbb{Z}$, then the corresponding (generalized) eigenvectors form a Lie-subalgebra of $\text{alg}(G)$ as can be seen from the Jacobi-identity.

We call the Lie group generated by the generalized eigenvectors of $[\cdot, \xi^*]$ to the spectral set $i\omega_{\text{ext}}^* \mathbb{Z}$ the *minimal symmetry group* for the forcing frequency ω_{ext}^* that we consider.

2.2 RESONANCE DRIFT

Now we deal with the effects of resonant periodic forcing. We need the following notion:

DEFINITION 2.4 *Let $g \in G$. If $g^n = \exp(\xi n)$ for some $\xi \in \text{alg}(G)$ with $\text{Ad}_g \xi = \xi$ and $n \in \mathbb{N}$ then we call ξ average velocity of g .*

There may be many average velocities for each group element g ; for example if $G = \text{SO}(2)$ then for $g^* = \phi^*$ the set $\{\xi^* = \phi^* + j2\pi \mid j \in \mathbb{Z}\}$ consists of average velocities for g^* . If $u = \rho_g^{-1}\Phi_{T,0}(u)$ is a relative periodic orbit of (2.1) and ξ is an average velocity of g then we call ξ/T average velocity of the relative periodic orbit.

DEFINITION 2.5 *If $\exp(\cdot)$ is not locally surjective near $\xi^* \in \text{alg}(G)$ then there are elements $g \in G$ close to $\exp(\xi^*)$ which have (if any) only average velocities ξ which are far away from ξ^* . We call this phenomenon resonance drift.*

Similarly, let u^* be a non-critical relative equilibrium of the unperturbed system (2.1) which travels with velocity ξ^* . If the period of the external forcing T_{ext}^* is such that $\exp(\cdot)$ is not locally surjective near $\xi = \xi^* T_{\text{ext}}^*$ then it may happen that relative periodic orbits of (2.1) which are generated by external periodic forcing, see Theorem 2.3, drift with an average velocity completely different to the drift velocity ξ^* of the relative equilibrium at $\mu_{\text{ext}} = 0$. We also call this effect *resonance drift*.

Due to [31, Theorem 2.14.2] we know that the map $(\text{D exp}(\xi^*))\exp(-\xi^*) : \text{alg}(G) \rightarrow \text{alg}(G)$ is given as

$$\begin{aligned} (\text{D exp}(\xi^*))\exp(-\xi^*) &= \sum_{n=0}^{\infty} \frac{(-1)^n}{(n+1)!} (\text{ad}_{\xi^*})^n \\ &= (-\text{ad}_{\xi^*})^{-1} (\exp(-\text{ad}_{\xi^*}) - \text{id}) \end{aligned} \quad (2.6)$$

where $\text{ad}_{\xi^*}(\xi) = [\xi^*, \xi]$. Hence $\exp(\cdot)$ is not locally surjective at ξ^* iff ad_{ξ^*} has eigenvalues in $2\pi i\mathbb{Z} \setminus \{0\}$. Consequently, for resonance drift to occur it is necessary that the periodic forcing is resonant, i.e., that the linearization L^* of the relative equilibrium in the comoving frame has a symmetry eigenvalue in $i\omega_{\text{ext}}^* \mathbb{Z} \setminus \{0\}$. Otherwise $\exp(\cdot)$ would be surjective near $T_{\text{ext}}^* \xi^*$ and the relative periodic orbits $u(\mu)$ generated by periodic forcing would drift with velocity $\xi(\mu) \approx \xi^*$.

As we mentioned in the introduction even a transition from compact to non-compact drift may take place. We will deal with this in the following example:

EXAMPLE 2.6 Consider Example 2.1 again: Let the symmetry group be $G = \text{E}(2)$, write $g = (\phi, a) \in \text{SO}(2) \ltimes \mathbb{R}^2 = \text{SE}(2)$ and let u^* be a non-critical rotating wave $u^* = \rho_{(-\omega_{\text{rot}}^* t, 0)} \Phi_t(u^*)$ of the unforced system (2.1), i.e. for $\mu_{\text{ext}} = 0$. For example u^* could be a rigidly rotating spiral wave of the reaction-diffusion system (2.2) on $\Omega = \mathbb{R}^2$. By Theorem 2.3 for each small forcing amplitude $\mu_{\text{ext}} \approx 0$ and each forcing frequency ω_{ext} there is a relative periodic orbit $u(\omega_{\text{ext}}, \mu_{\text{ext}}) \approx u^*$.

If $\omega_{\text{rot}}^*/\omega_{\text{ext}}^* \notin \mathbb{Z}$ then the forcing is non-resonant and the relative periodic orbits $u(\omega_{\text{ext}}, \mu_{\text{ext}})$ with $\omega_{\text{ext}} \approx \omega_{\text{ext}}^*$ are modulated rotating waves of (2.1) (called meandering spiral waves in the example (2.2)).

If $\omega_{\text{rot}}^*/\omega_{\text{ext}}^* = j \in \mathbb{Z}$ then we see from (2.6) that $\text{D exp}(2\pi\xi^*/\omega_{\text{ext}}^*)$ has rank defect 2. We talk of a $j : 1$ -resonance. In this case modulated travelling waves (called drifting spiral waves of (2.2)) are generated as the following proposition shows:

PROPOSITION 2.7 *If a rotating wave of an $E(2)$ -equivariant system (2.1) is subject to $j : 1$ -resonant periodic forcing then there is a C^k -smooth path $u(\mu_{\text{ext}})$, $a(\mu_{\text{ext}})$, $\omega_{\text{ext}}(\mu_{\text{ext}})$, of modulated travelling waves satisfying*

$$\Phi_{2\pi/\omega_{\text{ext}}(\mu_{\text{ext}})}(u(\mu_{\text{ext}})) = \rho_{(0,a(\mu_{\text{ext}}))}u(\mu_{\text{ext}})$$

such that $u(0) = u^*$, $a(0) = 0$, $\omega_{\text{ext}}(0) = \omega_{\text{ext}}^*$.

PROOF. By Theorem 2.3 we get a surface $u(\omega_{\text{ext}}, \mu_{\text{ext}})$ of relative periodic orbits satisfying (2.5) where $g(\omega_{\text{ext}}, \mu_{\text{ext}}) = (\phi(\omega_{\text{ext}}, \mu_{\text{ext}}), a(\omega_{\text{ext}}, \mu_{\text{ext}}))$. To obtain modulated travelling waves we need to solve the equation

$$\phi(\omega_{\text{ext}}, \mu_{\text{ext}}) = 0 \pmod{2\pi}.$$

We have $\partial_{\omega_{\text{ext}}} \phi(\omega_{\text{ext}}, \mu_{\text{ext}})|_{(\omega_{\text{ext}}, \mu_{\text{ext}}) = (\omega_{\text{ext}}^*, 0)} \neq 0$. This can be seen as follows: Let ξ_1 be the generator of the rotation, and ξ_2, ξ_3 be the generators of the translation. Computing the derivative w.r.t. ω_{ext} of (2.5) in $(\omega_{\text{ext}}, \mu_{\text{ext}}) = (\omega_{\text{ext}}^*, 0)$ we get

$$\begin{aligned} & -\frac{2\pi\omega_{\text{rot}}^*}{(\omega_{\text{ext}}^*)^2} \xi_1 u^* + (D\Phi_{T_{\text{ext}}^*, 0} u^* - 1) \partial_{\omega_{\text{ext}}} u(\omega_{\text{ext}}^*, 0) \\ & = (\partial_{\omega_{\text{ext}}} \phi(\omega_{\text{ext}}^*, 0) \xi_1 + \partial_{\omega_{\text{ext}}} a_1(\omega_{\text{ext}}^*, 0) \xi_2 + \partial_{\omega_{\text{ext}}} a_2(\omega_{\text{ext}}^*, 0) \xi_3) u^*. \end{aligned} \quad (2.7)$$

Here we used that

$$\partial_{\omega_{\text{ext}}} \Phi_{2\pi/\omega_{\text{ext}}^*}(u^*) = -\frac{2\pi}{(\omega_{\text{ext}}^*)^2} \partial_t \Phi_t(u^*)_{t=2\pi/\omega_{\text{ext}}^*} = -\frac{2\pi\omega_{\text{rot}}^*}{(\omega_{\text{ext}}^*)^2} \xi_1 u^*.$$

If we choose the l_i in (2.5) as left center-eigenvectors of L^* then

$$l_i((D\Phi_{T_{\text{ext}}^*, 0} u^* - 1) \partial_{\omega_{\text{ext}}} u(\omega_{\text{ext}}^*, 0)) = 0, \quad i = 1, 2, 3.$$

Applying the functionals l_i , $i = 1, 2, 3$, onto (2.7) we conclude that

$$\partial_{\omega_{\text{ext}}} \phi(\omega_{\text{ext}}^*, 0) = -2\pi\omega_{\text{rot}}^*/(\omega_{\text{ext}}^*)^2 \neq 0.$$

Hence we can apply the implicit function theorem to get a smooth path $\mu_{\text{ext}}(\omega_{\text{ext}})$ parametrizing modulated travelling waves. ■

A transition from rotating waves to modulated travelling waves has been observed in experiments [16] in the case of $1 : 1$ -resonance and $2 : 1$ -resonance. Ashwin and Melbourne [2] talk of drift bifurcation of relative equilibria if a rotating wave of an $E(2)$ -equivariant system becomes a travelling wave in the limit $\omega_{\text{rot}} \rightarrow 0$. So their drift bifurcation and our resonance drift are related. But in our case the resonance drift is enforced by periodic forcing.

EXAMPLE 2.8 Consider the reaction-diffusion system (2.2) on the sphere $\Omega = S^2$. Then the symmetry group is $G = O(3)$. We will show that a wave u^* rotating around the x_3 -axis starts meandering around some vector in the (x_1, x_2) -plane if it is subject to resonant periodic forcing.

Let ξ_i denote the generators of the rotation around the unit vectors $\mathbf{e}_i \in \mathbb{R}^3$, $i = 1, 2, 3$, and write $g \in \text{SO}(3)$ as $g = \exp(\sum_{i=1}^3 \phi_i \xi_i)$. Let $u^* = \rho_{\exp(-\xi^* t)} \Phi_t(u^*)$ be a non-critical wave of the unforced system (2.2), $\mu_{\text{ext}} = 0$, rotating around the x_1 -axis, i.e., $\xi^* = \omega_{\text{rot}}^* \xi_1$. As in (2.3) we compute

$$L^*(\xi_2 + i\xi_3)u^* = i\omega_{\text{rot}}^*(\xi_2 + i\xi_3)u^*.$$

If we switch on resonant periodic forcing with $\omega_{\text{ext}}^* = \omega_{\text{rot}}^*/j$, $j \in \mathbb{Z}$, then there is a smooth path $u(\mu_{\text{ext}})$, $\omega_{\text{ext}}(\mu_{\text{ext}})$ of waves meandering around some vector in the (x_2, x_3) -plane:

$$\Phi_{T_{\text{ext}}(\mu_{\text{ext}}), 0}(u(\mu_{\text{ext}})) = \rho_{\exp(\phi_2(\mu_{\text{ext}})\xi_2 + \phi_3(\mu_{\text{ext}})\xi_3)}u(\mu_{\text{ext}})$$

where $\phi_2(0) = 0$, $\phi_3(0) = 0$, $\omega_{\text{ext}}(0) = \omega_{\text{ext}}^*$, $u(0) = u^*$. This can be seen as in Example 2.6.

For numerical simulations of rotating waves on the sphere S^2 see [36].

In the last two examples of resonant forcing the relative equilibria were always rotating waves. But also for nonperiodic relative equilibria resonance drift occurs:

EXAMPLE 2.9 Consider the reaction-diffusion system (2.2) in three space $\Omega = \mathbb{R}^3$. Then the symmetry group is the Euclidean group $\text{E}(3)$.

Let u^* be a twisted scroll ring of the unforced system (2.2). Such a wave consists of a circular filament in the (x_2, x_3) -plane along which vertical spiral waves are located and an additional infinitely extended vertical filament [18]. It is a relative equilibrium which translates along its vertical filament and simultaneously rotates around it.

Because of the vertical filament only translations $a \in \mathbb{R}^3$ and rotations around the x_3 -axis act continuously on u_* in the space BC_{unif} . So the effective symmetry group is in this case $G = \text{E}(2) \times \mathbb{R}$. cf. [23]. We write $g = (\phi, a)$ for the elements of $\text{E}(2) \times \mathbb{R}$ where ϕ is the rotation angle around the x_1 -axis and $a \in \mathbb{R}^3$ is a translation vector.

The time-evolution of the twisted scroll ring is given by $\Phi_t(u^*) = \rho_{\exp(\xi^* t)}u^*$ where $\xi^* = (\omega_{\text{rot}}^*, v^* \mathbf{e}_1)$.

If the twisted scroll ring is forced periodically with frequency ω_{ext} it will typically start meandering in the (x_2, x_3) -plane:

$$\Phi_{T_{\text{ext}}, 0}(u(\mu_{\text{ext}})) = \rho_{(\phi(\mu_{\text{ext}}), a(\mu_{\text{ext}}))}u(\mu_{\text{ext}}), \quad a(\mu_{\text{ext}}) = v(\mu_{\text{ext}})T_{\text{ext}}\mathbf{e}_1.$$

But by resonant periodic forcing, i.e., if $\omega_{\text{rot}}^*/\omega_{\text{ext}}^* \in \mathbb{Z}$, we can achieve that the scroll ring drifts away in another direction than the x_1 -axis as the following proposition shows:

PROPOSITION 2.10 *If the twisted scroll ring of (2.2) is noncritical and forced periodically such that $\omega_{\text{rot}}^*/\omega_{\text{ext}}^* \in \mathbb{Z}$ then there is a C^k -smooth path $u(\mu_{\text{ext}})$, $\omega_{\text{ext}}(\mu_{\text{ext}})$ of relative periodic orbits satisfying*

$$\Phi_{2\pi/\omega_{\text{ext}}(\mu_{\text{ext}}), 0}(u(\mu_{\text{ext}})) = \rho_{(0, a(\mu_{\text{ext}}))}u(\mu_{\text{ext}}), \quad a(\mu_{\text{ext}}) \in \mathbb{R}^3.$$

The direction of the drift $a(\mu_{\text{ext}})$ of the periodically forced twisted scroll rings in the above proposition will typically not point in x_1 -direction. The proof of the proposition is similar as the proof of Proposition 2.7.

Note again that to the isotropy K of the relative equilibria not all kinds of noncompact drift are possible. As mentioned before the drifts $g(\omega_{\text{ext}}, \mu)$ of the emanating relative periodic orbits have to lie in $N(K)$. Remember that we have chosen $G = N(K)/K$ in the whole section. In a second step we have to interpret our results on periodic forcing for the original group G . In a system with $E(2)$ -symmetry for instance we see that a rotating wave with spatial symmetry K can not start drifting under the influence of the periodic forcing if K contains a non-trivial rotation $(\phi, 0)$. In this case $N(K) = SO(2)$, see [7]. Similarly if $G = E(2)$ and K only consists of one reflection then the relative equilibrium u^* can not rotate. Hence it is a travelling wave in general. A relative equilibrium in an $E(2)$ -equivariant system with $K \supset D_n$, $n > 1$, even has to be stationary.

We can generalize Propositions 2.7, 2.10 as follows: Let $g = \tilde{g}(\chi)$, $\chi \in \mathbb{R}^n$, $|\chi| \leq 1$, be a smooth n -dimensional hyper-surface in G such that $g(0) = g^* = \exp(T_{\text{ext}}^* \xi^*)$. Let $\{\xi_i \mid i = 1, \dots, m\}$, $m = \dim(G)$, denote a basis of $\text{alg}(G)$. Write

$$\tilde{g}(\chi) = \exp(\tilde{\zeta}(\chi))g^*, \quad \tilde{\zeta}(\chi) = \sum_{i=1}^{\dim(G)} \tilde{\zeta}_i(\chi)\xi_i, \quad (2.8)$$

$\tilde{\zeta}_i(0) = 0$, $i = 1, \dots, m$, and assume that $(\partial_{\chi_j} \tilde{\zeta}_i(0))_{i,j=1,\dots,n}$ is an invertible (n, n) -matrix

$$(\partial_{\chi_j} \tilde{\zeta}_i(0))_{i,j=1,\dots,n} \in \text{GL}(n), \quad (2.9)$$

and that

$$\partial_{\chi} \tilde{\zeta}_i(0) = 0 \quad \text{for } i = n+1, \dots, m. \quad (2.10)$$

Let $u^*(\hat{\mu}) = \rho_{\exp(-t \sum_{i=1}^m \zeta_i^*(\hat{\mu})\xi_i)} \Phi_t(u^*(\hat{\mu}))$ be relative equilibria of (2.1) at $\mu_{\text{ext}} = 0$ such that $u^*(0) = u^*$, $\sum_{i=1}^m \zeta_i^*(0)\xi_i = \xi^*$ and $u^*(\hat{\mu}) \in S_l$. Then the following holds:

PROPOSITION 2.11 *Let the assumptions of Theorem 2.3 hold. Then there is a C^k -smooth hyper-surface $(\omega_{\text{ext}}(\mu_{\text{ext}}, \nu), \mu(\mu_{\text{ext}}, \nu))$ of relative periodic orbits $u(\mu_{\text{ext}}, \nu)$ in the $(\omega_{\text{ext}}, \mu)$ -parameter-space with $\nu \in \mathbb{R}^d$, $d = p - (m - n)$ and $|\nu|$ small, satisfying*

$$\Phi_{2\pi/\omega_{\text{ext}}(\mu_{\text{ext}}, \nu), 0}(u(\mu_{\text{ext}}, \nu); \mu(\mu_{\text{ext}}, \nu)) = \rho_{\tilde{g}(\chi(\mu_{\text{ext}}, \nu))} u(\mu_{\text{ext}}, \nu)$$

and

$$u(\mu_{\text{ext}}, \nu) \in S_l, \quad u(0, 0) = u^*, \quad \chi(0, 0) = 0,$$

provided that the $(m - n, p)$ -matrix

$$(\partial_{(\omega_{\text{ext}}, \hat{\mu})} T_{\text{ext}} \zeta_i^*(0))_{i=n+1,\dots,m}$$

has full rank.

PROOF. We solve the equation

$$\tilde{g}(\chi)^{-1}g(\omega_{\text{ext}}, \mu) = \text{id}$$

by the implicit function theorem. \blacksquare

In the examples 2.6, 2.8, 2.9 above the hyper-surface $g = \tilde{g}(\chi)$ consists of elements with average drift velocity far away from the drift velocity ξ^* of the relative equilibrium.

2.3 SCALING OF DRIFT VELOCITY

In this section we study the scaling of drifts induced by a *harmonic* periodic forcing where the forcing term in (2.1) is of the form

$$f_{\text{ext}}(u, \omega_{\text{ext}}t, \mu) = \tilde{f}(u) \cos(\omega_{\text{ext}}t, \mu). \quad (2.11)$$

Such a forcing term is usually used in experiments [16], [35]. Further let $\mu = \mu_{\text{ext}} \in \mathbb{R}$.

We first state a general proposition, then we apply this result to some examples in spiral wave dynamics explaining scaling laws which were observed in experiments or simulations. In the end we give a mathematical definition of the spiral tip. The motion of the spiral tip is measured in experiments to visualize the drift [5].

We assume that the unforced system (2.1) has a non-critical relative equilibrium u^* and denote again by $\{\xi_1, \xi_2, \dots, \xi_m\}$ a basis of $\text{alg}(G)$.

PROPOSITION 2.12 *Assume that the periodic forcing term in (2.1) is of the form (2.11). Fix a forcing frequency ω_{ext}^* . Let $u(\mu_{\text{ext}})$, $g(\mu_{\text{ext}})$ be relative periodic orbits for $\mu_{\text{ext}} \approx 0$. Write*

$$g(\mu_{\text{ext}}) = e^{T_{\text{ext}}\zeta(\mu_{\text{ext}})}e^{T_{\text{ext}}\xi^*}, \quad \zeta(\mu_{\text{ext}}) = \sum_{i=1}^m \zeta_i(\mu_{\text{ext}})\xi_i.$$

Assume that the geometric multiplicity of the eigenvalue 0 of the linear map $[\cdot, \xi^]$ on $\text{alg}(G)$ equals its algebraic multiplicity. Then*

$$\partial_{\mu_{\text{ext}}}\zeta_i(0) = 0 \quad \text{if} \quad [\xi_i, \xi^*] = 0.$$

This is also true if f_{ext} is not a harmonic periodic forcing, but the mean value $\int_0^{2\pi} f_{\text{ext}}(u, t)dt$ of f_{ext} is zero.

Now assume that the periodic forcing is resonant so that the linear map $[\cdot, \xi^]$ on $\text{alg}(G)$ has eigenvalues $\pm i\omega_G^*$ with eigenvectors $\xi_1 \pm i\xi_2$ such that $\omega_G^*/\omega_{\text{ext}}^* = j \in \mathbb{Z}$. Assume that the algebraic and the geometric multiplicity of the eigenvalue $\pm i\omega_G^*$ of $[\cdot, \xi^*]$ are equal. Then*

$$\partial_{\mu_{\text{ext}}}\zeta_i(0) = 0 \quad \text{for} \quad i = 1, 2 \quad \text{if} \quad j > 1.$$

If u^* is a rotating wave then $e^{T_{\text{ext}}\xi^*} = \text{id}$ for some T_{ext} . Therefore the (m, m) -matrix $[\cdot, \xi^*]$ is semisimple and has eigenvalues $\pm i\omega_G^*$ with $\omega_G^*/\omega_{\text{ext}}^* = j \in \mathbb{Z}$ and the above proposition can be applied, see Example 2.13 below.

PROOF OF PROPOSITION 2.12. We write a prime for $\partial_{\mu_{\text{ext}}}$ in the following calculation. We choose the functionals l_i in (2.5) defining the section transversal to the group orbit again as left center-eigenvectors of L^* . Differentiating (2.5) with respect to μ_{ext} in $\mu_{\text{ext}} = 0$ gives

$$\sum_{i=1}^m T_{\text{ext}}^* \zeta'_i(0) \xi_i u^* = (e^{T_{\text{ext}} L^*} - 1) u'(0) + \rho_{\exp(-T_{\text{ext}} \xi^*)} \partial_{\mu} \Phi_{T_{\text{ext}}^*}(u^*; \mu)|_{\mu=0} \tag{2.12}$$

where

$$\rho_{\exp(-\xi^* T_{\text{ext}})} \partial_{\mu_{\text{ext}}} \Phi_{T_{\text{ext}}}(u^*; \mu)|_{\mu=0} = \int_0^{2\pi/\omega_{\text{ext}}} e^{L^*(2\pi/\omega_{\text{ext}}-t)} \tilde{f}(u^*) \cos(\omega_{\text{ext}} t) dt.$$

Let P be the spectral projection of L^* to the eigenvalue 0. Since algebraic and geometric multiplicity of the eigenvalue 0 of $[\xi^*, \cdot]$ are equal by assumption and the relative equilibrium u^* is noncritical we conclude that $PL^* = 0$ and therefore

$$\int_0^{2\pi/\omega_{\text{ext}}} P e^{L^*(2\pi/\omega_{\text{ext}}-t)} \tilde{f}(u^*) \cos(\omega_{\text{ext}} t) dt = 0.$$

Applying P onto (2.12) we therefore get

$$\sum_{i=1}^m T_{\text{ext}}^* \zeta'_i(0) P \xi_i u^* = \int_0^{2\pi/\omega_{\text{ext}}} P e^{L^*(2\pi/\omega_{\text{ext}}-t)} \tilde{f}(u^*) \cos(\omega_{\text{ext}} t) dt = 0.$$

This proves that $\zeta'_i(0) = 0$ if $[\xi_i, \xi^*] = 0$, and we see that we get the same result if only the time average of $f_{\text{ext}}(u, t, 0)$ is zero.

Now let Q be the spectral projection to the eigenvalue $i\omega_G^*$, $\omega_G^*/\omega_{\text{ext}}^* = j$. Applying Q onto (2.12) we get, similarly as above,

$$\sum_{i=1}^m T_{\text{ext}}^* \zeta'_i(0) Q \xi_i u^* = \int_0^{2\pi/\omega_{\text{ext}}} Q e^{L^*(2\pi/\omega_{\text{ext}}-t)} \tilde{f}(u^*) \cos(\omega_{\text{ext}} t) dt.$$

As above we conclude that $\zeta'_i(0) = 0$ for $i = 1, 2$ if $j > 1$. ■

EXAMPLE 2.13 Again let $G = \text{E}(2)$ and let u^* be a non-critical rotating wave of the unforced system (2.1), e.g. a rigidly rotating spiral wave of the reaction-diffusion system (2.2) on the plane $\Omega = \mathbb{R}^2$. Assume that the periodic forcing is resonant $\omega_{\text{rot}}^* = j\omega_{\text{ext}}^*$, $j \in \mathbb{Z}$. Then according to Example 2.6 there is a path $u(\mu_{\text{ext}})$, $a(\mu_{\text{ext}})$, $\omega_{\text{ext}}(\mu_{\text{ext}})$ of modulated travelling waves (drifting spiral waves of the reaction-diffusion system (2.2)) in the parameter-plane $(\omega_{\text{ext}}, \mu_{\text{ext}}) \in \mathbb{R}^2$. Assume that the periodic forcing is harmonic. By Proposition 2.12 the drift velocity $v(\mu_{\text{ext}}) = \frac{a(\mu_{\text{ext}})}{T_{\text{ext}}}$ of the modulated travelling waves satisfies $v'(0) = 0$ if $|j| > 1$.

Drift velocities which only grow with the square μ_{ext}^2 of the amplitude of the external periodic forcing are rather small and apparently difficult to find in experiments. That is why in experiments [35] mainly the 1:1-resonance is observed; however in [16] also a 2 : 1-resonance could be detected experimentally.

EXAMPLE 2.14 Let $G = \text{SO}(3)$ and let u^* be a non-critical wave of the unforced system (2.1) rotating around the x_1 -axis with speed ω_{rot}^* , for instance, a rigidly rotating spiral wave in the reaction-diffusion system (2.2) on the sphere, see Example 2.8; if the periodic forcing is resonant $\omega_{\text{rot}}^* = j\omega_{\text{ext}}^*$, $j \in \mathbb{Z}$ then according to Example 2.8 there is a path $u(\mu_{\text{ext}})$, $\phi(\mu_{\text{ext}})$, $\omega_{\text{ext}}(\mu_{\text{ext}})$ of modulated rotating waves meandering around some vector in the (x_2, x_3) -plane. By Proposition 2.12 their drift velocity $\omega_{\text{rot}}(\mu_{\text{ext}}) = \phi(\mu_{\text{ext}})/T_{\text{ext}}(\mu_{\text{ext}})$ satisfies $\omega'_{\text{rot}}(0) = 0$ if $j > 1$.

EXAMPLE 2.15 We again consider a twisted scroll ring, see Example 2.9. In this case the symmetry group is $G = \text{E}(2) \times \mathbb{R}$ and the drift velocity of the scroll ring is given by $\xi^* = (\omega_{\text{rot}}^*, v^* \mathbf{e}_1)$. Denote by $u(\mu_{\text{ext}})$, $g(\mu_{\text{ext}})$ the relative periodic orbits generated by periodic forcing of the twisted scroll with fixed forcing frequency ω_{ext} . We write $g(\mu_{\text{ext}}) = (\phi(\mu_{\text{ext}}), a(\mu_{\text{ext}}))$ where $a(\mu_{\text{ext}}) \in \mathbb{R}^3$, $a(0) = a^* \mathbf{e}_1 = T_{\text{ext}} v^* \mathbf{e}_1$, $\omega_{\text{rot}}(\mu_{\text{ext}}) = \phi(\mu_{\text{ext}})/T_{\text{ext}}$, $\omega_{\text{rot}}(0) = \omega_{\text{rot}}^*$. By Proposition 2.12 we have

$$|\omega_{\text{rot}}(\mu_{\text{ext}}) - \omega_{\text{rot}}^*| = O(\mu_{\text{ext}}^2), \quad |a_1(\mu_{\text{ext}}) - a^*| = O(\mu_{\text{ext}}^2),$$

but in general $|a_i(\mu_{\text{ext}})| = O(\mu_{\text{ext}})$, $i = 2, 3$. This is also observed in numerical simulations, see [15].

Now we define the *tip position* $x_{\text{tip}}(u)$ for $u \in Y$. It is not clear at all how to define the spiral tip exactly. Experimentalists often determine the tip of a spiral wave in two dimensions visually as point with maximal curvature at the end of the spiral [5], but there are also other more or less precise definitions around [14].

From a symmetry point of view the position $x_{\text{tip}}(u) \in \mathbb{R}^2$ of the spiral tip in the case $G = \text{E}(2)$ is a function of the spiral wave solution u into \mathbb{R}^2 and has the following property.

DEFINITION 2.16 *The tip position $x_{\text{tip}}(\cdot)$ is a C^1 -smooth G -equivariant function which maps an open set of Y into a G -manifold M .*

For example in the case $G = \text{E}(2)$ we choose $\pi(\phi, a) = a$, $\pi(G) = \mathbb{R}^2$ and G acts on $\pi(G)$ by the natural affine representation [8]; in the case $G = \text{SO}(3)$ we choose $\pi(G) = S^2$; each $g \in \text{SO}(3)$ can be represented by a vector $\phi \in \mathfrak{so}(3) = \mathbb{R}^3$ such that $g = \exp(\phi)$ is a rotation around the unit vector $\phi/|\phi|$ by the rotation angle $|\phi|$; we set $\pi(\exp(\phi)) = \phi/|\phi|$.

In experiments the drift phenomena we talked about are detected by following the spiral tip $x_{\text{tip}}(u)$. For the spiral tip $x_{\text{tip}}(u(\omega_{\text{ext}}, \mu_{\text{ext}}))$ the same scaling phenomena hold as for the drifts $g(\omega_{\text{ext}}, \mu_{\text{ext}})$.

2.4 RESONANT PERIODIC FORCING OF RELATIVE PERIODIC ORBITS

Now we consider resonant periodic forcing of relative periodic orbits. We still assume that the isotropy K of the relative periodic orbit is trivial, otherwise we choose $G = N(K)/K$, $Y = \text{Fix}(K)$ as before.

Experiments on periodic forcing of meandering spiral waves have been carried out e.g. by Müller and Zykov [35]. Here invariant 3-tori were found and frequency locking between the period of the relative periodic orbits and the period of the external forcing was observed. Furthermore for certain periods of the external forcing modulated travelling waves were found in experiments. This phenomenon is called "generalized resonance drift" [35].

We will only consider frequency locked relative periodic solutions generated by external periodic forcing. Let again $T_{\text{ext}} = \frac{2\pi}{\omega_{\text{ext}}}$ denote the period of the forcing, let μ_{ext} denote its amplitude and let T^* be the period of the relative periodic orbit for $\mu = 0$. Assume that u^* is a non-critical relative periodic orbit in $\mu = 0$, that is, u^* satisfies $\Phi_{T^*}(u^*) = \rho_{g^*}u^*$, for some $T^* > 0$, $B^* = \rho_{g^*}^{-1}D\Phi_{T^*}(u^*)$ satisfies Hypothesis (S) and the center-eigenspace only consists of eigenvectors forced by G -symmetry or time-shift symmetry:

$$E_c = \text{alg}(G)u^* \oplus \text{span}(\partial_t \Phi_t(u^*)|_{t=0}).$$

Furthermore suppose that

$$T_{\text{new}} = jT_{\text{ext}} = \ell T^* \quad \text{where } \text{gcd}(j, \ell) = 1.$$

Let P_θ be the spectral projection corresponding to the center spectral set of $\rho_{g^*}^{-1}D\Phi_1(\Phi_\theta(u^*))$. The condition $P_\theta(u - \Phi_\theta(u^*)) = 0$ defines a section S_θ transversal to the relative periodic orbit in $\Phi_\theta(u^*)$.

PROPOSITION 2.17 *Under the above conditions there is a C^k -smooth hypersurface $u(\theta, \mu)$ of $\ell : j$ -frequency-locked relative periodic solutions with $\mu \in \mathbb{R}^p$, $\theta \in [0, T^*]$, satisfying*

$$\Phi_{\frac{2\pi j}{\omega_{\text{ext}}(\theta, \mu)}, 0}(u(\theta, \mu)) = \rho_{g(\theta, \mu)}u(\theta, \mu), \quad u(\theta, \mu) \in S_\theta, \quad (2.13)$$

and $u(\theta, 0) = \Phi_\theta(u^*)$, $g(\theta, 0) = (g^*)^\ell$.

This proposition is proved similarly as Theorem 2.3. We refer to section 4 for a proof.

Assume for a moment that G is compact. Due to periodic forcing it may happen that a discrete rotating wave, i.e., a relative periodic orbit u^* for which g^* lies in a discrete Cartan subgroup Z_n , starts drifting. If $\text{gcd}(n, \ell) > 1$, then $(g^*)^\ell$ may lie in a Cartan subgroup $Z_{n/\text{gcd}(n, \ell)} \times T^N$, $N > 0$ and $\ell : j$ -frequency locked relative periodic orbits nearby starts drifting.

An example is the group $G = \text{O}(2)$ where g^* is a reflection. If $\ell = 2$ then modulated rotating waves with relative period $T_{\text{new}} \approx 2T^*$ are generated by the resonant periodic forcing of the discrete rotating wave u^* . Such a phenomenon can not occur in the case of relative equilibria.

Another phenomenon that may occur in the case of periodic forcing is resonance drift as we saw in the preceding sections. Let ξ^* be a drift velocity of g^* . By resonance drift we mean that there are group elements g close to $(g^*)^\ell$ with all average drift velocities ξ far away from the drift velocity ξ^* of g^* . We first give an example. Then we state a general proposition.

EXAMPLE 2.18 We consider periodic forcing of meandering spiral waves. In this case the symmetry group is $G = E(2)$, and

$$u^* = \rho_{(-\phi^*, 0)} \Phi_{T^*}(u^*)$$

is a modulated rotating wave. Assume that

$$\ell\phi^* = 0 \pmod{2\pi}, \quad \ell \neq 0,$$

and that $\hat{\mu} \in \mathbb{R}$ ($p = 2$). If $\partial_{\hat{\mu}}\phi^*(0) \neq 0$ then there is an $\ell : j$ -frequency locked modulated travelling wave $u(\theta, \mu_{\text{ext}})$ to the parameter $\mu = (\mu_{\text{ext}}, \hat{\mu}(\theta, \mu_{\text{ext}}))$, $\omega_{\text{ext}}(\theta, \mu_{\text{ext}})$ such that $u(\theta, 0) = u^*$. Here $\phi^*(\hat{\mu})$ is the rotation angle for the modulated rotating wave $u^*(\hat{\mu}) = \rho_{(-\phi^*(\hat{\mu}), 0)} \Phi_{T^*(\hat{\mu})}(u^*(\hat{\mu}))$ for the autonomous system ($\mu_{\text{ext}} = 0$) with parameter $\hat{\mu}$. This explains the "generalized drift resonance" of locked solutions reported by [35].

Let $g = \tilde{g}(\chi)$ as in section 2.1 be a hyper-surface of dimension n in G such that $g(0) = (g^*)^\ell$ and that (2.8), (2.9), (2.10) hold. The hyper-surface $g = \tilde{g}(\chi)$ may for example consist of the group elements with average velocities far away from the drift velocity ξ^* of g^* .

Let $u^*(\hat{\mu}) = \rho_{\exp(\sum_{i=1}^m \zeta_i^*(\hat{\mu}) T^*(\hat{\mu}) \xi_i) g^*} \Phi_{T^*(\hat{\mu})}(u^*(\hat{\mu}))$, $P_0(u^*(\hat{\mu}) - u^*) = 0$, be relative periodic orbits of the unforced system (2.1) where $\mu_{\text{ext}} = 0$ such that $u^*(0) = u^*$, $T^*(0) = T^*$, $\zeta_i(0) = 0$, $i = 1, \dots, m$. Similarly as in Proposition 2.11 we find:

PROPOSITION 2.19 Under the above assumptions there is a C^k -smooth hyper-surface of $\ell : j$ -frequency locked relative periodic orbits near u^* satisfying

$$\Phi_{\frac{j2\pi}{\omega_{\text{ext}}(\theta, \mu_{\text{ext}}, \nu)}, 0}(u(\theta, \mu_{\text{ext}}, \nu); \mu(\theta, \mu_{\text{ext}}, \nu)) = \rho_{\tilde{g}(\chi(\theta, \mu_{\text{ext}}, \nu))} u(\theta, \mu_{\text{ext}}, \nu),$$

and $u(\theta, \mu_{\text{ext}}, \nu) \in S_\theta$, where $\nu \in \mathbb{R}^d$, $d = p - 1 - (n - \dim(G))$, $|\nu|$ small, provided that the $(n - \dim(G), p - 1)$ -matrix

$$(\partial_{\hat{\mu}} \zeta_i^*(0))_{i=n+1, \dots, \dim(G)}$$

has full rank.

Now we study the scaling behaviour of the drift velocities in the case of harmonic periodic forcing (2.11) which is usually used in experiments [35]. Let $\mu = \mu_{\text{ext}} \in \mathbb{R}$.

PROPOSITION 2.20 *Let the periodic forcing be harmonic as in (2.11). Fix a frequency ω_{ext} of the periodic forcing and write the pull-back elements $g(\theta, \mu_{\text{ext}})$ of the $\ell : j$ -frequency locked periodic orbits, see Proposition 2.17, as*

$$g(\theta, \mu_{\text{ext}}) = \exp\left(\sum_{i=1}^m jT_{\text{ext}}(\theta, \mu_{\text{ext}})\zeta_i(\theta, \mu_{\text{ext}})\xi_i\right)(g^*)^\ell.$$

If $\ell > 1$ and if the geometric multiplicity of the eigenvalue 1 of Ad_{g^} equals its algebraic multiplicity then we have:*

$$\partial_{\mu_{\text{ext}}}\zeta_i(0) = 0 \quad \text{for all } i \text{ with } \text{Ad}_{g^*}\xi_i = \xi_i.$$

Moreover the Arnold tongues where the frequency locking occurs grow as $|\mu_{\text{ext}}|^2$ if $\ell > 1$.

Note that if $(g^*)^\ell = \text{id}$ as in Example 2.18 the matrix Ad_{g^*} is semisimple so that Proposition 2.20 can be applied.

Again a cautious note: in the case $G = \text{E}(2)$ the meandering spiral wave can not start drifting unboundedly if its spatial symmetry group K contains a nontrivial rotation. In general by periodic forcing the isotropy group of the relative periodic orbit is not changed. So the group element $g(\theta, \mu)$ satisfying $\Phi_{jT_{\text{ext}}(\theta, \mu)}(u(\theta, \mu)) = \rho_{g(\theta, \mu)}u(\theta, \mu)$ is in $N(K)$ where K is the isotropy of u^* for properly chosen $u(\theta, \mu)$. Note that we chose $G = N(K)/K$ in the whole section.

PROOF OF PROPOSITION 2.20. Let $W(t, 0) = \text{D}\Phi_t(u^*)$ denote the solution of the variation equation along $\Phi_t(u^*)$ and let $W(t, s) := W(t, 0)(W(s, 0))^{-1}$, that is, $W(t, s) = \text{D}\Phi_{t-s}(\Phi_s(u_*))$. We have

$$\begin{aligned} \partial_{\mu_{\text{ext}}}\Phi_{T_{\text{new}}}(u^*, 0) &= \int_0^{\ell T^*} W(\ell T^*, s)\tilde{f}(\Phi_s(u^*))\cos\left(\frac{2\pi js}{\ell T^*}\right)ds \\ &= \int_0^{T^*} (\dots)ds + \dots + \int_{(\ell-1)T^*}^{\ell T^*} (\dots)ds \\ &= \text{Re}\left(C \int_0^{T^*} W(T^*, s)\tilde{f}(\Phi_s(u^*))e^{\frac{2\pi ijs}{\ell T^*}} ds\right) \end{aligned}$$

where

$$C = \rho_{g^*}^\ell \sum_{i=0}^{\ell-1} (\rho_{g^*}^{-1}W(T^*, 0))^{\ell-i-1} e^{2\pi iji/\ell} \rho_{g^*}^{-1}.$$

Here we used that

$$\begin{aligned} W(t + iT^*, s + iT^*) &= \text{D}\Phi_{t-s}(\Phi_{s+iT^*}(u_*)) = \text{D}\Phi_{t-s}(\rho_{g^*}^i\Phi_s(u_*)) \\ &= \rho_{g^*}^i W(t, s)\rho_{g^*}^{-i} \end{aligned}$$

and that

$$\begin{aligned} W(\ell T^*, iT^*) &= D\Phi_{(\ell-i)T^*}(\Phi_{iT^*}(u^*)) = \rho_{g^*}^i D\Phi_{(\ell-i)T^*}(u^*)\rho_{g^*}^{-i} \\ &= \rho_{g^*}^\ell \rho_{g^*}^{i-\ell} D\Phi_{(\ell-i)T^*}(u^*)\rho_{g^*}^{-i} \\ &= \rho_{g^*}^\ell (\rho_{g^*}^{-1}W(T^*, 0))^{\ell-i} \rho_{g^*}^{-i}, \end{aligned}$$

and that therefore for $s \in [0, T^*)$

$$\begin{aligned} W(\ell T^*, s + iT^*) &\tilde{f}(\Phi_{iT^*+s}(u^*)) \\ &= W(\ell T^*, (i+1)T^*)W(iT^* + T^*, iT^* + s)\rho_{g^*}^i \tilde{f}(\Phi_s(u^*)) \\ &= \rho_{g^*}^\ell (B^*)^{\ell-i-1} \rho_{g^*}^{-1} W(T^*, s) \tilde{f}(\Phi_s(u^*)), \end{aligned}$$

where $B^* := \rho_{g^*}^{-1}W(T^*, 0)$.

Let P be the spectral projection of B^* to the eigenvalue 1. We have

$$P\rho_{g^*}^{-\ell} \partial_{\mu_{\text{ext}}} \Phi_{T_{\text{new}}}(u^*, 0) = \text{Re} \left(cP\rho_{g^*}^{-1} \int_0^{T^*} W(T^*, s) \tilde{f}(\Phi_s(u^*)) e^{\frac{2\pi ijs}{\ell T^*}} ds \right) \quad (2.14)$$

where $c = \sum_{i=0}^{\ell-1} e^{2\pi iji/\ell}$. So $P\partial_{\mu_{\text{ext}}} \Phi_{T_{\text{new}}}(u^*; 0) = 0$ if $\ell > 1$.

Differentiating (2.13) in the solution $(u, g, \omega_{\text{ext}})(\mu)$ with respect to μ_{ext} in $\mu = 0$ yields with $g(\theta, \mu_{\text{ext}})(g^*)^{-\ell} = \exp(\sum_{i=1}^m jT_{\text{ext}}(\theta, \mu_{\text{ext}})\zeta_i(\theta, \mu_{\text{ext}})\xi_i)$

$$\begin{aligned} 0 &= ((B^*)^\ell - 1)\partial_{\mu_{\text{ext}}} u(\theta, \mu_{\text{ext}})|_{\theta, \mu_{\text{ext}}=0} - \ell T^* \sum_{i=1}^m \partial_{\mu_{\text{ext}}} \zeta_i(0)\xi_i u^* \\ &\quad - \frac{2\pi j \partial_{\mu_{\text{ext}}} \omega_{\text{ext}}(0)}{\omega_{\text{ext}}^2(0)} \partial_t \Phi_t(u^*)|_{t=0} + \rho_{g^*}^{-\ell} \partial_{\mu_{\text{ext}}} \Phi_{T_{\text{new},0}}(u^*, \mu)|_{\mu=0}. \end{aligned}$$

Applying the projection P to the eigenvalue 1 of B^* we see that $\frac{\partial \zeta_i}{\partial \mu_{\text{ext}}}(0) = 0$ for all i with $\text{Ad}_{g^*} \xi_i = \xi_i$ and that $\frac{\partial \omega_{\text{ext}}}{\partial \mu_{\text{ext}}}(0) = 0$ provided that $\ell > 1$. ■

3 HOPF BIFURCATION FROM RELATIVE EQUILIBRIA

In this section we study transitions from relative equilibria to relative periodic orbits in autonomous systems caused by Hopf bifurcation. For experiments on Hopf bifurcation from rotating waves – the meandering transition – in the Belousov-Zhabotinsky reaction see [26], [32], [27]. First we state a general theorem for Hopf bifurcation from relative equilibria. The proof of the Hopf theorem can be found in Subsection 4.6. In Subsection 3.2 we explain the drift phenomena caused by resonance which were observed in experiments. In Subsection 3.3 we discuss equivariant Hopf bifurcation.

In the whole section we assume that the nonlinearity f in (1.3) is autonomous. So we consider the differential equation

$$\frac{du}{dt} = -Au + f(u, \mu). \quad (3.1)$$

In the applications we have in mind (3.1) is an autonomous reaction-diffusion system

$$\frac{\partial u_i}{\partial t} = \delta_i \Delta u_i + f_i(u, \mu), \quad i = 1, \dots, M, \quad (3.2)$$

cf. (1.1).

3.1 THE THEOREM ON HOPF BIFURCATION

Let u^* be a relative equilibrium of (3.1) for $\mu = 0$ satisfying Hypothesis (S). We will show in Section 4 below that Hypothesis (S) implies that $\rho_g u^*$ is C^k in g . In this subsection we assume that the isotropy K of the relative equilibrium is trivial $K = \{\text{id}\}$ or we exchange G by $N(K)$, Y by $\text{Fix}(K)$. We assume that $\pm i$ are eigenvalues of the linearization $L^* = -A - \xi^* + Df(u^*)$ in the comoving frame which are not only caused by symmetry, i.e., if Q is the spectral projection of L^* to the i then there is some $w \in QY$ with $w \notin \text{alg}(G)u^*$. Furthermore assume that

$$ni \in \text{spec}(L^*), n \in \mathbb{Z} \implies QY \subset \text{span}(w, \bar{w}) \oplus \text{alg}(G)u^*.$$

Let $u^*(\mu)$ be the C^k -smooth path of relative equilibria with

$$\Phi_t(u^*(\mu)) = \rho_{\exp(t\xi^*(\mu))} u^*(\mu), \quad l_i(u^*(\mu) - u^*) = 0, \quad i = 1, \dots, m, \quad u(0) = u^*.$$

Note that we can obtain the path of relative equilibria $u^*(\mu)$ near u^* by applying Theorem 2.3 with non-resonant period T_{ext} . As before the functionals l_i , $i = 1, \dots, m$, determine a section $S_l = u^* + \hat{S}_l$ transversal to the group orbit of the relative equilibrium u^* . We choose the functionals l_i such that $l_i(w) = 0$, $i = 1, \dots, m$ (e.g. by using the spectral projection of L^* to the symmetry eigenvalues to construct the functionals l_i).

LEMMA 3.1 *Under the above assumptions there is a C^{k-1} -path $\beta(\mu)$ of eigenvalues of the linearization*

$$L^*(\mu) = -A + Df(u^*(\mu)) - \xi^*(\mu)$$

such that $\beta(0) = i$.

This lemma will be proved in section 4.6 below.

We write $\mu = (\mu_1, \mu_2)$ where $\mu_1 \in \mathbb{R}$ and $\mu_2 \in \mathbb{R}^{p-1}$. If the transversality condition

$$\text{Re} \frac{\partial \beta(0)}{\partial \mu_1} \neq 0 \quad (3.3)$$

holds then we can assume w.l.o.g. that $\mu_1 = 0$ parametrizes the relative equilibria $u^*(\mu)$ which are Hopf points.

THEOREM 3.2 *Under the above assumptions there are relative periodic orbits $u(s, \mu_2)$, $s \in \mathbb{R}_0^+$ small, of relative period $T(s, \mu_2)$ near u^* to the parameter $\mu_1(s)$ satisfying*

$$\Phi_{T(s)}(u(s, \mu_2), (\mu_1(s), \mu_2)) = \rho_{g(s, \mu_2)} u(s, \mu_2) \quad (3.4)$$

and $u(0) = u^*$, $\mu(0) = 0$, $g(0) = e^{2\pi\xi^*}$, $T(0) = 2\pi$ provided that the transversality condition (3.3) is satisfied. For each small s a circle $u_l(s_1, s_2, \mu_2)$, $s_1 = s \cos \tau$, $s_2 = s \sin \tau$, $\tau \in [0, 2\pi]$, of the relative periodic orbit to the parameter s lies in the section S_l with corresponding pull-back element $g_l(s_1, s_2, \mu_2)$, and we fix the phase by setting $u(s, \mu_2) = u_l(s, 0, \mu_2)$, $g(s, \mu_2) = g_l(s, 0, \mu_2)$, such that $\partial_s u(0) = \operatorname{Re} w$. The functions $u_l(s_1, s_2, \mu_2)$, $\mu_1(s, \mu_2)$, $g_l(s_1, s_2, \mu_2)$, $T(s, \mu_2)$ are C^{k-1} in $s_1, s_2 \in \mathbb{R}$ and $\mu_2 \in \mathbb{R}^{p-1}$, and $\mu_1(s, \mu_2)$ and $T(s, \mu_2)$ only depend on $s = \|(s_1, s_2)\|$ and μ_2 .

Theorem 3.2 is proved in section 4.6 below. The Hopf bifurcation from relative equilibria to relative periodic orbits is called relative Hopf bifurcation because it is a Hopf bifurcation in the space of group orbits. Formally we can define a semiflow $\Psi_t(\cdot)$ on \hat{S}_l in a comoving frame by

$$\Psi_t(u; \mu) = \rho_{g(\Phi_t(u, \mu))}^{-1} \Phi_t(u + u^*(\mu); \mu) - u^*(\mu) \quad (3.5)$$

where $g(u)$ is such that $l_i(\rho_{g(u)}^{-1}u - u^*) = 0$, $i = 1, \dots, m$, ie. $\rho_{g(u)}^{-1}u \in S_l$. Under the above assumptions $\Psi_t(\cdot)$ undergoes a usual Hopf bifurcation with two simple Hopf eigenvalues $\pm i$ and without any resonances. To see this note that the linearization $e^{\tilde{L}t}$ of $\Psi_t(u)$ in the Hopf point $u = 0$ is given by $\tilde{L} = P_l L^* P_l$ where P_l is the projection onto the space $l_i(u) = 0$, $i = 1, \dots, m$ such that $P_l \operatorname{alg}(G)u^* = 0$. Choosing l_i , $i = 1, \dots, m$, such that $l_i(\rho_g y)$ is C^1 in g for $y \in Y$ (which is possible as we will see in Lemma 4.3 below) we see that the semiflow $\Psi_t(u)$ is strongly continuous on Y . But it is only smooth in u if the group action is smooth on $\Phi_t(u)$, $t > 0$, $u \in Y$, which is not the case in applications as we saw in the introduction, cf. subsection 1.5.

Often we need not use the full symmetry G of (3.1) to prove the Hopf theorem. The situation is analogous to the case of periodic forcing of relative equilibria, see section 2.1: If L^* does not have eigenvalues ij , $j \in \mathbb{Z}$, forced by symmetry then $\xi^* = 0$ and we have an ordinary Hopf bifurcation from an equilibrium. If $[\xi^*, \cdot]$ has eigenvalues in $i\mathbb{Z}$, then the corresponding (generalized) eigenvectors form a Lie subalgebra of $\operatorname{alg}(G)$. We call the group generated by this Lie subalgebra the minimal symmetry group for the Hopf bifurcation.

EXAMPLE 3.3 Consider again the reaction-diffusion system (3.2) on the domain $\Omega = \mathbb{R}^2$. Then the symmetry group is $G = E(2)$. Let u^* be a rigidly rotating spiral wave $\Phi_t(u^*) = \rho_{(\omega_{\text{rot}}^* t, 0)} u^*$ of the reaction-diffusion system (3.2). The meandering transition mentioned in the introduction corresponds to a relative Hopf bifurcation from the rotating wave u^* .

3.2 RESONANCE DRIFT AND SCALING OF DRIFT VELOCITY

In this section we deal with resonant Hopf bifurcation. Again we assume that the isotropy K of the relative equilibrium u^* is trivial, $K = \{\text{id}\}$ or we choose Y as $\text{Fix}(K)$, G as $N(K)/K$. In the next subsection we will deal with equivariant Hopf bifurcation where $K \neq \{\text{id}\}$. Let the assumptions of Theorem 3.2 hold, let again u^* be a Hopf point with Hopf eigenvalues $\pm i$, let again $\mu \in \mathbb{R}^p$ and let $u^*(\mu)$ be relative equilibria satisfying $l_i(u^*(\mu) - u^*) = 0$, $i = 1, \dots, m$, and

$$\Phi_t(u^*(\mu)) = \rho_{\exp(\xi^*(\mu)t)} u^*(\mu), \quad \xi^*(\mu) = \sum_{i=1}^m \zeta_i^*(\mu) \xi_i,$$

with $u^*(0) = u^*$, $\xi^*(0) = \xi^*$. Here we again denote by $\{\xi_i; i = 1, \dots, m\}$ a basis of the Lie algebra $\text{alg}(G)$ of G . We have

$$L^* \xi u^* = [\xi, \xi^*] u^*, \quad e^{2\pi L^*} \xi u^* = \text{Ad}_{\exp(-2\pi \xi^*)} \xi u^* = (e^{2\pi[\cdot, \xi^*]}) \xi u^*, \quad \xi \in \text{alg}(G).$$

If $\exp(\cdot)$ is not locally surjective near $2\pi \xi^*$ then there may be relative periodic orbits bifurcating from the relative equilibrium with all average drift velocities completely different from the drift velocity ξ^* of the relative equilibrium at the Hopf bifurcation. We talk of resonance drift as introduced in subsection 2.2.

For resonance drift to occur it is necessary that the Hopf bifurcation is resonant which means that the linearization L^* of the relative equilibrium in the comoving frame has a symmetry eigenvalue in $i\mathbb{Z} \setminus \{0\}$. In group-theoretical terms, the linear map $[\cdot, \xi^*]$ has eigenvalues in $i\mathbb{Z} \setminus \{0\}$. Otherwise $\exp(\cdot)$ would be surjective near $2\pi \xi^*$ and the relative periodic orbits $u(s)$ generated by Hopf bifurcation would drift with velocity $\xi(s) \approx \xi^*$, cf. subsection 2.2.

Let $g = \tilde{g}(\chi)$ be an n -dimensional hyper-surface in G , $\chi \in \mathbb{R}^n$, $|\chi| \leq 1$ such that $\tilde{g}(0) = g^* = e^{\xi^* 2\pi}$. Write $\tilde{g}(\chi) = \exp(\tilde{\zeta}(\chi)) g^*$ where $\tilde{\zeta} = \sum_{i=1}^{\dim(G)} \tilde{\zeta}_i(\chi) \xi_i$, $\tilde{\zeta}_i(0) = 0$, $i = 1, \dots, \dim(G)$, and assume that (2.9) and (2.10) hold. As in section 2.2 the hyper-surface $g = \tilde{g}(\chi)$ may consist of elements with average drift velocity far away from the drift velocity ξ^* of the relative equilibrium. Again let $\mu = (\mu_1, \mu_2)$ with $\mu_1 \in \mathbb{R}$, $\mu_2 \in \mathbb{R}^{p-1}$.

PROPOSITION 3.4 *Let the assumptions of Theorem 3.2 and the above assumptions hold and let $K = \{\text{id}\}$. If $\frac{\partial}{\partial \mu_1} \text{Re} \beta(0) \neq 0$ and if the matrix*

$$\partial_{\mu_2} \left(\frac{\text{Im} \beta(\mu)}{\zeta_i^*(\mu)} \right) \Big|_{\mu=0} \}_{i=n+1, \dots, m} \tag{3.6}$$

has full rank then there are relative periodic orbits with average drift inside the hypersurface $g = \tilde{g}(\chi)$, more precisely: there are C^{k-1} -smooth functions $u(s, \nu)$, $T(s, \nu)$, $\mu(s, \nu)$, $\chi(s, \nu)$ such that

$$\Phi_{T(s, \nu)}(u(s, \nu)) = \rho_{\tilde{g}(\chi(s, \nu))} u(s, \nu).$$

Here $\nu \in \mathbb{R}^d$, $d = p - 1 - (\dim(G) - n)$, $\chi(0) = 0$, $u(0) = u^$.*

PROOF. By Theorem 3.2 there are relative periodic orbits $u(s, \mu_2)$, $g(s, \mu_2)$, $T(s, \mu_2)$ bifurcating from $u^*(\mu)|_{\mu_1=0}$. We want to solve the equation $\tilde{g}(\chi)^{-1}g(s, \mu_2) = \text{id}$ by the implicit function theorem. Since $T(0, \mu_2) = \frac{2\pi}{\text{Im}\beta(0, \mu_2)}$ we have

$$\begin{aligned} \partial_{\mu_2}g(0, \mu_2)|_{\mu_2=0} &= \partial_{\mu_2} \exp\left(\sum_{i=1}^m \frac{2\pi\zeta_i^*(0, \mu_2)}{\text{Im}\beta(0, \mu_2)}\xi_i\right)|_{\mu_2=0} \\ &= 2\pi\left(\sum_{i=1}^m \partial_{\mu_2}\zeta_i^*(0)\xi_i - \text{Im}\partial_{\mu_2}\beta(0)\xi^*\right)g^*. \end{aligned}$$

We need that $\partial_{(\chi, \mu_2)}\tilde{g}(\chi)^{-1}g(s, \mu_2)|_{(s, \chi, \mu_2)=(0, 0, 0)}$ has full rank. Therefore the matrix

$$\{\partial_{\mu_2}\zeta_i^*(0) - \zeta_i^*(0)\partial_{\mu_2}\text{Im}\beta(0)\}_{i=n+1, \dots, \dim(G)}$$

has to be invertible, that is, we need that

$$\left\{\partial_{\mu_2}\left(\frac{\text{Im}\beta(\mu)}{\zeta_i^*(\mu)}\right)\Big|_{\mu=0}\right\}_{i=n+1, \dots, \dim(G)}$$

has full rank. ■

Now we study the scaling behaviour of the drift velocities. Let $\mu \in \mathbb{R}$ and write the pull-back elements $g(s)$ of the bifurcating relative periodic orbits $u(s)$ as

$$g(s) = \exp(T(s)\zeta(s))g^*, \quad \zeta(s) = \sum_{i=1}^{\dim(G)} \zeta_i(s)\xi_i. \quad (3.7)$$

REMARK 3.5 *Let $[\xi_i, \xi^*] = 0$. Then $\frac{d}{ds}\zeta_i(0) = 0$. In a $j : 1$ -resonance*

$$[\xi_1 + i\xi_2, \xi^*] = ij(\xi_1 + i\xi_2), \quad j \in \mathbb{N},$$

we have $\frac{d^\ell}{ds^\ell}\zeta_i(0) = 0$, $i = 1, 2$, $\ell = 1, \dots, \min(j, k) - 1$.

PROOF. Differentiating

$$\rho_{g(s)}^{-1}\Phi_{T(s)}(u(s); \mu(s)) - u(s) = 0$$

w.r.t. s in $s = 0$ gives

$$-2\pi \sum_{i=1}^m \zeta_i'(0)\xi_i u^* + (e^{2\pi L^*} - 1)\text{Re}w = 0.$$

Applying the spectral projection P_0 of L^* to the eigenvalue 0 gives

$$P_0 \sum_{i=1}^m \zeta_i'(0)\xi_i u^* = 0.$$

If $[\xi_i, \xi^*] = 0$ then $P_0 \xi_i u^* = \xi_i u^*$, so $\zeta'_i(0) = 0$. We have

$$\Phi_{T(s)}(u_l(s_1, s_2), \mu(s)) = \rho_{g_l(s_1, s_2)} u_l(s_1, s_2) \quad (3.8)$$

where $s_1 = s \cos \tau$, $s_2 = s \sin \tau$, $\tau \in [0, 2\pi]$. By Theorem 3.2 $u_l(s_1, s_2)$ and $g_l(s_1, s_2)$ are C^{k-1} -smooth in s_1, s_2 . We write $g_l(s_1, s_2)$ as in (3.7):

$$g_l(s_1, s_2) = \exp(T(s)\zeta_l(s_1, s_2))g^*, \quad \zeta_l(s_1, s_2) = \sum_{i=1}^{\dim(G)} \zeta_{l,i}(s_1, s_2)\xi_i.$$

Since $u_l(s_1, s_2) \in G\Phi_{\tau T(s)/2\pi}(u(s), \mu(s))$ there are C^{k-1} -functions $\hat{g}(\tau, s) \in G$, $\hat{\zeta}(\tau, s) \in \text{alg}(G)$ such that $\hat{g}(\tau, 0) = \text{id}$, $\hat{\zeta}(\tau, 0) = 0$,

$$\hat{g}(\tau, s) = \exp(\hat{\zeta}(\tau, s)), \quad \hat{\zeta}(\tau, s) = \sum_{i=1}^m \hat{\zeta}_i(\tau, s)\xi_i$$

and

$$u_l(s_1, s_2) = \rho_{\hat{g}(\tau, s) \exp(-\xi^* \tau T(s)/2\pi)} \Phi_{\tau T(s)/2\pi}(u(s), \mu(s)). \quad (3.9)$$

From (3.4), (3.8), (3.9) we conclude that

$$g_l(s_1, s_2) = \hat{g}(\tau, s) \exp\left(-\frac{\tau T(s)}{2\pi} \xi^*\right) g(s) \exp\left(\frac{\tau T(s)}{2\pi} \xi^*\right) \hat{g}(\tau, s)^{-1}.$$

Hence

$$e^{T(s)\zeta(s_1, s_2)} = e^{\hat{\zeta}(\tau, s)} \exp(T(s) \text{Ad}_{\exp(-\frac{\tau T(s)}{2\pi} \xi^*)} \zeta(s)) e^{-\text{Ad}_{g^*} \hat{\zeta}(\tau, s)}.$$

We can choose G minimal such that $\text{Ad}_{g^*} = \text{id}$ on $\text{alg}(G)$. Therefore we conclude that for each i

$$\zeta_{l,i}(s_1, s_2)\xi_i = \text{Ad}_{\exp(\hat{\zeta}(\tau, s)) \exp(\frac{\tau T(s)}{2\pi} \xi^*)} \zeta_i(s)\xi_i.$$

Since $\exp(\xi^* \tau)(\xi_1 + i\xi_2) = \exp(ij\tau)(\xi_1 + i\xi_2)$ we see that

$$\zeta_{l,1}(s_1, s_2)\xi_1 + i\zeta_{l,2}(s_1, s_2)\xi_2 = (1 + sM(s)) \exp(ij\tau)(\zeta_1(s)\xi_1 + i\zeta_2(s)\xi_2)$$

where $M(s) \in \text{Mat}(2)$ is a C^{k-2} smooth function. Therefore since $\zeta_{l,i}(s_1, s_2)$, $i = 1, 2$, is C^{k-1} -smooth in s_1, s_2 we conclude that $\frac{d^\ell}{ds^\ell} \zeta_i(0) = 0$, $\ell = 0, \dots, \min(j, k) - 1$, $i = 1, 2$. ■

EXAMPLE 3.6 Again let $G = \text{E}(2)$ and let u^* be a rotating wave $\Phi_t(u^*) = \rho_{(\omega_{\text{rot}}^* t, 0)} u^*$ of (3.1), e.g. a rigidly rotating spiral wave of (3.2). Assume that the parameter space is two-dimensional, $\mu \in \mathbb{R}^2$, as in Fig. 3, and that parameters are chosen such that the rotating waves $u^*(\mu)$ which are Hopf points lie on the line $\mu_1 = 0$ in parameter space. Note that $\pm i\omega_{\text{rot}}^*$ are eigenvalues of $[\cdot, \xi^*]$ with eigenvectors $\xi_2 \pm i\xi_3$, cf. Example 2.1. Choosing the hypersurface $g = \tilde{g}(\chi)$ in

Proposition 3.4 as the subgroup of translations we now understand Fig. 3: If the rotation frequency ω_{rot}^* is resonant to the Hopf frequency $\omega_{\text{Hopf}}^* = 1$, $\omega_{\text{rot}}^* = j\omega_{\text{Hopf}}^* \in \mathbb{Z}$ and the resonance is crossed with nonzero speed $\partial_{\mu_2}(\frac{\text{Im}\beta(\mu)}{\omega_{\text{rot}}^*(\mu)})|_{\mu=0} \neq 0$ (which is generically satisfied) then there is a path $\mu(s)$ in parameter space \mathbb{R}^2 of modulated travelling waves (drifting spiral waves)

$$\Phi_{T(s)}(u(s); \mu(s)) = \rho_{(0,a(s))}u(s).$$

From Remark 3.5 we see that the drift velocity $v(s) = |a(s)|/T(s)$ generically scales like $|\mu|^{j/2}$, see [4], [8].

3.3 EQUIVARIANT RELATIVE HOPF BIFURCATION

In this subsection we study relative Hopf bifurcation in the case of a compact isotropy $K \neq \{\text{id}\}$ of the relative equilibrium u^* . We consider the case when the spatial isotropy K of the relative equilibrium is broken. If the bifurcating solutions are relative periodic solutions and not relative equilibria we talk of equivariant or symmetry-breaking relative Hopf bifurcation.

Assume that the linearization L^* at the relative equilibrium u^* has an eigenvalue i with a generalized eigenvector $w \notin \text{alg}(G)u^*$, i.e., the eigenvalue i of L^* is not (only) caused by symmetry. The generalized eigenspace to the Hopf eigenvalues $\pm i$ is K -invariant and may be forced by K -equivariance of L^* to have higher dimension than two even if $\pm i$ are not eigenvalues of $[\cdot, \xi^*]$. see [11]. Let again $S_l = u^* + \hat{S}_l$ denote a section transversal to the group orbit Gu^* at u^* defined by functionals l_i , $i = 1, \dots, m_K$ where $m_K = \dim(G/K)$ and denote by P_l the projection from Y to the subspace $\hat{S}_l = \{y; l_i(y) = 0, i = 1, \dots, m_K\}$. Since K is compact we can choose P_l to be K -equivariant and $P_l Y = \hat{S}_l$ to be K -invariant: for example choose $P = P_s + Q$ where P_s is the projection onto the stable eigenspace of L^* and Q is an orthogonal projection from the finite-dimensional center-unstable eigenspace E_{cu} to $(\text{alg}(G)u^*)^\perp$. Since ξ^* commutes with the elements of K the operator $L^* = -A + Df(u^*) - \xi^*$ is K -equivariant and therefore E_{cu} is invariant and P_s is K -equivariant. If we choose the scalar-product on E_{cu} to be K -invariant then also Q is K -equivariant. Define $\tilde{L} = P_l L P_l$. Denote the eigenspace of \tilde{L} to the eigenvalues $\pm i$ by V . In the generic case when i is a simple eigenvalue of \tilde{L} the matrices $e^{\tilde{L}\tau}$, $\tau \in [0, 2\pi]$, define an S^1 -action on V .

We consider the subgroups H of $K \times S^1$ with two-dimensional fixed point spaces. They are called axial subgroups [11]. Let $\pi : K \times S^1 \rightarrow K$ be the projection of $K \times S^1$ onto its first component. For each axial subgroup H there is a homomorphism $\Theta : K \rightarrow S^1 = \mathbb{R}/\mathbb{Z}$ such that $H = \{(h, \Theta(h)) \mid h \in \pi(H)\}$, see [11], [7]. There are two cases, $\Theta(K) = S^1$ or $\Theta(K) = Z_\ell$. Let K_{bif} denote the kernel of Θ . Then the following lemma holds:

LEMMA 3.7 *Let the assumptions of Theorem 3.2 and the above assumptions hold. If $\Theta(K) = S^1$ then there is a symmetry breaking transition from relative equilibria to relative equilibria.*

If $\Theta(K) = Z_\ell$ then a symmetry breaking relative Hopf bifurcation takes place: Let $h^* = \Theta^{-1}(1/\ell) \in K$. There is a path of relative periodic solutions $u(s)$ which emanates from the relative equilibrium u^* by equivariant relative Hopf bifurcation and satisfies

$$\Phi_{T(s)/\ell}(u(s)) = \rho_{g(s)h^*}u(s), \quad T(0) = 2\pi, u(0) = u^*, g(0) = e^{2\pi\xi^*/\ell}.$$

The isotropy of the bifurcating solutions is $K_{\text{bif}} = \ker(\Theta)$ in both cases.

The proof is a small modification of the proof of Theorem 3.2 and can be found in subsection 4.6, see also [7]. Again the pull-back element $g(s)h^*$ of the relative periodic orbit $u(s)$ has to lie in $N(K_{\text{bif}})$. In the following discussion assume that $G = N(K_{\text{bif}})/K_{\text{bif}}$.

In the case of symmetry breaking Hopf bifurcation the average velocity of the bifurcating relative periodic orbits is often far away from the drift velocity of the relative equilibrium, as we see from the following example.

EXAMPLE 3.8 (See also [7], [10]) Again let $G = E(2)$ and let u^* be a rotating wave $\Phi_t(u^*) = \rho_{(\omega_{\text{rot}}^*t, 0)}u^*$ with isotropy $K = Z_\ell$, for example a rigidly rotating spiral wave of (3.2) with ℓ identical arms. Consider a representation of K on the critical eigenspace $V = \text{span}_{\mathbb{C}}(w, \bar{w})$ which is faithful, i.e., $\Theta^{-1}(1/\ell) = 2\pi n/\ell$, $\text{gcd}(\ell, n) = 1$. If the rotating wave is a Hopf point then under the usual transversality condition and in the non-resonant case a Hopf bifurcation to modulated rotating waves takes place. The average rotation frequency $\omega_{\text{rot}}(s)$ of the bifurcating modulated rotating waves is given as $\omega_{\text{rot}}(s) = (h^* + \phi(s))/(T(s)/\ell)$. Note that $h^* = 2\pi n/\ell$ and that $g(s) = (\phi(s), a(s))$ satisfies $g(0) = (\omega_{\text{rot}}^* 2\pi/\ell, 0)$. Hence we get

$$\omega_{\text{rot}}(s=0) = (2\pi n/\ell + \omega_{\text{rot}}^* 2\pi/\ell)/(2\pi/\ell) = n + \omega_{\text{rot}}^*.$$

But in physical space the bifurcating modulated rotating waves in Example 3.8 still seem to drift in a similar direction as the rotating wave u^* . So what is a useful definition of resonance drift in the case of symmetry-breaking Hopf bifurcation? We first continue our example:

EXAMPLE 3.9 (Example 3.8 continued) We recall the condition for noncompact drift of relative periodic orbits nearby the Hopf point in Example 3.8, see also [7], [10]. Since $g(s) \in N(K_{\text{bif}})$ we can only get noncompact drift if $K_{\text{bif}} \subseteq K$ is trivial. So we consider again, as above, a faithful representation of K on the critical eigenspace $V = \text{span}_{\mathbb{C}}(w, \bar{w})$, where $\Theta^{-1}(1/\ell) = 2\pi n/\ell$, $\text{gcd}(\ell, n) = 1$. Resonance drift occurs if $\omega_{\text{rot}}^* = j\ell - n$, $j \in \mathbb{Z}$, since for noncompact drift $\phi(0) = 2\pi\omega_{\text{rot}}^*/\ell + 2\pi n/\ell = 0 \pmod{2\pi}$ has to be satisfied. Since $i\omega_{\text{rot}}^*$ is in the spectrum of $[\cdot, \xi^*]$ with eigenvectors $\xi_1 + i\xi_2$ we see from Remark 3.5 that the drift velocity $v(s) = |a(s)|/T(s)$ generically grows as $|\mu|^{j\ell - n}/2$.

In the case of noncompact drift in the above example we clearly want to speak of resonance drift. Since we do not want to care about the (small) effects of the

broken spatial Z_ℓ symmetry of the bifurcating relative periodic orbits in the comoving system (3.5) we only talk of resonance whenever the drift $(g(s)h^*)^\ell$ of the relative periodic orbits after time $T(s)$ is not of the form $\exp(2\pi\xi)$ with $\xi \approx \xi^*$. Note that a necessary condition for resonance drift is that $\exp(\cdot)$ is not locally surjective at $\xi = 2\pi\xi^*$, but since $g(s)$ and h^* need not commute (in contrast to h^* and ξ^*) this condition is not sufficient: in Example 3.6 where the isotropy is trivial the condition for unbounded drift is $\omega_{\text{rot}}^* \in \mathbb{Z}$, in the case of Z_ℓ -isotropy the condition for noncompact drift is more restrictive, see Example 3.9.

4 PROOF OF THE MAIN THEOREMS

This section is devoted to the proof of the theorems on periodic forcing and Hopf bifurcation which we presented in Sections 2 and 3. First, in subsections 4.1 – 4.4 we present a general method how to continue relative periodic orbits that satisfy the spectral hypothesis (S). In subsection 4.5 we prove Theorem 2.3 on periodic forcing. In subsection 4.6 below we use the developed methods to prove the Hopf theorem 3.2 by use of Lyapunov-Schmidt reduction.

4.1 THE METHOD OF PROOF

Assume that we are given a relative periodic orbit $u^* = \rho_{g^*}^{-1} \Phi_{2\pi/\omega_{\text{ext}}^*, 0}(u^*)$ of (2.1) that satisfies the spectral hypothesis (S). We want to continue this relative periodic orbit wrt. the parameters μ and ω_{ext} , i.e., we want to solve the equation $F = 0$ where F is given by

$$F(u, g, \omega_{\text{ext}}, \mu) = \begin{pmatrix} \rho_g^{-1} \Phi_{T_{\text{ext}}, 0}(u; \omega_{\text{ext}}, \mu) - u \\ l_i(u - u^*), \quad i = 1, \dots, m \end{pmatrix}. \quad (4.1)$$

We consider (4.1) for u in the fixed point space $\text{Fix}(K)$ where K is the isotropy of the relative periodic orbit. W.l.o.g. we assume that $Y = \text{Fix}(K)$ and $G = N(K)$ is the normalizer of K . The functionals l_i , $i = 1, \dots, m$, define a section transversal to the group orbit Gu^* at u^* . We will show in Lemma 4.5 below that hypothesis (S) implies that $\rho_g u^*$ is C^1 in g so that it makes sense to talk about a transverse section to Gu^* . We can not solve (4.1) by the ordinary implicit function theorem because in general $F(u, g, \omega_{\text{ext}}, \mu)$ is only continuous in g . This comes from the fact that the G -action is only strongly continuous and the Lie algebra elements $\xi \in \text{alg}(G)$ act in general as unbounded operators on Y . Furthermore, the time-evolution does not smoothen the group action, that is, $\rho_g \Phi_{T_{\text{ext}}, 0}(u)$ is not differentiable in g in general. This is due to the fact that the operators $\xi \in \text{alg}(G)$ are not assumed to be bounded w.r.t. A (in the case of the reaction-diffusion system (1.1) the operator $\frac{\partial}{\partial \phi}$ is not bounded w.r.t. Δ , see Proposition 1.2). Therefore the operator $\frac{\partial F}{\partial u}(u, g, \omega_{\text{ext}}, \mu)$ is in general not continuous in g with respect to the norm $\|\cdot\|_{\mathcal{L}(Y)}$. We overcome these difficulties as follows:

We will solve the fixed point equation

$$y = \Pi(y, q, g, \omega_{\text{ext}}, \mu) = (1 - \hat{P})\rho_g^{-1}\Phi_{T_{\text{ext}},0}(y + q; \omega_{\text{ext}}, \mu), \quad (4.2)$$

$y \in (1 - \hat{P})Y$, $q \in \hat{P}Y$, by Banach's contraction mapping theorem. Here \hat{P} is a projector which is near the projection P onto the center-unstable eigenspace E_{cu} of $B^* = \rho_g^{-1}D\Phi_{T_{\text{ext}},0}(u^*)$ in the $\mathcal{L}(Y)$ -norm. Furthermore we will show that the solution $y(q, g, \omega_{\text{ext}}, \mu)$ of this fixed point equation depends smoothly on the parameters $(q, g, \omega_{\text{ext}}, \mu)$ and that the G -action on the solutions is smooth. Then we solve the reduced equation $F_{\text{red}} = 0$

$$F_{\text{red}}(q, g, \omega_{\text{ext}}, \mu) = \begin{pmatrix} \hat{P}\rho_g^{-1}\Phi_{T_{\text{ext}},0}(y(q, g, \omega_{\text{ext}}, \mu) + q; \omega_{\text{ext}}, \mu) - q \\ l_i(y(q, g, \omega_{\text{ext}}, \mu) + q - u^*) = 0, \quad i = 1, \dots, m \end{pmatrix} \quad (4.3)$$

by the implicit function theorem. In this way we can solve (4.1).

4.2 THE SCALE OF BANACH SPACES $\{Y_j\}_{j=0,\dots,k}$

For $j > 1$, define inductively

$$Y_j := \{u \in Y_{j-1}; \xi u \in Y_{j-1} \text{ for any } \xi \in \text{alg}(G)\}, \quad Y_0 = Y, \quad (4.4)$$

equipped with the graph norm $|\cdot|_{Y_j}$ given by

$$|u|_{Y_j} = |u|_{Y_{j-1}} + \sup_{\xi \in \text{alg}(G), |\xi|=1} |\xi u|_{Y_{j-1}}.$$

Let Y^* be the dual space to Y and define

$$Z_0^* := \{y^* \in Y^*; \rho_g^* y^* \text{ is } C^0 \text{ in } g\},$$

where ρ_g^* denotes the adjoint operator of ρ_g in Y^* . For $j > 1$, we define the spaces Z_j^* with norm $|\cdot|_{Z_j^*}$ for the adjoint group action as in (4.4) with Y_0 replaced by Z_0^* .

In the following we will often use that $P\rho_g$ and $\rho_g P$ are continuous in g with respect to the norm $\|\cdot\|_{\mathcal{L}(Y)}$. For the second operator this is clear since ρ_g is strongly continuous in g and PY is finite-dimensional. The operator $P\rho_g$ is continuous in g with respect to the norm $\|\cdot\|_{\mathcal{L}(Y)}$ iff $\rho_g^* P^*$ is continuous with respect to the norm $\|\cdot\|_{\mathcal{L}(Y^*)}$ where P^* is the spectral projection in Y^* onto the left center-unstable eigenspace of L^* .

LEMMA 4.1 P^* maps Y^* into Z_0^* .

If the group G acts strongly continuously on the dual space, for example in the case $G = \text{E}(2)$ acting on $Y = L^2(\mathbb{R}^2, \mathbb{R}^M)$, then Lemma 4.1 is automatically satisfied. Therefore we will skip the proof which is elementary, but technical and can be found in [23, Lemmata 5.1,5.2].

REMARK 4.2 *If we replace the assumption of a C^0 -action of G by the assumption that $\rho_g u^*$ is continuous in g and the group action is weakly continuous then the theorems in sections 2, 3 still hold.*

This is due to the fact that $PY \subset Y_0$ is still satisfied, see [23, Lemmata 5.1,5.2] and we can therefore restrict the problem onto Y_0 .

Since $\xi\Phi_{t,t_0}(u) = D\Phi_{t,t_0}(u)\xi u$ we see that Φ_{t,t_0} maps Y_1 into Y_1 . Inductively we see that the time-evolution Φ_{t,t_0} maps each Y_j , $j \leq k$, into itself. Further Φ_{t,t_0} is C^{k-j} -smooth from Y_j into Y_j .

Now we need the following lemma:

LEMMA 4.3 *Y_1 is dense in Y_0 and Z_1^* is dense in Z_0^* . Moreover, G acts as C^0 -group on Y_j , Z_j^* .*

The proof can be found in [23, Lemma 4.1]. If $\dim(G) = 1$ this is usual semigroup theory. From this lemma we can deduce

LEMMA 4.4 *There is a projector \hat{P} near P such that $\rho_g \hat{P}$ and $\hat{P} \rho_g$ are C^k in g .*

This was shown in [23, Lemma 5.3]. The idea is the following: let e_i , $i = 1, \dots, \dim(PY)$ be a basis of PY , and e_i^* , $i = 1, \dots, \dim(PY)$, be a basis for P^*Y . Then by the foregoing lemma we can find $\hat{e}_i \in Y_k$, $\hat{e}_i^* \in Z_k^*$ which are near e_i resp. e_i^* in the Y -norm resp. Y^* -norm. From these vectors \hat{e}_i , \hat{e}_i^* we "build" the projection \hat{P} .

4.3 REGULARITY OF THE RELATIVE PERIODIC ORBIT

Now we need the following main lemma which will inductively yield C^k -regularity of Gu^* and $\rho_g P$, $P\rho_g$:

LEMMA 4.5 *If Hypothesis (S) is satisfied then $u^* \in Y_1$.*

PROOF. For a proof involving exponential dichotomies see [23]. Here we will give a more elementary proof.

In a first step we define a formal expression for ξu^* , $\xi \in \text{alg } G$, and in a second step we will show that ξu^* exists and indeed equals this expression.

Let \hat{P} be a projector near P such that $\rho_g \hat{P}$ and $\hat{P} \rho_g$ are C^1 in g in the operator norm on Y and denote $\Phi = \Phi_{T_{\text{ext}},0}$. Since $u^* = \rho_{g^*}^{-1} \Phi(u^*)$ and $\xi \rho_g^{-1} = \rho_g^{-1} \text{Ad}_g \xi$ we have

$$\xi u^* = \rho_{g^*}^{-1}(\text{Ad}_{g^*} \xi) \Phi(u^*) = \rho_{g^*}^{-1} D\Phi(u^*)(\text{Ad}_{g^*} \xi) u^* = B^*(\text{Ad}_{g^*} \xi) u^*$$

where $B^* = \rho_{g^*}^{-1} D\Phi(u^*)$ and so we formally get

$$z(\xi) = B_s z(\text{Ad}_{g^*} \xi) + \eta(\xi). \quad (4.5)$$

Here

$$z(\xi) := (1 - \hat{P})\xi u^*, \quad B_s := (1 - \hat{P})B^*, \quad \eta(\xi) = B_s \hat{P}(\text{Ad}_{g^*} \xi) u^*.$$

Note that $z(\xi)$ and $\eta(\xi)$ are linear in ξ . Since \hat{P} is near P and since the spectral radius of $(1 - P)B^*$ is smaller than one also the spectral radius of B_s is smaller than one. Let $\{\xi_i, i = 1, \dots, m\}$ be a basis of $\text{alg}(G)$. By our overall hypothesis the operator $\text{Ad}_{g^*} : \text{alg}(G) \rightarrow \text{alg}(G)$ has spectrum on the unit circle. Let $(\text{Ad}_{g^*})_{ij}$ be the matrix associated to the operator Ad_{g^*} with respect to the basis $\{\xi_i, i = 1, \dots, m\}$ of $\text{alg}(G)$. We can define Ad_{g^*} as operator in $Y^m = Y \times \dots \times Y$ by setting

$$\text{Ad}_{g^*}(z_1, \dots, z_m) := (s_1, \dots, s_m), \quad s_i = \sum_{j=1}^m (\text{Ad}_{g^*})_{ij} z_j, \quad z_i \in Y, \quad i = 1, \dots, m.$$

Also the operator B_s can be extended to an operator on Y^m by defining

$$B_s(z_1, \dots, z_m) := (B_s z_1, \dots, B_s z_m), \quad z_i \in Y, \quad i = 1, \dots, m.$$

Hence the operator $B_s \text{Ad}_{g^*} = \text{Ad}_{g^*} B_s$ on Y^m has also spectral radius smaller than one. Changing $\Phi = \Phi_{T_{\text{ext}}, 0}$ to $\Phi_{\ell T_{\text{ext}}, 0}$ and accordingly B^* to $(B^*)^\ell$ and g^* to $(g^*)^\ell$ with ℓ large enough we can achieve that $\|B_s\| \|\text{Ad}_{g^*}\| < 1$. W.l.o.g. we assume that $\ell = 1$. We rewrite (4.5) as

$$(1 - B_s \text{Ad}_{g^*})z = \eta, \quad z = (z_1, \dots, z_m), \quad \eta = (\eta_1, \dots, \eta_m) \quad (4.6)$$

where $\eta_i = \eta(\xi_i)$, $i = 1, \dots, m$, are well-defined since $\hat{P}\rho_g$ is C^1 in g in the operator norm. The system of equations (4.6) can be solved uniquely for $z_i = z(\xi_i)$, $i = 1, \dots, m$. So we have proved that $\xi_i u^* = z_i + \hat{P}\xi_i u^*$ formally exists for all ξ_i , $i = 1, \dots, m$, and hence by linear combination we get for each $\xi \in \text{alg}(G)$ a formal expression $z(\xi) + \hat{P}\xi u^*$ which we know equals ξu^* if $u^* \in Y_1$.

To show that the formal expression $z(\xi)$ is indeed $(1 - \hat{P})\xi u^*$ we argue as follows. Let $z(\xi, t) = \frac{1}{t}(1 - \hat{P})(\rho_{\exp(\xi t)} u^* - u^*)$. We have

$$\begin{aligned} z(\xi, t) &= \frac{1}{t}(1 - \hat{P})(\rho_{\exp(\xi t)} \rho_{g^*}^{-1} \Phi(u^*) - \rho_{g^*}^{-1} \Phi(u^*)) \\ &= B_s(t)z(\text{Ad}_{g^*} \xi, t) + \eta(\xi, t) \end{aligned} \quad (4.7)$$

where

$$B_s(t) := (1 - \hat{P})\rho_{g^*}^{-1} D\Phi(u^* + \Theta(t)(\rho_{\exp(\text{Ad}_{g^*} \xi t)} u^* - u^*))$$

with $0 \leq \Theta(t) \leq 1$ and

$$\eta(\xi, t) = \frac{1}{t} B_s(t) \hat{P}(\rho_{\exp(\text{Ad}_{g^*} \xi t)} u^* - u^*).$$

Here we applied the mean value theorem. Let $\delta_z(\xi, t) = z(\xi, t) - z(\xi)$. Then

$$\delta_z(\xi, t) = B_s(t)\delta_z(\text{Ad}_{g^*} \xi, t) + \delta_\eta(\xi, t) \quad (4.8)$$

where

$$\delta_\eta(\xi, t) = (B_s(t) - B_s)z(\xi) + \eta(\xi, t) - \eta(\xi)$$

converges to zero as $t \rightarrow 0$. Let

$$\epsilon_z(t) = \sup_{\|\xi\| \leq 1, |\tau| \leq t} \delta_z(\xi, \tau), \quad \epsilon_\eta(t) = \sup_{\|\xi\| \leq 1, |\tau| \leq t} \delta_\eta(\xi, \tau).$$

Here $\|\xi\| = (\sum_{i=1}^m \zeta_i^2)^{1/2}$ for $\xi = \sum_{i=1}^m \zeta_i \xi_i$ is a norm on $\text{alg } G$. We define $B_s(t)$ like B_s as operator from Y^m into Y^m . Since $B_s(t)$ is continuous in t in the $\mathcal{L}(Y)$ -norm and $\|B_s\| \| \text{Ad}_{g^*} \| < 1$ we get $\|B_s(t)\| \| \text{Ad}_{g^*} \| = c < 1$ for t small enough.

From (4.8) we get

$$\epsilon_z(t) \leq c\epsilon_z(\| \text{Ad}_{g^*} \|t) + \epsilon_\eta(t) \quad (4.9)$$

with $\epsilon_\eta(t) \rightarrow 0$ as $t \rightarrow 0$. Here we used that

$$\begin{aligned} z(\text{Ad}_{g^*}\xi, t) &= z\left(\frac{1}{\| \text{Ad}_{g^*} \|} \text{Ad}_{g^*}\xi, \| \text{Ad}_{g^*} \|t\right) \| \text{Ad}_{g^*} \|, \\ z(\text{Ad}_{g^*}\xi) &= z\left(\frac{1}{\| \text{Ad}_{g^*} \|} \text{Ad}_{g^*}\xi\right) \| \text{Ad}_{g^*} \| \end{aligned}$$

and that therefore

$$\delta_z(\text{Ad}_{g^*}\xi, t) = \delta_z\left(\frac{1}{\| \text{Ad}_{g^*} \|} \text{Ad}_{g^*}\xi, \| \text{Ad}_{g^*} \|t\right) \| \text{Ad}_{g^*} \|^2$$

and consequently

$$\sup_{\|\xi\| \leq 1} \delta_z(\text{Ad}_{g^*}\xi, t) \leq \| \text{Ad}_{g^*} \|^2 \sup_{\|\xi\| \leq 1} \delta_z(\xi, \| \text{Ad}_{g^*} \|t).$$

From (4.9) we conclude that

$$\epsilon_z(t) \leq c^\ell \epsilon_z(\| \text{Ad}_{g^*} \|^{\ell} t) + \sum_{i=0}^{\ell-1} c^i \epsilon_\eta(\| \text{Ad}_{g^*} \|^i t),$$

and hence that

$$\epsilon_z(t/\| \text{Ad}_{g^*} \|^{\ell}) \leq \frac{1 - c^\ell}{1 - c} \epsilon_\eta(t) + c^\ell \epsilon_z(t).$$

Choosing t small enough and ℓ large enough we see that $\epsilon_z(t) \rightarrow 0$ as $t \rightarrow 0$. ■

4.4 CONTRACTIONS ON A SCALE OF BANACH SPACES

We first show (Lemma 4.6) that Π^ℓ is a contraction in $(1 - \hat{P})Y$ for some $\ell \in \mathbb{N}$. Afterwards, in Lemma 4.7, we show that we can apply the contraction theorem on the Banach scale $\{(1 - \hat{P})Y_j\}_{j=0, \dots, k-1}$. Finally Theorem 4.8 below guarantees that the solution we obtained depends smoothly on parameters.

LEMMA 4.6 *Let u^* be a relative periodic orbit of (1.3) to the parameters $(\omega_{\text{ext}}^*, \mu^*)$ fulfilling the spectral condition (S). Let \hat{P} be a projection which is $\mathcal{L}(Y)$ -near P . Let $(g, \omega_{\text{ext}}, \mu)$ be near $(g^*, \omega_{\text{ext}}^*, \mu^*)$ and let $(y + q)$ be near $(y^* + q^*)$ in the Y -norm with $y^*, y \in (1 - \hat{P})Y$, $q, q^* \in \hat{P}Y$, $q^* + y^* = u^*$. Then Π satisfies*

$$\left\| \frac{\partial \Pi^\ell}{\partial y}(y, q, g, \omega_{\text{ext}}, \mu) \right\| \leq c < 1,$$

where $\ell \in \mathbb{N}$ is sufficiently large.

PROOF OF LEMMA 4.6. Again let $B^* = \rho_{g^*}^{-1} D\Phi_{T_{\text{ext}}, 0}(u^*)$. We have $\|(B^*(1 - P))^\ell\| \leq MC^\ell$, $C < 1$. Let $\ell \in \mathbb{N}$ be so large that for g in a neighborhood U_G of id in G

$$\|(1 - P)\rho_g(B^*)^\ell(1 - P)\| \leq \|(1 - P)\|M_G C^\ell M < 1.$$

Here we used that for $g \in U_G$ there is a uniform bound M_G of $\|\rho_g\|$. Then $(1 - P)\rho_g(B^*)^\ell(1 - P)$ is a uniform contraction for $g \in U_G$. We have

$$D_y \Pi^\ell(y) = \prod_{i=0}^{\ell-1} D\Pi(\Pi^i(y)) = \prod_{i=0}^{\ell-1} (1 - \hat{P})\rho_g^{-1} D_z \Phi_{T_{\text{ext}}, 0}(q + z)|_{z=\Pi^i(y)}.$$

Since y is near y^* , q is near q^* and g is near g^* we know that $\Pi^i(y) \approx y^*$ and that

$$\rho_g^{-1} D_u \Phi_{T_{\text{ext}}, 0}(u)|_{u=q+\Pi^i(y)} \approx \rho_g^{-1} \rho_{g^*} B^*$$

in the operator norm. Since \hat{P} is near P in the $\|\cdot\|_{\mathcal{L}(Y)}$ -norm we conclude that

$$D_y \Pi^\ell(y) \approx \prod_{i=0}^{\ell-1} (1 - P)\rho_{g^{-1}g^*} B^*(1 - P)$$

in the norm on $\mathcal{L}(Y)$. Further we compute

$$\begin{aligned} (\rho_{g^{-1}g^*} B^*)^2 &= \rho_{g^{-1}} D_y \Phi_{T_{\text{ext}}, 0}(u^*) \rho_{g^{-1}g^*} B^* \approx \rho_{g^{-1}} \rho_{g^{-1}g^*} D_y \Phi_{T_{\text{ext}}, 0}(u^*) B^* \\ &= \rho_{g^{-2}(g^*)^2} (B^*)^2. \end{aligned}$$

Similarly we get

$$(\rho_{g^{-1}g^*} B^*)^\ell \approx \rho_{g^{-\ell}(g^*)^\ell} (B^*)^\ell.$$

Since $\rho_g P$ and $P \rho_g$ are continuous in g in the operator norm we conclude that $D_y \Pi^\ell(y)$ is near $(1 - P)\rho_{g^{-\ell}(g^*)^\ell} (B^*)^\ell (1 - P)$ for g near g^* , y near y^* , q near q^* in the operator norm. Hence $\frac{\partial \Pi^\ell}{\partial y}(y, q, g, \omega_{\text{ext}}, \mu)$ is a contraction if we choose $(y + q, g, \omega_{\text{ext}}, \mu)$ near $(y^* + q^*, g^*, \omega_{\text{ext}}^*, \mu^*)$ (here we measure $y - y^*$, $q - q^*$ in the Y -norm). ■

Now we show that Π^ℓ is a contraction on the scale of Banach spaces $\{(1 - \hat{P})Y_j\}_{j=0, \dots, k-1}$ for some $\ell = \ell(k) \in \mathbb{N}$.

LEMMA 4.7 *Let u^* be a relative periodic orbit of (1.3) to the parameters $(\omega_{\text{ext}}^*, \mu^*)$ fulfilling Hypothesis (S). If f is C^k -smooth, $k \in \mathbb{N}$, then we have:*

- (i) $u^* \in Y_k$.
- (ii) $B^* Y_j \subseteq Y_j$, $(B^*)^* Z_j^* \subseteq Z_j^*$, and $\text{spec}(B_j^*) \subset \text{spec}(B^*)$, $j = 1, \dots, k-1$, where B_j^* is the operator B^* considered as map from Y_j into itself. Further, $P \in \mathcal{L}(Y, Y_{k-1})$, $P^* \in \mathcal{L}(Y^*, Z_{k-1}^*)$.
- (iii) u^* satisfies Hypothesis (S) on each Y_j , $0 \leq j \leq k-1$.
- (iv) Let \hat{P} be $\mathcal{L}(Y, Y_{k-1})$ -near P . If $\ell = \ell(k) \in \mathbb{N}$ is large enough then the function $y \rightarrow \Pi^\ell(y, q, g, \omega_{\text{ext}}, \mu)$ from (4.2) is a uniform contraction on each Y_j , $0 \leq j \leq k-1$, for $y+q$ Y_j -near u^* and $(g, \omega_{\text{ext}}, \mu)$ near $(g^*, \omega_{\text{ext}}^*, \mu^*)$.
- (v) Let \hat{P} be as in (iv) and assume that $\rho_g \hat{P}$ and $\hat{P} \rho_g$ are C^k -smooth in the $\mathcal{L}(Y)$ -norm. Then there is a locally unique solution $y(q, g, \omega_{\text{ext}}, \mu) \in (1 - \hat{P})Y$ of (4.2) which is continuous in $(q, g, \omega_{\text{ext}}, \mu)$ with respect to the norm $\|\cdot\|_{Y_k}$.

Part (i) of this lemma can also be found in [23].

PROOF OF LEMMA 4.7. Suppose that $u^* \in Y_j$ for some j with $j \geq 1$, $j < k$. Since Φ_{t, t_0} is a time-evolution on each Y_j and G acts as C^0 -group on each Y_j w.r.t. the Y_j -norm by Lemma 4.3 we know that $B^* \in \mathcal{L}(Y_i)$, $i \leq j$. We have

$$\xi(B^* - \lambda) = (B^* - \lambda) \text{Ad}_{g^*} \xi + V(\xi),$$

with

$$V(\xi) := \partial_u^2 \Phi_{T_{\text{ext}}, 0}(u^*)(\text{Ad}_{g^*} \xi) u^* \in \mathcal{L}(Y_{j-1}).$$

Let $\lambda \in \mathbb{C} \setminus \text{spec}(B^*)$ lie in the resolvent set of B^* . Then we get

$$\text{Ad}_{g^*} \xi (B^* - \lambda)^{-1} = (B^* - \lambda)^{-1} \xi - (B^* - \lambda)^{-1} V(\xi) (B^* - \lambda)^{-1}. \quad (4.10)$$

Let B_j^* be the operator B^* considered as element of $\mathcal{L}(Y_j)$. From (4.10) we deduce that $\text{spec}(B_j^*) \subset \text{spec}(B_{j-1}^*) \subset \dots \subset \text{spec}(B_0^*)$. Let σ be the spectral set of the center-unstable eigenvalues of B^* . Then

$$P = \frac{1}{2\pi i} \oint_{\text{around } \sigma} (\lambda - B^*)^{-1} d\lambda. \quad (4.11)$$

From (4.11) we see that P maps Y_j into itself if $u^* \in Y_j$. Since Y_j is dense in Y by iterative application of Lemma 4.3 we can find $w_i \in Y_j$, $i = 1, \dots, \dim(PY)$, such that Pw_i , $i = 1, \dots, \dim(PY)$, span PY . Hence $PY \subseteq Y_j$. Since $\xi u^* \in PY$, $\xi \in \text{alg}(G)$, we infer $u^* \in Y_{j+1}$.

According to Lemma 4.5 we have $u^* \in Y_1$ if $k \geq 1$. Hence by induction we obtain

$$u^* \in Y_k, \quad PY \subseteq Y_{k-1}.$$

By computing the adjoints on both sides of equation (4.10) we see that $B^*Z_j^* \subset Z_j^*$, $0 \leq j \leq k-1$. Analogously as above we obtain $P^*Y^* \subset Z_{k-1}^*$. Using (i) and (ii) we conclude that u^* satisfies condition (S) on each Y_j , $j \leq k-1$.

To prove (iv) we apply Lemma 4.6 on each Y_j , $j \leq k-1$. Applying the contraction principle on each Y_j , $j \leq k-1$, we obtain solutions $y_j(q, g, \omega_{\text{ext}}, \mu)$ of $y = \Pi^\ell(y)$ which are continuous in the parameters and locally unique in Y_j and therefore solutions of (4.2). Since $Y_j \subseteq Y$ for all j the solutions are the same solution $y(q, g, \omega_{\text{ext}}, \mu)$. Since with $y = y(q, g, \omega_{\text{ext}}, \mu)$ also $\Pi^i(y)$, $i \in \mathbb{Z}$, are solutions of $y = \Pi^\ell(y)$ and the solution is locally unique we know that $y(q, g, \omega_{\text{ext}}, \mu)$ is a solution of (4.2).

In the same way as in Lemma 4.5 we can show that $y = y(q, g, \omega_{\text{ext}}, \mu) \in Y_k$: From $y = \Pi(y)$ we formally get the identity

$$z(\xi) = B_s z(\text{Ad}_{g^*} \xi) + \eta(\xi)$$

on Y_{k-1} where $z(\xi) = (1 - \hat{P})\xi y(q, g, \omega_{\text{ext}}, \mu)$, $B_s = \text{D}\Pi(q + y)(1 - \hat{P})$ and

$$\begin{aligned} \eta(\xi) &= -(1 - \hat{P})\xi \hat{P} \rho_g^{-1} \Phi_{T_{\text{ext}}, 0}(y + q) \\ &\quad + (1 - \hat{P}) \rho_g^{-1} \text{D}\Phi_{T_{\text{ext}}, 0}(y + q) (\hat{P} \text{Ad}_{g^*} \xi y + \text{Ad}_{g^*} \xi q). \end{aligned}$$

The operator $\eta(\xi)$ is well-defined for all $y \in Y$ and maps into Y_{k-1} because $\rho_g \hat{P}$ and $\hat{P} \rho_g$ are C^k -smooth in the $\mathcal{L}(Y)$ -norm. Since B_s has spectral radius smaller than one this equation can be solved uniquely for $z(\xi_i)$, $i = 1, \dots, m$. In the same way as in the proof of Lemma 4.5 we can now show that the formal derivative $z(\xi) + \hat{P}\xi y(q, g, \omega_{\text{ext}}, \mu)$ is indeed the derivative $\xi y(q, g, \omega_{\text{ext}}, \mu)$. We infer that $y(q, g, \omega_{\text{ext}}, \mu)$ is continuous in its parameters in the norm of Y_k . ■ In order to show that the solutions really depend C^k -smoothly on their parameters we will use a contraction mapping theorem on a scale of Banach spaces. This idea has frequently been used in the literature, for example it is used to prove the smoothness of center manifolds (Vanderbauwhede & Van Gils [30], Vanderbauwhede & Iooss [29]). Renardy [19] proved a generalized implicit function theorem on a scale of Banach spaces $\{Y_j\}_{0 \leq j \leq k}$; he required that the derivative of the nonlinear equation to be solved evaluated at the starting solution depends continuously on the parameter with respect to the norm $\|\cdot\|_{\mathcal{L}(Y_j)}$. As in [30] we will assume that the derivative is a contraction. Hard implicit function theorems can be found in Nirenberg [17]. We will employ the following theorem which is stated in general form in [30] for $k = 1$.

THEOREM 4.8 *Let $\mathcal{Y} = \mathcal{Y}_0 \supset \mathcal{Y}_1 \supset \dots \supset \mathcal{Y}_k$, $k \geq 1$, be a scale of Banach spaces with norms $\|\cdot\|_{\mathcal{Y}_j}$, $j \leq k$, and let \mathcal{Y}_j be continuously embedded in \mathcal{Y}_{j-1} . Let $(u, \nu) \rightarrow \Pi(u, \nu)$ be a nonlinear map from some open set $U \subset \mathcal{Y} \times \mathbb{R}^p$ into \mathcal{Y} . Assume the following:*

- (i) Π maps $U_j := (\mathcal{Y}_j \times \mathbb{R}^p) \cap U$ into \mathcal{Y}_j and Π is $C^{\ell-j}$ -smooth from U_ℓ to \mathcal{Y}_j , $j, \ell \in \mathbb{N}_0$, $k \geq \ell \geq j \geq 0$.

- (ii) $(\nu, u, w_1, \dots, w_j) \rightarrow \frac{\partial^{j+\ell}}{\partial u^j \partial \nu^\ell} \Pi(u, \nu)(w_1, \dots, w_j)$ is continuous as map from $U_i \times (\mathcal{Y}_i)^j$ into $\mathcal{L}^\ell(\mathbb{R}^p, \mathcal{Y}_{i-\ell})$, for $i, j, \ell \in \mathbb{N}_0$, $\ell \leq i \leq k$, $j + \ell \leq k$, where $\mathcal{L}^0(\mathbb{R}^p, \mathcal{Y}_i) := \mathcal{Y}_i$.
- (iii) $\Pi(\cdot, \nu)$ is a uniform contraction as map from U_j into \mathcal{Y}_j , $0 \leq j \leq k-1$, with contraction constant $c < 1$.

Then

- a) there is a unique solution $u(\nu) \in \mathcal{Y}_{k-1}$ to $\Pi(u, \nu) = u$ and $u(\nu)$ is a C^{k-1} -function of ν with respect to the norm $\|\cdot\|_{\mathcal{Y}}$.
- b) If we require in addition

$$(iv) \quad u(\nu) \text{ is continuous in the norm } \|\cdot\|_{\mathcal{Y}_k}$$

then $u(\nu)$ is a C^k -function of ν with respect to the norm $\|\cdot\|_{\mathcal{Y}}$.

PROOF. We can apply Banach's fixed point theorem on each \mathcal{Y}_j , $0 \leq j \leq k-1$, and since $\mathcal{Y}_j \subset \mathcal{Y}$ for $0 \leq j \leq k$ the solutions are all equal to $u(\nu)$. Under assumptions (i)–(iii) we can formally compute the first $(k-1)$ derivatives of $u(\nu)$ considered as lying in \mathcal{Y} , if we assume hypotheses (i)–(iv) then we can even compute the formal k -th derivative of $u(\nu)$ considered as lying in \mathcal{Y} . It remains to be shown that the formal derivatives are indeed the derivatives of $u(\nu)$. For $k=1$ the proof can be found in [30]. The rest is induction over k . Since this theorem is the main technical tool of our results we present the whole proof of the theorem.

1. STEP. We first show that the solution $u(\nu)$ is a C^1 -function of ν with respect to the norm of \mathcal{Y} . Assuming that $u(\nu)$ is C^0 in ν in the \mathcal{Y}_1 -norm the formal derivative $\kappa(\nu)$ is given by the equation

$$\kappa(\nu) - (\partial_u \Pi)(u(\nu), \nu) \kappa(\nu) = (\partial_\nu \Pi)(u, \nu)|_{u=u(\nu)}.$$

Since $\|(\partial_u \Pi)(u(\nu), \nu)\|_{\mathcal{L}(\mathcal{Y})} \leq c < 1$ this equation can be solved uniquely for $\kappa(\nu) \in \mathcal{Y}$. Furthermore, due to our assumption, $\kappa(\nu) \in \mathcal{Y}$ depends continuously on ν . We consider a fixed ν . In order to prove that $\kappa(\nu) = \partial_\nu u(\nu)$ we have to show that

$$\|u(\nu + \tilde{\nu}) - u(\nu) - \kappa(\nu) \tilde{\nu}\|_{\mathcal{Y}} = o(\tilde{\nu}). \quad (4.12)$$

Multiplying

$$\begin{aligned} u(\nu + \tilde{\nu}) - u(\nu) - \kappa(\nu) \tilde{\nu} &= u(\nu + \tilde{\nu}) - u(\nu) \\ &\quad - \tilde{\nu} (1 - (\partial_u \Pi)(u(\nu), \nu))^{-1} (\partial_\nu \Pi)(u, \nu)|_{u=u(\nu)} \end{aligned}$$

by $(1 - (\partial_u \Pi)(u(\nu), \nu))$ we see that (4.12) is equivalent to $\|\theta(\tilde{u}, \tilde{\nu})\|_{\mathcal{Y}} = o(\tilde{\nu})$ where $\tilde{u} = u(\nu + \tilde{\nu}) - u(\nu)$ and

$$\theta(\tilde{u}, \tilde{\nu}) = \Pi(u(\nu + \tilde{\nu}), \nu + \tilde{\nu}) - \Pi(u(\nu), \nu) - (\partial_u \Pi)(u(\nu), \nu) \tilde{u} - (\partial_\nu \Pi)(u(\nu), \nu) \tilde{\nu}.$$

We can estimate

$$\begin{aligned}
 \|\theta(\tilde{u}, \tilde{\nu})\|_{\mathcal{Y}} &\leq \|\Pi(u(\nu + \tilde{\nu}), \nu + \tilde{\nu}) - \Pi(u(\nu + \tilde{\nu}), \nu) - (\partial_{\nu}\Pi)(u(\nu), \nu)\tilde{\nu}\|_{\mathcal{Y}} \\
 &\quad + \|\Pi(u(\nu + \tilde{\nu}), \nu) - \Pi(u(\nu), \nu) - (\partial_u\Pi)(u(\nu), \nu)\tilde{u}\|_{\mathcal{Y}} \\
 &= \|(\partial_{\nu}\Pi)(u(\nu + \tilde{\nu}), \nu)\tilde{\nu} - (\partial_{\nu}\Pi)(u(\nu), \nu)\tilde{\nu}\|_{\mathcal{Y}} \\
 &\quad + o(\|\tilde{u}\|_{\mathcal{Y}}) + o(\|\tilde{\nu}\|) \\
 &\leq o(\|\tilde{\nu}\|) + o(\|\tilde{u}\|_{\mathcal{Y}}).
 \end{aligned} \tag{4.13}$$

Here we used that $u(\nu)$ is a C^0 -function of ν with respect to the norm $\|\cdot\|_{\mathcal{Y}_1}$. This follows from Banach's contraction mapping theorem applied onto \mathcal{Y}_1 or, if $k = 1$, from the additional assumption (iv). It holds

$$\theta(\tilde{u}, \tilde{\nu}) = (1 - (\partial_u\Pi)(u(\nu), \nu))\tilde{u} - (\partial_{\nu}\Pi)(u(\nu), \nu)\tilde{\nu}.$$

Hence

$$\|\tilde{u}\|_{\mathcal{Y}} \leq \frac{1}{1-c}(\|(\partial_{\nu}\Pi)(u(\nu), \nu)\|_{\mathcal{Y}}|\tilde{\nu}| + \|\theta(\tilde{u}, \tilde{\nu})\|_{\mathcal{Y}}) \leq \frac{1}{1-c}(\hat{c}|\tilde{\nu}| + o(\|\tilde{u}\|_{\mathcal{Y}})).$$

Thus, we obtain $\|\tilde{u}\|_{\mathcal{Y}} \leq \hat{c}|\tilde{\nu}|$ for $|\tilde{\nu}|$ small. From (4.13) we conclude that $\|\theta(\tilde{u}, \tilde{\nu})\|_{\mathcal{Y}} = o(\|\tilde{\nu}\|)$. Hence $u(\nu)$ is a C^1 -function of ν with respect to the norm $\|\cdot\|_{\mathcal{Y}}$.

2. STEP. To show that $u(\nu)$ is a C^i -function of ν , $i > 1$, we proceed by induction. If the theorem holds for $k = (j - 1)$, $j \geq 2$, and Π satisfies assumptions (i)–(iii) of the theorem with $k = j$ then by the contraction principle applied on \mathcal{Y}_{j-1} the function $u(\nu)$ is continuous in ν with respect to the norm $\|\cdot\|_{\mathcal{Y}_{j-1}}$. Hence by part b) of the theorem for $k = (j - 1)$ we conclude that $u(\nu)$ is C^{j-1} -smooth in ν when considered as lying in \mathcal{Y} . This proves part a) of the theorem for $k = j$. Now we come to part b). If Π satisfies assumptions (i)–(iv) of the theorem for $k = j$ then $u(\nu)$ is a C^{j-1} -function of ν in the \mathcal{Y} -norm and $u(\nu)$ is a $C^{j-\ell}$ -function of ν with respect to the norm $\|\cdot\|_{\mathcal{Y}_{\ell}}$, $j \geq \ell \geq 1$. Therefore we can apply part b) of the theorem with $k = (j - 1)$ onto the differentiated equation

$$(1 - (\partial_u\Pi)(u(\nu), \nu))\partial_{\nu}u(\nu) = (\partial_{\nu}\Pi)(u, \nu)|_{u=u(\nu)}.$$

and conclude that $\partial_{\nu}u(\nu)$ is a C^{j-1} -function of ν and that u is a C^j -function of ν with respect to the norm $\|\cdot\|_{\mathcal{Y}}$. ■

4.5 PROOF OF THE THEOREMS ON PERIODIC FORCING

We prove Theorem 2.3 by applying Theorem 4.8 onto (4.2) with $\nu = (g, q, \omega_{\text{ext}}, \mu)$ and with the hierarchy \mathcal{Y}_j of Banach spaces defined by

$$\mathcal{Y}_j = (1 - \hat{P})Y_j, \quad Y_j \text{ given by (4.4), } 0 \leq j \leq k.$$

As before \hat{P} is a projection which is $\mathcal{L}(Y, Y_{k-1})$ -near the spectral projection P onto the center-unstable eigenspace and such that $\hat{P}\rho_g$ and $\rho_g\hat{P}$ are C^k -smooth

in g in the $\mathcal{L}(Y)$ -norm. We consider the fixed point equation $y = \Pi^\ell(y)$ with ℓ so large that $D\Pi^\ell$ is a contraction on each Y_j , $0 \leq j \leq k-1$, $k \in \mathbb{N}$. Because of Lemma 4.7 all assumptions of Theorem 4.8 are satisfied. So there is a locally unique solution $y(q, g, \omega_{\text{ext}}, \mu) \in Y_k$ of $\Pi^\ell(y) = y$ if $(q, g, \omega_{\text{ext}}, \mu)$ is near $(q^*, g^*, \omega_{\text{ext}}^*, \mu^*)$ satisfying $y(q^*, g^*, \omega_{\text{ext}}^*, \mu^*) = y^*$ and $y(q, g, \omega_{\text{ext}}, \mu)$ is a C^{k-j} -function of $(q, g, \omega_{\text{ext}}, \mu)$ with respect to the norm $\|\cdot\|_{Y_j}$, $0 \leq j \leq k$. As in the proof of Lemma 4.7 we can argue that $y(q, g, \omega_{\text{ext}}, \mu)$ is also a solution of (4.2) since with $y = y(q, g, \omega_{\text{ext}}, \mu)$ also $\Pi^i(y)$, $i \in \mathbb{Z}$, are solutions of $\Pi^\ell(y) = y$ and since the solution of $y = \Pi^\ell(y)$ is locally unique.

The reduced equation (4.3) is C^{k-j} -smooth in its variables if $y(q, g, \omega_{\text{ext}}, \mu)$ is considered as lying in Y_j . Solving the reduced equation by the ordinary implicit function theorem we obtain relative periodic orbits $\Phi_{T_{\text{ext}}, 0}(u(\omega_{\text{ext}}, \mu)) = \rho_{g(\omega_{\text{ext}}, \mu)} u(\omega_{\text{ext}}, \mu)$ of (1.3) to the parameters ω_{ext}, μ with $(\omega_{\text{ext}}, \mu)$ near $(\omega_{\text{ext}}^*, \mu^*)$. Here $g(\omega_{\text{ext}}, \mu)$ is C^k -smooth in $(\omega_{\text{ext}}, \mu)$ and $u(\omega_{\text{ext}}, \mu)$ depends C^{k-j} -smoothly on $(\omega_{\text{ext}}, \mu)$ when considered as lying in Y_j .

Proposition 2.17 is proved along the same lines.

4.6 PROOF OF THE RESULTS ON HOPF BIFURCATION BY USE OF LYAPUNOV-SCHMIDT-REDUCTION

In this section we will prove Theorem 3.2 on Hopf bifurcation and Proposition 3.7 on equivariant Hopf bifurcation by Lyapunov-Schmidt-reduction. First we will prove Lemma 3.1 on the eigenvalue path $\beta(\mu)$.

4.6.1 PROOF OF LEMMA 3.1

Let P be the projection onto the center-unstable eigenspace of u^* . By Lemma 4.7 we have $P \in \mathcal{L}(Y, Y_{k-1})$ and $P^* \in \mathcal{L}(Y^*, Z_{k-1}^*)$ with the hierarchy of Banach spaces $\{Y_j\}_{0 \leq j \leq k}$ defined by (4.4).

Let u^* satisfy Hypothesis (S) and let $u^*(\mu) \in S_l$, μ small, be the C^k -smooth manifold of relative equilibria of (1.3) such that $u^*(0) = u^*$ (cf. Section 3.1). We will show:

LEMMA 4.9 *If the above assumptions hold then $u^*(\mu)$ satisfies Hypothesis (S) and the center-unstable spectral projection P of L^* can be continued to a spectral projection $P(\mu)$ of $L^*(\mu)$ such that $P(\mu)$ is C^{k-1} in μ in the space $\mathcal{L}(Y)$.*

PROOF. Let $B(\mu) = \rho_{\exp(-\xi^*(\mu)t)} D\Phi_t(u^*(\mu); \mu)$ be the linearization at the relative equilibrium $u^*(\mu)$ in the comoving frame and choose t so large that $\|(1-P)B(\mu)\| \leq c < 1$ for small μ . Let $\lambda \in \mathbb{C}$, $|\lambda| > c$. Due to Lemma 4.7 the equation

$$y = \frac{1}{\lambda}(1-P)(B(\mu)y - w + (B(\mu) - \lambda)q), \quad q \in PY, w \in Y_{k-1}$$

can be solved to get a solution $y(q, \mu, \lambda)$ for μ small enough. By Theorem 4.8 the solution $y(q, \mu, \lambda)$ is C^{k-1-j} in μ in the norm $\|\cdot\|_{Y_j}$. Now we solve the

equation

$$P(B(\mu) - \lambda)(y(q, \mu, \lambda) + q) = Pw$$

by the implicit function theorem. We conclude that $(B(\mu) - \lambda)^{-1}w$ is C^{k-j-1} in μ in the space Y_j . Let σ denote the center-unstable spectral set of $B(0)$ and denote

$$P(\mu) = \frac{1}{2\pi i} \oint_{\text{around } \sigma} (\lambda - B(\mu))^{-1} d\lambda.$$

Since $P \in \mathcal{L}(Y, Y_{k-1})$ we know that $\rho_g P(\mu)P$ is C^{k-1} -smooth in (g, μ) in the space $\mathcal{L}(Y)$. Since $P^* \in \mathcal{L}(Y^*, Z_{k-1}^*)$ we can apply the same arguments on the dual space which yields that $\rho_g^* P^*(\mu)P^*$ is C^{k-1} in (g, μ) in the space $\mathcal{L}(Y)$. The operator $P(\mu)$ is a linear combination of the operators $\langle P^*(\mu)e_i^*, \cdot \rangle P(\mu)e_i$ where $\{e_i\}_{i=1, \dots, m}$ is a basis of PY and $\{e_i^*\}_{i=1, \dots, m}$ is a basis of P^*Y . Consequently $\rho_g P(\mu)$ and $P(\mu)\rho_g$ are C^{k-1} in (g, μ) in the space $\mathcal{L}(Y)$. ■

Let $\Psi_t(\cdot)$ be the semiflow on \hat{S}_l in a comoving frame

$$\Psi_t(u; \mu) = \rho_{g(\Phi_t(u, \mu))}^{-1} \Phi_t(u + u^*(\mu); \mu) - u^*(\mu)$$

where $u \in \hat{S}_l$ is Y_1 -near u^* , and $g(u)$ is such that $\rho_{g(u)}^{-1}u \in S_l$, see also (3.5).

Let $D\Psi_t(0; 0) = e^{\tilde{L}t}$ and denote by P_l the projection onto the space \hat{S}_l such that $P_l \text{alg}(G)u^* = 0$. Then $\tilde{L} = P_l L^* P_l$.

Similarly denote $D\Psi_t(0; \mu) = e^{\tilde{L}(\mu)t}$. Then $\tilde{L}(\mu) = P_l(\mu)L^*(\mu)P_l(\mu)$ where

$$P_l(\mu)y = y - \sum_{i=1}^m \alpha_i(\mu)(y)\xi_i u^*(\mu)$$

and $\alpha_i(\mu) \in Y^*$ are such that $l_i(y - \sum_{i=1}^m \alpha_i(\mu)(y)\xi_i u^*(\mu)) = 0$, $i = 1, \dots, m$. By the above Lemma 4.9 $P_l(\mu)$ is C^{k-1} in μ in the space $\mathcal{L}(Y)$ and the operator $\tilde{L}(\mu)P(\mu)$ is C^{k-1} in μ in the space $\mathcal{L}(Y)$. So the simple eigenvalue $\beta(0) = i$ of \tilde{L} can be continued to a C^{k-1} smooth path of eigenvalues $\beta(\mu)$ of $\tilde{L}(\mu)$ with C^{k-1} smooth path of eigenvectors $w(\mu)$. Note that $\beta(\mu)$ is an eigenvalue of $L(\mu)$ as well.

4.6.2 PROOF OF THEOREM 3.2

We will study the solutions of the equation

$$0 = F(u, g, T, \mu) := \begin{pmatrix} \rho_g^{-1} \Phi_T(u, \mu) - u \\ l_i(u - u^*(\mu)), \quad i = 1, \dots, m \end{pmatrix}, \quad (4.14)$$

where $l_i \in Y^*$ and the conditions $l_i(u - u^*) = 0$, $i = 1, \dots, m$, define a section transversely to the G -orbit of u^* . Later on, we will need an additional condition to take care of the time-shift symmetry of the relative periodic orbits which we want to find. The map F is smooth in u, μ, T for $T > 0$, but only continuous in g . Further $\partial_u F(u, g, T, \mu)$ is not continuous in g with respect to the norm

$\|\cdot\|_{\mathcal{L}(Y)}$. So we can not use the usual Lyapunov-Schmidt-reduction to solve equation (4.14), but (4.14) fits into the setting which we treated in the preceding subsections, and we will use the techniques developed in these subsections to solve (4.14).

We can find a projector \hat{P} which is near P in the norm of $\mathcal{L}(Y, Y_{k-1})$ and such that $\rho_g \hat{P}$ and $\hat{P} \rho_g$ are C^k -smooth in g in the norm of $\mathcal{L}(Y)$. Consider the fixed point equation

$$y = \Pi(y, q, g, T, \mu) := (1 - \hat{P})\rho_g^{-1}\Phi_T(y + q, \mu),$$

with $y \in (1 - \hat{P})Y$, $q \in \hat{P}Y$, on the scale of Banach spaces Y_j , $0 \leq j \leq k$. This fixed point equation equals (4.2) from Section 4 with T_{ext} replaced by T and $\Phi_t(\cdot)$ autonomous. So we get a solution $y(q, g, T, \mu)$ of the fixed point equation which is C^{k-j} -smooth in its parameters in the Y_j -norm. Now we are ready to solve the reduced equation $F_{\text{red}}(q, g, T, \mu) = 0$ with F_{red} given by

$$F_{\text{red}}(q, g, T, \mu) = \begin{pmatrix} P(\rho_g^{-1}\Phi_T(q + y(q, g, T, \mu), \mu) - q - y(q, g, T, \mu)) \\ l_i(u - u^*), \quad i = 1, \dots, m \end{pmatrix}. \quad (4.15)$$

The map F_{red} is C^{k-j} -smooth in its variables when considered as map from Y_j into Y_j . The rest of the proof is standard, see [6]:

Let w be the eigenvector of \tilde{L} to the eigenvalue i . Let $\langle w^*, \cdot \rangle$ belong to the left eigenspace of L^* to the eigenvalue i such that

$$\begin{aligned} \langle \text{Re } w^*, \text{Re } w \rangle &= \langle \text{Im } w^*, \text{Im } w \rangle = 1, \\ \langle \text{Re } w^*, \text{Im } w \rangle &= \langle \text{Im } w^*, \text{Re } w \rangle = 0 \end{aligned} \quad (4.16)$$

is satisfied and $\langle w^*, \text{alg } Gu^* \rangle = 0$, $i = 1 \dots m$.

Let

$$s(q, g, T, \mu) := \frac{1}{2\pi} \langle \text{Re } w^*, \int_0^{2\pi} e^{\tilde{L}(2\pi-t)} \Psi_{\frac{Tt}{2\pi}}(y(q, g, T, \mu) + q - u^*(\mu); \mu) dt \rangle$$

where Ψ_t is the semiflow in a comoving frame as defined in (3.5). We first compute $q = q(s, T, \mu)$ and $g = g(s, T, \mu)$ as functions of s , T and μ by solving

$$F_{\text{red}} - \langle \text{Re } w^*, F_{\text{red}} \rangle \text{Re } w - \langle \text{Im } w^*, F_{\text{red}} \rangle \text{Im } w = 0.$$

and

$$\langle \text{Im } w^*, \int_0^{2\pi} e^{\tilde{L}(2\pi-t)} \Psi_{\frac{Tt}{2\pi}}(y(q, g, T, \mu) + q - u^*(\mu); \mu) dt \rangle = 0.$$

The last condition fixes the time-shift. Now we still have to solve the C^k -function $\hat{F} : \mathbb{R}^3 \rightarrow \mathbb{R}^2$, $(s, T, \mu) \rightarrow \hat{F}(s, T, \mu)$ given by

$$\hat{F}(s, T, \mu) = \begin{pmatrix} \langle \text{Im } w^*, F_{\text{red}}(q(s, T, \mu), g(s, T, \mu), T, \mu) \rangle \\ \langle \text{Re } w^*, F_{\text{red}}(q(s, T, \mu), g(s, T, \mu), T, \mu) \rangle \end{pmatrix} = 0.$$

Obviously $\hat{F}(0, T, \mu) = 0$, $\partial_{(s, T, \mu)} \hat{F}(0, 2\pi, 0) = 0$. We define

$$F_{LS}(s, T, \mu) := \frac{1}{s} \hat{F}(s, T, \mu).$$

Since

$$\lim_{s \rightarrow 0} \frac{1}{s} \hat{F}(s, T, \mu) = \partial_s F_{LS}(0, T, \mu)$$

and $\partial_s \hat{F}(0, 2\pi, 0) = 0$ we have $F_{LS}(0, 2\pi, 0) = 0$. Furthermore $\partial_T F_{LS}(0, T, \mu) = \partial_T \partial_s \hat{F}(0, T, \mu)$ and $\partial_\mu F_{LS}(0, T, \mu) = \partial_\mu \partial_s \hat{F}(0, T, \mu)$, since $\partial_{(T, \mu)} \hat{F}(0, T, \mu) = 0$.

LEMMA 4.10 *Under the assumptions of Theorem 3.2 the derivative*

$$\partial_{(T, \mu)} F_{LS}(0, 2\pi, 0)$$

of F_{LS} in $(s, T, \mu) = (0, 2\pi, 0)$ has full rank.

PROOF OF LEMMA 4.10. We have

$$\partial_{(T, \mu)} F_{LS}(0, 2\pi, 0) = \begin{pmatrix} \langle \operatorname{Im} w^*, \partial_{(T, \mu)} \partial_u \Psi_{2\pi}(0; 0) \operatorname{Re} w \rangle \\ \langle \operatorname{Re} w^*, \partial_{(T, \mu)} \partial_u \Psi_{2\pi}(0; 0) \operatorname{Re} w \rangle \end{pmatrix} \quad (4.17)$$

We invoke the following lemma which is the adaption of a lemma in Crandall & Rabinowitz [6] to our setting.

LEMMA 4.11 *Let assumptions (i)–(iii) of Theorem 3.2 hold. Then*

$$\begin{aligned} \langle \operatorname{Re} w^*, \partial_\mu \partial_u \Psi_{2\pi}(0; 0) \operatorname{Re} w \rangle &= 2\pi \operatorname{Re} \frac{\partial \beta}{\partial \mu}(0), \\ \langle \operatorname{Im} w^*, \partial_\mu \partial_u \Psi_{2\pi}(0; 0) \operatorname{Re} w \rangle &= -2\pi \operatorname{Im} \frac{\partial \beta}{\partial \mu}(0), \end{aligned} \quad (4.18)$$

where $\langle w^*, \cdot \rangle$ is the left eigenvector of \tilde{L} to the eigenvalue i which satisfies (4.16).

We have

$$\partial_T \partial_u \Psi_{2\pi}(0; 0) \operatorname{Re} w = \tilde{L} e^{\tilde{L} 2\pi} \operatorname{Re} w = \operatorname{Im} w.$$

Using Lemma 4.11 and condition (iv) we conclude that $\partial_{(T, \mu)} F_{LS}(0, 2\pi, 0)$ has full rank. \blacksquare

Because of Lemma 4.10 we can apply the ordinary implicit function theorem to obtain solutions $u(s, \mu_2) := u^*(\mu(s, \mu_2)) + z(s, \mu_2)$, $g(s, \mu_2)$, $T(s, \mu_2)$, $\mu(s, \mu_2) = (\mu_1(s, \mu_2), \mu_2)$ of (4.14) which are relative periodic orbits with $l_i(z(s, \mu_2)) = 0$, $i = 1, \dots, m$. Here $\mu(s, \mu_2)$, $g(s, \mu_2)$, $T(s, \mu_2)$ are C^{k-1} -smooth in s, μ_2 . Moreover, $z(s, \mu_2)$ is C^{k-1} -smooth in the $\|\cdot\|_Y$ -norm and C^{k-j-1} -smooth in the $\|\cdot\|_{Y_j}$ -norm, $1 \leq j \leq k-1$.

We have $z(-s, \mu_2) = \Psi_{\frac{T(s, \mu_2)}{2}}(z(s, \mu_2); \mu(s, \mu_2))$. Since $\mu(s, \mu_2)$, $T(s, \mu_2)$ do not depend on the time-shift, they are even in s .

The solutions $u(s) = u^*(\mu(s)) + z(s)$, $g(s)$, $T(s)$, $\mu(s)$ of (4.14) which we obtained above (for convenience we ignore the μ_2 -dependence of the solutions

in the notation) depend C^{k-1} -smoothly on the chosen eigenvector of \tilde{L} to the eigenvalue i . We can also consider $z_l \in Y$, g_l , T_l , μ_l as C^{k-1} -smooth functions of $(s_1 + is_2)w$ where $s_1, s_2 \in \mathbb{R}$ and w is the originally chosen eigenvector of \tilde{L} to i . As before, $z_l(s_1, s_2)$ is C^{k-j-1} -smooth in the Y_j -norm, $1 \leq j < k$. We have $z(s) = z_l(s_1, 0)$ and

$$e^{i\tau} = \langle \operatorname{Re} w^* + i \operatorname{Im} w^*, \int_0^{2\pi} e^{\tilde{L}(2\pi-t)} \Psi_{\frac{(t+\tau)T(s)}{2\pi}}(z(s); \mu(s)) dt \rangle.$$

Obviously $\mu(s) = \mu_l(s_1, s_2)$, $T(s) = T_l(s_1, s_2)$ only depend on $s = \|(s_1, s_2)\|$,

$$z_l(s_1, s_2) := \Psi_{\frac{\tau T(s)}{2\pi}}(z(s); \mu(s)), \quad \text{where } s_1 = s \cos \tau, \quad s_2 = s \sin \tau,$$

and $u_l(s_1, s_2) = u^*(\mu(s)) + z_l(s_1, s_2)$. ■

4.6.3 EQUIVARIANT HOPF BIFURCATION

In this subsection we prove Lemma 3.7, see also section 3.3. If the isotropy K of the relative equilibrium u^* is non-trivial it may happen that forced by symmetry the eigenspace of the K -equivariant matrix \tilde{L} to the Hopf eigenvalue i has dimension higher than 2. Then the assumptions of Theorem 3.2 are not satisfied any more.

We choose functionals l_i , $i = 1, \dots, m_K$, which define a section $S_l = u^* + \hat{S}_l$ transversal to the group orbit Gu^* in u^* such that \hat{S}_l is K -invariant and that P_l is K -equivariant, see subsection 3.3. Here $m_K = \dim(G/K)$.

If $\Theta(K) = Z_\ell$ then we solve the equation

$$F(u, g, T, \mu) = \begin{pmatrix} \rho(gh^*)^{-1} \Phi_T(u, \mu) - u \\ l_i(u - u^*), \quad i = 1, \dots, m_K \end{pmatrix} = 0 \quad (4.19)$$

on $\operatorname{Fix}(K_{\text{bif}})$ where $T \approx 2\pi/\ell$, $g \approx e^{\frac{2\pi}{\ell}\xi^*}$, the group H is generated by $h^* \in K$ and $K_{\text{bif}} = \ker(\Theta)$ is axial. By our assumptions $DF_u(u^*, e^{\frac{2\pi}{\ell}\xi^*}, 2\pi/\ell, 0)|_{\hat{S}_l}$ has a two-dimensional kernel and therefore (4.19) can be solved by the methods of subsection 4.6.2.

If $\Theta(K) = S^1$ we solve

$$F(u, g, T, \mu) = \begin{pmatrix} \rho_g^{-1} \exp(-\chi^* T) \Phi_T(u, \mu) - u \\ l_i(u - u^*), \quad i = 1, \dots, m_K \end{pmatrix} = 0 \quad (4.20)$$

on $\operatorname{Fix}(K_{\text{bif}})$. In this case the axial group H is generated by $\chi^* \in \operatorname{alg}(K)$ and $K_{\text{bif}} = \ker(\Theta)$. We choose T such that $(\rho_{e^{-\chi^* T}} e^{\tilde{L}T} - 1)|_{\hat{S}_l}$ has a two-dimensional kernel. This is possible because the number of center eigenvalues of \tilde{L} is finite. Then we can proceed as before. ■

REFERENCES

- [1] P. Ashwin and I. Melbourne. Noncompact drift for relative equilibria and relative periodic orbits. *Nonlinearity*, 10:595 – 616, 1997.
- [2] P. Ashwin, I. Melbourne and M. Nicol. Drift bifurcations of relative equilibria and transitions of spiral waves. *Nonlinearity*, 12:741–755, 1999.
- [3] D. Barkley. Linear stability analysis of rotating spiral waves in excitable media. *Phys. Rev. Lett.*, 68(13):2090–2093, 1992.
- [4] D. Barkley. Euclidean symmetry and the dynamics of rotating spiral waves. *Phys. Rev. Lett.*, 72:164–167, 1994.
- [5] M. Braune and H. Engel. Compound rotation of spiral waves in a light-sensitive Belousov-Zhabotinsky medium. *Chem. Phys. Lett.*, 204(3,4):257–264, 1993.
- [6] M. Crandall and P. Rabinowitz. The Hopf bifurcation theorem in infinite dimensions. *Arch. Rat. Mech. Anal.*, 67:53–72, 1977.
- [7] B. Fiedler, B. Sandstede, A. Scheel, and C. Wulff. Bifurcation from relative equilibria to non-compact group actions: Skew products, meanders, and drifts. *Doc. Math. J. DMV*, 1:479 – 505, 1996.
- [8] B. Fiedler, D. Turaev. Normal forms, resonances, and meandering tip motions near relative equilibria of Euclidean group actions. *Arch. Rat. Mech. Anal.*, 145:129 – 159, 1998.
- [9] M.J. Field, Local structure for equivariant dynamics, *Singularity Theory and its Applications, Part II* (M. Roberts and I. Stewart, eds.), Lecture Notes in Math., vol. 1463, Springer, New York, 1991, pp. 142–166.
- [10] M. Golubitsky, V. LeBlanc, and I. Melbourne. Meandering of the spiral tip – an alternative approach. *J. Nonl. Sc.*, 7:557–586, 1997.
- [11] M. Golubitsky, I. Stewart, and D. Schaeffer. *Singularities and Groups in Bifurcation Theory*, Vol. II, Applied Mathematical Sciences, vol. 69, Springer, Berlin, 1988.
- [12] F. P. Greenleaf. *Invariant Means on Topological Groups*. Number 16 in Van Nostrand Mathematical Studies. American Book Company, U.S.A., 1969.
- [13] Dan Henry. *Geometric Theory of Semilinear Parabolic Equations*. Lecture Notes in Mathematics. Springer Verlag, Berlin, Heidelberg, New York, 1981.

- [14] W. Jahnke, W.E. Skaggs, and A.T. Winfree. Chemical vortex dynamics in the Belousov-Zhabotinskii reaction and in the two-variable Oregonator model. *J. Chem. Phys.*, 93:740–749, 1989.
- [15] R. M. Mantel and D. Barkley. Parametric forcing of scroll-wave patterns in three-dimensional excitable media. *Preprint*, IMA, 1998.
- [16] S. Nettesheim, A. von Oertzen, H.H. Rotermund, and G. Ertl. Reaction diffusion patterns in the catalytic CO-oxidation on Pt(110) – front propagation and spiral waves. *J. Chem. Phys.*, 98:9977–9985, 1993.
- [17] L. Nirenberg. *Topics in Nonlinear Functional Analysis*. Lecture Notes Courant Inst. Math. Sci. New York University, 1974.
- [18] A.V. Panfilov and A. T. Winfree. Dynamical simulations of twisted scroll rings in three dimensional excitable media. *Physica D*, 17:323–330, 1985.
- [19] M. Renardy. Bifurcation from rotating waves. *Arch. Rat. Mech. Anal.*, 79:49–84, 1982.
- [20] M. Renardy and H. Haken. Bifurcations of solutions of the Laser equations. *Physica D*, 8:57–89, 1983.
- [21] B. Sandstede, A. Scheel, and C. Wulff. Center-manifold reduction for spiral waves. *C. R. Acad. Sc., Série I, Math.*, 324:153 – 158, 1997.
- [22] B. Sandstede, A. Scheel, and C. Wulff. Dynamics of spiral waves on unbounded domains using center-manifold reductions. *J. Diff. Eq.*, 141:122–149, 1997.
- [23] B. Sandstede, A. Scheel, and C. Wulff. Bifurcations and dynamics of spiral waves. *J. Nonlin. Sci.*, 9(4):439–478, 1999.
- [24] A. Scheel. Subcritical bifurcation to infinitely many rotating waves. *J. Math. Anal. Appl.*, 215:252–261, 1997.
- [25] A. Scheel. Bifurcation to spiral waves in reaction-diffusion systems. *SIAM J. Math. Anal.* , 29:1399–1418, 1998.
- [26] G.S. Skinner and H.L. Swinney. Periodic to quasiperiodic transition of chemical spiral rotation. *Physica D*, 48:1–16, 1991.
- [27] O. Steinbock, S.C. Müller and V.S. Zykov. Control of spiral wave dynamics in active media by periodic modulation of excitability. *Nature*, 366:322–324, 1993.
- [28] A. Vanderbauwhede. Centre manifolds, normal forms and elementary bifurcations. *Dyn. Rep.*, 2:89–169, 1989.
- [29] A. Vanderbauwhede and G. Iooss. Centre manifold theory in infinite dimensions. *Dyn. Rep.*, 1:125–163, 1992.

- [30] A. Vanderbauwhede, S. A. van Gils. Center manifolds and contractions on a scale of Banach spaces. *J. Funct. Anal.*, 72:209 – 224, 1987.
- [31] V.S. Varadarajan. *Lie groups, Lie algebras and their representations*. Prentice-Hall, 1974.
- [32] A.T. Winfree. Varieties of spiral wave behaviour: an experimentalist's approach to the theory of excitable media. *Chaos*, 1:303–334, 1991.
- [33] C. Wulff. *Theory of meandering and drifting spiral waves in reaction-diffusion systems*. Dissertation, Berlin, 1996.
- [34] C. Wulff, J.S.W. Lamb, and I. Melbourne. Bifurcations from relative periodic solutions. *Erg. Th. Dyn. Syst.*, to appear.
- [35] V. Zykov, O. Steinbock, and S.C. Müller. External forcing of spiral waves. *Chaos*, 4(3):509–518, 1994.
- [36] V. S. Zykov and S. C. Müller. Spiral waves on circular and spherical domains of excitable medium. *Physica D*, 97:322 – 332, 1996.

Claudia Wulff
Institut für Mathematik I
Freie Universität Berlin
Arnimallee 2-6
14195 Berlin, Germany
wulff@math.fu-berlin.de

THE NUMBER OF
INDEPENDENT VASSILIEV INVARIANTS IN
THE HOMFLY AND KAUFFMAN POLYNOMIALS

JENS LIEBERUM

Received: February 17, 2000

Communicated by Günter M. Ziegler

ABSTRACT. We consider vector spaces $\mathcal{H}_{n,\ell}$ and $\mathcal{F}_{n,\ell}$ spanned by the degree- n coefficients in power series forms of the Homfly and Kauffman polynomials of links with ℓ components. Generalizing previously known formulas, we determine the dimensions of the spaces $\mathcal{H}_{n,\ell}$, $\mathcal{F}_{n,\ell}$ and $\mathcal{H}_{n,\ell} + \mathcal{F}_{n,\ell}$ for all values of n and ℓ . Furthermore, we show that for knots the algebra generated by $\bigoplus_n \mathcal{H}_{n,1} + \mathcal{F}_{n,1}$ is a polynomial algebra with $\dim(\mathcal{H}_{n,1} + \mathcal{F}_{n,1}) - 1 = n + \lfloor n/2 \rfloor - 4$ generators in degree $n \geq 4$ and one generator in degrees 2 and 3.

1991 Mathematics Subject Classification: 57M25.

Keywords and Phrases: Vassiliev invariants, link polynomials, Brauer algebra, Vogels algebra, dimensions.

1 INTRODUCTION

Soon after the discovery of the Jones polynomial V ([Jon]), two 2-parameter generalizations of it were introduced: the Homfly polynomial H ([HOM]) and the Kauffman polynomial F ([Ka2]) of oriented links. Let $\mathcal{V}_{n,\ell}$ be the vector space of \mathbb{Q} -valued Vassiliev invariants of degree n of links with ℓ components. After a substitution of parameters, the polynomial H (resp. F) can be written as a power series in an indeterminate h , such that the coefficient of h^n is a polynomial-valued Vassiliev invariant p_n (resp. q_n) of degree n . Let $\mathcal{H}_{n,\ell}$ (resp. $\mathcal{F}_{n,\ell}$) be the vector space generated by the coefficients of p_n (resp. q_n) regarded as a subspace of $\mathcal{V}_{n,\ell}$. The dimensions of $\mathcal{H}_{n,\ell}$ and $\mathcal{F}_{n,\ell}$ have been determined in [Men] for $n \geq 0$ and $\ell = 1$ and partial results were also known for $\ell > 1$. We complete these formulas by calculating $\dim \mathcal{H}_{n,\ell}$, $\dim \mathcal{F}_{n,\ell}$ and $\dim(\mathcal{H}_{n,\ell} + \mathcal{F}_{n,\ell})$ for $n \geq 0$ and all pairs (n, ℓ) .

THEOREM 1. (1) For all $n, \ell \geq 1$ we have

$$\dim \mathcal{H}_{n,\ell} = \min \left\{ n, \left\lceil \frac{n-1+\ell}{2} \right\rceil \right\} = \begin{cases} n & \text{if } n < \ell, \\ \lceil \frac{n-1+\ell}{2} \rceil & \text{if } n \geq \ell. \end{cases}$$

(2) If $n \geq 4$, then

$$\dim \mathcal{F}_{n,\ell} = \begin{cases} n-1 & \text{if } \ell = 1, \\ 2n-1 & \text{if } \ell \geq 2 \text{ and } n \leq \ell, \\ n+\ell-1 & \text{if } \ell \geq 2 \text{ and } n \geq \ell. \end{cases}$$

The values of $\dim \mathcal{F}_{n,\ell}$ for $n \leq 3$ are given in the following table

(n, ℓ)	(1, 1)	(1, ≥ 2)	(2, 1)	(2, 2)	(2, ≥ 3)	(3, 1)	(3, 2)	(3, ≥ 3)
$\dim \mathcal{F}_{n,\ell}$	0	1	1	2	3	1	4	5

(3) For all $n, \ell \geq 1$ we have

$$\dim(\mathcal{H}_{n,\ell} \cap \mathcal{F}_{n,\ell}) = \min\{\dim \mathcal{H}_{n,\ell}, 2\}.$$

In the framework of Vassiliev invariants it is natural to consider the elements of $\bigoplus_{n,\ell}(\mathcal{H}_{n,\ell} \cap \mathcal{F}_{n,\ell})$ as *the common specializations of H and F* . It is known that a one-variable polynomial Y ([CoG], [Kn1], [Lik], [Lie], [Sul]) appears as a lowest coefficient in H and F . This is used in the proof of Theorem 1 to derive lower bounds for $\dim(\mathcal{H}_{n,\ell} \cap \mathcal{F}_{n,\ell})$. Let r_n^ℓ be the coefficient of h^n in the Jones polynomial $V(e^{h/2})$ and let y_n^ℓ be the coefficient of h^n in $Y(e^{h/2})$. Then we have $r_n^\ell, y_n^\ell \in \mathcal{H}_{n,\ell} \cap \mathcal{F}_{n,\ell}$. The following corollary to the proof of Theorem 1 says that the Jones polynomial V and the polynomial Y are *the only* common specializations of H and F in the sense above (compare [Lam] for common specializations in a different sense).

COROLLARY 2. For all $n \geq 0, \ell \geq 1$ we have $\mathcal{H}_{n,\ell} \cap \mathcal{F}_{n,\ell} = \text{span}\{r_n^\ell, y_n^\ell\}$.

The main part of the proofs of Theorem 1 and Corollary 2 will not be given on the level of link invariants, but on the level of weight systems. A weight system of degree n is a linear form on a space $\bar{\mathcal{A}}_{n,\ell}$ generated by certain trivalent graphs with ℓ distinguished oriented circles and $2n$ vertices called *trivalent diagrams*. There exists a surjective map W from $\mathcal{V}_{n,\ell}$ to the space $\bar{\mathcal{A}}_{n,\ell}^* = \text{Hom}(\bar{\mathcal{A}}_{n,\ell}, \mathbb{Q})$ of weight systems. The restriction of W to $\mathcal{H}_{n,\ell} + \mathcal{F}_{n,\ell}$ is injective. So we may study the spaces $\mathcal{H}'_{n,\ell} = W(\mathcal{H}_{n,\ell})$ and $\mathcal{F}'_{n,\ell} = W(\mathcal{F}_{n,\ell}) \subseteq \bar{\mathcal{A}}_{n,\ell}^*$ instead of $\mathcal{H}_{n,\ell}$ and $\mathcal{F}_{n,\ell}$. Using an explicit description of weight systems in $\mathcal{H}'_{n,\ell}$ and $\mathcal{F}'_{n,\ell}$ we derive upper bounds for $\dim \mathcal{H}'_{n,\ell}$ and $\dim \mathcal{F}'_{n,\ell}$. We obtain an upper bound for $\dim(\mathcal{H}'_{n,\ell} + \mathcal{F}'_{n,\ell})$ from a lower bound for $\dim(\mathcal{H}'_{n,\ell} \cap \mathcal{F}'_{n,\ell})$. We evaluate the weight systems in $\mathcal{H}'_{n,\ell}$ and $\mathcal{F}'_{n,\ell}$ on many trivalent diagrams which gives us lower bounds for $\dim \mathcal{H}'_{n,\ell}$, $\dim \mathcal{F}'_{n,\ell}$ and $\dim(\mathcal{H}'_{n,\ell} + \mathcal{F}'_{n,\ell})$. These lower bounds always coincide with the upper bounds. The resulting dimension formulas will imply Theorem 1.

For simplicity of notation we will drop the index ℓ when $\ell = 1$. The fact that the Jones polynomial and the square of the Jones polynomial appear by choosing special values of parameters of the Kauffman polynomial gives us quadratic relations between elements of $\bigoplus_{n=0}^{\infty} \mathcal{F}_{n,\ell}$. We will use the Hopf algebra structure of $\bar{\mathcal{A}} = \bigoplus_{n=0}^{\infty} \bar{\mathcal{A}}_n$ to show that we know all algebraic relations between elements of $\bigoplus_{n=0}^{\infty} \mathcal{H}_n + \mathcal{F}_n$:

THEOREM 3. *The algebra generated by $\bigoplus_{n=0}^{\infty} \mathcal{H}_n + \mathcal{F}_n$ is a polynomial algebra with*

$$\max\{\dim(\mathcal{H}_n + \mathcal{F}_n) - 1, 1\} = \max\{n + [n/2] - 4, 1\}$$

generators in degree $n \geq 2$.

If knot invariants v_i satisfy $v_i(K_1) = v_i(K_2)$, then polynomials in the invariants v_i also cannot distinguish the knots K_1 and K_2 . By Theorem 3 there is only one algebraic relation between elements $v_i \in \bigoplus_{n=1}^{m-1} (\mathcal{H}_n + \mathcal{F}_n)$ and elements of $\mathcal{H}_m + \mathcal{F}_m$ in each degree $m \geq 4$. This gives us a hint why it is possible to distinguish many knots by comparing their Homfly and Kauffman polynomials.

The plan of the paper is the following. In Section 2 we recall the definitions of the link polynomials H, F, V, Y , and we give the exact definitions of $\mathcal{H}_{n,\ell}$ and $\mathcal{F}_{n,\ell}$. Then we express relations between these polynomials in terms of Vassiliev invariants. In Section 3 we define $\bar{\mathcal{A}}_{n,\ell}$ and recall the connection between the Vassiliev invariants in $\mathcal{H}_{n,\ell} + \mathcal{F}_{n,\ell}$ and their weight systems in $\mathcal{H}'_{n,\ell} + \mathcal{F}'_{n,\ell}$. In Section 4 we use a direct combinatorial description of the weight systems in $\mathcal{H}'_{n,\ell}$ and $\mathcal{F}'_{n,\ell}$ to derive upper bounds for $\dim \mathcal{H}'_{n,\ell}$ and $\dim \mathcal{F}'_{n,\ell}$. For the proof of lower bounds we state formulas for values of weight systems in $\mathcal{H}'_{n,\ell}$ and $\mathcal{F}'_{n,\ell}$ on certain trivalent diagrams in Section 5. We prove these formulas by making calculations in the Brauer algebra \mathbf{Br}_k . In Section 6 we complete the proofs of Theorem 1, Corollary 2 and Theorem 3 by using a module structure on the space of primitive elements \mathcal{P} of $\bar{\mathcal{A}}$ over Vogel's algebra Λ ([Vog]).

ACKNOWLEDGEMENTS

I would like to thank C.-F. Bödigheimer, C. Kassel, J. Kneissler, T. Mennel, H. R. Morton, and A. Stoimenov for helpful remarks and discussions that influenced an old version of this article entitled "The common specializations of the Homfly and Kauffman polynomials". I thank the Graduiertenkolleg for mathematics of the University of Bonn, the German Academic Exchange Service, and the Schweizerischer Nationalfonds for financial support.

2 VASSILIEV INVARIANTS AND LINK POLYNOMIALS

A singular link is an immersion of a finite number of oriented circles into \mathbb{R}^3 whose only singularities are transversal double points. A singular link without

double points is called a link. We consider singular links up to orientation preserving diffeomorphisms of \mathbb{R}^3 . The equivalence classes of this equivalence relation are called singular link types or by abuse of language simply singular links. A link invariant is a map from link types into a set. If v is a link invariant with values in an abelian group, then it can be extended recursively to an invariant of singular links by the local replacement rule $v(L_\times) = v(L_+) - v(L_-)$ (see Figure 1). A link invariant is called a *Vassiliev* invariant of degree n if it vanishes on all singular links with $n + 1$ double points. Let $\mathcal{V}_{n,\ell}$ be the vector space of \mathbb{Q} -valued Vassiliev invariants of degree n of links with ℓ components.

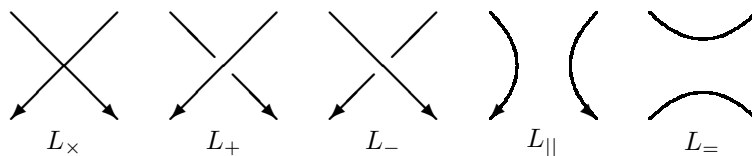

Figure 1: Local modifications (of a diagram) of a (singular) link

Let us recall the definitions of the link invariants H, F, V , and Y (see [HOM], [Ka2], [Jon], and Proposition 4.7 of [Lik]; the normalizations of H and V we will use are equivalent to the original definitions). For a link L , the Homfly polynomial $H_L(x, y) \in \mathbb{Z}[x^{\pm 1}, y^{\pm 1}]$ is given by

$$xH_{L_+}(x, y) - x^{-1}H_{L_-}(x, y) = yH_{L_{||}}(x, y), \quad (1)$$

$$H_{O^k}(x, y) = \left(\frac{x - x^{-1}}{y} \right)^k. \quad (2)$$

The links in Equation (1) are the same outside of a small ball and differ inside this ball as shown in Figure 1. The symbol O^k denotes the trivial link with $k \geq 1$ components.

A link diagram $L \subset \mathbb{R}^2$ is a generic projection of a link together with the information which strand is the overpassing strand at each double point of the projection. Call a crossing of a link diagram as in L_+ (see Figure 1) positive and a crossing as in L_- negative. Define the *writhe* $w(L)$ of a link diagram L as the number of positive crossings minus the number of negative crossings. Similar to the Homfly polynomial, the Dubrovnik version of the *Kauffman* polynomial $F_L(x, y) \in \mathbb{Z}[x^{\pm 1}, y^{\pm 1}]$ of a link diagram L is given by

$$xF_{L_+}(x, y) - x^{-1}F_{L_-}(x, y) = y \left(F_{L_{||}}(x, y) - x^{w(L_{=,or}) - w(L_{||})} F_{L_{=,or}}(x, y) \right), \quad (3)$$

$$F_{O^k}(x, y) = \left(\frac{x - x^{-1} + y}{y} \right)^k. \quad (4)$$

Here the link diagrams $L_+, L_-, L_{||}, L_=$ differ inside of a disk as shown in Figure 1 and coincide on the outside of this disk, and $L_{=,or}$ is the link diagram $L_=$

equipped with an arbitrary orientation of the components of the corresponding link. The symbol O^k denotes an arbitrary diagram of the trivial link with $k \geq 1$ components. The Homfly and the Kauffman polynomials are invariants of links. Let $|L|$ denote the number of components of a link L . For the links in Equation (1) we have $|L_+| = |L_-| = |L_{||} \pm 1$. Since Equations (1) and (2) are sufficient to calculate H this implies $H_L(x, y) = (-1)^{|L|} H_L(x, -y)$ for every link L . The Jones polynomial V can be expressed in terms of the Homfly polynomial as

$$V_L(x) := H_L(x^2, x^{-1} - x) = (-1)^{|L|} H_L(x^2, x - x^{-1}) \in \mathbb{Z}[x^{\pm 1}].$$

It is easy to see that for every link L we have

$$\tilde{H}_L(x, y) := y^{|L|} H_L(x, y) \in \mathbb{Z}[x^{\pm 1}, y], \quad \tilde{F}_L(x, y) := y^{|L|} F_L(x, y) \in \mathbb{Z}[x^{\pm 1}, y]. \tag{5}$$

The link invariant Y is defined by

$$Y_L(x) = \tilde{H}_L(x, 0) \in \mathbb{Z}[x^{\pm 1}].$$

After substitutions of parameters we can express H and F as

$$H_L(e^{ch/2}, e^{h/2} - e^{-h/2}) = \sum_{j=0}^{\infty} \sum_{i=1}^{j+|L|} p_{i,j}^{|L|}(L) c^i h^j \in \mathbb{Q}[c][[h]], \tag{6}$$

$$F_L(e^{(c-1)h/2}, e^{h/2} - e^{-h/2}) = \sum_{j=0}^{\infty} \sum_{i=1}^{j+|L|} q_{i,j}^{|L|}(L) c^i h^j \in \mathbb{Q}[c][[h]], \tag{7}$$

for the following reasons: Equation (5) implies that the sum over i is limited by $j+|L|$ in these expressions and one sees that no negative powers in h appear and that the sum over i starts with $i = 1$ directly by using the defining equations of H and F with the new parameters. For $j = 0$ we have $p_{i,0}^{|L|} = q_{i,0}^{|L|} = \delta_{i,|L|}$, where $\delta_{i,j}$ is 1 for $i = j$ and is 0 otherwise. It follows from Equations (1) and (3) that the link invariants $p_{i,n}^\ell$ and $q_{i,n}^\ell$ are in $\mathcal{V}_{n,\ell}$. Define

$$\mathcal{H}_{n,\ell} = \text{span}\{p_{1,n}^\ell, p_{2,n}^\ell, \dots, p_{n+\ell,n}^\ell\} \subseteq \mathcal{V}_{n,\ell}, \tag{8}$$

$$\mathcal{F}_{n,\ell} = \text{span}\{q_{1,n}^\ell, q_{2,n}^\ell, \dots, q_{n+\ell,n}^\ell\} \subseteq \mathcal{V}_{n,\ell}. \tag{9}$$

Define the invariants y_n^ℓ, r_n^ℓ of links with ℓ components by

$$Y_L(e^{h/2}) = \sum_{n=0}^{\infty} y_n^{|L|}(L) h^n \in \mathbb{Q}[[h]], \tag{10}$$

$$V_L(e^{h/2}) = \sum_{n=0}^{\infty} r_n^{|L|}(L) h^n \in \mathbb{Q}[[h]]. \tag{11}$$

In the following proposition we state the consequences of Propositions 4.7, 4.2, 4.5 of [Lik] for the versions of the Homfly and Kauffman polynomials from Equations (6) and (7).

PROPOSITION 4. For all $n \geq 0, \ell \geq 1$ we have

$$\begin{aligned}
 (1) \quad & y_n^\ell = p_{n+\ell, n}^\ell = q_{n+\ell, n}^\ell, \\
 (2) \quad & r_n^\ell = (-1)^\ell \sum_{i=1}^{n+\ell} 2^i p_{i, n}^\ell = (-1/2)^n \sum_{i=1}^{n+\ell} (-2)^i q_{i, n}^\ell, \\
 (3) \quad & (-2)^n \sum_{i=1}^{n+\ell} 4^i q_{i, n}^\ell = \sum_{m=0}^n \sum_{i=1}^{m+\ell} \sum_{j=1}^{n-m+\ell} (-2)^{i+j} q_{i, m}^\ell q_{j, n-m}^\ell.
 \end{aligned}$$

Sketch of Proof. (1) The following formulas for Y can directly be derived from its definition:

$$\begin{aligned}
 (a) \quad & xY_{L_+}(x) - x^{-1}Y_{L_-}(x) = Y_{L_{||}}(x) \quad \text{if } |L_+| < |L_{||}|, \\
 (b) \quad & xY_{L_+}(x) = x^{-1}Y_{L_-}(x) \quad \text{if } |L_+| > |L_{||}|, \\
 (c) \quad & Y_{O^k}(x) = (x - x^{-1})^k.
 \end{aligned}$$

These relations are sufficient to calculate $Y_L(x)$ for every link L . The link invariant $Y'_L(x) := \tilde{F}_L(x, 0)$ satisfies the same Relations (a), (b), (c) as Y , hence we have $\tilde{H}_L(x, 0) = Y_L(x) = Y'_L(x) = \tilde{F}_L(x, 0)$. Now the formulas

$$\tilde{H}_L(e^{h/2}, 0) = \sum_{n=0}^{\infty} p_{n+|L|, n}^{|L|}(L)h^n \quad \text{and} \quad \tilde{F}_L(e^{h/2}, 0) = \sum_{n=0}^{\infty} q_{n+|L|, n}^{|L|}(L)h^n$$

imply Part (1) of the proposition.

(2) Let $\langle L \rangle (A)$ be the Kauffman bracket (see [Ka1], [Ka3]) defined by

$$\langle \times \rangle = A \langle \rangle \langle \rangle + A^{-1} \langle \rangle \langle \rangle, \quad \langle O^k \rangle = (-A^2 - A^{-2})^k.$$

For a link diagram L define the link invariant $f_L(A)$ with values in $\mathbb{Z}[A^2, A^{-2}]$ by $f_L(A) = (-A^3)^{-w(L)} \langle L \rangle (A)$, where $w(L)$ denotes the writhe of L . Then one can show that

$$\begin{aligned}
 F_L(e^{-3h/2}, e^{h/2} - e^{-h/2}) &= f_L(-e^{-h/2}) = f_L(e^{-h/2}) \quad \text{and} \\
 (-1)^{|L|} H_L(e^h, e^{h/2} - e^{-h/2}) &= V_L(e^{h/2}) = f_L(e^{h/4}).
 \end{aligned}$$

This implies Part (2) of the proposition.

(3) With the notation of Part (2) of the proof we have

$$F_L(B^3, B - B^{-1}) = f_L(-A^{-1})^2 = F_L(A^{-3}, A - A^{-1})^2, \text{ where } B = A^{-2}.$$

Substituting $A = e^{\hbar/2}$ and $B = e^{\hbar/2}$ with $\hbar = -2h$ and comparing with Equation (7) gives us Part (3) of the proposition. \square

Parts (1) and (2) of Proposition 4 imply that $r_n^\ell, y_n^\ell \in \mathcal{H}_{n,\ell} \cap \mathcal{F}_{n,\ell}$. In other words, the polynomials V and Y are common specializations of H and F . This was the easy part of the proofs of Theorem 1 and Corollary 2. Part (3) of Proposition 4 will be used in the proof of Theorem 3.

3 SPACES OF WEIGHT SYSTEMS

We recall the following from [BN1]. A *trivalent diagram* is an unoriented graph with $\ell \geq 1$ disjointly embedded oriented circles such that every connected component of this graph contains at least one oriented circle, every vertex has valency three, and the vertices that do not lie on an oriented circle have a cyclic orientation. We consider trivalent diagrams up to homeomorphisms of graphs that respect the additional data. The degree of a trivalent diagram is defined as half of the number of its vertices. An example of a diagram on two circles of degree 8 is shown in Figure 2.

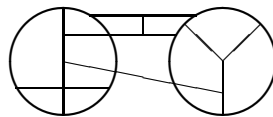

Figure 2: A trivalent diagram

In the picture the distinguished circles are drawn with thicker lines than the remaining part of the diagrams. Orientation of circles and vertices are assumed to be counterclockwise. Crossings in the picture do not correspond to vertices of a trivalent diagram. Let $\mathcal{A}_{n,\ell}$ be the \mathbb{Q} -vector space generated by trivalent diagrams of degree n on ℓ oriented circles together with the relations (STU), (IHX) and (AS) shown in Figure 3.

The diagrams in a relation are assumed to coincide everywhere except for the parts we have shown. Let $\bar{\mathcal{A}}_{n,\ell}$ be the quotient of $\mathcal{A}_{n,\ell}$ by the relation (FI), also shown in Figure 3. A *weight system* is a linear map from $\bar{\mathcal{A}}_{n,\ell}$ to a \mathbb{Q} -vector space.

A *chord diagram* is a trivalent diagram where every trivalent vertex lies on an oriented circle. It is easy to see that $\mathcal{A}_{n,\ell}$ is spanned by chord diagrams. If D is a chord diagram of degree n on ℓ oriented circles, then one can construct a singular link L_D with ℓ components such that the preimages of double points

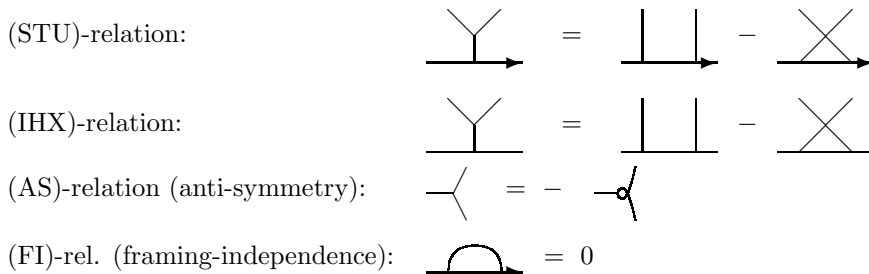

Figure 3: (STU), (IHX), (AS) and (FI)-relation

of L_D correspond to the points of D connected by a chord. The singular link L_D described above is not uniquely determined by D , but, if $v \in \mathcal{V}_{n,\ell}$, then the linear map $W(v) : \bar{\mathcal{A}}_{n,\ell} \rightarrow \mathbb{Q}$ which sends D to $v(L_D)$ is well-defined. This defines a linear map $W : \mathcal{V}_{n,\ell} \rightarrow \text{Hom}(\bar{\mathcal{A}}_{n,\ell}, \mathbb{Q}) = \bar{\mathcal{A}}_{n,\ell}^*$. Let us define the spaces

$$\mathcal{H}'_{n,\ell} = W(\mathcal{H}_{n,\ell}) \quad \text{and} \quad \mathcal{F}'_{n,\ell} = W(\mathcal{F}_{n,\ell}) \subseteq \bar{\mathcal{A}}_{n,\ell}^*.$$

If $v_1 \in \mathcal{V}_{n,\ell}$ and $v_2 \in \mathcal{V}_{m,\ell}$, then the link invariant $v_1 v_2$ defined by $(v_1 v_2)(L) = v_1(L) v_2(L)$ is in $\mathcal{V}_{n+m,\ell}$. Weight systems are multiplied by using the algebra structure dual to the coalgebra structure of $\bigoplus_{n=0}^{\infty} \bar{\mathcal{A}}_{n,\ell}$ (see [BN1]). The following proposition is a well-known consequence of a theorem of Kontsevich (see Proposition 2.9 of [BNG] and Theorem 7.2 of [KaT], Theorem 10 of [LM3] or [LM1], [LM2]).

PROPOSITION 5. *For all $\ell \geq 1$ there exists an isomorphism of algebras*

$$Z^* : \bigoplus_{n=0}^{\infty} \bar{\mathcal{A}}_{n,\ell}^* \longrightarrow \bigcup_{n=0}^{\infty} \mathcal{V}_{n,\ell}$$

such that for all $n \geq 0$ we have

$$Z^* \circ W|_{(\mathcal{H}_{n,\ell} + \mathcal{F}_{n,\ell})} = \text{id}_{(\mathcal{H}_{n,\ell} + \mathcal{F}_{n,\ell})}.$$

This proposition reduces the study of $\mathcal{H}_{n,\ell}$ and $\mathcal{F}_{n,\ell}$ to that of $\mathcal{H}'_{n,\ell}$ and $\mathcal{F}'_{n,\ell}$: we have the following corollary.

COROLLARY 6. *For all $n \geq 0$ and $\ell \geq 1$ we have*

$$\begin{aligned} \dim \mathcal{H}'_{n,\ell} &= \dim \mathcal{H}_{n,\ell}, \\ \dim \mathcal{F}'_{n,\ell} &= \dim \mathcal{F}_{n,\ell}, \\ \dim(\mathcal{H}'_{n,\ell} + \mathcal{F}'_{n,\ell}) &= \dim(\mathcal{H}_{n,\ell} + \mathcal{F}_{n,\ell}). \end{aligned}$$

We will often use Corollary 6 without referring to it.

4 UPPER BOUNDS FOR $\dim \mathcal{H}'_{n,\ell}$ AND $\dim \mathcal{F}'_{n,\ell}$

Let us recall the explicit descriptions of $W(p_{i,j}^\ell)$ and $W(q_{i,j}^\ell)$ from [BN1]. Let D be a trivalent diagram. Cut it into pieces along small circles around each vertex. Then replace the simple parts as shown in Figure 4.

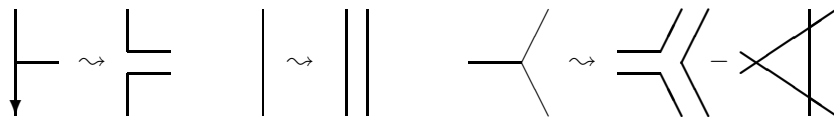

Figure 4: The map W_{gt}

Glue the substituted parts together. Sums of parts of diagrams are glued together after multilinear expansion. The result is a linear combination of unions of circles. Replace each circle by a formal parameter c and call the resulting polynomial $W_{gt}(D)$. It is well-known that this procedure determines a linear map $W_{gt} : \mathcal{A}_{n,\ell} \rightarrow \mathbb{Q}[c]$ (see [BN1], Exercise 6.36). Proceeding with the replacement patterns shown in Figure 5, we get the linear map $W_{so} : \mathcal{A}_{n,\ell} \rightarrow \mathbb{Q}[c]$.



Figure 5: The map W_{so}

For a trivalent diagram D , define the linear combination of trivalent diagrams $\iota(D)$ by replacing each chord as shown in Figure 6. Connected components of $D \setminus S^{1\text{II}\ell}$ with an internal trivalent vertex stay as they are.

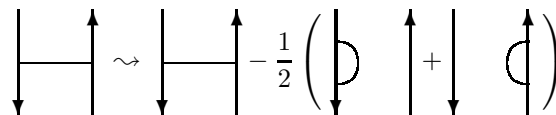

Figure 6: The deframing map ι

This definition determines a linear map $\iota : \bar{\mathcal{A}}_{n,\ell} \rightarrow \mathcal{A}_{n,\ell}$, such that $\pi \circ \iota = \text{id}$ where $\pi : \mathcal{A}_{n,\ell} \rightarrow \bar{\mathcal{A}}_{n,\ell}$ denotes the canonical projection (compare [BN1],

Exercise 3.16). By the following proposition ([BN1], Chapter 6.3) the weight systems $\overline{W}_{\mathfrak{gl}} = W_{\mathfrak{gl}} \circ \iota$ and $\overline{W}_{\mathfrak{so}} = W_{\mathfrak{so}} \circ \iota$ belong to the Homfly and Kauffman polynomials.

PROPOSITION 7. For all $n \geq 0, i, \ell \geq 1$ the weight system $W(p_{i,n}^\ell)$ (resp. $W(q_{i,n}^\ell)$) is equal to the coefficient of c^i in $\overline{W}_{\mathfrak{gl}|\overline{\mathcal{A}}_{n,\ell}}$ (resp. $\overline{W}_{\mathfrak{so}|\overline{\mathcal{A}}_{n,\ell}}$).

The direct description of $W(p_{i,n}^\ell)$ and $W(q_{i,n}^\ell)$ from the proposition above will simplify the computation of dimensions.

LEMMA 8. (1) For all $n, \ell \geq 1$ we have

$$\dim \mathcal{H}'_{n,\ell} \leq \begin{cases} n & \text{if } n < \ell, \\ \lceil \frac{n-1+\ell}{2} \rceil & \text{if } n \geq \ell. \end{cases}$$

(2) For all $n, \ell \geq 1$ we have

$$\dim \mathcal{F}'_{n,\ell} \leq \begin{cases} n-1 & \text{if } \ell = 1, \\ 2n-1 & \text{if } \ell \geq 2 \text{ and } n \leq \ell, \\ n+\ell-1 & \text{if } \ell \geq 2 \text{ and } n \geq \ell. \end{cases}$$

Proof. In the proof D will denote a chord diagram of degree $n \geq 1$ on ℓ circles. (1) If $n \geq \ell$, then we get $\lceil (n-1+\ell)/2 \rceil$ as an upper bound for $\dim \mathcal{H}'_{n,\ell}$ by the following observations:

- (a) The polynomial $\overline{W}_{\mathfrak{gl}}(D)$ has degree $\leq n + \ell$ and vanishing constant term because the number of circles can at most increase by one with each replacement of a chord as shown in Figure 4, and there remains always at least one circle.
- (b) The coefficients of $c^{n+\ell-1-2i}$ ($i = 0, 1, \dots$) vanish because the number of circles changes by ± 1 with each replacement of a chord as shown in Figure 4.
- (c) We have $\overline{W}_{\mathfrak{gl}}(D)(1) = 0$ because $W_{\mathfrak{gl}}(D')(1) = 1$ for each chord diagram D' and $\iota(D)$ is a linear combination of chord diagrams D' having 0 as sum of their coefficients.

If D is a chord diagram of degree $n < \ell$, then by similar arguments $\overline{W}_{\mathfrak{gl}}(D)$ is a linear combination of $c^{\ell-n}, c^{\ell-n+2}, \dots, c^{\ell+n}$ with $\overline{W}_{\mathfrak{gl}}(D)(1) = 0$. This implies the upper bound for $\dim \mathcal{H}'_{n,\ell}$.

(2) If $n \geq \ell$, then by the same arguments as above $\overline{W}_{\mathfrak{so}}(D)$ is a polynomial of degree $\leq n + \ell$ with vanishing constant term and $\overline{W}_{\mathfrak{so}}(D)(1) = 0$. This implies $\dim \mathcal{F}'_{n,\ell} \leq n + \ell - 1$ in this case.

If $\ell = 1$, then for chord diagrams D' of degree n the value $W_{\mathfrak{so}}(D')(2)$ is constant because \mathfrak{so}_2 is an abelian Lie algebra (see [BN1]). This implies $\overline{W}_{\mathfrak{so}}(D)(2) = 0$ and hence $\dim \mathcal{F}'_{n,\ell} \leq n - 1$ in this case.

If $\ell \geq 2$ and $n < \ell$, then the coefficient of $c^{\ell-n}$ in $\overline{W}_{\mathfrak{so}}(D)$ is 0 by the following argument: Assume that a chord diagram D' has the minimal possible number of $\ell - n$ connected components (in other words, if we contract the oriented circles of D' to points, then the resulting graph is a forest). Then we see that $W_{\mathfrak{so}}(D') = 0$ by using Figure 5. Hence $\overline{W}_{\mathfrak{so}}(D)$ is a linear combination of

$c^{\ell-n+1}, c^{\ell-n+2}, \dots, c^{\ell+n}$ with $\overline{W}_{\text{so}}(D)(1) = 0$. This completes the proof of the upper bounds for $\dim \mathcal{F}'_{n,\ell}$. \square

5 THE BRAUER ALGEBRA AND VALUES OF \overline{W}_{gl} AND \overline{W}_{so}

In order to find lower bounds for $\dim \mathcal{H}'_{n,\ell}$, $\dim \mathcal{F}'_{n,\ell}$ and $\dim(\mathcal{H}'_{n,\ell} + \mathcal{F}'_{n,\ell})$, we shall evaluate the weight systems \overline{W}_{gl} and \overline{W}_{so} on sufficiently many trivalent diagrams. Let ω_k, L_k, C_k, T_k be the diagrams of degree k shown in Figure 7.

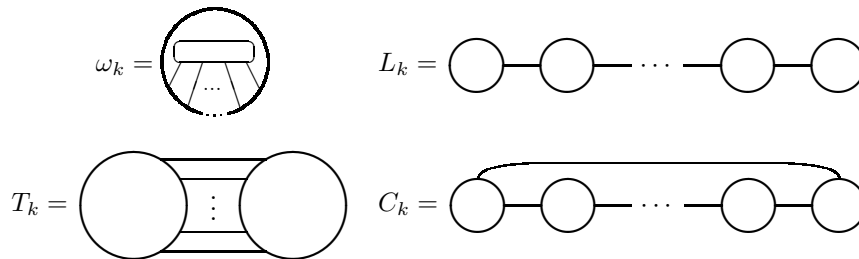

Figure 7: The diagrams ω_k, L_k, C_k, T_k

For technical reasons we extend this definition by setting $L_0 = C_0 = T_0 = S^1$ and $C_1 = L_1$. An important ingredient in the proofs of Theorems 1 and 3 is the following lemma.

LEMMA 9. (1) For all $k \geq 2$ we have

$$\begin{aligned} \overline{W}_{\text{gl}}(\omega_k) &= \begin{cases} c^{k+1} + c^3 - 2c & \text{if } k \text{ is even,} \\ c^{k+1} - c^2 & \text{if } k \text{ is odd, and} \end{cases} \\ \overline{W}_{\text{so}}(\omega_k) &= c(c-1)(c-2)R_k(c), \end{aligned}$$

where R_k is a polynomial with $R_k(0) \neq 0$. If $k = 2$, then $R_2 = 2$, and if $k \neq 3$, then $R_k(2) \neq 0$.

(2) For all $k \geq 1$ we have

$$\begin{aligned} \overline{W}_{\text{gl}}(L_k) &= c(1 - c^2)^k, & \overline{W}_{\text{so}}(L_k) &= c^{k+1}(1 - c)^k, \\ \overline{W}_{\text{gl}}(T_k) &= (-c)^k(c^2 - 1), & \overline{W}_{\text{so}}(T_k) &= c(c-1)Q_k(c), \\ & & \overline{W}_{\text{so}}(C_k) &= c(c-1)P_k(c), \end{aligned}$$

where P_k and Q_k are polynomials in c such that for $k \geq 2$ we have $P_k(0) \neq 0$, $Q_k(0) = 2^{k-1}$, and $Q_k(2) = (-2)^k$.

In the proof of the lemma we will determine the polynomials P_k , Q_k , and R_k explicitly, which will be helpful to us for calculations in low degrees. For the main parts of the proofs of Theorems 1 and 3 it will be sufficient to know the properties of these polynomials stated in the lemma. We do not need to know the value of $\overline{W}_{\text{gl}}(C_k)$.

In the proof of Lemma 9 we use the Brauer algebra ([Bra]) on k strands \mathbf{Br}_k . As a $\mathbb{Q}[c]$ -module \mathbf{Br}_k has a basis in one-to-one correspondence with involutions without fixed-points of the set $\{1, \dots, k\} \times \{0, 1\}$. We represent a basis element corresponding to an involution f graphically by connecting the points (i, j) and $f(i, j)$ by a curve in $\mathbb{R} \times [0, 1]$. Examples are the diagrams $u_-, x_+, x_-, u_+ = d, e, f, g, h$ in Figures 8 and 9.

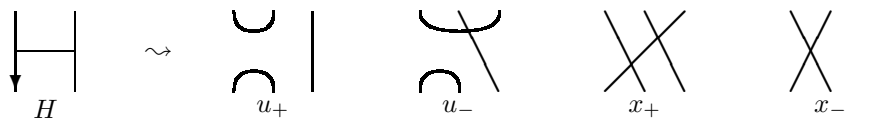

Figure 8: Elements of \mathbf{Br}_3 needed to calculate $W_{\text{so}}(\omega_k)$

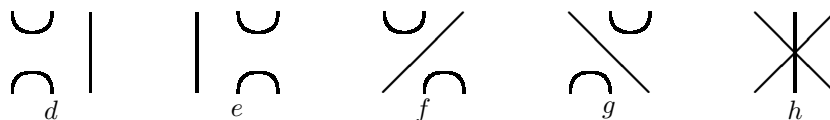

Figure 9: Diagrams needed to calculate $W_{\text{gl}}(\omega_k)$

The product of basis vectors a and b is defined graphically by placing a onto the top of b , by gluing the lower points $(i, 0)$ of a to the upper points $(i, 1)$ of b , and by introducing the relation that a circle is equal to the formal parameter c of the ground ring $\mathbb{Q}[c]$. We have a map $\text{tr} : \mathbf{Br}_k \rightarrow \mathbb{Q}[c]$, called trace, that is defined graphically by connecting the vertices $(i, 0)$ and $(i, 1)$ of a diagram by curves, and by replacing each circle by the indeterminate c . As an example, the trace of the diagram x_+u_- is shown in Figure 10.

$$\text{tr} \left(\begin{array}{c} \diagup \quad \cup \\ \diagdown \quad \cup \end{array} \right) = \text{tr} \left(\text{circle} \right) = c$$

Figure 10: The trace of a diagram

The elements u_+, u_-, x_+, x_- arise among others when the replacement rules belonging to W_{so} (see Figure 5) are applied to the part H (see Figure 8) of a trivalent diagram. Similarly, the elements d and h arise when we apply the replacement rules belonging to W_{gl} (see Figure 4) to the part H of a trivalent diagram. We have $\iota(\omega_k) = \omega_k$ (see Figure 6) because the diagram ω_k contains no chords. The proof of the following lemma is now straightforward.

LEMMA 10. *The following two formulas hold:*

$$\overline{W}_{gl}(\omega_k) = \text{tr}((d - h)^k) \quad \text{and} \quad \overline{W}_{so}(\omega_k) = \text{tr}((u_+ - u_- + x_+ - x_-)^k).$$

Now we can prove Lemma 9 by making calculations in the Brauer algebra.

Proof of Lemma 9. (1) With the elements $u_{\pm}, x_{\pm} \in \mathbf{Br}_3$ shown in Figure 8 we define $u = u_+ - u_-$ and $x = x_+ - x_-$. It is easy to verify that

$$(u + x)u = (c - 2)u \text{ and } x^3 = x^2 + 2x. \tag{12}$$

In view of the expression for x^3 it is clear that x^k can be expressed as a linear combination of x and x^2 :

$$d_k x^2 + e_k x = x^k. \tag{13}$$

It can be shown by induction that the sequence of pairs $(d_k, e_k)_{k \geq 1}$ is given by $(d_1, e_1) = (0, 1)$ and $(d_{k+1}, e_{k+1}) = (d_k + e_k, 2d_k)$. We deduce

$$\begin{aligned} d_1 - e_1 &= -1, d_{k+1} - e_{k+1} = d_k + e_k - 2d_k = e_k - d_k \\ \Rightarrow d_k - e_k &= (-1)^k, \end{aligned} \tag{14}$$

$$d_{k+1} + (-1)^k = (d_k + e_k) + (d_k - e_k) = 2d_k. \tag{15}$$

By Equations (12) and (13) we have

$$\begin{aligned} (u + x)^k &= x^k + \sum_{i=0}^{k-1} (u + x)^i u x^{k-i-1} \\ &= d_k x^2 + e_k x + (c - 2)^{k-1} u + \sum_{i=0}^{k-2} (c - 2)^i (d_{k-i-1} u x^2 + e_{k-i-1} u x). \end{aligned} \tag{16}$$

It is easy to see that

$$\text{tr}(x^2)/(c - 1) = -\text{tr}(x) = \text{tr}(u) = -\text{tr}(ux) = \text{tr}(ux^2) = c^2 - c. \tag{17}$$

Applying the trace to Equation (16) yields by Lemma 10 and Equations (14) and (17):

$$\begin{aligned} & \overline{W}_{\mathfrak{so}}(\omega_k) \\ = & (c^2 - c) \left[d_k(c-1) - e_k + (c-2)^{k-1} + \sum_{i=0}^{k-2} (c-2)^i (d_{k-i-1} - e_{k-i-1}) \right] \\ = & (c^2 - c) \left[d_k(c-2) + (-1)^k - \sum_{i=0}^{k-1} (-1)^{k-i} (c-2)^i \right] \\ = & (c^2 - c)(c-2) \left[(d_k + (-1)^k) + \sum_{i=1}^{k-2} (-1)^{k-i} (c-2)^i \right]. \end{aligned}$$

Define the sequence $(a_k)_{k \geq 2}$ inductively by $a_2 = 2$ and $a_{k+1} = 2a_k - 4(-1)^k$. We have $a_2 = d_2 + (-1)^2$ and by definition of a_k , induction and Equation (15) also

$$a_{k+1} = 2a_k - 4(-1)^k = 2(d_k + (-1)^k) - 4(-1)^k = d_{k+1} + (-1)^{k+1}.$$

This implies $\overline{W}_{\mathfrak{so}}(\omega_k) = c(c-1)(c-2)R_k(c)$ with

$$R_k(c) = a_k + \sum_{i=1}^{k-2} (-1)^{k-i} (c-2)^i.$$

The properties of R_k stated in the lemma are satisfied because by a simple computation we have $R_k(2) = a_k > 0$ for $k \neq 3$ and

$$R_k(0) = a_k + (-1)^k (2^{k-1} - 2) \equiv 2 \pmod{4}.$$

We only give a sketch of the proof of the formula for $\overline{W}_{\mathfrak{gl}}(\omega_k)$. Let d, e, f, g, h be the elements of \mathbf{Br}_3 shown in Figure 9. Then one can prove by induction on k that

$$(d-h)^{2k+1} = c^{2k}d - h + \sum_{i=0}^{k-1} c^{2i}(d+e) - c^{2i+1}(f+g).$$

Using Lemma 10 this formula allows to conclude by distinguishing whether k is even or odd.

(2) Let $a, b, \mathbf{1}$ be the elements of \mathbf{Br}_2 shown in Figure 11.

Then we have $ab = ba = a$, $a^2 = ca$, $b^2 = \mathbf{1}$, $\text{tr}(a) = \text{tr}(b) = c$, $\text{tr}(\mathbf{1}) = c^2$, and by convention $(a-b)^0 = \mathbf{1}$. This implies for $k \geq 1$ that

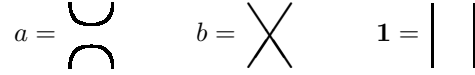

Figure 11: Diagrams in \mathbf{Br}_2

$$\begin{aligned}
 \overline{W}_{\mathfrak{so}}(T_k) &= \text{tr}((a - b + \mathbf{1} - c\mathbf{1})^k) \\
 &= \text{tr} \left[\sum_{i=0}^k \binom{k}{i} (1-c)^{k-i} (a-b)^i \right] \\
 &= \text{tr} \left\{ \sum_{i=0}^k \binom{k}{i} (1-c)^{k-i} \left[(-b)^i + \sum_{j=1}^i \binom{i}{j} c^{j-1} (-1)^{i-j} a \right] \right\} \\
 &= \sum_{i=0}^k \binom{k}{i} (1-c)^{k-i} [\text{tr}((-b)^i) + (c-1)^i - (-1)^i] \\
 &= \sum_{i=0}^k \binom{k}{i} (1-c)^{k-i} [\text{tr}((-b)^i) - (-1)^i] \\
 &= \sum_{\substack{0 \leq i \leq k \\ i \text{ even}}} \binom{k}{i} (1-c)^{k-i} (c^2 - 1) + \sum_{\substack{1 \leq i \leq k \\ i \text{ odd}}} \binom{k}{i} (1-c)^{k-i} (1-c) \\
 &= \sum_{i=0}^k \binom{k}{i} (1-c)^{k-i} (c-1)(-1)^i + c \sum_{\substack{0 \leq i \leq k \\ i \text{ even}}} \binom{k}{i} (1-c)^{k-i} (c-1) \\
 &= c(c-1) \left[-(-c)^{k-1} + \sum_{\substack{0 \leq i \leq k \\ i \text{ even}}} \binom{k}{i} (1-c)^{k-i} \right].
 \end{aligned}$$

Now one checks the properties of Q_k using the last expression for $\overline{W}_{\mathfrak{so}}(T_k)$. The remaining formulas follow by easy computations. For example, $\overline{W}_{\mathfrak{so}}(L_k)$ is given by the value of $W_{\mathfrak{so}}$ on the diagrams in $\iota(L_k)$ where no chord connects two different circles. Furthermore, one can show for $k \geq 2$ that

$$\overline{W}_{\mathfrak{so}}(C_k) = \text{tr}((\mathbf{1} - b)^k) + (1-c)\overline{W}_{\mathfrak{so}}(L_{k-1}) = c(c-1) (2^{k-1} - c^{k-1}(1-c)^{k-1}).$$

The property $P_k(0) \neq 0$ from the lemma is obvious from the formula above. \square

6 COMPLETION OF PROOFS USING VOGEL'S ALGEBRA

In the case of diagrams on one oriented circle, the coalgebra structure of $\overline{\mathcal{A}} = \bigoplus_{n=0}^{\infty} \overline{\mathcal{A}}_n$ can be extended to a Hopf algebra structure (see [BN1]). The

primitive elements \mathcal{P} of $\bar{\mathcal{A}}$ are spanned by diagrams D such that $D \setminus S^1$ is connected, where S^1 denotes the oriented circle of D . Vogel defined an algebra Λ which acts on primitive elements (see [Vog]). The diagrams t and x_3 shown in Figure 12 represent elements of Λ .

$$t = \text{---} \text{---} \text{---} \text{---} \text{---} \text{---} \quad x_3 = \text{---} \text{---} \text{---} \text{---} \text{---} \text{---}$$

Figure 12: Elements of Λ

The space of primitive elements \mathcal{P} of $\bar{\mathcal{A}}$ becomes a Λ -module by inserting an element of Λ into a freely chosen trivalent vertex of a diagram of a primitive element. Multiplication by t increases the degree by 1 and multiplication by x_3 increases the degree by 3. An example is shown in Figure 13.

$$x_3 \omega_4 = x_3 \text{---} \text{---} \text{---} \text{---} \text{---} \text{---} = \text{---} \text{---} \text{---} \text{---} \text{---} \text{---}$$

Figure 13: How \mathcal{P} becomes a Λ -module

If D and D' are classes of trivalent diagrams with a distinguished oriented circle modulo (STU)-relations (see Figure 3), then their connected sum $D\#D'$ along these circles is well defined. We state in the following lemma how the weight systems \bar{W}_{gl} and \bar{W}_{so} behave under the operations described above: Part (1) of the lemma is easy to prove; for Part (2), see Theorem 6.4 and Theorem 6.7 of [Vog].

LEMMA 11. (1) Let D and D' be chord diagrams each one having a distinguished oriented circle. Then the connected sum of D and D' satisfies

$$\bar{W}_{\text{gl}}(D\#D') = \bar{W}_{\text{gl}}(D)\bar{W}_{\text{gl}}(D')/c \quad \text{and} \quad \bar{W}_{\text{so}}(D\#D') = \bar{W}_{\text{so}}(D)\bar{W}_{\text{so}}(D')/c.$$

(2) For a primitive element $p \in \mathcal{P}$ we have:

$$\begin{aligned} \bar{W}_{\text{gl}}(tp) &= c\bar{W}_{\text{gl}}(p), \\ \bar{W}_{\text{so}}(tp) &= \tilde{c}\bar{W}_{\text{so}}(p), \\ \bar{W}_{\text{gl}}(x_3p) &= (c^3 + 12c)\bar{W}_{\text{gl}}(p), \\ \bar{W}_{\text{so}}(x_3p) &= (\tilde{c}^3 - 3\tilde{c}^2 + 30\tilde{c} - 24)\bar{W}_{\text{so}}(p), \end{aligned}$$

where $\tilde{c} = c - 2$.

We have the following formulas concerning spaces of weight systems restricted to primitive elements.

PROPOSITION 12. For the restrictions of the weight systems to primitive elements of degree $n \geq 1$ we have

- (1) $\dim \mathcal{H}'_{n|\mathcal{P}_n} = \dim \mathcal{H}'_n = [n/2],$
- (2) $\dim \mathcal{F}'_{n|\mathcal{P}_n} = \max(n - 2, [n/2]) = \begin{cases} [n/2] & \text{if } n \leq 3, \\ n - 2 & \text{if } n \geq 3, \end{cases}$
- (3) $\dim (\mathcal{H}'_{n|\mathcal{P}_n} \cap \mathcal{F}'_{n|\mathcal{P}_n}) = \min(2, [n/2]) = \begin{cases} [n/2] & \text{if } n \leq 3, \\ 2 & \text{if } n \geq 4. \end{cases}$

The proof of Proposition 12 will be given in this section together with a proof of Theorem 1. The proof is divided into several steps.

If q is a polynomial, then we denote the degree of its lowest degree term by $\text{ord}(q)$. Now we start to derive lower bounds for dimensions of spaces of weight systems.

Proof of Part (1) of Proposition 12. By Lemma 9 we have $\text{ord}(\overline{W}_{\mathfrak{gl}}(\omega_k)) = 1$ for even k . By Lemma 11 we have $\overline{W}_{\mathfrak{gl}}(t^k p) = c^k \overline{W}_{\mathfrak{gl}}(p)$ for $p \in \mathcal{P}$. This implies

$$\dim \left(\overline{W}_{\mathfrak{gl}} \left(\text{span} \{ t^{n-2} \omega_2, t^{n-4} \omega_4, \dots, t^{n-2[n/2]} \omega_{2[n/2]} \} \right) \right) = [n/2] \leq \dim \mathcal{H}'_{n|\mathcal{P}_n}.$$

Since this lower bound coincides with the upper bound from Lemma 8 we have $\dim \mathcal{H}'_{n|\mathcal{P}_n} = [n/2]$. □

Let $D_{ijk} = (L_i \# C_j) \# T_k$ (in this definition we choose arbitrary distinguished circles of $L_i, C_j, (L_i \# C_j)$ and for further use also for D_{ijk}). Let d_{ijk} be the number of oriented circles in D_{ijk} and define $D_{i,j,k}^\ell = D_{ijk} \amalg S^{1 \amalg (\ell - d_{ijk})}$ for $\ell \geq d_{ijk}$. We will make use of the formulas for $\overline{W}_{\mathfrak{gl}}(D_{i,0,k}^\ell \# \omega_m)$ and $\overline{W}_{\mathfrak{so}}(D_{i,j,k}^\ell \# \omega_m)$ implied by Lemmas 9 and 11 throughout the rest of this section.

Proof of Part (1) of Theorem 1. For all $n \geq 1$ we have $[n/2]$ primitive elements p_i such that the polynomials $g_i = \overline{W}_{\mathfrak{gl}}(p_i \amalg S^{1 \amalg (\ell - 1)})$ are linearly independent and $c^\ell |g_i$ (see the proof of Part (1) of Proposition 12). Let $n < \ell$. The diagrams

$$D_{n,0,0}^\ell, D_{n-2,0,0}^\ell \# \omega_2, \dots, D_{n-2[(n-1)/2],0,0}^\ell \# \omega_{2[(n-1)/2]} \tag{18}$$

are mapped by $\overline{W}_{\mathfrak{gl}}$ to the values

$$c^{\ell-n} (1 - c^2)^n, c^{\ell-n+2} f_2(c), \dots, c^{\ell-1} f_{[(n+1)/2]}(c)$$

with polynomials f_i satisfying $f_i(0) = -2$ ($i = 2, \dots, [(n + 1)/2]$). So in this case we have found $[n/2] + [(n + 1)/2] = n$ linearly independent values, which

is the maximal possible number (see Lemma 8). If $n \geq \ell$, then we conclude in the same way using the following list of $k - n + 1 + \lfloor (n - 1)/2 \rfloor = k - \lfloor n/2 \rfloor$ elements where $k = \lfloor (n + \ell - 1)/2 \rfloor$:

$$D_{2k-n,0,0}^\ell \# \omega_{2n-2k}, D_{2k-n-2,0,0}^\ell \# \omega_{2n-2k+2}, \dots, D_{n-2\lfloor (n-1)/2 \rfloor,0,0}^\ell \# \omega_{2\lfloor (n-1)/2 \rfloor}. \tag{19}$$

□

We will use the upper bounds for $\dim \mathcal{H}'_{n,\ell}$ and $\dim \mathcal{F}'_{n,\ell}$ together with the following lower bound for $\dim(\mathcal{H}'_{n,\ell} \cap \mathcal{F}'_{n,\ell})$ to get an upper bound for $\dim(\mathcal{H}'_{n,\ell} + \mathcal{F}'_{n,\ell})$. In the case $\ell = 1$ we will argue in a similar way for the restriction of weight systems to primitive elements.

LEMMA 13. *For all $n, \ell \geq 1$ we have*

$$\begin{aligned} \dim(\mathcal{H}'_{n,\ell} \cap \mathcal{F}'_{n,\ell}) &\geq \min(\dim \mathcal{H}'_{n,\ell}, 2) \\ &= \min(n, \lfloor (n - 1 + \ell)/2 \rfloor, 2) = \dim(\text{span}\{W(r_n^\ell), W(y_n^\ell)\}). \end{aligned}$$

For all $n \geq 1$ we have

$$\dim(\mathcal{H}'_{n|\mathcal{P}_n} \cap \mathcal{F}'_{n|\mathcal{P}_n}) \geq \min(\dim \mathcal{H}'_n, 2) = \min(\lfloor n/2 \rfloor, 2).$$

Proof. Propositions 4 and 7 imply that the weight system $W(r_n^\ell) \in \mathcal{H}'_{n,\ell} \cap \mathcal{F}'_{n,\ell}$ is equal to $(-1)^\ell \overline{W}_{\mathfrak{gl}(\cdot)}(2)|_{\overline{\mathcal{A}}_{n,\ell}}$ and the weight system $W(y_n^\ell) \in \mathcal{H}'_{n,\ell} \cap \mathcal{F}'_{n,\ell}$ is equal to the coefficient of $c^{\ell+n}$ in $\overline{W}_{\mathfrak{gl}(\cdot)}|_{\overline{\mathcal{A}}_{n,\ell}}$. By the proof of Lemma 8 we have $\overline{W}_{\mathfrak{gl}(D)}(0) = \overline{W}_{\mathfrak{gl}(D)}(1) = 0$ and in the weight system $\overline{W}_{\mathfrak{gl}(\cdot)}|_{\overline{\mathcal{A}}_{n,\ell}}$ the coefficients of $c^{\ell+n-1}, c^{\ell+n-3}, \dots$ and the coefficients of $c^{\ell-n-1}, c^{\ell-n-2}, \dots$ vanish. By Part (1) of Theorem 1 these are the only linear dependencies between the coefficients of $c^{\ell+n}, c^{\ell+n-1}, \dots$ in the polynomial $\overline{W}_{\mathfrak{gl}(\cdot)}|_{\overline{\mathcal{A}}_{n,\ell}}$. This implies for $\dim \mathcal{H}'_{n,\ell} = 1$ that the coefficient of $c^{\ell+n}$ in $\overline{W}_{\mathfrak{gl}(\cdot)}|_{\overline{\mathcal{A}}_{n,\ell}}$ is not the trivial weight system and this implies for $\dim \mathcal{H}'_{n,\ell} \geq 2$ that $\overline{W}_{\mathfrak{gl}(\cdot)}(2)|_{\overline{\mathcal{A}}_{n,\ell}}$ and the coefficient of $c^{\ell+n}$ in $\overline{W}_{\mathfrak{gl}(\cdot)}|_{\overline{\mathcal{A}}_{n,\ell}}$ are linearly independent. By Part (1) of Proposition 12 we can argue in the same way with $\overline{W}_{\mathfrak{gl}(\cdot)}|_{\mathcal{P}_n}$. This completes the proof. □

Define the weight system $w = (-2)^n \overline{W}_{\mathfrak{so}(\cdot)}(4) - 2(-2)^\ell \overline{W}_{\mathfrak{so}(\cdot)}(-2) \in \mathcal{F}'_{n,\ell}$. For $n \geq 4$ Lemmas 9 and 11 imply that

$$w \left(\omega_2 \# (t^{n-4} \omega_2) \amalg S^{1 \amalg \ell-1} \right) = 18(-4)^n 4^{\ell-1} \neq 0. \tag{20}$$

Part (3) of Proposition 4 together with Propositions 5 and 7 implies that

$$0 \neq w \in \bigoplus_{i=1}^{n-1} \mathcal{F}'_{i,\ell} \mathcal{F}'_{n-i,\ell}. \tag{21}$$

For $\ell = 1$ Equation (21) implies $w(\mathcal{P}_n) = 0$. Therefore we have

$$\dim \mathcal{F}'_{n|\mathcal{P}_n} \leq \dim \mathcal{F}'_n - 1 \leq n - 2 \quad \text{for all } n \geq 4. \tag{22}$$

Since we have $\dim \mathcal{H}'_n = \dim \mathcal{H}'_{n|\mathcal{P}_n}$ by Part (1) of Proposition 12 we know that $w \notin \mathcal{H}'_n$ and therefore

$$\dim(\mathcal{H}'_n + \mathcal{F}'_n) \geq \dim(\mathcal{H}'_n + \mathcal{F}'_n)_{|\mathcal{P}_n} + 1 \quad \text{for all } n \geq 4. \tag{23}$$

Let $(\overline{W}_{\text{gl}}, \overline{W}_{\text{so}}) : \overline{\mathcal{A}}_{n,\ell} \rightarrow \mathbb{Q}[c] \times \mathbb{Q}[c]$ be defined by

$$(\overline{W}_{\text{gl}}, \overline{W}_{\text{so}})(D) = (\overline{W}_{\text{gl}}(D), \overline{W}_{\text{so}}(D)).$$

Then by Proposition 7 we have

$$\dim(\mathcal{H}'_{n,\ell} + \mathcal{F}'_{n,\ell}) = \dim((\overline{W}_{\text{gl}}, \overline{W}_{\text{so}})(\overline{\mathcal{A}}_{n,\ell})), \tag{24}$$

$$\dim(\mathcal{H}'_{n|\mathcal{P}_n} + \mathcal{F}'_{n|\mathcal{P}_n}) = \dim((\mathcal{H}'_n + \mathcal{F}'_n)_{|\mathcal{P}_n}) = \dim((\overline{W}_{\text{gl}}, \overline{W}_{\text{so}})(\mathcal{P}_n)) \tag{25}$$

We will use Equations (24) and (25) to derive lower bounds for $\dim(\mathcal{H}'_{n,\ell} + \mathcal{F}'_{n,\ell})$ and for $\dim(\mathcal{H}'_n + \mathcal{F}'_n)_{|\mathcal{P}_n}$. Now we can complete the proofs of Theorem 1 and Proposition 12.

Proof of Parts (2) and (3) of Proposition 12 and Theorem 1 for $\ell = 1$. Let

$$\Sigma_7 = \text{span}\{\omega_7, t\omega_6, t^2\omega_5, t^3\omega_4, t^5\omega_2, x_3\omega_4\} \subset \mathcal{P}_7.$$

Define for $n > 7$:

$$\Sigma_n = \begin{cases} t\Sigma_{n-1} + \mathbb{Q}\omega_n & \text{if } n \text{ is odd,} \\ t\Sigma_{n-1} + \mathbb{Q}\omega_n + \mathbb{Q}x_3\omega_{n-3} & \text{if } n \text{ is even.} \end{cases}$$

By a calculation using Lemmas 9 and 11 we obtain

$$\dim((\overline{W}_{\text{gl}}, \overline{W}_{\text{so}})(\Sigma_7)) = 6.$$

In view of the proof of Lemma 8 we can define a polynomial-valued weight system by $\widetilde{W}_{\text{so}}(\cdot) = \overline{W}_{\text{so}}(\cdot)/(c(c-1))$. We used Lemma 9 and Lemma 11 to compute the degree 1 coefficients of the values of \overline{W}_{gl} and $\widetilde{W}_{\text{so}}$ on elements of Σ_n stated in Table 1.

	$t\Sigma_{n-1}$	ω_n (n odd)	ω_n (n even)	$x_3\omega_{n-3}$ (n even)
coeff. of \tilde{c} in $\widetilde{W}_{\text{so}}(\cdot)$:	0	$R_n(2)$	$R_n(2)$	$-24R_{n-3}(2)$
coeff. of c in $\widetilde{W}_{\text{gt}}(\cdot)$:	0	0	-2	0

Table 1: Degree 1 coefficients of $\widetilde{W}_{\text{gt}}$ and $\widetilde{W}_{\text{so}}$ on Σ_n

By Lemma 9 we have $R_k(2) \neq 0$ if $k \neq 3$. Then, by Table 1 and induction, we see that $\dim(\widetilde{W}_{\text{gt}}, \widetilde{W}_{\text{so}})(\Sigma_n) = [n/2] + n - 4$ for $n \geq 7$. By Equation (25), Lemmas 8 and 13, and Equation (22) we obtain

$$\begin{aligned} [n/2] + n - 4 + 2 &\leq \dim(\mathcal{H}'_{n|\mathcal{P}_n} + \mathcal{F}'_{n|\mathcal{P}_n}) + \dim(\mathcal{H}'_{n|\mathcal{P}_n} \cap \mathcal{F}'_{n|\mathcal{P}_n}) = \\ &= \dim \mathcal{H}'_{n|\mathcal{P}_n} + \dim \mathcal{F}'_{n|\mathcal{P}_n} \leq [n/2] + n - 2. \end{aligned}$$

Thus equality must hold. This implies Parts (2) and (3) of Proposition 12 for $n \geq 7$. By Equation (23) we get $\dim(\mathcal{H}'_n + \mathcal{F}'_n) \geq [n/2] + n - 3$. Now we see by Lemmas 8 and 13 that

$$\begin{aligned} [n/2] + n - 3 + 2 &\leq \dim(\mathcal{H}'_n + \mathcal{F}'_n) + \dim(\mathcal{H}'_n \cap \mathcal{F}'_n) = \\ &= \dim \mathcal{H}'_n + \dim \mathcal{F}'_n \leq [n/2] + n - 1 \end{aligned}$$

which implies Part (2) and Part (3) of Theorem 1 for $n \geq 7$ and $\ell = 1$. Let ψ be the element of degree 6 shown in Figure 14.

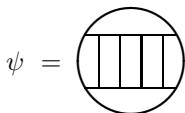

Figure 14: A primitive element in degree 6

A calculation done by computer yields

$$\begin{aligned} \widetilde{W}_{\text{gt}}(\psi) &= c^7 + 13c^5 - 14c^3, \\ \widetilde{W}_{\text{so}}(\psi) &= \tilde{c}^5 - 3\tilde{c}^4 + 34\tilde{c}^3 - 36\tilde{c}^2 + 16\tilde{c}. \end{aligned}$$

Let $\Sigma_4 = \text{span}\{\omega_4, t^2\omega_2\}$, $\Sigma_5 = t\Sigma_4 + \mathbb{Q}\omega_5$, and $\Sigma_6 = t\Sigma_5 + \mathbb{Q}\omega_6 + \mathbb{Q}\psi$. We obtain again $\dim(\widetilde{W}_{\text{gt}}, \widetilde{W}_{\text{so}})(\Sigma_n) = [n/2] + n - 4$ which implies Parts (2) and (3) of Proposition 12 and Theorem 1 for $\ell = 1$ and $n \geq 4$ by the same argument as before. In degrees $n = 1, 2, 3$ we have $\dim \mathcal{P}_n = \dim \bar{\mathcal{A}}_n = \dim \mathcal{H}'_n = \dim \mathcal{F}'_n = [n/2]$. This completes the proof. \square

Proof of Parts (2) and (3) of Theorem 1 for $\ell > 1$. Let $n \geq 4$ and $\ell > 1$. By the previous proof we have $n + [n/2] - 3$ elements $a_i \in \bar{\mathcal{A}}_n$ such that the values

$$(\overline{W}_{\mathfrak{gl}}(D_i), \overline{W}_{\mathfrak{so}}(D_i)) \in \mathbb{Q}[c] \times \mathbb{Q}[c]$$

of $D_i = a_i \amalg S^{1^{\amalg \ell-1}}$ are linearly independent. Consider the following lists of elements:

If $n \leq \ell$, then we take the n elements

$$D_{0,n,0}^\ell, D_{1,n-1,0}^\ell, \dots, D_{n-3,3,0}^\ell, D_{0,0,n}^\ell, E_n^\ell := D_{0,0,n}^\ell - D_{0,0,n-2}^\ell \# \omega_2 \quad (26)$$

If $n \geq \ell + 1$, then we take the ℓ elements

$$D_{0,\ell-1,n-\ell+1}^\ell, D_{1,\ell-2,n-\ell+1}^\ell, \dots, D_{\ell-3,2,n-\ell+1}^\ell, D_{0,0,n}^\ell, E_n^\ell. \quad (27)$$

Let $\mathcal{M}_{n,\ell}$ be the list of elements D_i together with the elements from Equation (18) (resp. (19)) and Equation (26) (resp. (27)). We have

$$\text{card}(\mathcal{M}_{n,\ell}) = \begin{cases} 3n - 3 & \text{if } n < \ell, \\ n + \ell - 3 + [(n + \ell - 1)/2] & \text{if } n \geq \ell. \end{cases} \quad (28)$$

The values of $\overline{W}_{\mathfrak{gl}}$ and $\overline{W}_{\mathfrak{so}}$ on elements of $\mathcal{M}_{n,\ell}$ have the properties stated in Table 2.

$\text{ord}(\overline{W}_{\mathfrak{gl}}(D_i)) \geq \ell$	$\text{ord}(\overline{W}_{\mathfrak{so}}(D_i)) \geq \ell, \overline{W}_{\mathfrak{so}}(D_i)(2) = 0$
$\text{ord}(\overline{W}_{\mathfrak{gl}}(E_n^\ell)) \geq \ell$	$\text{ord}(\overline{W}_{\mathfrak{so}}(E_n^\ell)) \geq \ell, \overline{W}_{\mathfrak{so}}(E_n^\ell)(2) \neq 0$
$\text{ord}(\overline{W}_{\mathfrak{gl}}(D_{i,0,0}^\ell \# \omega_{n-i})) = \ell - i$ ($i > 0, n - i$ even)	$\text{ord}(\overline{W}_{\mathfrak{so}}(D_{i,0,0}^\ell \# \omega_{n-i})) \geq \ell$
	$\text{ord}(\overline{W}_{\mathfrak{so}}(D_{n-i,i,0}^\ell)) = \ell + 1 - i$ ($i \geq 3$) $\text{ord}(\overline{W}_{\mathfrak{so}}(D_{i,\ell-1-i,n-\ell+1}^\ell)) = i + 1$ ($i \leq \ell - 3$) $\text{ord}(\overline{W}_{\mathfrak{so}}(D_{0,0,n}^\ell)) = \ell - 1$

Table 2: Properties of $\overline{W}_{\mathfrak{gl}}(e)$ and $\overline{W}_{\mathfrak{so}}(e)$ for $e \in \mathcal{M}_{n,\ell}$

The statements from this table are easily verified. For example, we have

$$\overline{W}_{\mathfrak{so}}(E_n^\ell) = c^{\ell-1}(c-1)h(c)$$

with $h(c) = Q_n(c) - 2(c-1)(c-2)Q_{n-2}(c)$. We have $h(0) = Q_n(0) - 4Q_{n-2}(0) = 0$ which implies

$$\text{ord}(\overline{W}_{\mathfrak{so}}(E_n^\ell)) \geq \ell,$$

and $h(2) = Q_n(2) = (-2)^n$ which implies $\overline{W}_{\text{so}}(E_n^\ell)(2) \neq 0$. Now let

$$f = \sum_{e \in \mathcal{M}_{n,\ell}} \lambda(e) (\overline{W}_{\text{gt}}(e), \overline{W}_{\text{so}}(e)) = (f_1, f_2) \in \mathbb{Q}[c] \times \mathbb{Q}[c]$$

be a linear combination with $\lambda(e) \in \mathbb{Q}$. We want to show that $f = 0$ implies that all scalars $\lambda(e)$ are 0. For our arguments we will use the entries of Table 2 beginning at its bottom. The coefficients $\lambda(D_{n-i,i,0}^\ell)$ (resp. $\lambda(D_{i,\ell-1-i,n-\ell+1}^\ell)$) and $\lambda(D_{0,0,n}^\ell)$ are 0 because they are multiples of

$$\frac{d^k f_2}{dc^k}(0), \dots, \frac{d^{\ell-1} f_2}{dc^{\ell-1}}(0)$$

with $k = \max\{1, \ell - n + 1\}$. The coefficients $\lambda(D_{i,0,0}^\ell \# \omega_{n-i})$ must be 0 by a similar argument for f_1 . We get $\lambda(E_n^\ell) = 0$ because $\overline{W}_{\text{so}}(D_i)(2) = 0$ and $\overline{W}_{\text{so}}(E_n^\ell)(2) \neq 0$. The remaining coefficients $\lambda(D_i)$ are 0 because the values $(\overline{W}_{\text{gt}}(D_i), \overline{W}_{\text{so}}(D_i))$ are linearly independent. This implies $\dim(\mathcal{H}'_{n,\ell} + \mathcal{F}'_{n,\ell}) \geq \text{card}(\mathcal{M}_{n,\ell})$. By Lemma 8 and Lemma 13 we have

$$\begin{aligned} \text{card}(\mathcal{M}_{n,\ell}) + 2 &\leq \dim(\mathcal{H}'_{n,\ell} + \mathcal{F}'_{n,\ell}) + \dim(\mathcal{H}'_{n,\ell} \cap \mathcal{F}'_{n,\ell}) = \\ &= \dim \mathcal{H}'_{n,\ell} + \dim \mathcal{F}'_{n,\ell} \leq \begin{cases} 3n - 1 & \text{if } n < \ell, \\ n + \ell - 1 + [(n + \ell - 1)/2] & \text{if } n \geq \ell. \end{cases} \end{aligned} \tag{29}$$

Comparing with Equation (28) shows that equality must hold in Equation (29). This completes the proof of Parts (2) and (3) of the theorem for all $n \geq 4$. In degrees $n = 1, 2, 3$ we used the diagrams shown in Table (3) (possibly together with some additional circles S^1) to determine $\dim \mathcal{F}'_{n,\ell}$.

$n = 1$	L_1
$n = 2$	ω_2, C_2, L_2
$n = 3$	$\omega_3, \Omega_3 := \text{---} \bigcirc \text{---} \bigcirc \text{---}, \omega_2 \# L_1, T_3, C_3$

Table 3: Diagrams used in low degrees

In the calculation we used the explicit formulas for the values of \overline{W}_{so} from the proof of Lemma 9 together with $\overline{W}_{\text{so}}(\Omega_3) = 2c(c - 1)(2 - c)$. The number of linearly independent values coincides in all of these cases with the upper bound for $\dim \mathcal{F}'_{n,\ell}$ from Lemma 8 or with $\dim \overline{\mathcal{A}}_{n,\ell}$. For $\ell \geq 4$ and $a \in \overline{\mathcal{A}}_{3,3}$ we have

$$\text{ord} \left(\overline{W}_{\text{gt}} \left(L_3 \amalg S^{1 \amalg \ell - 4} \right) \right) = \ell - 3 \quad \text{and} \quad \text{ord} \left(\overline{W}_{\text{gt}} \left(a \amalg S^{1 \amalg \ell - 3} \right) \right) \geq \ell - 2.$$

Together with Lemmas 8 and 13 this implies

$$3 + 5 - 2 \geq \dim(\mathcal{H}'_{3,\ell} + \mathcal{F}'_{3,\ell}) \geq \dim \mathcal{F}'_{3,3} + 1 = 6$$

and therefore $\dim(\mathcal{H}'_{3,\ell} + \mathcal{F}'_{3,\ell}) = 6$ and $\dim(\mathcal{H}'_{3,\ell} \cap \mathcal{F}'_{3,\ell}) = 2$ for $\ell \geq 4$. In the cases $n = 1, 2$, and in the case $n = 3$ and $\ell < 4$, we have $\dim \mathcal{H}'_{n,\ell} \leq 2$ and obtain $\dim(\mathcal{H}'_{n,\ell} \cap \mathcal{F}'_{n,\ell}) = \dim \mathcal{H}'_{n,\ell}$ by applying Lemma 13. This completes the proof. \square

Corollary 2 can now be proven easily.

Proof of Corollary 2. Proposition 5, Lemma 13, and Part (3) of Theorem 1 imply

$$\begin{aligned} \dim(\text{span}\{r_n^\ell, y_n^\ell\}) &= \dim(\text{span}\{W(r_n^\ell), W(y_n^\ell)\}) \\ &= \min(\dim \mathcal{H}'_{n,\ell}, 2) = \min(\dim \mathcal{H}_{n,\ell}, 2) = \dim(\mathcal{H}_{n,\ell} \cap \mathcal{F}_{n,\ell}). \end{aligned}$$

By Proposition 4 we have $r_n^\ell, y_n^\ell \in \mathcal{H}_{n,\ell} \cap \mathcal{F}_{n,\ell}$. This implies the statement $\text{span}\{r_n^\ell, y_n^\ell\} = \mathcal{H}_{n,\ell} \cap \mathcal{F}_{n,\ell}$ of the corollary. \square

Using Theorem 1 and Proposition 12 we can also prove Theorem 3.

Proof of Theorem 3. By Proposition 12 we have

$$\dim(\mathcal{H}'_n + \mathcal{F}'_n)|_{\mathcal{P}_n} = b_n := \begin{cases} [n/2] & n \leq 3 \\ n + [n/2] - 4 & n \geq 4. \end{cases}$$

This implies that in the graded algebra A generated by $\bigoplus_{n=0}^\infty (\mathcal{H}'_n + \mathcal{F}'_n)$ we find a subalgebra $B \subseteq A$ which is a polynomial algebra with b_n generators in degree n . For $n \geq 4$ we find by Equation (21) a nontrivial element $w \in \mathcal{F}'_n$ lying in the algebra generated by $\bigoplus_{n=1}^{n-1} \mathcal{F}'_n$. This shows that A is generated by a_n elements in degree n with $a_n := \dim(\mathcal{H}'_n + \mathcal{F}'_n) - 1$ for $n \geq 4$ and $a_n := \dim(\mathcal{H}'_n + \mathcal{F}'_n)$ for $n \leq 3$. By Theorem 1 we have $a_n = b_n$. Now $B \subseteq A$ implies $A = B$. By Proposition 5 the isomorphism Z^* maps A to the algebra generated by $\bigoplus_{n=0}^\infty (\mathcal{H}_n + \mathcal{F}_n)$. This completes the proof. \square

REFERENCES

[BN1] D. Bar-Natan, *On the Vassiliev knot invariants*, Topology 34 (1995), 423–472.
 [BNG] D. Bar-Natan and S. Garoufalidis, *On the Melvin-Morton-Rozansky conjecture*, Invent. Math. 125 (1996), 103–133.
 [Bra] R. Brauer, *On algebras which are connected with the semisimple continuous groups*, Annals of Math. 38 (1937), 857–872.
 [CoG] R. Correale, E. Guadagnini, *Large- N Chern-Simons field theory*, Phys. Letters B 337 (1994), 80–85.

- [Jon] V. F. R. Jones, *A polynomial invariant for knots via von Neumann algebras*, Bull. of AMS 12 (1985), 103–111.
- [HOM] P. Freyd, J. Hoste, W. B. R. Lickorish, K. Millet, A. Ocneanu and D. Yetter, *A new polynomial invariant of knots and links*, Bull. of AMS 12 (1985), 239–246.
- [KMT] T. Kanenobu, Y. Miyazawa and A. Tani, *Vassiliev link invariants of order three*, J. of Knot Theory and its Ramif. 7, No. 4 (1998), 433–462.
- [Kas] C. Kassel, *Quantum groups*, GTM 155, Springer-Verlag, New York 1995.
- [KaT] C. Kassel and V. Turaev, *Chord diagram invariants of tangles and graphs*, Duke Math. J. 92 (1998), 497–552.
- [Ka1] L. H. Kauffman, *State models and the Jones polynomial*, Topology 26 (1987), 395–407.
- [Ka2] L. H. Kauffman, *An invariant of regular isotopy*, Trans. Am. Math. Soc. 318, No. 2 (1990), 417–471.
- [Ka3] L. H. Kauffman, *Knots and Physics (second edition)*, World Scientific, Singapore 1993.
- [Kn1] J. A. Kneissler, *Woven braids and their closures*, J. of Knot Theory and its Ramif. 8, No. 2 (1999), 201–214.
- [Kn2] J. A. Kneissler, *The number of primitive Vassiliev invariants up to degree twelve*, q-alg/9706022 and University of Bonn preprint, June 1997.
- [Lam] H. Lamaugarny, *Spécialisations communes entre le polynôme de Kauffman et le polynôme de Jones–Conway*, C. R. Acad. Sci. Paris, t. 313, Série I (1991), 289–292.
- [LM1] T. Q. T. Le and J. Murakami, *Kontsevich’s integral for the Homfly polynomial and relations between values of multiple zeta functions*, Topology and its Appl. 62 (1995), 193–206.
- [LM2] T. Q. T. Le and J. Murakami, *Kontsevich integral for the Kauffman polynomial*, Nagoya Math. J., 142 (1996), 39–65.
- [LM3] T. Q. T. Le and J. Murakami, *The universal Vassiliev–Kontsevich invariant for framed oriented links*, Comp. Math. 102 (1996), 41–64.
- [Lie] J. Lieberum, *Chromatic weight systems and the corresponding knot invariants*, Math. Ann., to appear.
- [Lik] W. B. R. Lickorish, *Polynomials for links*, London Math. Soc. Bulletin 20 (1988), 558–588.
- [Men] G. Meng, *Bracket models for weight systems and the universal Vassiliev invariants*, Topology and its Appl. 76 (1997), 47–60.

- [Sul] P. Sulpice, *Invariants de nœuds et filtration de Vassiliev*, Thèse de Doctorat de l'Université Paris VII, 1997.
- [Vog] P. Vogel, *Algebraic structures on modules of diagrams*, Invent. Math., to appear.

Jens Lieberum
MSRI
1000 Centennial Drive
Berkeley, CA 94720-5070
USA
lieberum@msri.org

ON THE INNER DANIELL-STONE
AND RIESZ REPRESENTATION THEOREMS

HEINZ KÖNIG

Received: October 19, 1999

Revised: May 25, 2000

Communicated by Alfred K. Louis

ABSTRACT. The paper deals with the context of the inner Daniell-Stone and Riesz representation theorems, which arose within the new development in measure and integration in the book 1997 and subsequent work of the author. The theorems extend the traditional ones, in case of the Riesz theorem to arbitrary Hausdorff topological spaces. The extension enforces that the assertions attain different forms. The present paper wants to exhibit special situations in which the theorems retain their familiar appearance.

1991 Mathematics Subject Classification: 28A12, 28A25, 28C05, 28C15

Keywords and Phrases: Inner extensions, inner premeasures, Radon measures, Radon premeasures, positive (=isotone) linear functionals, inner sources, inner preintegrals, Radon preintegrals, tightness, theorem of Kiszyński

In the recent book [3] on measure and integration (cited as MI) and in subsequent papers [4]-[10] the present author attempted to restructure the area of the basic extension and representation procedures and results, and to develop the implications on various issues in measure and integration and beyond. One main point was to extend the Riesz representation theorem in terms of Radon measures on locally compact Hausdorff topological spaces, one of the most famous and important theorems in abstract analysis, to arbitrary Hausdorff topological spaces. The resultant theorem in MI section 16 was a direct specialization of the new inner type Daniell-Stone representation theorem in terms of abstract measures in MI section 15. This is in quite some contrast to the traditional situation, where the Daniell-Stone theorem does not furnish the Riesz theorem.

However, the two new theorems look different from their traditional versions, because of the inherent so-called *tightness* conditions. The conditions of this

type came up in the characterization of Radon premeasures due to Kisyński [2], and dominated the subsequent extension and representation theories ever since. They are an unavoidable consequence of the transition from rings of subsets to lattices, and from lattice subspaces of functions to lattice cones, a transition which forms the basis of the theories in question. It is of course desirable to exhibit comprehensive special situations in which the relevant tightness conditions become automatic facts, as it has been done in the second part of MI section 7 in the extension theories for set functions.

The present paper wants to obtain some such situations. Section 1 recalls the context. Then section 2 considers the Daniell-Stone theorem, while section 3 specializes to the Riesz theorem. At last the short section 4 uses the occasion to comment on related recent work of Zakharov and Mikhalev [13]-[16].

1. INNER PREINTEGRALS

We adopt the terms of MI but shall recall the less familiar ones. The extension and representation theories in MI come in three parallel versions. They are marked $\bullet = \star\sigma\tau$, where \star is to be read as *finite*, σ as *sequential* or countable, and τ as *nonsequential* or arbitrary (or as the respective adverbs).

Let X be a nonvoid set. For a nonvoid set system \mathfrak{S} in X we define \mathfrak{S}^\bullet and \mathfrak{S}_\bullet to consist of the unions and intersections of its nonvoid \bullet subsystems. If $\emptyset \in \mathfrak{S}$ then for an isotone set function $\varphi : \mathfrak{S} \rightarrow [0, \infty]$ with $\varphi(\emptyset) = 0$ we define the *outer* and *inner \bullet envelopes* $\varphi^\bullet, \varphi_\bullet : \mathfrak{P}(X) \rightarrow [0, \infty]$ to be

$$\begin{aligned}\varphi^\bullet(A) &= \inf\{\sup_{S \in \mathfrak{M}} \varphi(S) : \mathfrak{M} \subset \mathfrak{S} \text{ nonvoid } \bullet \text{ with } \mathfrak{M} \uparrow \supset A\}, \\ \varphi_\bullet(A) &= \sup\{\inf_{S \in \mathfrak{M}} \varphi(S) : \mathfrak{M} \subset \mathfrak{S} \text{ nonvoid } \bullet \text{ with } \mathfrak{M} \downarrow \subset A\},\end{aligned}$$

in the obvious terms of MI and with the usual convention $\inf \emptyset := \infty$. For a nonvoid function class $E \subset [0, \infty]^X$ on X we define E^\bullet and E_\bullet to consist of the pointwise suprema and infima of its nonvoid \bullet subclasses. If $0 \in E$ then for an isotone functional $I : E \rightarrow [0, \infty]$ with $I(0) = 0$ we define the *outer* and *inner \bullet envelopes* $I^\bullet, I_\bullet : [0, \infty]^X \rightarrow [0, \infty]$ to be

$$\begin{aligned}I^\bullet(f) &= \inf\{\sup_{u \in M} I(u) : M \subset E \text{ nonvoid } \bullet \text{ with } M \uparrow \geq f\}, \\ I_\bullet(f) &= \sup\{\inf_{u \in M} I(u) : M \subset E \text{ nonvoid } \bullet \text{ with } M \downarrow \leq f\}.\end{aligned}$$

In the sequel we restrict ourselves to the *inner* theories, but note that in MI and in [7]-[9] the outer ones are presented as well. Also it is explained that in some more abstract frame at least the outer and inner extension theories for set functions are identical. For concrete purposes the inner approach turns out to be the more important one. But this approach requires that one starts with *finite* set functions $\varphi : \mathfrak{S} \rightarrow [0, \infty[$, and likewise with $E \subset [0, \infty[^X$ and $I : E \rightarrow [0, \infty[$.

Let \mathfrak{S} be a lattice in X with $\emptyset \in \mathfrak{S}$ and $\varphi : \mathfrak{S} \rightarrow [0, \infty[$ be isotone with $\varphi(\emptyset) = 0$. We define an *inner \bullet extension* of φ to be an extension $\alpha : \mathfrak{A} \rightarrow [0, \infty]$

of φ which is a content on a ring, such that also $\mathfrak{S}_\bullet \subset \mathfrak{A}$ and

- α is inner regular \mathfrak{S}_\bullet , and
- $\alpha|_{\mathfrak{S}_\bullet}$ is downward \bullet continuous (which is void for $\bullet = \star$).

Then we define φ to be an *inner \bullet premeasure* iff it admits inner \bullet extensions. The *inner \bullet main theorem* MI 6.31 characterizes those φ which are inner \bullet premeasures, and then describes all inner \bullet extensions of φ . The theorem is in terms of the *inner \bullet envelopes* φ_\bullet of φ defined above and of their so-called satellites, and with *inner \bullet tightness* as the essential condition. We shall not repeat the main theorem, as it has been done in [7] section 1 and [8] section 1, but instead quote an implication which will be referred to in the sequel.

RECOLLECTION 1.1 (for $\bullet = \sigma\tau$). *Let \mathfrak{S} be a lattice and \mathfrak{A} be a σ algebra in X with $\emptyset \in \mathfrak{S} \subset \mathfrak{S}_\bullet \subset \mathfrak{A} \subset \text{A}\sigma(\mathfrak{S} \top \mathfrak{S}_\bullet)$ (where \top denotes the transporter). Then there is a one-to-one correspondence between the inner \bullet premeasures $\varphi : \mathfrak{S} \rightarrow [0, \infty[$ and the measures $\alpha : \mathfrak{A} \rightarrow [0, \infty]$ such that*

- $\alpha|_{\mathfrak{S}} < \infty$ and hence $\alpha|_{\mathfrak{S}_\bullet} < \infty$,
- α is inner regular \mathfrak{S}_\bullet , and
- $\alpha|_{\mathfrak{S}_\bullet}$ is downward \bullet continuous.

The correspondence is $\alpha = \varphi_\bullet|_{\mathfrak{A}}$ and $\varphi = \alpha|_{\mathfrak{S}}$.

For the next step we recall from MI section 11 the integral of Choquet type called the *horizontal* integral. Let \mathfrak{S} be a lattice in X with $\emptyset \in \mathfrak{S}$. We form the function classes

- LM(\mathfrak{S}) : the $f \in [0, \infty]^X$ such that $[f > t] \in \mathfrak{S}$ for all $t > 0$,
- UM(\mathfrak{S}) : the $f \in [0, \infty]^X$ such that $[f \geq t] \in \mathfrak{S}$ for all $t > 0$.

Let $\varphi : \mathfrak{S} \rightarrow [0, \infty]$ be an isotone set function with $\varphi(\emptyset) = 0$. We define the integral $\int f d\varphi \in [0, \infty]$ with respect to φ

$$\begin{aligned} \text{for } f \in \text{LM}(\mathfrak{S}) \quad \text{to be} \quad \int f d\varphi &= \int_{0 \leftarrow}^{\rightarrow \infty} \varphi([f > t]) dt, \\ \text{for } f \in \text{UM}(\mathfrak{S}) \quad \text{to be} \quad \int f d\varphi &= \int_{0 \leftarrow}^{\rightarrow \infty} \varphi([f \geq t]) dt, \end{aligned}$$

both times as an improper Riemann integral of a monotone function with values in $[0, \infty]$. It is well-defined since for $f \in \text{LM}(\mathfrak{S}) \cap \text{UM}(\mathfrak{S})$ the two last integrals are equal. If \mathfrak{S} is a σ algebra then $\text{LM}(\mathfrak{S}) = \text{UM}(\mathfrak{S})$ consists of the functions $f \in [0, \infty]^X$ which are measurable \mathfrak{S} in the usual sense, and in case of a measure $\varphi : \mathfrak{S} \rightarrow [0, \infty]$ then $\int f d\varphi$ is the usual integral $\int f d\varphi$.

After this we introduce the class of functionals which are to be represented. Let $E \subset [0, \infty]^X$ be a lattice cone in the pointwise operations, which is meant to include $0 \in E$. We recall from [9] that the remainder of the present section can be preserved even when E need not be stable under addition. We form the set systems

$$\begin{aligned} \mathfrak{t}(E) &:= \{A \subset X : \chi_A \in E\}, \\ \mathfrak{\geq}(E) &:= \{[f \geq t] : f \in E \text{ and } t > 0\}, \end{aligned}$$

which are lattices with $\emptyset \in \mathfrak{t}(E) \subset \geq(E)$. E is called *Stonean* iff $f \in E \Rightarrow f \wedge t$, $f - f \wedge t = (f - t)^+ \in E$ for all $t > 0$. We recall from MI 15.2 or [9] 3.2 that for E Stonean

$$\mathfrak{t}(E_\bullet) = \geq(E_\bullet) = (\geq(E))_\bullet \supset \geq(E) \supset \mathfrak{t}(E) \quad \text{for } \bullet = \sigma\tau.$$

Next let $I : E \rightarrow [0, \infty[$ be an isotone and positive-linear functional, which implies that $I(0) = 0$. We define the *inner sources* of I to be the isotone set functions $\varphi : \geq(E) \rightarrow [0, \infty[$ with $\varphi(\emptyset) = 0$ which fulfil $I(f) = \int f d\varphi$ for all $f \in E$.

Then we define I to be an *inner \bullet preintegral* if it admits inner sources which are inner \bullet premeasures. We note an immediate consequence of the above 1.1 which characterizes the inner \bullet preintegrals via representation in terms of certain measures.

RECOLLECTION 1.2 (for $\bullet = \sigma\tau$). *Let $E \subset [0, \infty[^X$ be a lattice cone and \mathfrak{A} be a σ algebra in X with $(\geq(E))_\bullet \subset \mathfrak{A} \subset \text{As}(\geq(E) \top (\geq(E))_\bullet)$. Let $I : E \rightarrow [0, \infty[$ be isotone and positive-linear. Then there is a one-to-one correspondence between the inner sources $\varphi : \geq(E) \rightarrow [0, \infty[$ of I which are inner \bullet premeasures, and the measures $\alpha : \mathfrak{A} \rightarrow [0, \infty[$ which fulfil $I(f) = \int f d\alpha$ for all $f \in E$ and hence $\alpha|_{\geq(E)} < \infty$, and are such that*

$$\begin{aligned} \alpha &\text{ is inner regular } (\geq(E))_\bullet, \text{ and} \\ \alpha|_{(\geq(E))_\bullet} &\text{ is downward } \bullet \text{ continuous.} \end{aligned}$$

The correspondence is $\alpha = \varphi_\bullet|_{\mathfrak{A}}$ and $\varphi = \alpha|_{\geq(E)}$.

We come to the fundamental inner \bullet Daniell-Stone theorem MI 15.9 (for $\bullet = \sigma\tau$), which is an intrinsic characterization of the inner \bullet preintegrals; an extended version is [9] 5.8. The theorem is in terms of the inner \bullet envelopes I_\bullet of I defined above and of their satellites $I_\bullet^v : [0, \infty]^X \rightarrow [0, \infty[$ for $v \in E$, defined to be

$$I_\bullet^v(f) = \sup_{u \in M} \{ \inf_{u \in M} I(u) : M \subset E \text{ nonvoid } \bullet \text{ with } M \downarrow \leq f \text{ and } u \leq v \forall u \in M \}.$$

THEOREM 1.3 (for $\bullet = \sigma\tau$). *Let $E \subset [0, \infty[^X$ be a Stonean lattice cone and $I : E \rightarrow [0, \infty[$ be isotone and positive-linear. Then the following are equivalent.*

- 1) I is an inner \bullet preintegral.
- 2) I is downward \bullet continuous; and

$$I(v) - I(u) \leq I_\bullet(v - u) \quad \text{for all } u \leq v \text{ in } E.$$

- 3) I is \bullet continuous at 0; and

$$I(v) - I(u) \leq I_\bullet^v(v - u) \quad \text{for all } u \leq v \text{ in } E.$$

In this case $\varphi := I^*(\chi_\cdot)|_{\geq(E)}$ is the unique inner source of I which is an inner \bullet premeasure. It fulfils $\varphi_\bullet = I_\bullet(\chi_\cdot)$, and even $I_\bullet(f) = \int f d\varphi_\bullet$ for all $f \in [0, \infty]^X$.

We conclude the section with another characterization of the inner \bullet preintegrals. It is of interest because it relates this class to the simpler class of inner

\star premeasures. The proof does not depend on the above inner \bullet Daniell-Stone theorem, but uses some basic results from [9].

THEOREM 1.4 (for $\bullet = \sigma\tau$). *Let $E \subset [0, \infty]^X$ be a Stonean lattice cone and $I : E \rightarrow [0, \infty[$ be isotone and positive-linear. Then the following are equivalent.*

- 1) I is an inner \bullet preintegral.
- 2) I is \bullet continuous at 0; and $\varphi := I^*(\chi.)|_{\geq(E)}$ is an inner \bullet premeasure.
- 3) I is \bullet continuous at 0; and $\phi := I^*(\chi.)|_{(\geq(E))_\bullet}$ is an inner \star premeasure.

In this case $I_\bullet(\chi.) = \varphi_\bullet = \phi_\star$.

Proof. 1) \Rightarrow 2) follows at once from [9] 4.2. 2) \Rightarrow 1) From [9] 2.3 we see that I is truncable in the sense of that paper. Then [9] 2.12 implies that φ is an inner source of I . Thus I is an inner \bullet preintegral.

1)2) \Rightarrow 3) Let $\alpha : \mathfrak{A} \rightarrow [0, \infty]$ be an inner \bullet extension of φ . i) From MI 6.18 we have $\alpha = \varphi_\bullet|_{\mathfrak{A}}$, and hence from MI 6.5.iii) that $\alpha|_{(\geq(E))_\bullet}$ is downward \bullet continuous. ii) From [9] 4.2 we see that I is downward \bullet continuous, and hence from [9] 3.5.1.Inn)2.Inn) that $I^*|_{E_\bullet}$ is downward \bullet continuous. Because of $(\geq(E))_\bullet = \mathfrak{t}(E_\bullet)$ therefore $\phi = I^*(\chi.)|_{(\geq(E))_\bullet}$ is downward \bullet continuous. iii) On $\geq(E)$ we have $\alpha = \varphi_\bullet = \varphi = I^*(\chi.) = \phi$. Since $\alpha|_{(\geq(E))_\bullet}$ and ϕ are both downward \bullet continuous by i)ii) it follows that $\alpha|_{(\geq(E))_\bullet} = \phi$. Thus α is an inner \star extension of ϕ , and hence ϕ is an inner \star premeasure.

3) \Rightarrow 2) From [9] 3.6.3) we see that ϕ is \bullet continuous at \emptyset , and hence from MI 6.31 that ϕ is an inner \bullet premeasure. Now each inner \bullet extension of ϕ is also an inner \bullet extension of φ . Therefore φ is an inner \bullet premeasure.

It remains to prove $I_\bullet(\chi.) = \varphi_\bullet = \phi_\star$ under 1)2)3). From [9] 4.2 we know that $I_\bullet(\chi.) = \varphi_\bullet$. Then $\varphi_\bullet = \phi_\star$ on $(\geq(E))_\bullet$, because from [9] 3.5.1.Inn) and $(\geq(E))_\bullet = \mathfrak{t}(E_\bullet)$ we have $\varphi_\bullet = I_\bullet(\chi.) = I^*(\chi.) = \phi = \phi_\star$. Since both φ_\bullet and ϕ_\star are inner regular $(\geq(E))_\bullet$ it follows that $\varphi_\bullet = \phi_\star$ partout. \square

2. THE INNER DANIELL-STONE THEOREM

The present results will be for $\bullet = \sigma\tau$ as before. We start with a consequence of 1.3 which consists of two parts. The first part has an immediate proof.

THEOREM 2.1. *Let $E \subset [0, \infty]^X$ be a Stonean lattice cone. 1) Assume that $v - u \in E_\bullet$ for all $u \leq v$ in E . Then an isotone and positive-linear functional $I : E \rightarrow [0, \infty[$ is an inner \bullet preintegral iff it is \bullet continuous at 0.*

2) *Assume that $v - u \in (E_\bullet)^\sigma$ for all $u \leq v$ in E . Then an isotone and positive-linear functional $I : E \rightarrow [0, \infty[$ is an inner \bullet preintegral iff it is \bullet continuous at 0 and upward σ continuous.*

A special case of 1) is the situation that $v - u \in E$ for all $u \leq v$ in E . After MI 14.6-7 it is equivalent to assume that $E = H^+$ for the Stonean lattice subspace $H = E - E \subset \mathbb{R}^X$ (Stonean in the usual sense). So this special case furnishes the traditional Daniell-Stone theorem in the versions $\bullet = \sigma\tau$. However, unlike the present procedure the traditional proofs do not lead to measures $\alpha : \mathfrak{A} \rightarrow [0, \infty]$ with $I(f) = \int f d\alpha$ for all $f \in E$ which have the

fundamental additional *inner* properties recorded in 1.2 above. The reason is that those proofs are based on *outer* procedures. In order to arrive at the present inner type entities one has to mount the so-called *essential* construction on top of them. This is a formidable detour. We have clarified all this in [7] section 5.

Proof of 1). To be shown is that the assumption implies the tightness condition in 1.3.3). Fix $u \leq v$ in E , and let $M \subset E$ be nonvoid \bullet with $M \downarrow v - u$ and $h \leq v$ for all $h \in M$. For $h \in M$ then $h \geq v - u$ and hence $I(h) \geq I(v) - I(u)$. It follows that $I(v) - I(u) \leq \inf\{I(h) : h \in M\} \leq I_\bullet^v(v - u)$. \square

Proof of 2). We show that the assumption combined with I upward σ continuous implies the tightness condition in 1.3.3). Fix $u \leq v$ in E , and then a sequence $(f_l)_l$ in E_\bullet with $f_l \uparrow v - u$. i) For each $l \in \mathbb{N}$ there exists an $M(l) \subset E$ nonvoid \bullet such that $M(l) \downarrow f_l$ and $h \leq v$ for all $h \in M(l)$. We note that then the

$$N(l) := \{h_1 \vee \dots \vee h_l : h_k \in M(k) \text{ for } k = 1, \dots, l\} \subset E \quad \text{for } l \in \mathbb{N}$$

do the same. Thus we can assume that for each $g \in M(l+1)$ there is an $f \in M(l)$ such that $f \leq g$. ii) Now fix $\varepsilon > 0$, and then $u_l \in M(l)$ for $l \in \mathbb{N}$ such that

$$I(u_l) \leq c_l + \frac{\varepsilon}{2^l} \quad \text{with } c_l := \inf\{I(h) : h \in M(l)\}.$$

Then the $v_l := u_1 \vee \dots \vee u_l \in E$ fulfil $v_l \geq u_l \geq f_l$ and hence $v_l \uparrow \geq v - u$. We show via induction that

$$I(v_l) \leq c_l + \varepsilon\left(1 - \frac{1}{2^l}\right) \quad \text{for } l \in \mathbb{N}.$$

The case $l = 1$ is clear. For the induction step $1 \leq l \Rightarrow l + 1$ we note from i) that $v_l \wedge u_{l+1} \geq u_l \wedge u_{l+1}$ is \geq some member of $M(l)$, so that $I(v_l \wedge u_{l+1}) \geq c_l$. Thus from $v_{l+1} + v_l \wedge u_{l+1} = v_l + u_{l+1}$ it follows that

$$\begin{aligned} I(v_{l+1}) &= I(v_l) + I(u_{l+1}) - I(v_l \wedge u_{l+1}) \\ &\leq c_l + \varepsilon\left(1 - \frac{1}{2^l}\right) + c_{l+1} + \frac{\varepsilon}{2^{l+1}} - c_l = c_{l+1} + \varepsilon\left(1 - \frac{1}{2^{l+1}}\right). \end{aligned}$$

iii) From ii) we obtain on the one hand $c_l \leq I_\bullet^v(v - u)$ and hence $\lim_{l \rightarrow \infty} I(v_l) \leq I_\bullet^v(v - u) + \varepsilon$. On the other hand $(u + v_l) \wedge v \uparrow v$ because $v \geq (u + v_l) \wedge v \geq (u + f_l) \wedge v = u + f_l \uparrow v$, and hence

$$I(u) + \lim_{l \rightarrow \infty} I(v_l) \geq \lim_{l \rightarrow \infty} I((u + v_l) \wedge v) = I(v).$$

It follows that $I(v) - I(u) \leq I_\bullet^v(v - u)$. \square

In 2.1.2) the condition that I be upward σ continuous cannot be dispensed with. This will be seen after 3.10 below.

In the sequel we shall exhibit a class of Stonean lattice cones $E \subset [0, \infty]^X$ for which the assumption of 2.1.2) is fulfilled. We need some preparations.

Let \mathfrak{S} be a lattice in X with $\emptyset \in \mathfrak{S}$. We define $S(\mathfrak{S})$ to consist of the positive-linear combinations of the characteristic functions χ_S of the $S \in \mathfrak{S}$. We know

from MI 11.4 that $S(\mathfrak{S})$ consists of the functions $X \rightarrow [0, \infty[$ with finite value set which are in $LM(\mathfrak{S})$, and the same with $UM(\mathfrak{S})$. We define $f \in [0, \infty]^X$ to be *enclosable* \mathfrak{S} iff $f \leq u$ for some $u \in S(\mathfrak{S})$. This means of course that f be $< \infty$ and bounded above, and $= 0$ outside some member of \mathfrak{S} . At last we define $LMo(\mathfrak{S})$ and $UMo(\mathfrak{S})$ to consist of those members of $LM(\mathfrak{S})$ and $UM(\mathfrak{S})$ which are enclosable \mathfrak{S} .

After this we recall the assertion MI 22.1 on monotone approximation: *For each $f \in LM(\mathfrak{S}) \cup UM(\mathfrak{S})$ there exists a sequence $(f_n)_n$ in $S(\mathfrak{S})$ such that $f_n \uparrow f$ pointwise, and in supnorm on $[f \leq c]$ for each $0 < c < \infty$.* We shall need the counterpart for downward monotone approximation.

LEMMA 2.2. *For each $f \in LMo(\mathfrak{S}) \cup UMo(\mathfrak{S})$ there exists a sequence $(f_n)_n$ in $S(\mathfrak{S})$ such that $f_n \downarrow f$ pointwise and in supnorm.*

Proof. Assume that $f \leq c$ with $0 < c < \infty$ and that $f = 0$ outside $S \in \mathfrak{S}$. For the subdivision $\mathfrak{t} : 0 = t(0) < t(1) < \dots < t(r) = c$ we form $\delta(\mathfrak{t}) = \max\{t(l) - t(l-1) : l = 1, \dots, r\}$. We define $u_{\mathfrak{t}} \in S(\mathfrak{S})$ to be

$$u_{\mathfrak{t}} = \sum_{l=1}^r (t(l) - t(l-1))\chi_{[f > t(l)]} \quad \text{when } f \in LMo(\mathfrak{S}),$$

$$u_{\mathfrak{t}} = \sum_{l=1}^r (t(l) - t(l-1))\chi_{[f \geq t(l)]} \quad \text{when } f \in UMo(\mathfrak{S}),$$

and $v_{\mathfrak{t}} \in S(\mathfrak{S})$ to be

$$v_{\mathfrak{t}} = \sum_{l=1}^r (t(l) - t(l-1))\chi_{[f > t(l-1)][*]} \quad \text{when } f \in LMo(\mathfrak{S}),$$

$$v_{\mathfrak{t}} = \sum_{l=1}^r (t(l) - t(l-1))\chi_{[f \geq t(l-1)][*]} \quad \text{when } f \in UMo(\mathfrak{S}),$$

where $[*]$ is to mean that for $l = 1$ one has to take S instead of $[f > 0]$ when $f \in LMo(\mathfrak{S})$ and instead of $[f \geq 0]$ when $f \in UMo(\mathfrak{S})$. From the basic lemma MI 11.6 one verifies that $u_{\mathfrak{t}} \leq f \leq v_{\mathfrak{t}}$ and $v_{\mathfrak{t}} \leq u_{\mathfrak{t}} + \delta(\mathfrak{t})\chi_A$, and moreover that $\mathfrak{t} \mapsto u_{\mathfrak{t}}$ is isotone and $\mathfrak{t} \mapsto v_{\mathfrak{t}}$ is antitone with respect to refinement in \mathfrak{t} . Now take for $n \in \mathbb{N}$ the subdivision $\mathfrak{t} : t(l) = c/2^{n-l}$ for $l = 0, 1, \dots, 2^n$ with $\delta(\mathfrak{t}) = c/2^n$. Then the assertions are all clear. \square

The final preparation will be on the monotone approximation of differences.

LEMMA 2.3. *Let \mathfrak{S} and \mathfrak{K} be lattices in X with $\emptyset \in \mathfrak{S} \subset \mathfrak{K}$ such that $B \setminus A \in \mathfrak{K}^\sigma$ for all $A \subset B$ in \mathfrak{S} . Then for each pair of functions $u \leq v < \infty$ in $UM(\mathfrak{S})$ there exists a sequence $(f_n)_n$ of functions in $S(\mathfrak{K})$ enclosable \mathfrak{S} such that $f_n \uparrow v - u$.*

Proof. The first part of the proof assumes that $u \leq v \leq c$ with $0 < c < \infty$ and that $v = 0$ outside some $S \in \mathfrak{S}$. 1) We fix $\mathfrak{t} : 0 = t(0) < t(1) < \dots < t(r) = c$ with $\delta(\mathfrak{t}) = \max\{t(l) - t(l-1) : l = 1, \dots, r\}$ as before and define $u_{\mathfrak{t}}, v_{\mathfrak{t}} \in S(\mathfrak{S})$ to be

$$u_{\mathfrak{t}} = \sum_{l=1}^r (t(l) - t(l-1))\chi_{[u \geq t(l)]},$$

$$v_{\mathfrak{t}} = \sum_{l=1}^r (t(l) - t(l-1))\chi_{[v \geq t(l)]},$$

so that $u_t \leq v_t$ are = 0 outside S . From MI 11.6 we have $u_t \leq u \leq u_t + \delta(t)\chi_S$ and $v_t \leq v \leq v_t + \delta(t)\chi_S$, and hence

$$\begin{aligned} v - u &\geq v_t - u_t - \delta(t)\chi_S \geq v - u - 2\delta(t)\chi_S, \\ v - u &\geq (v_t - u_t - \delta(t)\chi_S)^+ = (v_t - u_t - \delta(t))^+ \geq v - u - 2\delta(t)\chi_S. \end{aligned}$$

2) For fixed $l = 1, \dots, r$ there is a sequence $(K(l, n))_n$ in \mathfrak{K} such that $K(l, n) \uparrow [v \geq t(l)] \setminus [u \geq t(l)]$. We form the functions

$$h_n := \sum_{l=1}^r (t(l) - t(l-1))\chi_{K(l,n)} \in S(\mathfrak{K}) \quad \text{for } n \in \mathbb{N},$$

so that $h_n = 0$ outside S . Then $h_n \uparrow v_t - u_t$. Therefore the functions $g_n := (f_n - \delta(t))^+ \in S(\mathfrak{K})$ are = 0 outside S as well, and $g_n \uparrow (v_t - u_t - \delta(t))^+ =: g$ with $v - u \geq g \geq v - u - 2\delta(t)\chi_S$. 3) From 1)2) we obtain for each $l \in \mathbb{N}$ a sequence $(g_n^l)_n$ in $S(\mathfrak{K})$ with $g_n^l = 0$ outside S such that $g_n^l \uparrow$ some g^l with $v - u \geq g^l \geq v - u - \frac{1}{l}\chi_S$. We define $f_n := g_n^1 \vee \dots \vee g_n^n \in S(\mathfrak{K})$ for $n \in \mathbb{N}$, so that $f_n = 0$ outside S . Then $f_n \uparrow$ some $f \leq v - u$. From $f_n \geq g_n^l$ for $n \geq l$ we obtain $f \geq g^l \geq v - u - \frac{1}{l}\chi_S$ for $l \in \mathbb{N}$. Therefore $f = v - u$. 4) Thus the result of the first part is a sequence $(f_n)_n$ in $S(\mathfrak{K})$ with $f_n = 0$ outside S such that $f_n \uparrow v - u$.

The second part of the proof will obtain the full assertion. Thus let $u \leq v < \infty$ in $UM(\mathfrak{G})$. We fix a pair of numerical sequences $0 < a_l < b_l < \infty$ with $a_l \downarrow 0$ and $b_l \uparrow \infty$. We form

$$u_l := (u - a_l)^+ \wedge (b_l - a_l) \quad \text{and} \quad v_l := (v - a_l)^+ \wedge (b_l - a_l),$$

so that $u_l, v_l \in UM(\mathfrak{G})$ with $u_l \leq v_l \leq b_l - a_l$ which are = 0 outside $[v \geq a_l]$. 1) We claim that $v_l - u_l \leq v_{l+1} - u_{l+1}$, which can also be written $u_{l+1} - u_l \leq v_{l+1} - v_l$. Thus the claim is that the function $\vartheta : [0, \infty[\rightarrow \mathbb{R}$, defined to be

$$\vartheta(x) = (x - a_{l+1})^+ \wedge (b_{l+1} - a_{l+1}) - (x - a_l)^+ \wedge (b_l - a_l) \quad \text{for } 0 \leq x < \infty,$$

is monotone increasing. To see this note that $0 < a_{l+1} \leq a_l < b_l \leq b_{l+1} < \infty$. Since ϑ is continuous it remains to show that it is monotone increasing in each of the closed subintervals of $[0, \infty[$ thus produced. Now one verifies that

$$\begin{aligned} \text{on } [0, a_{l+1}] &: \vartheta(x) = 0, \\ \text{on } [a_{l+1}, a_l] &: \vartheta(x) = x - a_{l+1}, \\ \text{on } [a_l, b_l] &: \vartheta(x) = a_l - a_{l+1}, \\ \text{on } [b_l, b_{l+1}] &: \vartheta(x) = x - a_{l+1} - b_l + a_l, \\ \text{on } [b_{l+1}, \infty[&: \vartheta(x) = b_{l+1} - a_{l+1} - b_l + a_l. \end{aligned}$$

Thus the assertion follows. 2) From the first part of the proof we obtain for each fixed $l \in \mathbb{N}$ a sequence $(f_n^l)_n$ in $S(\mathfrak{K})$ with $f_n^l = 0$ outside $[v \geq a_l]$ such that $f_n^l \uparrow v_l - u_l$. We define $f_n := f_n^1 \vee \dots \vee f_n^n \in S(\mathfrak{K})$ for $n \in \mathbb{N}$, so that $f_n = 0$ outside $[v \geq a_n]$. Then $f_n \uparrow$ some $f \in [0, \infty]^X$. We claim that $f = v - u$, which will complete the proof. From 1) we see that $v_l - u_l \uparrow v - u$. Thus on the one hand $f_n \leq (v_1 - u_1) \vee \dots \vee (v_n - u_n) = v_n - u_n$ and hence $f \leq v - u$. On the

other hand $f_n \geq f_n^l$ for $n \geq l$ and hence $f \geq v_l - u_l$ for $l \in \mathbb{N}$, so that $f \geq v - u$. The assertion follows. \square

COMBINATION 2.4. *Let $E \subset [0, \infty[^X$ be a Stonean lattice cone and \mathfrak{S} be a lattice in X with $\geq(E) \subset \mathfrak{S} \subset \geq(E_\bullet)$. Then 1) $\mathfrak{S}_\bullet = \geq(E_\bullet)$ and $\text{UMo}(\mathfrak{S}_\bullet) \subset E_\bullet \subset \text{UM}(\mathfrak{S}_\bullet)$. 2) Assume that $B \setminus A \in (\mathfrak{S}_\bullet)^\sigma$ for all $A \subset B$ in \mathfrak{S} . Then $v - u \in (E_\bullet)^\sigma$ for all $u \leq v$ in E .*

Proof. 1) We know that $\mathfrak{t}(E_\bullet) = \geq(E_\bullet) = (\geq(E))_\bullet$. Therefore $\mathfrak{S}_\bullet \subset \geq(E_\bullet) = \mathfrak{t}(E_\bullet)$, that is $\chi_T \in E_\bullet$ for all $T \in \mathfrak{S}_\bullet$. Since E_\bullet is a cone it follows that $\text{S}(\mathfrak{S}_\bullet) \subset E_\bullet$. Thus 2.2 implies that $\text{UMo}(\mathfrak{S}_\bullet) \subset E_\bullet$. In the other direction $\geq(E) \subset \mathfrak{S}$ implies that $\geq(E_\bullet) = (\geq(E))_\bullet \subset \mathfrak{S}_\bullet$ or $E_\bullet \subset \text{UM}(\mathfrak{S}_\bullet)$. 2) For $u \leq v$ in $E \subset \text{UM}(\mathfrak{S})$ we obtain from 2.3 a sequence $(f_n)_n$ in $\text{S}(\mathfrak{S}_\bullet) \subset E_\bullet$ such that $f_n \uparrow v - u$. Thus $v - u \in (E_\bullet)^\sigma$. \square

We combine 2.4.2) with the above 2.1.2) to obtain the other main result of the present section.

THEOREM 2.5. *Let $E \subset [0, \infty[^X$ be a Stonean lattice cone and \mathfrak{S} be a lattice in X with $\geq(E) \subset \mathfrak{S} \subset \geq(E_\bullet)$. Assume that \mathfrak{S} satisfies $B \setminus A \in (\mathfrak{S}_\bullet)^\sigma$ for all $A \subset B$ in \mathfrak{S} . Then an isotone and positive-linear functional $I : E \rightarrow [0, \infty[$ is an inner \bullet preintegral iff it is \bullet continuous at 0 and upward σ continuous.*

3. THE RIESZ REPRESENTATION THEOREM

The present section assumes a Hausdorff topological space X with its obvious set systems $\text{Op}(X)$ and $\text{Cl}(X)$, $\text{Comp}(X) =: \mathfrak{K}$ and its σ algebra $\text{Bor}(X) =: \mathfrak{B}$. We start with a little historical sketch on Radon measures.

A Borel measure $\alpha : \mathfrak{B} \rightarrow [0, \infty]$ is called *Radon* iff $\alpha|_{\mathfrak{K}} < \infty$ and α is inner regular \mathfrak{K} . When in particular X is locally compact then all these measures are *locally finite* in the obvious sense. There is a related notion, which in earlier presentations sometimes even cut out the present one. Let a Borel measure $\beta : \mathfrak{B} \rightarrow [0, \infty]$ be called *associate Radon* iff $\beta|_{\mathfrak{K}} < \infty$ and β is inner regular \mathfrak{K} at $\text{Op}(X)$ and outer regular $\text{Op}(X)$. Then Schwartz [12] pp.12-15 established a one-to-one correspondence between the locally finite Radon measures $\alpha : \mathfrak{B} \rightarrow [0, \infty]$ and the associate Radon measures $\beta : \mathfrak{B} \rightarrow [0, \infty]$, which is unique both under $\alpha|_{\mathfrak{K}} = \beta|_{\mathfrak{K}}$ and under $\alpha|_{\text{Op}(X)} = \beta|_{\text{Op}(X)}$. Thus he was led to include local finiteness in the definition of Radon measures, but this could be abandoned since.

After this a set function $\phi : \mathfrak{K} \rightarrow [0, \infty[$ is called a *Radon premeasure* iff it can be extended to some Radon measure, and then of course to the unique one $\alpha := \phi_*|_{\mathfrak{B}}$. It is an obvious problem to characterize those set functions $\phi : \mathfrak{K} \rightarrow [0, \infty[$ which are Radon premeasures. There appeared two such characterizations at about the same time, in 1968 in Kisyński [2] and in 1969 in Bourbaki [1] section 3 théorème 1 p.43 (the latter restricted to local finiteness).

KISYŃSKI THEOREM 3.1. *For an isotone set function $\phi : \mathfrak{K} \rightarrow [0, \infty[$ the following are equivalent. 1) ϕ is a Radon premeasure. 2) ϕ is supermodular*

with $\phi(\emptyset) = 0$; and

$$\phi(B) - \phi(A) \leq \phi_*(B \setminus A) \quad \text{for all } A \subset B \text{ in } \mathfrak{K}.$$

BOURBAKI THEOREM 3.2. *For an isotone set function $\phi : \mathfrak{K} \rightarrow [0, \infty[$ the following are equivalent. 1) ϕ is a Radon premeasure. 2) $\phi(A \cup B) \leq \phi(A) + \phi(B)$ for all $A, B \in \mathfrak{K}$, with $=$ when $A \cap B = \emptyset$; and ϕ is downward τ continuous.*

These two characterizations are so different that they must come from different conceptions. In fact, it turned out that Kisyński had captured the adequate concept in order to prepare the transition from topological to abstract measure and integration, which then started in no time as described in the introduction to MI. At present the above 3.1 is contained in MI 9.1, which is a simple consequence of the inner \bullet main theorem MI 6.31. Moreover MI 9.1 asserts for each $\bullet = \star\sigma\tau$ that $\phi : \mathfrak{K} \rightarrow [0, \infty[$ is a Radon premeasure iff it is an inner \bullet premeasure, and that in this case all three ϕ_\bullet are equal. The reason for this coincidence are the two properties of the lattice \mathfrak{K} that $\mathfrak{K} = \mathfrak{K}_\tau$ and that \mathfrak{K} is τ compact (recall that a set system in an abstract set is called \bullet compact iff each of its nonvoid \bullet subsystems \mathfrak{M} with $\mathfrak{M} \downarrow \emptyset$ has $\emptyset \in \mathfrak{M}$).

Then in 3.2 the implication 1) \Rightarrow 2) is contained in the inherent fact that the inner τ premeasures are downward τ continuous. However, the implication 2) \Rightarrow 1) and thus the characterization asserted in 3.2 appears to be limited to the topological context in the strict sense. The remark below wants to serve as an illustration.

REMARK 3.3. *Let \mathfrak{S} be a lattice in an abstract set with $\emptyset \in \mathfrak{S}$ which fulfils $\mathfrak{S} = \mathfrak{S}_\tau$ and is τ compact. Let $\phi : \mathfrak{S} \rightarrow [0, \infty[$ be isotone and modular with $\phi(\emptyset) = 0$, and downward τ continuous. Then ϕ need not be an inner \bullet premeasure for any $\bullet = \star\sigma\tau$. Our example is the simplest possible one: Let X have more than one element, and fix an $a \in X$. Define \mathfrak{S} to consist of \emptyset and of the finite $S \subset X$ with $a \in S$. Then let $\phi : \mathfrak{S} \rightarrow [0, \infty[$ be $\phi(\emptyset) = 0$ and $\phi(S) = \#(A \setminus \{a\})$ for the other $S \in \mathfrak{S}$. It is obvious that \mathfrak{S} and ϕ are as required. Moreover $\phi_*(A) = 0$ when $a \notin A$ and $\phi_*(A) = \#(A \setminus \{a\})$ when $a \in A$. Now assume that $\alpha : \mathfrak{A} \rightarrow [0, \infty[$ is an extension of ϕ which is a content on a ring and inner regular \mathfrak{S} . Thus $\alpha = \phi_\star|_{\mathfrak{A}}$. For all $A \in \mathfrak{S}$ with $a \in A$ then*

$$\phi(A) = \alpha(A) = \alpha(\{a\}) + \alpha(A \setminus \{a\}) = \phi_\star(\{a\}) + \phi_\star(A \setminus \{a\}) = 0,$$

which is a contradiction. \square

After this excursion we turn to the Riesz representation theorem as obtained in MI section 16, not without notice that the extension of the inner \bullet Daniell-Stone theorem in [9] 5.8 produces of course an extended Riesz theorem. But for the present issue this would not contribute much.

Let $E \subset [0, \infty]^X$ be a lattice cone. Since we want to represent our functionals on E in terms of Radon measures, it is adequate after 1.2 to assume that E satisfies $(\geq(E))_\bullet = \mathfrak{K}$ for some $\bullet = \sigma\tau$. In particular then $\geq(E) \subset \mathfrak{K}$, so that the members of E are upper semicontinuous and bounded above. Since the

traditional Riesz theorem is for the lattice subspace $CK(X)$ of the continuous functions $X \rightarrow \mathbb{R}$ which vanish outside certain compact subsets of X , that is for the lattice cone $CK^+(X)$, it is adequate to assume that $E \subseteq CK^+(X)$, defined to consist of the upper semicontinuous functions $X \rightarrow [0, \infty[$ which vanish outside certain compact subsets of X . In the previous notation we have $USCK^+(X) = UMo(\mathfrak{K})$. Henceforth the lattice cones $E \subseteq USCK^+(X)$ with $(\geq(E))_\bullet = \mathfrak{K}$ will be called \bullet rich; it will become clear that the situation $\bullet = \tau$ is the more important one. From 2.4.1) one obtains the remark below.

REMARK 3.4. *If $E \subseteq USCK^+(X)$ is a \bullet rich Stonean lattice cone then $E_\bullet = USCK^+(X)$.*

EXAMPLES 3.5. 1) The lattice cone $E = CK^+(X)$ is τ rich iff X is locally compact. This is a standard fact; see for example MI 16.3. 2) If the lattice cone $E \subseteq USCK^+(X)$ satisfies $\mathfrak{S} \subseteq \geq(E_\bullet)$ for some lattice \mathfrak{S} in X with $\emptyset \in \mathfrak{S} \subseteq \mathfrak{S}_\bullet = \mathfrak{K}$ then E is \bullet rich. In fact, we have $\mathfrak{S} \subseteq \geq(E_\bullet) = (\geq(E))_\bullet \subseteq \mathfrak{K}$.

In the sequel let $E \subseteq USCK^+(X)$ be a \bullet rich lattice cone. We define an isotone and positive-linear functional $I : E \rightarrow [0, \infty[$ to be a *Radon preintegral* iff there exists a Radon measure $\alpha : \mathfrak{B} \rightarrow [0, \infty]$ such that $I(f) = \int f d\alpha$ for all $f \in E$. Equivalent is of course that there exists a Radon premeasure $\phi : \mathfrak{K} \rightarrow [0, \infty[$ such that $I(f) = \int f d\phi$ for all $f \in E$, and these α and ϕ correspond to each other via $\alpha = \phi_\star | \mathfrak{B}$ and $\phi = \alpha | \mathfrak{K}$.

We turn to the connection with the previous representation theories. We start with 1.2, where \mathfrak{A} can be chosen to be \mathfrak{B} .

PROPOSITION 3.6 (for $\bullet = \sigma\tau$). *Let $E \subseteq USCK^+(X)$ be a \bullet rich lattice cone and $I : E \rightarrow [0, \infty[$ be isotone and positive-linear. Then I is a Radon preintegral iff it is an inner \bullet preintegral. In this case the inner sources $\varphi : \geq(E) \rightarrow [0, \infty[$ of I which are inner \bullet premeasures correspond to the above α and ϕ via $\varphi = \alpha | \geq(E) = \phi | \geq(E)$, and $\alpha = \varphi_\bullet | \mathfrak{B}$ and $\phi = \varphi^\star | \mathfrak{K} = \varphi_\bullet | \mathfrak{K}$.*

If in particular E is Stonean then first of all the Dini consequence MI 16.4 asserts that all these $I : E \rightarrow [0, \infty[$ are τ continuous at 0. Thus 1.3 and 1.4 furnish the Riesz representation theorem in the version which follows.

THEOREM 3.7 (for $\bullet = \sigma\tau$). *Let $E \subseteq USCK^+(X)$ be a \bullet rich Stonean lattice cone and $I : E \rightarrow [0, \infty[$ be isotone and positive-linear. Then the following are equivalent. 1) I is a Radon preintegral.*

- 2) I is an inner \bullet preintegral.
- 3) $I(v) - I(u) \leq I_\bullet^v(v - u)$ for all $u \leq v$ in E .
- 4) $\varphi := I^\star(\chi_\cdot) | \geq(E)$ is an inner \bullet premeasure.
- 5) $\phi := I^\star(\chi_\cdot) | \mathfrak{K}$ is a Radon premeasure.

In this case φ is the unique inner source of I which is an inner \bullet premeasure, and ϕ is the unique Radon premeasure which represents I ; likewise $\alpha := I_\bullet(\chi_\cdot) | \mathfrak{B}$ is the unique Radon measure which represents I . We have $I_\bullet(\chi_\cdot) = \varphi_\bullet = \phi_\star = \alpha_\star$.

Our ultimate aim is the specialization of 2.1 and 2.5. We have $\bullet = \sigma\tau$ as before, but this time the case $\bullet = \sigma$ is contained in $\bullet = \tau$.

THEOREM 3.8. *Let $E \subset \text{USCK}^+(X)$ be a τ rich Stonean lattice cone. 1) Assume that $v - u \in \text{USCK}^+(X)$ for all $u \leq v$ in E . Then each isotone and positive-linear $I : E \rightarrow [0, \infty[$ is a Radon preintegral.*

2) *Assume that $v - u \in (\text{USCK}^+(X))^\sigma$ for all $u \leq v$ in E . Then an isotone and positive-linear $I : E \rightarrow [0, \infty[$ is a Radon preintegral iff it is upward σ continuous.*

In view of 3.5.1) the first assertion 3.8.1) contains the traditional Riesz representation theorem. Thus we have the traditional Daniell-Stone and Riesz theorems both under the same roof (and at the same time, as pointed out after 2.1, the former one enriched to a usable assertion).

THEOREM 3.9. *Let \mathfrak{S} be a lattice in X with $\emptyset \in \mathfrak{S} \subset \mathfrak{S}_\tau = \mathfrak{K}$ and $E \subset \text{UMo}(\mathfrak{S}) \subset \text{USCK}^+(X)$ be a τ rich Stonean lattice cone. Assume that $B \setminus A \in \mathfrak{K}^\sigma$ for all $A \subset B$ in \mathfrak{S} . Then an isotone and positive-linear functional $I : E \rightarrow [0, \infty[$ is a Radon preintegral iff it is upward σ continuous.*

Proof. We have in fact $\geq(E) \subset \mathfrak{S} \subset \geq(E_\tau)$. Thus the assertion follows from 2.5, and likewise from 3.8.2) and hence from 2.1.2) via 2.4.2). \square

We conclude with two illustrative examples, in that we specialize 3.9 to $\mathfrak{S} := \mathfrak{K}$ and to $\mathfrak{S} := \mathfrak{K} \cap (\text{Op}(X))_\sigma$ (=the compact G_δ subsets).

EXAMPLE 3.10. Assume that $B \setminus A \in \mathfrak{K}^\sigma$ for all $A \subset B$ in \mathfrak{K} , that is that \mathfrak{K} is upward σ full in the sense of MI section 7. Let $E \subset \text{USCK}^+(X)$ be a τ rich Stonean lattice cone; in particular one can take $E = \text{USCK}^+(X)$ itself. Then an isotone and positive-linear $I : E \rightarrow [0, \infty[$ is a Radon preintegral iff it is upward σ continuous.

We turn to the counterexample announced after 2.1. As before assume that $B \setminus A \in \mathfrak{K}^\sigma$ for all $A \subset B$ in \mathfrak{K} . Consider an isotone and modular set function $\phi : \mathfrak{K} \rightarrow [0, \infty[$ with $\phi(\emptyset) = 0$ which is not a Radon premeasure; there is an example with $X = [0, 1]$ in [10] 1.4. In view of MI 11.11 then $I(f) = \int f d\phi$ for all $f \in E = \text{USCK}^+(X)$ defines an isotone and positive-linear $I : E \rightarrow [0, \infty[$ which is not a Radon preintegral. Thus we see that in 3.9 and 2.5, and likewise in 3.8.2) and 2.1.2), the condition that I be upward σ continuous cannot be dispensed with.

EXAMPLE 3.11. Assume that the lattice $\mathfrak{S} = \mathfrak{K} \cap (\text{Op}(X))_\sigma$ fulfils $\mathfrak{S}_\tau = \mathfrak{K}$. Let $E \subset \text{UMo}(\mathfrak{S}) \subset \text{USCK}^+(X)$ be a τ rich Stonean lattice cone; in particular one can take $E = \text{UMo}(\mathfrak{S})$ itself in view of MI 11.1.3). Then an isotone and positive-linear $I : E \rightarrow [0, \infty[$ is a Radon preintegral iff it is upward σ continuous.

4. COMPARISON WITH ANOTHER APPROACH

The present final section wants to relate the previous one to recent work of Zakharov and Mikhalev [13]-[16]; see also the conference abstracts [11][17]. This

work has the aim to transfer one basic feature within the Riesz representation theorem to arbitrary Hausdorff topological spaces. It does in fact not even contain the Riesz theorem itself, but rather wants, in the words of the authors, to find a class of linear functionals which via integration is in one-to-one correspondence with the class of Radon measures on the space. Nonetheless this less ambitious aim is called the *General Riesz-Radon problem*.

We retain the terms of the last section. The approach of the authors is via the simple lattice cone $S(\mathfrak{K})$, but in terms of a certain lattice *subspace*. For a lattice \mathfrak{G} in X with $\emptyset \in \mathfrak{G}$ define $D(\mathfrak{G}) := S(\mathfrak{G}) - S(\mathfrak{G})$, that is to consist of the real-linear combinations of the χ_S for $S \in \mathfrak{G}$. We form the supnorm closure $H(X) := \overline{D(Cl(X))}$ in the space of all (Borel measurable) bounded functions $X \rightarrow \mathbb{R}$. The members of $H(X)$ are the *metasemicontinuous* functions in the sense of the papers under view; but the definition of the authors is more complicated and involves the so-called *Aleksandrov set system*. Then define $K(X) \subset H(X)$ to consist of the members of $H(X)$ which vanish outside certain compact subsets of X . $H(X)$ and $K(X)$ are lattice subspaces. With the $\mathfrak{K}(A) := \{K \in \mathfrak{K} : K \subset A\}$ for $A \in \mathfrak{K}$ one has

$$S(\mathfrak{K}) \subset D(\mathfrak{K}) \subset K(X) = \bigcup_{A \in \mathfrak{K}} \overline{D(\mathfrak{K}(A))} \subset H(X).$$

The authors consider the isotone and linear functionals $I : K(X) \rightarrow \mathbb{R}$. We continue with our own reconstruction. From an obvious manipulation combined with the old Kisyński theorem 3.1 we obtain the assertion which follows.

ASSERTION 4.1. *Let $I : K(X) \rightarrow \mathbb{R}$ be isotone and linear. Then there exists a Radon measure $\alpha : \mathfrak{B} \rightarrow [0, \infty]$ such that $I(f) = \int f d\alpha$ for all $f \in K(X)$ (and hence of course a unique one) iff the set function $\phi := I(\chi_{\cdot})|_{\mathfrak{K}}$ is a Radon premeasure. In view of the Kisyński theorem 3.1 this means that*

$$I(\chi_{B \setminus A}) \leq \sup\{I(\chi_K) : K \in \mathfrak{K} \text{ with } K \subset B \setminus A\} \quad \text{for all } A \subset B \text{ in } \mathfrak{K}.$$

Proof. 1) For fixed $A \in \mathfrak{K}$ the restriction $I|_{\overline{D(\mathfrak{K}(A))}}$ is an isotone linear functional on the linear subspace $\overline{D(\mathfrak{K}(A))} \subset K(X)$. One has $\chi_A \in \overline{D(\mathfrak{K}(A))}$. For $f \in \overline{D(\mathfrak{K}(A))}$ therefore $|f| \leq \|f\| \chi_A$ implies that $|I(f)| \leq \|f\| I(\chi_A)$. Thus $I|_{\overline{D(\mathfrak{K}(A))}}$ is supnorm continuous. 2) Let $\alpha : \mathfrak{B} \rightarrow [0, \infty]$ be a Radon measure. The relation $I(f) = \int f d\alpha$ for all $f \in K(X)$ means that for each fixed $A \in \mathfrak{K}$ one has $I(f) = \int f d\alpha$ for all $f \in \overline{D(\mathfrak{K}(A))}$, that is after 1) for all $f \in D(\mathfrak{K}(A))$, that is for all $f \in S(\mathfrak{K}(A))$. Thus one ends up with $I(f) = \int f d\alpha$ for all $f \in S(\mathfrak{K})$, which says that $\phi(K) := I(\chi_K) = \alpha(K)$ for all $K \in \mathfrak{K}$. \square

After this one notes with surprise that Zakharov-Mikhalev [13]-[16] did not characterize the representable functionals $I : K(X) \rightarrow \mathbb{R}$ by the simple Kisyński type condition of 4.1, but by means of a much more complicated equivalent condition. In fact, their condition consists of the two parts

- 1) I is σ continuous under monotone pointwise convergence; and
 2) each sequence $(A(l))_l$ in $\mathfrak{R}(\mathfrak{K})$ which decreases $A(l) \downarrow A \subset X$ satisfies

$$\lim_{l \rightarrow \infty} I(\chi_{A(l)}) \leq \sup\{I(\chi_K) : K \in \mathfrak{K} \text{ with } K \subset A\},$$

once more in simplified form, with $\mathfrak{R}(\mathfrak{K})$ the ring generated by \mathfrak{K} .

The comparison with 4.1 makes clear that this equivalent condition is inadequate in depth in both parts.

This adds to the fact that the basic set-up in the papers under view, that is the limitation to $S(\mathfrak{K}) \subset D(\mathfrak{K}) \subset K(X)$, appears to be much too narrow. Thus one more surprise is the sheer extent of the papers. To be sure, there are other conclusions, but the equivalence described above forms their central result.

ACKNOWLEDGEMENT

Part of the present work has been done while the author visited the Mathematical Research Institute Oberwolfach in September/October 1999. He wants to express his warmest thanks to the Institute and its director, Professor Matthias Kreck.

REFERENCES

- [1] N. Bourbaki, *Intégration*, Chap. IX. Hermann 1969.
- [2] J. Kiszyński, On the generation of tight measures. *Studia Math.* 30 (1968), 141-151.
- [3] H. König, *Measure and Integration: An Advanced Course in Basic Procedures and Applications*. Springer 1997.
- [4] H. König, Image measures and the so-called image measure catastrophe. *Positivity* 1 (1997), 255-270.
- [5] H. König, What are signed contents and measures? *Math.Nachr.* 204 (1999), 101-124.
- [6] H. König, The product theory for inner premeasures. *Note di Mat.* 17 (1997), 235-249.
- [7] H. König, Measure and integration: Comparison of old and new procedures. *Arch. Math.* 72 (1999), 192-205.
- [8] H. König, Measure and integration: Mutual generation of outer and inner premeasures. *Annales Univ. Saraviensis Ser. Math.* 9 (1998), 99-122.
- [9] H. König, Measure and integration: Integral representations of isotone functionals. *Annales Univ. Saraviensis Ser. Math.* 9 (1998), 123-153.
- [10] H. König, Upper envelopes of inner premeasures. To appear in *Annales Inst. Fourier*.
- [11] A. V. Mikhalev and V. K. Zakharov, Solution of Riesz-Radon Problem. In: *Intern. Congress Math. Berlin 1998, Abstracts of Short Comm. and Poster Sess.*, pp. 141-142.
- [12] L. Schwartz, *Radon Measures on Arbitrary Topological Spaces and Cylindrical Measures*. Oxford Univ. Press 1973.

- [13] V. K. Zakharov and A. V. Mikhalev, The Radon problem for regular measures on an arbitrary Hausdorff space (in Russian). *Fund. Prikl. Mat.* 3 (1997), 801-808.
- [14] V. K. Zakharov and A. V. Mikhalev, Integral representation for Radon measures on an arbitrary Hausdorff space (in Russian). *Fund. Prikl. Mat.* 3 (1997), 1135-1172.
- [15] V. K. Zakharov and A.V. Mikhalev, The problem of integral representation for Radon measures on a Hausdorff space (in Russian). *Doklady Akad. Nauk* 360 (1998), 13-15. English translation in *Doklady Math.* 57 (1998), 337-339.
- [16] V. K. Zakharov and A. V. Mikhalev, The problem of general Radon representation for an arbitrary Hausdorff space (in Russian). *Izvestiya Akad. Nauk* 63 (1999), 37-82. English translation in *Izvestiya Math.* 63 (1999), 881-921.
- [17] V. K. Zakharov, A solution of the general Riesz-Radon problem for a Hausdorff space. In: *Intern.Congress Math. Berlin 1998, Abstracts of Short Comm. and Poster Sess.*, p.166.

Heinz König
Universität des Saarlandes,
Mathematik, D-66041
Saarbrücken, Germany
hkoenig@math.uni-sb.de

STABILIZATION OF PERIODS OF EISENSTEIN SERIES AND
BESSEL DISTRIBUTIONS ON $GL(3)$ RELATIVE TO $U(3)$ EREZ LAPID ¹ AND JONATHAN ROGAWSKI ²

Received: February 7, 2000

Revised: June 1, 2000

Communicated by Don Blasius

ABSTRACT. We study the regularized periods of Eisenstein series on $GL(3)$ relative to $U(3)$. A stabilization procedure is used to express the periods in terms of L -functions. This is combined with the relative trace formula Jacquet and Ye to obtain new identities on Bessel distributions.

1991 Mathematics Subject Classification: 11F30, 11F67, 11F70, 11F72

Keywords and Phrases: Eisenstein series, Bessel distributions, periods, stabilization

1 INTRODUCTION

Let G be a reductive group over a number field F and H the fixed point set of an involution θ of G . The *period* of a cusp form ϕ on G is defined as the integral

$$\Pi^H(\phi) = \int_{H(F) \backslash (H(\mathbb{A}) \cap G(\mathbb{A})^1)} \phi(h) dh,$$

known to converge by [AGR]. Recall that a cuspidal representation $\pi = \otimes \pi_v$ of G is said to be *distinguished* by H if there exists an element ϕ in the space V_π of π such that $\Pi^H(\phi) \neq 0$. It is known in some cases that the period factors as a product of local H_v -invariant functionals, even when there is no local uniqueness for such functionals (cf. [J2]), and that it is related to special

¹Supported by NSF Grant DMS 97-29992

²Partially supported by NSF Grant 9700950

values of L -functions. Periods of more general automorphic forms, such as an Eisenstein series, are also of interest. Although the above integral need not converge, it should be possible to regularize it, as has been carried out in [JLR] and [LR] when (G, H) is a Galois pair, i.e., when H is the fixed point set of a Galois involution on G . The regularized period of cuspidal Eisenstein series was computed for the pair $(GL(n)_E, GL(n)_F)$ in [JLR]. It is either identically zero or can be expressed as a ratio of Asai L -functions (up to finitely many local factors at the ramified places). In general, however, the result will be more complicated.

In this paper we study the pair $(GL(3)_E, U(3))$ in detail in order to illustrate some phenomena which are likely to appear in the general case. Our goal is two-fold. First, we introduce a stabilization procedure to express the period of an Eisenstein series induced from a Borel subgroup as a sum of terms, each of which is factorizable with local factors given almost everywhere by ratios of L -factors. This is reminiscent of the procedure carried out in [LL] for the usual trace formula. Second, we define a stable version of the relative Bessel distributions occurring in the relative trace formula developed by Jacquet-Ye. We then use the comparison of trace formulae carried out in [JY] to prove some identities between our stable relative Bessel distributions on $GL(3)_E$ and Bessel distributions on $GL(3)_F$.

The main motivation for this work comes from the relative trace formula (RTF), introduced by Jacquet to study distinguished representations. One expects in general that the distinguished representations are precisely those in the image of a functorial lifting from a group G' determined by the pair (G, H) . For example, G' is $GL(n)_F$ for the pair $(GL(n)_E, U(n))$. To that end one compares the RTF for G with the Kuznetsov trace formula (KTF) for G' . This was first carried out in [Y] for the group $GL(2)$. The cuspidal contribution to the RTF appears directly as sum of relative Bessel distributions (defined below) attached to distinguished representations of G . It should match term by term with the corresponding sum in the KTF of Bessel distributions attached to cuspidal representations of G' . Examples ([J1], [JY], [GJR]) suggest that the contribution of the continuous spectrum of G can also be written as integrals of relative Bessel distributions built out of regularized periods of Eisenstein series. However, these terms cannot be matched up with the continuous part of the KTF directly. Rather, as we show in our special case, the matching can be carried out using the stable relative Bessel distributions.

We now describe our results in greater detail. Assume from now on that (G, H) is a Galois pair, that is $G = \text{Res}_{E/F} H$ where E/F is a quadratic extension and θ is the involution induced by the Galois conjugation of E/F . We also assume that H is quasi-split. By abuse of notation, we treat G as a group over E , identifying it with H_E . The regularized period of an automorphic form ϕ , also denoted $\Pi^H(\phi)$, can be defined using a certain truncation operator $\Lambda_m^T \phi$ depending on a parameter T in the positive Weyl chamber. For T sufficiently

regular, the integral

$$\int_{H(F)Z \backslash H(\mathbb{A})} \Lambda_m^T \phi(h) dh$$

is a polynomial exponential function of T , i.e., it has the form $\sum p_j(T)e^{\langle \lambda_j, T \rangle}$ for certain polynomials p_j and exponents λ_j . Under some restrictions on the exponents of ϕ , the polynomial $p_0(T)$ is constant and $\Pi^H(\phi)$ is defined to be its value.

When $\phi = E(\varphi, \lambda)$ is a cuspidal Eisenstein series, $\Pi^H(\phi)$ can be expressed in terms of certain linear functionals $J(\eta, \varphi, \lambda)$ called *intertwining periods* ([JLR], [LR]). To describe this, consider for simplicity the case of an Eisenstein series induced from the Borel subgroup $B = TN$. We assume that B, T and N are θ -stable. Given a character χ of $T(E) \backslash T(\mathbb{A}_E)$, trivial on $Z(\mathbb{A}_E)$, and λ in the complex vector space $\mathfrak{a}_{0, \mathbb{C}}^*$ spanned by the roots of G , the Eisenstein series

$$E(g, \varphi, \lambda) = \sum_{\gamma \in B(E) \backslash G(E)} \varphi(\gamma g) e^{\langle \lambda, H(\gamma g) \rangle}$$

converges for $\text{Re } \lambda$ sufficiently positive. Here, as usual, $\varphi : G(\mathbb{A}) \rightarrow \mathbb{C}$ is a smooth function such that $\varphi(bg) = \delta_B(b)^{\frac{1}{2}} \chi(b) \varphi(g)$. According to a result of T. Springer [S], each double coset in $B(E) \backslash G(E) / H(F)$ has a representative η such that $\eta \theta(\eta)^{-1}$ lies in the normalizer $N_G(T)$ of T . Denoting the class of $\eta \theta(\eta)^{-1}$ in the Weyl group W by $[\eta \theta(\eta)^{-1}]$, we obtain a natural map

$$\iota : B(E) \backslash G(E) / H(F) \rightarrow W$$

sending $B(E)\eta H(F)$ to $[\eta \theta(\eta)^{-1}]$. For such η , set

$$H_\eta = H \cap \eta^{-1} B \eta.$$

The intertwining period attached to η is the integral

$$J(\eta, \varphi, \lambda) = \int_{H_\eta(\mathbb{A}_F) \backslash H(\mathbb{A}_F)} e^{\langle \lambda, H(\eta h) \rangle} \varphi(\eta h) dh$$

where dh is a semi-invariant measure on the quotient $H_\eta(\mathbb{A}_F) \backslash H(\mathbb{A}_F)$. The result of [LR] alluded to above is that for suitable χ and λ the integral defining $J(\eta, \lambda, \varphi)$ converges and that

$$\Pi^H(E(\varphi, \lambda)) = \delta_\theta \cdot c \cdot \sum_{\iota(\eta)=w} J(\eta, \varphi, \lambda) \tag{1}$$

where w is the *longest element* in W and $c = \text{vol}(H_\eta(F)Z(\mathbb{A}_F) \backslash H_\eta(\mathbb{A}_F))$. Here, δ_θ is 1 if θ acts on \mathfrak{a}_0^* as $-w$ and it is 0 otherwise.

If $G = GL(2)_E$ and $H = GL(2)_F$, $\iota^{-1}(w)$ consists of a single coset $B(E)\eta H(F)$ and $\Pi^H(E(\varphi, \lambda))$ is either zero or proportional to $J(\eta, \varphi, \lambda)$. More generally, if

$G = GL(n)_E$ and $H = GL(n)_F$, the regularized period of a cuspidal Eisenstein series is either zero or is proportional to a single intertwining period. This intertwining period factors as a product of local integrals which are equal almost everywhere to a certain ratio of Asai L -functions ([JLR]). For general groups, however, the sum in (1) is infinite and $\Pi^H(E(\varphi, \lambda))$ cannot be expressed directly in terms of L -functions. This occurs already for $G = SL(2)_E$ and $H = SL(2)_F$. This is related to the fact that base change is not necessarily one-to-one for induced representations. See [J2] for a discussion of the relation between non-uniqueness of local H -invariant functionals and the non-injectivity of base change for the pair $(GL(3)_E, U(3))$.

For the rest of this paper, let $G = GL(3)_E$, $G' = GL(3)_F$, and let $H = U(3)$ be the quasi-split unitary group in three variables relative to a quadratic extension E/F and the Hermitian form

$$\Phi = \begin{pmatrix} 0 & 0 & -1 \\ 0 & -1 & 0 \\ -1 & 0 & 0 \end{pmatrix}$$

Let T and T' be the diagonal subgroups of G and G' , respectively, and $\text{Nm} : T \rightarrow T'$ the norm mapping. We shall fix a unitary character χ of $T(\mathbb{A}_E)$ which is a base change lifting with respect to Nm of a unitary character of $T'(F)Z'(\mathbb{A}_F)\backslash T'(\mathbb{A}_F)$. We write $\mathcal{B}(\chi) = \{\nu\}$ for the set of four characters of $T'(F)Z'(\mathbb{A}_F)\backslash T'(\mathbb{A}_F)$ such that $\chi = \nu \circ \text{Nm}$. The stable intertwining periods $J^{st}(\nu, \varphi, \lambda)$ are defined in §8. Each functional $J^{st}(\nu, \varphi, \lambda)$ is factorizable and invariant under $H(\mathbb{A}_f)$ where \mathbb{A}_f is the ring of finite adèles. Our first main result is that with a suitable normalization of measures, we have the following

THEOREM 1.

$$\Pi^H(E(\varphi, \lambda)) = \sum_{\nu \in \mathcal{B}(\chi)} J^{st}(\nu, \varphi, \lambda)$$

In particular, this expresses the left-hand side as a sum of factorizable distributions.

In Proposition 3, §7, we show that the local factors at the unramified places are given by ratios of L -functions. This is done by a lengthy calculation which can fortunately be handled using Mathematica. Hence we obtain a description of $\Pi^H(E(\varphi, \lambda))$ in terms of L -functions.

We now describe our results on Bessel distributions. In general, if (π, V) is a unitary admissible representation of $G(\mathbb{A})$ and $L_1, L_2 \in V^*$ are linear functionals, we may define a distribution on the space of compactly-supported, \mathbf{K} -finite functions by the formula

$$O(f) = \sum_{\{\phi\}} L_1(\pi(f)\phi) \overline{L_2(\phi)}$$

where $\{\phi\}$ is an orthonormal basis of V consisting of \mathbf{K} -finite vectors. The sum is then finite and O is independent of the choice of basis. The distributions occurring in the KTF and RTF are all of this type. They are referred to as Bessel distributions and relative Bessel distributions in the two cases, respectively.

In this paper, the representations of G and G' that we consider are all assumed to have trivial central character. Correspondingly we will consider factorizable functions $f = \prod f_v$ (resp. $f' = \prod f'_v$) on $G(\mathbb{A}_E)$ (resp. $G'(\mathbb{A})$) of the usual type such that f_v (resp. f'_v) is invariant under the center Z_v (resp. Z'_v) of G_v (resp. G'_v) for all v . In particular, we define $\pi(f) = \int_{G(E)Z(E)\backslash G(\mathbb{A}_E)} f(g)\pi(g)dg$ and similarly for $\pi'(f')$. The *relative Bessel distribution* attached to a cuspidal representation (π, V_π) of G is defined by

$$\tilde{B}(f, \pi) = \sum_{\{\phi\}} \Pi^H(\pi(f)\phi) \overline{\mathbb{W}(\phi)} \tag{2}$$

and the *Bessel distribution* attached to a cuspidal representation (π', V') of G' is defined by

$$B(f', \pi') = \sum_{\{\phi'\}} \mathbb{W}'(\pi'(f')\phi') \overline{\mathbb{W}'(\phi')}.$$

Here $\{\phi\}$ and $\{\phi'\}$ are orthonormal bases of V and V' , respectively, and $\mathbb{W}(\phi)$ and $\mathbb{W}'(\phi')$ are the Fourier coefficients defined in §2. They depend on the choice of an additive character ψ which will remain fixed.

Jacquet and Ye have studied the comparison between the relative trace formula on G and the Kuznetsov trace formula on G' under the assumption that E splits at all real places of F ([J1], [JY]). They define a local notion of matching functions $f_v \leftrightarrow f'_v$ for all v and prove the identity

$$RTF(f) = KTF(f')$$

for all global function $f = \prod_v f_v$ and $f' = \prod_v f'_v$ such that $f \leftrightarrow f'$. By definition, $f \leftrightarrow f'$ if $f_v \leftrightarrow f'_v$ for all v . It follows from the work of Jacquet-Ye that if $f \leftrightarrow f'$, then

$$\tilde{B}(f, \pi) = B(f', \pi') \tag{3}$$

for any cuspidal representation π' of $G'(\mathbb{A}_F)$ with base change lifting π on $G(\mathbb{A}_E)$. Our goal is to formulate and prove an analogous result for Eisensteinian automorphic representations.

Assume that χ is *unitary* and let

$$I(\chi, \lambda) = \text{Ind}_{B(\mathbb{A}_E)}^{G(\mathbb{A}_E)} \chi \cdot e^{\langle \lambda, H(\cdot) \rangle}$$

be an induced representation of $G(\mathbb{A}_E)$. In this case, we define a relative Bessel distribution in terms of the regularized period as follows:

$$\tilde{B}(f, \chi, \lambda) = \sum_{\{\varphi\}} \Pi^H(E(I(f, \chi, \lambda)\varphi, \lambda)) \overline{\mathbb{W}(\varphi, \lambda)}$$

where $\{\varphi\}$ runs through an orthonormal basis of $I(\chi, \lambda)$ and $\mathcal{W}(\varphi, \lambda) = \mathbb{W}(E(\varphi, \lambda))$. Throughout the paper we will use the notation $\overline{\mathcal{W}}(\cdot, \cdot)$ for the complex conjugate of $\mathcal{W}(\cdot, \cdot)$. For $\nu \in \mathcal{B}(\chi)$, the Bessel distribution is defined by

$$B'(f', \nu, \lambda) = \sum_{\{\varphi'\}} \mathcal{W}'(I(f', \nu, \lambda)\varphi, \lambda) \overline{\mathcal{W}}'(\varphi', \lambda),$$

where $\mathcal{W}'(\varphi', \lambda)$ is defined similarly. However, the equality (3) no longer holds. In fact, it is not well-defined since there is more than one automorphic representation π' whose base change lifting is $I(\chi, \lambda)$. However, for $\nu \in \mathcal{B}(\chi)$ we may define

$$\tilde{B}^{st}(f, \nu, \lambda) = \sum_{\{\varphi\}} J^{st}(\nu, \varphi, \lambda) \overline{\mathcal{W}}(\varphi, \lambda). \quad (4)$$

With this definition, Theorem 1 allows us to write

$$\tilde{B}(f, \chi, \lambda) = \sum_{\nu \in \mathcal{B}(\chi)} \tilde{B}^{st}(f, \nu, \lambda).$$

Our next main result is the following

THEOREM 2. *Assume that the global quadratic extension E/F is split at the real archimedean places. Fix a unitary character χ and $\nu \in \mathcal{B}(\chi)$. Then*

$$\tilde{B}^{st}(f, \nu, \lambda) = B'(f', \nu, \lambda)$$

for all matching functions $f \leftrightarrow f'$.

There is a local analogue of this Theorem. The distributions $\tilde{B}^{st}(f, \nu, \lambda)$ are factorizable. Their local counterparts are defined in terms of Whittaker functionals and local intertwining periods. Let E/F be a quadratic extension of p -adic fields. For any character μ of F^* , set

$$\gamma(\mu, s, \psi) = \frac{L(\mu, s)}{\epsilon(\mu, s, \psi)L(\mu^{-1}, 1-s)}.$$

Denote by ω the character of F^* attached to E/F by class field theory. For any character $\nu = (\nu_1, \nu_2, \nu_3)$ of $T'(F)$ and $\lambda \in i\mathfrak{a}_0^*$, set

$$\gamma(\nu, \lambda, \psi) = \gamma(\nu_1\nu_2^{-1}\omega, s_1, \psi)\gamma(\nu_2\nu_3^{-1}\omega, s_2, \psi)\gamma(\nu_1\nu_3^{-1}\omega, s_3, \psi). \quad (5)$$

with notation as in §2.

THEOREM 3. *Let E/F be a quadratic extension of p -adic fields. There exists a constant $d_{E/F}$ depending only on the extension E/F with the property: for all unitary characters ν of $T'(F)$,*

$$\tilde{B}^{st}(f, \nu, \lambda) = d_{E/F}\gamma(\nu, \lambda, \psi)B'(f', \nu, \lambda).$$

whenever $f \leftrightarrow f'$. Moreover, if E/F is unramified and $p \neq 2$ then $d_{E/F} = 1$.

We determine the constant $d_{E/F}$ for E/F unramified and $p \neq 2$ by taking f to be the identity in the Hecke algebra and directly comparing both sides of the equality. As remarked, this involves an elaborate Mathematica calculation. Determining $d_{E/F}$ in general would require more elaborate calculations which we have not carried out. We remark, however, that in a global situation we do have $\prod d_{E_v/F_v} = 1$.

1.1 ACKNOWLEDGEMENT

The first author would like to thank the Institute for Advanced Study in Princeton for its kind hospitality he enjoyed during the academic year 1998–99.

2 NOTATION

Throughout, E/F will denote a quadratic extension of global or local fields of characteristic zero. In the local case we also consider $E = F \oplus F$. In the global case we make the following assumption on the extension E/F :

$$E \text{ splits at every real place of } F. \quad (6)$$

The character of F attached to E by class field theory will be denoted ω . In the local case, if $E = F \oplus F$, then ω is trivial, and $\text{Nm} : E \rightarrow F$ is the map $(x, y) \rightarrow xy$.

As in the introduction, $H = U(3)$ denotes the quasi-split unitary group with respect to E/F and the Hermitian form Φ , and we set $G = GL(3)_E$ and $G' = GL(3, F)$. We shall fix some notation and conventions for the group G . Similar notation and conventions will be used for G' with a prime added.

We write B for the Borel subgroup of G of upper triangular matrices and $B = TN$ for its Levi decomposition where T is the diagonal subgroup. Let W be the Weyl group of G . The standard maximal compact subgroup of $G(\mathbb{A})$ will be denoted \mathbf{K} . In the local case we write K . We have the Iwasawa decompositions $G(\mathbb{A}) = T(\mathbb{A})N(\mathbb{A})\mathbf{K} = N(\mathbb{A})T(\mathbb{A})\mathbf{K}$. We fix the following Haar measures. Let dn and dt be the Tamagawa measures on $N(\mathbb{A})$ and $T(\mathbb{A})$, respectively. Then $\text{vol}(N(F)\backslash N(\mathbb{A})) = 1$. We fix dk on \mathbf{K} by the requiring $\text{vol}(\mathbf{K}) = 1$. Let dg the Haar measure $dt dn dk$. We define Haar measures for G' and H similarly.

Let α_1, α_2 be the standard simple roots and set $\alpha_3 = \alpha_1 + \alpha_2$. Denote the associated co-roots $\alpha_1^\vee, \alpha_2^\vee, \alpha_3^\vee$. Let \mathfrak{a}_0^* be the real vector space spanned by the roots, and let \mathfrak{a}_0 be the dual space. For $\lambda \in \mathfrak{a}_0^*$ set $s_i = \langle \lambda, \alpha_i^\vee \rangle$ for $i = 1, 2, 3$. If M is a Levi subgroup containing T , let $\mathfrak{a}_M \subset \mathfrak{a}_0$ be the subspace spanned by the co-roots of the split component of the center of M . The map $H : G(\mathbb{A}) \rightarrow \mathfrak{a}_0$ is characterized, as usual, by the condition $e^{\langle \alpha_i, H(ntk) \rangle} = |\alpha_i(t)|$. We write $d(a, b, c)$ for the diagonal element

$$d(a, b, c) = \begin{pmatrix} a & & \\ & b & \\ & & c \end{pmatrix}.$$

If M is a Levi subgroup of G , π is an admissible representation of M (locally or globally) and $\lambda \in \mathfrak{a}_{M, \mathbb{C}}^*$ we write $I(\pi, \lambda)$ for the representation of G unitary induced from the representation $m \rightarrow \pi(m)e^{\langle \lambda, H(m) \rangle}$. In the global case, we let $E(g, \varphi, \lambda)$ be the Eisenstein series on $G(\mathbb{A})$ induced by φ .

If χ is a unitary character of $T(\mathbb{A})$, we identify the induced space $I(\chi) = I(\chi, \lambda)$, with the pre-Hilbert space of smooth functions $\varphi : G(\mathbb{A}) \rightarrow \mathbb{C}$ such that $\varphi(ntg) = \delta_B^{1/2}(t)\chi(t)\varphi(g)$ for $n \in N(\mathbb{A})$ and $t \in T(\mathbb{A})$. We use the notation δ_Q to denote the modulus function of a group Q . The scalar product is given by

$$(\varphi_1, \varphi_2) = \int_{B(\mathbb{A}) \backslash G(\mathbb{A})} \varphi_1(g) \overline{\varphi_2(g)} dg = \int_{\mathbf{K}} \varphi_1(k) \overline{\varphi_2(k)} dk.$$

The representation $I(\chi, \lambda)$ is defined by

$$I(g, \chi, \lambda)\varphi(g') = e^{-\langle \lambda, H(g') \rangle} e^{\langle \lambda, H(g'g) \rangle} \varphi(g'g).$$

It is unitary if $\lambda \in i\mathfrak{a}_0^*$. Similar notation will be used in the local case. Let $w \in W$ and let $w\chi(t) = \chi(wtw^{-1})$. The (unnormalized) intertwining operator

$$M(w, \lambda) : I(\chi, \lambda) \rightarrow I(w\chi, w\lambda)$$

is defined by

$$[M(w, \lambda)\varphi](g) = \int_{(N \cap w^{-1}Nw) \backslash N} \varphi(wng) dn.$$

It is absolutely convergent in a suitable cone and admits a meromorphic continuation in λ .

Let $\mathcal{B}(\chi) = \{\nu\}$ be the set of four Hecke characters of the diagonal subgroup $T'(\mathbb{A}_F)$ of $G'(\mathbb{A}_F)$ such that ν is trivial on the center $Z'(\mathbb{A}_F)$ and $\chi = \nu \circ \text{Nm}$. In the non-archimedean case, let \mathcal{H}_G be the Hecke algebra of compactly-supported, bi- K -invariant functions on G . Let $\hat{f}(\chi, \lambda)$ be the Satake transform, i.e., $\hat{f}(\chi, \lambda)$ is the trace of f acting on $I(\chi, \lambda)$. Define $\mathcal{H}_{G'}$ and $\hat{f}'(\nu, \lambda)$ similarly. We define the base change homomorphism

$$\text{bc} : \mathcal{H}_G \rightarrow \mathcal{H}_{G'}$$

in the usual way. By definition, if $f' = \text{bc}(f)$ then $\hat{f}'(\nu \circ \text{Nm}, \lambda) = \hat{f}'(\nu, \lambda)$ for any unramified character ν of $T'(F)$.

We fix a non-trivial additive character ψ of $F \backslash \mathbb{A}_F$. The ψ -Fourier coefficient of an automorphic form on G is defined by

$$\mathbb{W}(\phi) = \int_{N(E) \backslash N(\mathbb{A}_E)} \phi(n) \overline{\psi_N(n)} dn$$

where

$$\psi_N \left(\begin{pmatrix} 1 & x & * \\ 0 & 1 & y \\ 0 & 0 & 1 \end{pmatrix} \right) = \psi(\text{tr } x + \text{tr } y).$$

The ψ -Fourier coefficient $\mathbb{W}(\phi)$ of an automorphic form on G' is defined in a similar way with respect to the character

$$\psi_{N'}\left(\begin{pmatrix} 1 & x & * \\ 0 & 1 & y \\ 0 & 0 & 1 \end{pmatrix}\right) = \psi(x + y).$$

If $\varphi \in I(\pi, \lambda)$, we set

$$\mathcal{W}(\varphi, \lambda) = \mathbb{W}(E(\varphi, \lambda)).$$

In this paper, we use a different Hermitian form from the one used in [JY]. This forces us to modify the definition of matching functions, namely we have to take a left translate of f by τ where ${}^t\bar{\tau}\tau = \Phi$.

PART I

THE REGULARIZED PERIOD

3 DOUBLE COSETS

Let $\theta : G \rightarrow G$ be the involution

$$\theta(g) = \Phi^{-1} {}^t\bar{g}^{-1}\Phi.$$

Then $H = U(3)$ is the fixed-point set of θ . Note that θ preserves B, T, N and \mathbf{K} . We shall consider the space

$$\mathcal{S}_0 = \{s \in G : \theta(s) = s^{-1}\}$$

and its quotient modulo scalars

$$\mathcal{S} = \{s \in G : \theta(s) = s^{-1}\}/F^*.$$

Remark 1. The space \mathcal{S}_0 is a translate by Φ^{-1} of the space of non-degenerate Hermitian forms. Indeed, $s \in \mathcal{S}_0$ if and only if $\Phi^{-1} {}^t\bar{s} = s\Phi^{-1}$, i.e. $s\Phi^{-1}$ is Hermitian.

The group G acts on \mathcal{S} via $s \rightarrow gs\theta(g)^{-1}$. This is compatible with the action on Hermitian forms. The stabilizer of s is the subgroup

$$H_s = \{g \in G : gs\Phi^{-1} {}^t\bar{g} = \lambda s\phi^{-1} \text{ for some } \lambda \in F^*\}.$$

Thus H_s is the unitary similitude group of the Hermitian form $s\Phi^{-1}$. There are only finitely many equivalence classes of Hermitian forms modulo scalars and hence G has finitely many orbits in \mathcal{S} . We obtain a bijection

$$\coprod_{\{s\}} G/H_s \rightarrow \mathcal{S}$$

$$g \rightarrow gs\theta(g)^{-1}$$

where $\{s\}$ is a set of orbit representatives. In fact, our assumption (6) implies that there is only one orbit.

Consider the B -orbits in \mathcal{S} . According to a result of Springer ([S]), every B -orbit in \mathcal{S} intersects the normalizer $N_G(T)$ of the diagonal subgroup T . Moreover, the map $\mathcal{C} \mapsto \mathcal{C} \cap N_G(T)$ is a bijection between B -orbits of \mathcal{S} and T -orbits of $\mathcal{S} \cap N_G(T)$. Thus we may define a map

$$\iota : B \text{ orbits of } \mathcal{S} \rightarrow W$$

sending \mathcal{C} to the T -coset of $\mathcal{C} \cap N_G(T)$.

Set $w = \Phi$ and regard w as an element of W . We shall be interested in $\iota^{-1}(w)$. Suppose that $\eta \in G(E)$ satisfies

$$\eta\theta(\eta)^{-1} = tw$$

where $t = d(t_1, t_2, t_3) \in T(E)$. In this case, $\theta(tw)tw = 1$, or $\theta(w)tw = \theta(t)^{-1}$, and hence $t_1, t_2, t_3 \in F^*$. If $\alpha \in T(E)$, then

$$\alpha(tw)\theta(\alpha)^{-1} = \alpha(tw)w\bar{\alpha}w^{-1} = (\text{Nm } \alpha)tw \quad (7)$$

since $w = w^{-1}$. This yields the following

LEMMA 1. *There is a bijection (depending on the choice of w)*

$$\iota^{-1}(w) \longleftrightarrow T'(F)/Z'(F) \text{Nm}(T(E))$$

defined by sending \mathcal{C} to $\{t : tw \in \mathcal{C} \cap N_G(T)\}$ modulo $Z'(F) \text{Nm}(T(E))$.

In the local case, $\iota^{-1}(w)$ consists of the open orbits.

Set

$$B_\eta = \eta H \eta^{-1} \cap B$$

and

$$H_\eta = H \cap \eta^{-1} B \eta.$$

Then $B_\eta = \{b \in B : \theta(b) = twbw^{-1}t^{-1}\}$ and hence

$$B_\eta = \{d(a, b, c) : a, b, c \in E^1\}$$

where E^1 is the group of norm one elements in E^* . The subgroup B_η is thus independent of η .

4 FOURIER INVERSION AND STABILIZATION

For E/F a quadratic extension of local fields or number fields, or for $E = F \oplus F$, we set

$$A(F) = T'(F)/Z'(F) \text{Nm}(T(E)).$$

By Lemma 1, $A(F)$ parameterizes the B -orbits in $\iota^{-1}(w)$. Note that $A(F) \simeq (F^*/NE^*)^2$. If $E = F \oplus F$, then $A(F)$ is trivial. In the global case, we define $A(\mathbb{A}_F)$ as the direct sum of the corresponding local groups

$$A(\mathbb{A}_F) = \bigoplus_v A(F_v)$$

where v ranges over all places of F . View $A(F)$ as a subgroup of $A(\mathbb{A}_F)$ embedded diagonally. Note that $[A(\mathbb{A}_F) : A(F)] = 4$.

For an absolutely summable function g on $A(\mathbb{A}_F)$, we may define the Fourier transform

$$\widehat{g}(\kappa) = \sum_{x \in A(\mathbb{A}_F)} \kappa(x) g(x)$$

for any character κ of $A(\mathbb{A}_F)$. Let X be the set of four characters of $A(\mathbb{A}_F)$ trivial on $A(F)$. Then the following Fourier inversion formula holds

$$\sum_{x \in A(F)} g(x) = \frac{1}{4} \sum_{\kappa \in X} \widehat{g}(\kappa).$$

Suppose in addition that g is of the form

$$g(x) = \prod_v g_v(x_v)$$

where g_v is a function on $A(F_v)$ for all v and the infinite product converges absolutely. Define the local Fourier transform

$$\widehat{g}_v(\kappa) = \sum_{x_v \in A(F_v)} \kappa(x_v) g_v(x_v)$$

for any character κ of $A(F_v)$. We shall write κ_v for the restriction of a character $\kappa \in A(\mathbb{A}_F)$ to $A(F_v)$. Then we have the following

LEMMA 2. $\widehat{g}(\kappa) = \prod_v \widehat{g}_v(\kappa_v)$

Proof. Let $\{S_n\}_{n=1}^\infty$ be an ascending sequence of finite sets of places of F whose union is the set of all places of F . For any finite set of places S let $A_S(\mathbb{A}_F)$ be the subgroup of elements $x = (x_v) \in A(\mathbb{A}_F)$ such that $x_v = 1$ for $v \notin S$. By definition,

$$g(x) = \lim_{n \rightarrow \infty} \prod_{v \in S_n} g_v(x_v)$$

and

$$\begin{aligned} \widehat{g}(\kappa) &= \lim_{n \rightarrow \infty} \sum_{x \in A_{S_n}(\mathbb{A}_F)} \kappa(x) g(x) \\ &= \lim_{n \rightarrow \infty} \prod_{v \in S_n} \left(\sum_{x_v \in A(F_v)} \kappa_v(x_v) g_v(x_v) \right) \prod_{v \notin S_n} g_v(1) \\ &= \lim_{n \rightarrow \infty} \left(\prod_{v \in S_n} \widehat{g}_v(\kappa_v) \right) \prod_{v \notin S_n} g_v(1) = \prod_v \widehat{g}_v(\kappa_v) \end{aligned}$$

since $\prod_{v \notin S_n} g_v(1)$ converges to 1 as $n \rightarrow \infty$. \square

5 STABLE LOCAL PERIOD

Let us consider the local case. Fix $\eta \in G(E)$ such that $\eta\theta(\eta)^{-1} = tw$ for some $t \in T(F)$. To define the stable local period, we assume that the inducing character $\chi = (\chi_1, \chi_2, \chi_3)$ satisfies $\chi_j|_{E^1} \equiv 1$. It is shown in [LR] that the integral

$$J(\eta, \varphi, \lambda) = \int_{H_\eta(F) \backslash H(F)} e^{\langle \lambda, H(\eta h) \rangle} \varphi(\eta h) dh$$

where $\varphi \in I(\chi, \lambda)$ converges for $\text{Re } \lambda$ positive enough. Let $\nu = (\nu_1, \nu_2, \nu_3)$ be a character of T' such that $\chi_j = \nu_j \circ \text{Nm}$ for $j = 1, 2, 3$. Set

$$\Delta_{\nu, \lambda}(\eta) = \nu(t)\omega(t_1 t_3) e^{\frac{1}{2} \langle \lambda + \rho, H(t) \rangle}.$$

By (7), we have

$$\Delta_{\nu, \lambda}(\alpha\eta) = \chi(\alpha) e^{\langle \lambda + \rho, H(\alpha) \rangle} \Delta_{\nu, \lambda}(\eta),$$

for all $\alpha \in T(E)$ and the expression

$$\Delta_{\nu, \lambda}(\eta)^{-1} \int_{H_\eta(F) \backslash H(F)} e^{\langle \lambda, H(\eta h) \rangle} \varphi(\eta h) dh \quad (8)$$

depends only on the double coset $B\eta H$ and the measure on $H_\eta(F) \backslash H(F)$. The stable local period is defined to be the distribution

$$J^{st}(\nu, \varphi, \lambda) = \sum_{\iota(\eta)=w} \Delta_{\nu, \lambda}(\eta)^{-1} \int_{H_\eta(F) \backslash H(F)} e^{\langle \lambda, H(\eta h) \rangle} \varphi(\eta h) dh.$$

THE SPLIT CASE

If $E = F \oplus F$, then

$$G(E) = GL_3(F) \times GL_3(F) = G'(F) \times G'(F).$$

In this case, the local period can be expressed in terms of an intertwining operator. We have $\theta(h_1, h_2) = (\vartheta(h_2), \vartheta(h_1))$ where $\vartheta(h) = \Phi^{-1} t h^{-1} \Phi$, and

$$H = \{(h, \vartheta(h)) : h \in G'\}.$$

Furthermore, $B(E) \backslash G(E) / H(F) \simeq W$, so the stabilization is trivial. We can take $\eta = (1, w)$. Then $H_\eta = \{(t, \vartheta(t)) : t \in T'\}$.

Let ν be a unitary character of T' . Its base change to T is $\chi = (\nu, \nu)$. Let $\varphi = \varphi_1 \otimes \varphi_2 \in I(\nu \otimes \nu, (\lambda, \lambda)) = I'(\nu, \lambda) \otimes I'(\nu, \lambda)$. Recall that K' is the standard maximal compact subgroup of $G'(F)$.

PROPOSITION 1. *We have*

$$J^{st}(\nu, \varphi_1 \otimes \varphi_2, \lambda) = \int_{K'} \varphi_1(k) (M(w, \lambda) \varphi_2)(\vartheta(k)) dk.$$

Proof. By definition

$$\begin{aligned} J(\eta, \varphi, \lambda) &= \int_{H_\eta \backslash H} e^{\langle (\lambda, \lambda), H(\eta h) \rangle} \varphi(\eta h) dh \\ &= \int_{T' \backslash G'} e^{\langle \lambda, H(h) + H(w\vartheta(h)) \rangle} \varphi_1(h) \varphi_2(w\vartheta(h)) dh \\ &= \int_{K'} \varphi_1(k) \left(\int_N e^{\langle \lambda, H(w\vartheta(n)) \rangle} \varphi_2(w\vartheta(n)\vartheta(k)) dn \right) dk \\ &= \int_{K'} \varphi_1(k) (M(w, \lambda) \varphi_2)(\vartheta(k)) dk. \end{aligned}$$

as required. □

6 MEROMORPHIC CONTINUATION OF LOCAL PERIODS IN THE p -ADIC CASE

Let E/F be quadratic extension of p -adic fields and let $q = q_F$ be the cardinality of the residue field of F .

PROPOSITION 2. *$J^{st}(\nu, \varphi, \lambda)$ is a rational function in q^λ .*

It suffices to show that each integral $J(\eta, \varphi, \lambda)$ is a rational function in q^λ . We shall follow the discussion in [GPSR], pp. 126–130, where a similar assertion is established for certain zeta integrals.

The key ingredient is a theorem of J. Bernstein, which we now recall. Let V be a vector space of countable dimension over \mathbb{C} , Y an irreducible variety over \mathbb{C} with ring of regular functions $\mathbb{C}[Y]$, and I an arbitrary index set. By a system of linear equations in V^* indexed by $i \in I$ we mean a set of equations for $\ell \in V^*$ of the form $\ell(v_i) = a_i$ where $v_i \in V$ and $a_i \in \mathbb{C}$. Consider an algebraic family Ξ of systems parameterized by Y . In other words, for each $i \in I$ we have functions $v_i(y) \in V \otimes \mathbb{C}[Y]$ and $a_i(y) \in \mathbb{C}[Y]$ defining a system $\Xi_y: \ell(v_i(y)) = a_i(y)$, for each $y \in Y$.

Let $K = \mathbb{C}(Y)$ be the fraction field of $\mathbb{C}[Y]$. If $L \in \text{Hom}_{\mathbb{C}}(V, K)$ and $v(y) \in V \otimes \mathbb{C}[Y]$, then $L(v(y))$ may be viewed as an element of K . We will say that $L \in \text{Hom}_{\mathbb{C}}(V, K)$ is a meromorphic solution of the family Ξ if $L(v_i(y)) = a_i(y)$ for all $i \in I$. Then Bernstein's Theorem is the following statement.

THEOREM 4. *In the above notation, suppose that the system Ξ_y has a unique solution $\ell_y \in V^*$ for all y in some non-empty open set $\Omega \subset Y$ (in the complex topology). Then the family Ξ has a unique meromorphic solution $L \in \text{Hom}_{\mathbb{C}}(V, K)$. Furthermore, outside a countable set of hypersurfaces in Y , $\ell_y(v) = (L(v))(y)$.*

To use the Theorem, we need the following input. Recall that there are 4 open B -orbits in G/H . The next lemma shows that generically each one supports at most one H -invariant functional.

LEMMA 3. (a). *If $\text{Re } \lambda$ is sufficiently positive, then there exists a unique (up to a constant) H -invariant functional ℓ on $I(\chi, \lambda)$ such that $\ell(\varphi) = 0$ if $\varphi|_{B\eta H} = 0$.*

(b). *There exists $\varphi_0 \in I(\chi, \lambda)$ such that $J(\eta, \varphi_0, \lambda) = cq^{n\lambda}$ for some non-zero $c \in \mathbb{C}$ and $n \in \mathbb{Z}$.*

Proof. To prove (a), first note that $J(\eta, \varphi, \lambda)$ defines a non-zero H -invariant functional whenever the integral defining it converges. To prove uniqueness, let $\{\eta_i\}$ be a set of representatives for the open orbits in $B \backslash G/H$ and let V be the H -invariant subspace of $\varphi \in I(\chi, \lambda)$ whose support is contained in the union $\coprod_{\eta_i} B\eta_i H$. The argument in [JLR], pp. 212–213 shows that an H -invariant functional vanishing on V is identically zero if $\text{Re } \lambda$ is sufficiently positive. On the other hand, V decomposes as a direct sum over the η_i 's of $\text{ind}_{H_{\eta_i}}^H(\chi_{\lambda}^{\eta_i})$ where

$$(\chi_{\lambda}^{\eta_i})(h) = \chi(\eta_i h \eta_i^{-1}) e^{\langle \lambda, H(\eta_i h \eta_i^{-1}) \rangle}.$$

It remains to show that the space of H -invariant functionals on $\text{ind}_{H_{\eta_i}}^H(\chi_{\lambda}^{\eta_i})$ is at most one-dimensional. However, the dual of $\text{ind}_{H_{\eta}}^H(\chi_{\lambda}^{\eta})$ is $\text{Ind}_{H_{\eta}}^H((\chi_{\lambda}^{\eta})^{-1})$ and the dimension of H -invariant vectors in the latter is at most one by Frobenius reciprocity.

To prove (b), let V be a small open subgroup of G . The map $B \times H \rightarrow G$ defined by $(b, h) \mapsto b\eta h$ is proper since the stabilizer B_{η} is compact. We infer that the set $U = \eta H \cap B\eta V$ is a small neighborhood of $B_{\eta}\eta$ and hence the weight function $H(x)$ takes the constant value $H(\eta)$ on U . Then we may take for φ_0 any non-negative, non-zero function supported in $B\eta V$. \square

To finish the proof of Proposition 2, let $V = I(\chi)$ and $Y = \mathbb{C}^*$. Then $\mathbb{C}[Y]$ may be identified with the ring of polynomials in $q^{\pm\lambda}$. Fix φ_0, c and n as in Lemma 3 and consider the following conditions on a linear functional $\ell \in V^*$:

1. ℓ is H -invariant, i.e. $\ell(I(h, \chi, \lambda)\varphi - \varphi) = 0$ for all φ and $h \in H$.

- 2. $\ell(\varphi) = 0$ if $\varphi|_{B\eta H} = 0$.
- 3. $\ell(\varphi_0) = cq^{n\lambda}$.

These conditions form an algebraic family of systems of linear equations as above. The functional $J(\eta, \varphi, \lambda)$ converges for $\text{Re } \lambda > \lambda_0$ and it is the unique solution for the system by Lemma 3. The proposition now follows from Bernstein's Theorem.

7 UNRAMIFIED COMPUTATION

Suppose now that E/F is an unramified extension of p -adic fields with $p \neq 2$ and that χ is unramified. Let φ_0 be the K -invariant section of $I(\chi, \lambda)$ such that $\varphi_0(e) = 1$. Recall that $s_i = \langle \lambda, \alpha_i^\vee \rangle$ for $i = 1, 2, 3$. Recall our convention that the Haar measure dh on $H(F)$ is defined via the Iwasawa decomposition and assigns measure one to K_H . In the following Proposition, we assume that the measure on $H_\eta(F) \backslash H(F)$ is the quotient of the dh by the measure on $H_\eta(F)$ such that $\text{vol}(H_\eta(F)) = 1$.

PROPOSITION 3. *The stable local period $J^{st}(\nu, \varphi_0, \lambda)$ is equal to*

$$\frac{L(\nu_1\nu_2^{-1}\omega, s_1)L(\nu_2\nu_3^{-1}\omega, s_2)L(\nu_1\nu_3^{-1}\omega, s_3)}{L(\nu_1\nu_2^{-1}, s_1 + 1)L(\nu_2\nu_3^{-1}, s_2 + 1)L(\nu_1\nu_3^{-1}, s_3 + 1)}$$

Sketch of proof. Without loss of generality we may assume that $\chi = 1$. Let $\eta_1, \eta_2, \eta_3, \eta_4$ be the matrices

$$\begin{pmatrix} \frac{1}{2} & 0 & 1 \\ 0 & 1 & 0 \\ -\frac{1}{2} & 0 & 1 \end{pmatrix}, \begin{pmatrix} \frac{\epsilon}{2} & 0 & 1 \\ 0 & 1 & 0 \\ -\frac{1}{2} & 0 & \epsilon^{-1} \end{pmatrix}, \begin{pmatrix} \frac{\epsilon}{2} & 0 & 1 \\ -\frac{1}{2} & 0 & \epsilon^{-1} \\ 0 & -1 & 0 \end{pmatrix}, \begin{pmatrix} 0 & -1 & 0 \\ \frac{\epsilon}{2} & 0 & 1 \\ -\frac{1}{2} & 0 & \epsilon^{-1} \end{pmatrix}$$

respectively, where $\epsilon \in F^* - NE^*$, e.g., ϵ has odd valuation. They form a set of representatives for the double cosets in $B \backslash G/H$ over w . The matrices $\eta_i\theta(\eta_i)^{-1}$ are

$$\begin{pmatrix} & & 1 \\ & 1 & \\ -1 & & \end{pmatrix}, \begin{pmatrix} & & \epsilon \\ & 1 & \\ -\epsilon^{-1} & & \end{pmatrix}, \begin{pmatrix} & & \epsilon \\ & -\epsilon^{-1} & \\ 1 & & \end{pmatrix}, \begin{pmatrix} & & 1 \\ & \epsilon & \\ -\epsilon^{-1} & & \end{pmatrix}$$

respectively.
By definition,

$$J^{st}(\nu, \varphi_0, \lambda) = \sum_j I_j$$

where

$$I_j = \Delta_{\nu, \lambda}^{-1}(\eta_j) \int_{H_{\eta_j}(F) \backslash H(F)} e^{\langle \lambda + \rho, H(\eta_j h) \rangle} dh. \tag{9}$$

Since $H_{\eta_j}(F)$ has measure one, we may use Iwasawa decomposition to write I_j as $\Delta_{\nu,\lambda}(\eta_j)^{-1}$ times

$$\sum_n q_E^{2n} \int_E \int_{\bar{\beta}=-\beta} \exp\left(\left\langle \lambda + \rho, H(\eta_j \begin{pmatrix} 1 & x & \frac{x\bar{x}}{2} + \beta \\ 0 & 1 & \bar{x} \\ 0 & 0 & 1 \end{pmatrix} \begin{pmatrix} \varpi^n & & \\ & 1 & \\ & & \overline{\varpi}^{-n} \end{pmatrix} \right\rangle\right) d\beta dx$$

where ϖ is a uniformizer of E and q_E is the cardinality of the residue field of E .

The I_j can be evaluated explicitly. For $j = 2, 3, 4$, the integrands depend only on $v(x)$, $v(\beta)$ and n , but for $j = 1$ it depends also on $v(\frac{x\bar{x}}{4} \pm 1)$. In any case, the integrations and the summation over β , x and n can be computed as geometric series. This is tedious to carry out by hand, especially in the first case, but we did it using Mathematica with the following results. The term I_1 is independent of ν and is equal to

$$\left[1 - q^{-2(s_1+s_2)} - 2q^{-2(1+s_1+s_2)} + q^{-1-2s_1} + q^{-2-2s_2-4s_1} + q^{-1-2s_2} - 2q^{-1-2(s_1+s_2)} - q^{-3-2(s_1+s_2)} + q^{-2-2s_1-4s_2} + q^{-4s_1-4s_2-3} \right] / \quad (10)$$

$$((1 - q^{-2s_1})(1 - q^{-2s_2})(1 - q^{-2(s_1+s_2)})),$$

while

$$I_2 = \nu_1(\epsilon)^{-1} \nu_3(\epsilon) \cdot \frac{q^{-2-s_1-s_2}(1+q)}{1 - q^{-2(s_1+s_2)}},$$

$$I_3 = -\nu_1(\epsilon)^{-1} \nu_2(\epsilon) \cdot \frac{q^{-1-s_1}(1+q)(1 - q^{-2(1+s_1+s_2)})}{(1 - q^{-2s_1})(1 - q^{-2(s_1+s_2)})},$$

$$I_4 = -\nu_2(\epsilon)^{-1} \nu_3(\epsilon) \cdot \frac{q^{-1-s_2}(1+q)(1 - q^{-2(1+s_1+s_2)})}{(1 - q^{-2s_2})(1 - q^{-2(s_1+s_2)})}$$

respectively. Summing up the contributions (also done with Mathematica) we get

$$\frac{(1 - q^{-(s_1+1)})(1 - q^{-(s_2+1)})(1 - q^{-(s_1+s_2+1)})}{(1 + q^{-s_1})(1 + q^{-s_2})(1 + q^{-(s_1+s_2)})} \quad \text{for } \nu_1 = \nu_2 = \nu_3 = 1$$

$$\frac{(1 - q^{-(s_1+1)})(1 + q^{-(s_2+1)})(1 + q^{-(s_1+s_2+1)})}{(1 + q^{-s_1})(1 - q^{-s_2})(1 - q^{-(s_1+s_2)})} \quad \text{for } \nu_1 = \nu_2 = \omega, \nu_3 = 1$$

$$\frac{(1 + q^{-(s_1+1)})(1 + q^{-(s_2+1)})(1 - q^{-(s_1+s_2+1)})}{(1 - q^{-s_1})(1 - q^{-s_2})(1 + q^{-(s_1+s_2)})} \quad \text{for } \nu_1 = \nu_3 = \omega, \nu_2 = 1$$

$$\frac{(1 + q^{-(s_1+1)})(1 - q^{-(s_2+1)})(1 + q^{-(s_1+s_2+1)})}{(1 - q^{-s_1})(1 + q^{-s_2})(1 - q^{-(s_1+s_2)})} \quad \text{for } \nu_2 = \nu_3 = \omega, \nu_1 = 1$$

as required. □

Remark 2. We have also computed $J^{st}(\nu, \varphi_0, \lambda)$ when E/F is ramified but ν is unramified and $-1 \in \text{Nm } E^*$. In this case the matrices η_i still provide representatives for $B \backslash G/H$. We find that $J^{st}(\nu, \varphi_0, \lambda)$ is equal to

$$\begin{aligned} & 0 \quad \text{for } \nu_1 = \nu_2 = \nu_3 = 1 \\ & \frac{q^{-(s_2+1/2)}(1 - q^{-(s_1+1)})}{(1 - q^{-s_2})(1 - q^{-(s_1+s_2)})} \quad \text{for } \nu_1 = \nu_2 = \omega, \nu_3 = 1 \\ & \frac{q^{-1/2}(1 - q^{-(s_1+s_2+1)})}{(1 - q^{-s_1})(1 - q^{-s_2})} \quad \text{for } \nu_1 = \nu_3 = \omega, \nu_2 = 1 \\ & \frac{q^{-(s_1+1/2)}(1 - q^{-(s_2+1)})}{(1 - q^{-s_1})(1 - q^{-(s_1+s_2)})} \quad \text{for } \nu_2 = \nu_3 = \omega, \nu_1 = 1 \end{aligned}$$

However, this is not sufficient to evaluate $d_{E/F}$. We would also need to determine the function f' on G' that matches φ_0 . Finally if $-1 \notin \text{Nm } E^*$ then the representatives are more difficult to write down and the computation is more elaborate. We have not attempted to do this.

8 STABILIZATION OF PERIODS

We return to the global situation. Let

$$c = \text{vol}(H_\eta(F)Z(\mathbb{A}_F) \backslash H_\eta(\mathbb{A})) = \text{vol}(E^1 \backslash E^1(\mathbb{A}))^2.$$

The following identity

$$\Pi^H(E(\varphi, \lambda)) = c \sum_{\iota(\eta)=w} J(\eta, \varphi, \lambda)$$

is proved in [LR]. It is valid whenever $\text{Re } \lambda$ is positive enough. From now on, we assume that the Haar measure on $H_\eta(\mathbb{A})$ is the Tamagawa measure. This measure has the property that $\text{vol}(H_\eta(F_v)) = 1$ for almost all v and furthermore,

$$c = 4 \tag{11}$$

by Ono's formula for the Tamagawa number of a torus [O]. Fix a character $\nu_0 \in \mathcal{B}(\chi)$ to serve as a base-point. Recall from §4 that the set of double cosets over w is parameterized by the group $A(F)$ both locally and globally. For $a \in A(F)$, let η_a be a representative for the double coset corresponding to a such that $\eta_a \theta(\eta_a)^{-1} = tw$ with $t \in T'(F)$. Fix λ and $\varphi = \otimes \varphi_v \in I(\chi, \lambda) = \otimes I(\chi_v, \lambda)$, and let g_v be the function on $A(F_v)$ defined as follows:

$$g_v(a) = \Delta_{\nu_0, \lambda}(\eta_a)^{-1} \int_{H_{\eta_a}(F_v) \backslash H(F_v)} e^{\langle \lambda, H_v(\eta_a h) \rangle} \varphi_v(\eta_a h) \, dh. \tag{12}$$

The product function $g = \prod_v g_v$ on $A(\mathbb{A})$ is integrable over $A(\mathbb{A}_F)$ for $\operatorname{Re} \lambda$ positive enough. Indeed, Proposition 3 applied to $|\nu_0|$ shows that almost all factors of the integral are local factors of a quotient of products of L -functions. For the same reason, we may define the global stable intertwining period for $\operatorname{Re} \lambda$ positive enough as the absolutely convergent product

$$J^{st}(\nu_0, \varphi, \lambda) = \prod_v J_v^{st}(\nu_{0v}, \varphi_v, \lambda).$$

For any character κ of $A(\mathbb{A})$ trivial on $A(F)$ we have $\widehat{g}(\kappa) = J^{st}(\kappa\nu_0, \varphi, \lambda)$. Observe that the characters $\nu = \kappa\nu_0$ comprise $\mathcal{B}(\chi)$. The Fourier inversion formula of Section 4 together with (11) gives

$$\Pi^H(E(\varphi, \lambda)) = \sum_{\nu \in \mathcal{B}(\chi)} J^{st}(\nu, \varphi, \lambda). \quad (13)$$

By Propositions 1, 2 and 3, each $J^{st}(\nu, \varphi, \lambda)$ admits a meromorphic continuation, and hence, the identity (13) is valid for all λ . These assertions make up Theorem 1, which is now proved.

Remark 3. It seems unlikely that the individual terms $J(\eta, \varphi, \lambda)$ have a meromorphic continuation to the entire complex plane. This is motivated by the following old result of Estermann ([E]). Let $P(x)$ be a polynomial with integer coefficients with $P(0) = 1$. Then either $P(x)$ is a product of cyclotomic polynomials or else the Euler product $\prod_p P(p^{-s})$ has the imaginary axis as its natural boundary. The function $J(\eta, \varphi, \lambda)$ has Euler product where the factors in the inert places are almost always (10).

PART II RELATIVE BESSEL DISTRIBUTIONS

We now turn to the relative Bessel distributions, starting with the local case. Thus we assume that F is a local field. The Whittaker functional is defined by the integral

$$\mathcal{W}(\varphi, \lambda) = \int_N e^{\langle \lambda, H(wn) \rangle} \varphi(wn) \overline{\psi_N(n)} \, dn$$

for $\varphi \in I(\chi, \lambda)$. It converges absolutely for $\operatorname{Re} \lambda$ sufficiently large, and defines a rational function in q^λ .

DEFINITION 1. Let ν be a unitary character of T' which base changes to χ . The stable relative Bessel distribution is defined by

$$\tilde{B}^{st}(f, \nu, \lambda) = \sum_{\varphi} J^{st}(\nu, I(f, \chi, \lambda)\varphi, \lambda) \overline{\mathcal{W}(\varphi, \lambda)}$$

for $\lambda \in i\mathfrak{a}_0^*$ where $\{\varphi\}$ is an orthonormal basis for $I(\chi, \lambda)$.

Similarly, the local Bessel distributions on G' are defined in terms of the Whittaker functionals on G' as follows:

$$B'(f', \nu, \lambda) = \sum_{\varphi'} \mathcal{W}'(I(f', \nu, \lambda)\varphi', \lambda) \overline{\mathcal{W}'}(\varphi', \lambda).$$

Remark 4. Let us check that Theorem 3 is compatible with a change of additive character. In doing this, we include the additive character in the notation. Let ψ' be the character $\psi'(x) = \psi(ax)$. Then $\psi'_N(\cdot) = \psi_N(t_0^{-1} \cdot t_0)$ where $t_0 = d(a^{-1}, 1, a)$, and

$$\mathcal{W}^{\psi'}(\varphi, \lambda) = \chi(wt_0w^{-1})e^{\langle w\lambda + \rho, H(t_0) \rangle} \mathcal{W}^\psi(I(t_0^{-1}, \chi, \lambda)\varphi, \lambda).$$

Hence

$$\tilde{B}_{\psi'}^{st}(f, \nu, \lambda) = \overline{\chi(wt_0w^{-1})}e^{\langle w\bar{\lambda} + \rho, H(t_0) \rangle} \tilde{B}_\psi^{st}(f_{t_0}, \nu, \lambda)$$

where $f_{t_0}(x) = f(xt_0)$. Similarly,

$$B_{\psi'}(f', \nu, \lambda) = |\nu(wt_0w^{-1})e^{\langle w\lambda + \rho, H'(t_0) \rangle}|^2 B_\psi(f'_{t_0}, \nu, \lambda)$$

where $f'_{t_0}(x) = f'(t_0^{-1}xt_0)$. It follows from the definition in [JY] that if $f \leftrightarrow f'$ with respect to ψ then $f_{t_0} \leftrightarrow f'_{t_0}$ with respect to ψ' . On the other hand,

$$\gamma(\nu, \lambda, \psi') = (\nu_1\nu_2^{-1})(a)|a|^{s_1}(\nu_2\nu_3^{-1})(a)|a|^{s_2}(\nu_1\nu_3^{-1})(a)|a|^{s_3}\gamma(\nu, \lambda, \psi).$$

It remains to note that

$$\overline{\chi(wt_0w^{-1})}e^{\langle w\bar{\lambda} + \rho, H(t_0) \rangle} = (\nu_1\nu_2^{-1})(a)|a|^{s_1}(\nu_2\nu_3^{-1})(a)|a|^{s_2}(\nu_1\nu_3^{-1})(a)|a|^{s_3} |\nu(wt_0w^{-1})e^{\langle w\lambda + \rho, H'(t_0) \rangle}|^2.$$

Our goal is to prove Theorems 2 and 3. Let us start with the split case $E = F \oplus F$. By a special case of a result of Shahidi ([Sh]) we have the following local functional equations. For any $\varphi \in I'(\nu, \lambda)$

$$\mathcal{W}(M(w, \lambda)\varphi, w\lambda) = \gamma(\nu, \lambda, \psi)\mathcal{W}(\varphi, \lambda) \tag{14}$$

where $\gamma(\nu, \lambda, \psi)$ is defined in (5). Recall that $\omega \equiv 1$ in this case.

PROPOSITION 4. *We have*

$$\tilde{B}^{st}(f_1 \otimes f_2, \nu, \lambda) = \gamma_v(\nu, \lambda)B'(f, \nu, \lambda)$$

where

$$f(g) = \int_{H(F)} f_1(hg)f_2(\vartheta(h)) dh.$$

Proof. The involution ϑ on G' preserves B', T', N' . It induces the principal involution on the space spanned by the roots. We also let $(\vartheta\varphi)(g) = \varphi(\vartheta(g))$. This is a self-adjoint involution on $I'(\nu)$. By Proposition 1

$$J(\eta, \varphi_1 \otimes \varphi_2, \lambda) = (\vartheta(M(w, \lambda)\varphi_2), \overline{\varphi_1}),$$

and hence

$$\tilde{B}^{st}(f_1 \otimes f_2, \nu, \lambda) \tag{15}$$

is equal to

$$\sum_{i,j} (\vartheta(M(w, \lambda)I'(\nu, f_2, \lambda)\varphi_j), \overline{I'(\nu, f_1, \lambda)\varphi_i}) \times \overline{\mathcal{W}(\varphi_i, \lambda)} \cdot \overline{\mathcal{W}(\varphi_j, \lambda)}.$$

The following identity holds for any operator A , functional l and orthonormal basis $\{e_i\}$ on a Hilbert space:

$$\sum_i (Ae_i, v)\overline{l(e_i)} = \overline{l(A^*v)}.$$

Hence (15) is equal to

$$\sum_i \overline{\mathcal{W}((\vartheta \circ M(w, \lambda)I'(\nu, f_2, \lambda))^* \overline{I'(\nu, f_1, \lambda)\varphi_i}, \lambda)} \overline{\mathcal{W}(\varphi_i, \lambda)} \tag{16}$$

We have the following simple relations

$$\begin{aligned} \mathcal{W}(\vartheta(\varphi), \vartheta(\lambda)) &= \overline{\mathcal{W}(\overline{\varphi}, \overline{\lambda})} \text{ because } \psi_{N'}(\vartheta(n)) = \overline{\psi_{N'}(n)} \\ \vartheta \circ M(w, \lambda) &= M(w, \vartheta(\lambda)) \circ \vartheta \\ \vartheta \circ I'(\nu, f, \lambda) &= I'(\nu, \vartheta(f), \vartheta(\lambda)) \circ \vartheta \\ I'(\nu, f, \lambda)^* &= I'(\nu, f^\vee, -\overline{\lambda}) \text{ where } f^\vee(g) = \overline{f(g^{-1})} \\ M(w, \lambda)^* &= M(w, -w\overline{\lambda}) \end{aligned}$$

We get for any φ ,

$$\begin{aligned} (\vartheta \circ M(w, \lambda)I'(\nu, f_2, \lambda))^* \overline{\varphi} &= (M(w, \vartheta(\lambda))I'(\nu, \vartheta(f_2), \vartheta(\lambda)) \circ \vartheta)^* \overline{\varphi} \\ &= (I'(\nu, \vartheta(f_2), w\vartheta(\lambda))M(w, \vartheta(\lambda))\vartheta)^* \overline{\varphi} \\ &= (\vartheta \circ M(w, -w\overline{\vartheta(\lambda)})I'(\nu, \vartheta(f_2)^\vee, -w\overline{\vartheta(\lambda)})) \overline{\varphi} \\ &= \overline{(\vartheta \circ M(w, \lambda)I'(\nu, \vartheta(f_2^\circ), \lambda))\varphi} \end{aligned}$$

with $f^\circ(g) = f(g^{-1})$. Hence,

$$\begin{aligned} &\overline{\mathcal{W}((\vartheta \circ M(w, \lambda)I'(\nu, f_2, \lambda))^* \overline{I'(\nu, f_1, \lambda)\varphi_i}, \lambda)} \\ &= \overline{\mathcal{W}(\vartheta \circ M(w, \lambda)I'(\nu, \vartheta(f_2^\circ), \lambda)I'(\nu, f_1, \lambda)\varphi_i, \lambda)} \\ &= \mathcal{W}(M(w, \lambda)I'(\nu, \vartheta(f_2^\circ), \lambda)I'(\nu, f_1, \lambda)\varphi_i, \overline{\vartheta(\lambda)}) \\ &= \gamma(\nu, \lambda, \psi)\mathcal{W}(I'(\nu, \vartheta(f_2^\circ), \lambda)I'(\nu, f_1, \lambda)\varphi_i, \overline{w\vartheta(\lambda)}) \\ &= \gamma(\nu, \lambda, \psi)\mathcal{W}(I'(\nu, \vartheta(f_2^\circ))^*f_1, \lambda)\varphi_i, -\overline{\lambda}) \end{aligned}$$

and since $\lambda \in i\mathfrak{a}_0^*$, (16) becomes

$$\gamma(\nu, \lambda, \psi) \sum_i \mathcal{W}(I'(\nu, \vartheta(f_2^\circ) * f_1, \lambda) \varphi_i, \lambda) \overline{\mathcal{W}}(\varphi_i, \lambda) = \gamma(\nu, \lambda, \psi) B'(f, \nu, \lambda)$$

as required. □

We next consider the unramified non-archimedean case. Recall that

$$\text{bc} : \mathcal{H}_G \rightarrow \mathcal{H}_{G'}$$

is the base change homomorphism. Proposition 3 gives the following

PROPOSITION 5. *Assume that $f \in \mathcal{H}_G$ and that ν is a unitary, unramified character. Then*

$$\tilde{B}^{st}(f, \nu, \lambda) = \gamma(\nu, \lambda, \psi) B'(\text{bc}(f), \nu, \lambda). \tag{17}$$

Proof. The left hand side is

$$J^{st}(\nu, I(f, \chi, \lambda) \varphi_0, \lambda) \overline{\mathcal{W}}(\varphi_0, \lambda) = \hat{f}(\chi, \lambda) J^{st}(\nu, \varphi_0, \lambda) \overline{\mathcal{W}}(\varphi_0, \lambda).$$

Recall that we may assume that the additive character ψ is unramified. By the formula for the unramified Whittaker functional and Proposition 3

$$J^{st}(\nu, \varphi_0, \lambda) \overline{\mathcal{W}}(\varphi_0, \lambda) = \frac{L(\nu_1 \nu_2^{-1} \omega, s_1) L(\nu_2 \nu_3^{-1} \omega, s_2) L(\nu_1 \nu_3^{-1} \omega, s_3)}{L(\nu_1 \nu_2^{-1}, s_1 + 1) L(\nu_2 \nu_3^{-1}, s_2 + 1) L(\nu_1 \nu_3^{-1}, s_3 + 1)}$$

times

$$\overline{(L(\chi_1 \chi_2^{-1}, s_1 + 1) L(\chi_2 \chi_3^{-1}, s_2 + 1) L(\chi_1 \chi_3^{-1}, s_3 + 1))}^{-1}$$

If μ_0 is a character of F^* , $\mu = \mu_0 \circ Nm$, and $s \in i\mathbb{R}$ we have

$$\begin{aligned} \frac{L(\mu_0 \varpi, s)}{L(\mu_0, s + 1)} \overline{(L(\mu, s + 1))}^{-1} &= \frac{L(\mu_0 \varpi, s)}{L(\mu_0, s + 1)} \overline{(L(\mu_0, s + 1) L(\mu_0 \varpi, s + 1))}^{-1} \\ &= |L(\mu_0, s + 1)|^{-2} \frac{L(\mu_0 \varpi, s)}{L((\mu_0 \varpi)^{-1}, 1 - s)}. \end{aligned}$$

On the other hand

$$\begin{aligned} B'(\text{bc}(f), \nu, \lambda) &= \mathcal{W}'(I'(\nu, \text{bc}(f), \lambda) \varphi'_0) \overline{\mathcal{W}'}(\varphi'_0) \\ &= \widehat{\text{bc}(f)}(\nu, \lambda) |L(\nu_1 \nu_2^{-1}, s_1 + 1) L(\nu_2 \nu_3^{-1}, s_2 + 1) L(\nu_1 \nu_3^{-1}, s_3 + 1)|^{-2} \\ &= \hat{f}(\chi, \lambda) |L(\nu_1 \nu_2^{-1}, s_1 + 1) L(\nu_2 \nu_3^{-1}, s_2 + 1) L(\nu_1 \nu_3^{-1}, s_3 + 1)|^{-2}, \end{aligned}$$

and the statement follows. □

In the global setup we define

$$\tilde{B}^{st}(f, \nu, \lambda) = \prod_v \tilde{B}_v^{st}(f_v, \nu_v, \lambda)$$

for $f = \otimes f_v$. Note that this is compatible with (4). Similarly

$$B'(f', \nu, \lambda) = \prod_v B'_v(f'_v, \nu_v, \lambda).$$

9 THE RELATIVE TRACE FORMULA

The relative trace formula identity, established by Jacquet reads

$$RTF(f) = KTF(f') \tag{18}$$

where

$$RTF(f) = \int_{H \backslash H(\mathbb{A})} \int_{N(E) \backslash N(\mathbb{A}_E)} K_f(h, n) \psi_N(n) \, dh \, dn$$

$$KTF(f') = \int_{N'(F) \backslash N'(\mathbb{A})} \int_{N'(F) \backslash N'(\mathbb{A})} K'_{f'}(n_1, n_2) \psi_{N'}(n_1 n_2) \, dn_1 \, dn_2$$

for f, f' matching. In ([J1]), Jacquet established the following spectral expansion for $RTF(f)$, at least for \mathbf{K} -finite functions f . It is a sum over terms indexed by certain pairs $Q = (M, \pi)$ consisting of a standard Levi subgroup M and a cuspidal representation π of $M(\mathbb{A})$.

If $M = G$, then Q contributes if π is H -distinguished. In this case, the contribution is

$$\sum_{\varphi} \Pi^H(\pi(f)\varphi) \overline{\mathbb{W}(\varphi)}$$

where $\{\varphi\}$ is an orthonormal basis of the space V_{π} of π . We will say that a Hecke character of $GL(1)_E$ is distinguished if it is trivial on $E^1(\mathbb{A})$, that is, it is the base change of a Hecke character of $GL(1)_F$. If M is the Levi factor of a maximal parabolic subgroup, then $\pi = \sigma \otimes \kappa$ where σ is a cuspidal representation of $GL(2)_E$ and κ is a Hecke character of $GL(1)_E$. The pair Q contributes if σ is distinguished relative to some unitary group in two variables relative to E/F in $GL(2)_E$ and κ is distinguished. In this case, the contribution is

$$\int_{i\mathfrak{a}_{\mathbb{P}}^*} \sum_{\varphi} \Pi^H(E(I(f, \pi, \lambda)\varphi, \lambda)) \overline{\mathbb{W}(E(\varphi, \lambda))} \, d\lambda.$$

Finally, if M is the diagonal subgroup, then π is a triple of characters which we denote $\chi = (\chi_1, \chi_2, \chi_3)$. There are two kinds of contributions. The first one,

which we call *fully continuous* is in the case where each χ_j is distinguished. In the notation of relative Bessel distributions, the contribution is

$$\frac{1}{6} \int_{i\mathfrak{a}_0^*} \tilde{B}(f, \chi, \lambda) \, d\lambda.$$

On the other hand, the *residual* contribution comes from triplets χ such that χ_2 is distinguished, $\chi_3(x) = \chi_1(\bar{x})$ but χ_1, χ_3 are not distinguished. Up to a volume factor it is

$$\int_{i(\alpha_3^+)^+} \sum_{\varphi} \int_{H\mathbf{K}} I(f, \chi, \lambda)\varphi(k) \, dk \cdot \overline{W}(\varphi, \lambda) \, d\lambda.$$

Moreover the sum over χ and the integrals are absolutely convergent. The spectral decomposition of the $KT(f')$ is

$$\sum_{M', \pi'} \int_{i\mathfrak{a}_{M'}^*} \sum_{\varphi'} \mathcal{W}'(I(f', \pi', \lambda')\varphi', \lambda) \overline{W}'(\varphi', \lambda) \, d\lambda'.$$

The fully continuous part is

$$\frac{1}{6} \cdot \sum_{\nu} \int_{i\mathfrak{a}_0^*} B'(f', \nu, \lambda) \, d\lambda.$$

There is no contribution from the residual spectrum because the representations occurring in it are not generic, i.e., the ψ -Fourier coefficients of the residual automorphic forms all vanish. This follows from the description of the residual spectrum by Mœglin and Waldspurger ([MW]).

Remark 5. For all $w \in W$, we have $\tilde{B}(f, \chi, \lambda) = \tilde{B}(f, w\chi, w\lambda)$. Indeed, by the functional equation for the Eisenstein series we have

$$\begin{aligned} & \Pi^H(E(I(f, \chi, \lambda)\varphi, \lambda))\overline{W}(\varphi, \lambda) \\ &= \Pi^H(E(M(w, \lambda)I(f, \chi, \lambda)\varphi, w\lambda))\overline{W}(M(w, \lambda)\varphi, w\lambda) \\ &= \Pi^H(E(I(f, w\chi, w\lambda)M(w, \lambda)\varphi, w\lambda))\overline{W}(M(w, \lambda)\varphi, w\lambda). \end{aligned}$$

We may change the orthonormal basis $\{\varphi\}$ to $\{M(w, \lambda)\varphi\}$ because $M(w, \lambda)$ is unitary for $\lambda \in i\mathfrak{a}_0^*$.

A similar remark applies to the other contributions. In particular, all the expressions above depend on Q only up to conjugacy.

Recall that

$$\tilde{B}(f, \chi, \lambda) = \sum_{\nu \in \mathcal{B}(\chi)} \tilde{B}^{st}(f, \nu, \lambda)$$

and therefore

$$\sum_{\varphi} \Pi^H(E(I(f, \chi, \lambda)\varphi, \lambda))\overline{W}(\varphi, \lambda) = \sum_{\nu \in \mathcal{B}(\chi)} \tilde{B}^{st}(f, \nu, \lambda).$$

We shall now prove Theorems 2 and 3 by isolating the term corresponding to ν, λ in the relative trace formula identity. We proceed in several steps.

10 SEPARATION OF CONTINUOUS SPECTRUM

PROPOSITION 6. For any χ and λ and matching functions $f \leftrightarrow f'$,

$$\sum_{\nu \in \mathcal{B}(\chi)} \tilde{B}^{st}(f, \nu, \lambda) = \sum_{\nu \in \mathcal{B}(\chi)} B(f', \nu, \lambda). \quad (19)$$

To prove this, we modify the usual linear independence of characters argument ([L]). In the following lemma, let G be a reductive group over a global field F and S a set of places containing all the archimedean places and the “bad” places of G . Let \mathfrak{X} be a countable set of pairs (M, π) consisting of a Levi subgroup M and a cuspidal representation π of $M(\mathbb{A})$ which is unramified outside S . For each $(M, \pi) \in \mathfrak{X}$ let a subspace $A_\pi \subset i\mathfrak{a}_M^*$ and a continuous function $g_\pi(\cdot)$ on A_π be given. We make the following hypotheses:

1. If $(M_1, \pi_1), (M_2, \pi_2) \in \mathfrak{X}$ with $\pi_1 \neq \pi_2$ and $\lambda_i \in A_{\pi_i}$, $i = 1, 2$, then $I(\pi_1, \lambda_1)^S$ and $I(\pi_2, \lambda_2)^S$ have no sub-quotient in common.
2. If $(M, \pi) \in \mathfrak{X}$, $\lambda, \lambda' \in A_\pi$ and $I(\pi, \lambda)^S \simeq I(\pi, \lambda')^S$ then $g_\pi(\lambda) = g_\pi(\lambda')$.

Let \mathcal{H}^S denote the Hecke algebra of G^S relative to hyperspecial maximal compact subgroups of G_v for $v \notin S$. For $f \in \mathcal{H}^S$ and σ^S an unramified representation of G^S , we set $\hat{f}^S(\sigma^S) = \text{tr}(\sigma^S(f^S))$.

LEMMA 4 (GENERALIZED LINEAR INDEPENDENCE OF CHARACTERS).

Suppose that

$$\sum_{\pi} \int_{A_\pi} |g_\pi(\lambda)| d\lambda < \infty \quad (20)$$

and that for any $f \in \mathcal{H}^S$

$$\sum_{\pi} \int_{A_\pi} \hat{f}^S(I(\pi, \lambda)^S) g_\pi(\lambda) d\lambda = 0 \quad (21)$$

Then $g_\pi(\lambda) = 0$ for all $\pi \in \mathfrak{X}$.

Proof. Let U be any set of places containing at least two places v_1, v_2 with distinct residual characteristics p_1 and p_2 such that $U \cap S = \emptyset$. Each π defines a map

$$T_{\pi, U} : A_\pi \rightarrow G_U^{un}$$

sending λ to $I(\pi, \lambda)_U$. Applying (21) with $f^U = 1$ gives

$$\sum_{\pi} \int_{A_\pi} \hat{f}_U(T_{\pi, U}(\lambda)) g_\pi(\lambda) d\lambda = 0. \quad (22)$$

Let μ_π be the push-forward under $T_{\pi,U}$ of the measure $g_\pi(\lambda)d\lambda$. The Stone-Weierstrass Theorem implies that the image of \mathcal{H}_U under the Satake transform gives a dense set of continuous functions on \widehat{G}_U^{un} relative to the sup norm. Therefore (21) vanishes for all continuous functions on \widehat{G}_U^{un} . The Riesz Representation Theorem implies that

$$\sum_{\pi} \mu_\pi = 0.$$

Let $Z_{\pi,U}$ be the image of $T_{\pi,U}$. Then $\mu_{\pi_1}(Z_{\pi,U}) = 0$ unless $Z_{\pi,U} \supset Z_{\pi_1,U}$. We now claim that for any subset $Z \subset \widehat{G}_U^{un}$ we have

$$\sum_{\pi: Z_{\pi,U}=Z} \mu_\pi = 0. \tag{23}$$

We argue by induction on $\dim Z$ (i.e., $\dim A_\pi$ where $Z = Z_{\pi,U}$). For Z zero dimensional this follows from the fact that the atomic part of μ is $\sum_{\pi:A_\pi=\{0\}} \mu_\pi$. For the induction step, we can assume that there are no π with $\dim A_\pi < \dim Z$. The restriction of μ to Z is then given by the left-hand side of (23), and our claim is proved.

For each place v , let X_v be the group of unramified characters of the maximal split torus T_v in $M_0(F_v)$ where M_0 is a Levi factor of a fixed minimal parabolic subgroup P_0 of $G(F_v)$ (contained in a globally defined minimal parabolic). We identify X_v with the vector space $\mathfrak{a}_v^* = X^*(T_v) \otimes \mathbb{C}$ modulo the lattice $L_v = \frac{2\pi i}{\ln q_v} X^*(T_v)$. Attached to each unramified representation σ of M_v is an orbit of characters in X_v under the Weyl group of M_v . Let λ_σ be a representative of this orbit. Let W_v be the Weyl group of G_v and let W_U be the Weyl group $\prod_{v \in U} W_v$ of G_U . If σ is an unramified representation of G_U , let λ_σ be the element (λ_{σ_v}) in the product $X_U = \prod X_v$. We observe that the natural map $\mathfrak{a}_P^* \rightarrow X_U$ is injective since $\ln p_1$ and $\ln p_2$ are linearly independent over \mathbb{Q} . We identify \mathfrak{a}_P^* with its image in X_U .

We now claim that if $Z_{\pi,U} = Z_{\pi_0,U}$, then there exists an element $w \in W_U$ such that

1. $w\lambda_{\pi_0,U} - \lambda_{\pi,U} \in A_\pi$.
2. $A_\pi = wA_{\pi_0}$.
3. If $x \in A_{\pi_0}$ and $\lambda = w(x + \lambda_{\pi_0,U}) - \lambda_{\pi,U}$, then $T_{\pi,U}(\lambda) = T_{\pi_0,U}(x)$.

To prove this, observe that for each $\lambda \in A_{\pi_0}$, there exist $w_\lambda \in W_U$ and $\lambda' \in A_\pi$ such that

$$w_\lambda(\lambda + \lambda_{\pi_0,U}) = \lambda' + \lambda_{\pi,U}$$

in X_U . There are only finitely many possibilities for w_λ , and hence there exists $w \in W_U$ such that $w_\lambda = w$ for a set of λ whose closure has a non-empty interior.

Since the condition $w_\lambda = w$ is a closed condition, it holds on an open set and hence everywhere on A_{π_0} . Taking $\lambda = 0$ gives (1). Parts (2) and (3) follow. Set $Z = Z_{\pi_0,U}$ for a fixed π_0 . We rewrite (23) as follows:

$$\begin{aligned} \sum_{\pi:Z_{\pi,U}=Z} \int_{A_\pi} \hat{f}_U(T_{\pi,U}(\lambda))g_\pi(\lambda) d\lambda &= \sum_{\pi:Z_{\pi,U}=Z} \int_{A_{\pi_0}} \hat{f}_U(T_{\pi_0,U}(x))g_\pi(\lambda) dx \\ &= \int_{A_{\pi_0}} \hat{f}_U(T_{\pi_0,U}(x)) \left(\sum_{\pi:Z_{\pi,U}=Z} g_\pi(\lambda) \right) dx = 0 \end{aligned}$$

where $\lambda + \lambda_{\pi,U} = w(x + \lambda_{\pi_0,U})$. The sum taken inside the integral is absolutely convergent for almost all λ by Fubini's theorem. It follows that the push-forward to \hat{G}_U^{un} with respect to $T_{\pi_0,U}$ of the measure

$$\left(\sum_{\pi:Z_{\pi,U}=Z} g_\pi(\lambda) \right) dx$$

is zero. We conclude that for almost all $\lambda_0 \in A_{\pi_0}$, we have

$$\sum_{(\pi,\lambda):T_{\pi,U}(\lambda)=T_{\pi_0,U}(\lambda_0)} g_\pi(\lambda) = 0. \tag{24}$$

It remains to prove that g_{π_0} is identically zero. Fix U as above and fix a set $Z = Z_{\pi_0,U}$. Suppose that $g_{\pi_0}(\lambda_0) \neq 0$. Let Y be the set of pairs (π, λ) such that $T_{\pi,U}(\lambda) = T_{\pi_0,U}(\lambda_0)$. We may choose a finite subset $Y' \subset Y$ such that

$$\sum_{Y-Y'} |g_\pi(\lambda)| < |g_{\pi_0}(\lambda_0)|/2.$$

By choosing $U' \supset U$ sufficiently large, we can ensure that $T_{\pi,U'}(\lambda) \neq T_{\pi_0,U'}(\lambda_0)$ for all $(\pi, \lambda) \in Y'$ such that $I(\pi, \lambda)^S$ and $I(\pi_0, \lambda_0)^S$ have distinct unramified constituents. By Assumption (1), this holds if $\pi \neq \pi_0$. Equality (24) for U' yields

$$\sum_{\lambda:T_{\pi_0,U'}(\lambda)=T_{\pi_0,U'}(\lambda_0)} g_{\pi_0}(\lambda) + \sum_{(\pi,\lambda):\pi \neq \pi_0, T_{\pi,U'}(\lambda)=T_{\pi_0,U'}(\lambda_0)} g_\pi(\lambda) = 0. \tag{25}$$

By Assumption (2), the first term is a positive integer multiple of multiple of $g_{\pi_0}(\lambda_0)$. The second term is bounded by $|g_{\pi_0}(\lambda_0)|/2$. This is a contradiction. \square

Proof of Proposition 6. Fix a character χ and let S be a finite set of places containing the archimedean places such that χ and E/F are unramified outside

S . We shall consider functions $f = f_S \otimes f^S$ where f_S is fixed and f^S varies in the Hecke algebra \mathcal{H}^S . Write (18) as an equality

$$RT(f) - KT(f') = 0.$$

Using the fundamental lemma we can write this in the form (21). To apply Lemma 4, we must check that the Assumptions hold. Assumption (1) is a consequence of the classification theorem of Jacquet-Shalika [JS] applied to $GL(3)$. To check Assumption (2), observe that if $I(\pi, \lambda)^S \simeq I(\pi, \lambda')^S$, then $(\pi, \lambda) = (w\pi, w\lambda')$ by [JS]. Remark 5 then implies that $g_\pi(\lambda) = g_\pi(\lambda')$. \square

11 DECOMPOSABLE DISTRIBUTIONS

We still have to derive identities for the individual ν 's in (19). We note that (19) is an equality between sums of four decomposable distributions. We have the following elementary

LEMMA 5. *Let V_1, V_2, V_3 be vector spaces. Consider vectors $x_i, x'_i \in V_1, y_i, y'_i \in V_2, z_i, z'_i \in V_3$ for $i = 1, \dots, n$ such that*

$$\sum_{i=1}^n x_i \otimes y_i \otimes z_i = \sum_{i=1}^n x'_i \otimes y'_i \otimes z'_i.$$

If each of the sets $\{x_i\}, \{y_i\}$ and $\{z_i\}$ is linearly independent, then there exists a permutation σ of $\{1, \dots, n\}$ such that $x'_i \otimes y'_i \otimes z'_i = x_{\sigma(i)} \otimes y_{\sigma(i)} \otimes z_{\sigma(i)}$ for all i .

Proof. The hypothesis implies that the span of $\{x'_i\}$ is equal to the span of $\{x_i\}$, and similarly for the y 's and z 's. In particular, the sets $\{x'_i\}, \{y'_i\}, \{z'_i\}$ are linearly independent. Write $x'_i = \sum_j \alpha_{ij} x_j$. Since the sum $\sum x_j \otimes V_2 \otimes V_3$ is direct, we must have

$$x_j \otimes y_j \otimes z_j = \sum_i \alpha_{ij} x_j \otimes y'_i \otimes z'_i,$$

for all j and hence $y_j \otimes z_j = \sum_i \alpha_{ij} y'_i \otimes z'_i$. Writing y_j and z_j in terms of the linearly independent sets $\{y'_i\}$ and $\{z'_i\}$, we see that α_{ij} is non-zero for exactly one i . \square

We also have the following

LEMMA 6. *For v inert the distributions $\tilde{B}_v^{st}(f, \nu, \lambda), \nu \in \mathcal{B}(\chi)$ are linearly independent for λ generic.*

Proof. Suppose that L' and L_1, \dots, L_n are linear functionals on V_π where (π, V) is an irreducible unitary representation of a reductive group G over a local field. Assume that L' is non-zero and set

$$O_i(f) = \sum_{\{\varphi\} \subset V_\pi} L_i(\pi(f)\varphi) \overline{L'(\varphi)}$$

for $i = 1, \dots, n$. Then the O_i 's are linearly independent distributions if and only if the L_i are linearly independent. Indeed, any relation among the O_i 's would imply that

$$\sum_{\varphi} L(\pi(f)\varphi)\overline{L'(\varphi)} = 0 \quad (26)$$

for some linear combination L of the L_i 's. Fix a compact open K small enough so that $L'|_{V^K} \neq 0$. Then (26) implies that

$$\sum_{\{\varphi\} \subset V^K} L(\pi(f)\varphi)\overline{L'(\varphi)} = 0$$

for any $f \in \mathcal{H}(G, K)$. We can rewrite this as

$$L(\pi(f)\varphi_0) = 0$$

for some $0 \neq \varphi_0 \in V^K$ and all $f \in \mathcal{H}(G, K)$. This implies that $L|_{V^K} = 0$. Thus, in order to prove the Lemma, it suffices to show that the functionals $\{J_v^{st}(\nu_v, \varphi_v, \lambda)\}_{\nu \in \mathcal{B}(\chi)}$ are linearly independent. However, it is clear that $\{J(\eta, \varphi_v, \lambda)\}_{\eta}$ is a linearly independent set in the range of convergence, since they are given by integrals over disjoint open orbits. Confining ourselves to $\varphi \in V^K$ where K is small enough, the condition of linear independence can be expressed in terms of a non-vanishing of some determinant which is a meromorphic function in λ (in fact rational in q^λ). Thus, it holds for generic λ . Finally, in order to prove the same thing for the J_v^{st} , it suffices to check that the matrix of coefficients $(\Delta_{\nu, \lambda}(\eta)^{-1})_{\nu, \eta}$ is non-singular. However the determinant of this matrix is easily seen to be a non-zero constant multiple of a power of q^λ times the determinant of the character table of $A(F_v)$. \square

COROLLARY 1. *There exists a permutation τ_χ of $\mathcal{B}(\chi)$ such that*

$$\tilde{B}^{st}(f, \nu, \lambda) = B'(f', \tau_\chi(\nu), \lambda) \quad (27)$$

for all λ .

Proof. First, as was noted by Jacquet in ([J2], §4) one may use the localization principle to infer that $B'(f', \nu, \lambda)$ depends only on the orbital integrals used in the definition of matching functions, and hence only on f . Choose any two finite places u, u' of F which are inert in E and view each term in the equality

$$\sum_{\nu \in \mathcal{B}(\chi)} \tilde{B}^{st}(f, \nu, \lambda) = \sum_{\nu \in \mathcal{B}(\chi)} B'(f', \nu, \lambda)$$

of Proposition 6 as a decomposable distribution in f with three factors, where the first two factors are the components at u and u' and the third factor is the product of all components away from u and u' . Lemma 6 allows us to apply Lemma 5 to conclude that (27) holds with the permutation a-priori depending on $\lambda \in i\mathfrak{a}_0^*$. Each side of (27) is the restriction to $i\mathfrak{a}_0^*$ of a meromorphic function on $\mathfrak{a}_{0, \mathbb{C}}^*$. Thus, the permutation does not depend on λ , because there are only finitely many of them. \square

12 UNIFORM DISTRIBUTION OF HECKE CHARACTERS

We need to prove that $\tau_\chi(\nu) = \nu$. We first prove a Lemma which is interesting in its own right. Let F be a number field and S a finite set of places including the archimedean ones. We write $S = S_\infty \cup S_f$. Embed \mathbb{R}_+ in $F \otimes_{\mathbb{Q}} \mathbb{R}$ by $x \mapsto 1 \otimes x$. For any ideal I of \mathcal{O}_F let $\phi(I) = |(\mathcal{O}_F/I)^*|$.

LEMMA 7. *Let $\{I_k\}$ be a family of ideals, disjoint from S whose norms $N(I_k)$ tend to ∞ . For each k let X_k be the set of Hecke characters of F which are trivial on \mathbb{R}_+ and whose conductor divides $I_k J$ for some ideal J whose prime factors lie in S . Then for any $f_S \in C_c^\infty(F_S^*)$ we have*

$$1/\phi(I_k) \sum_{\varrho \in X_k} \hat{f}_S(\varrho_S) \rightarrow \lambda_F \int_{\mathbb{R}_+} f_S(t) d^*t$$

where $\lambda_F = \text{vol}(F^*\mathbb{R}_+ \backslash \mathbb{I}_F)$.

Proof. This is a simple application of the trace formula for $L^2(\mathbb{R}_+ F^* \backslash \mathbb{I}_F)$. Let $f = f_S \otimes f_k \in C_c^\infty(\mathbb{I}_F)$ where $f_S \in C_c^\infty(F_S^*)$ is fixed and f_k is the characteristic function of $\{x \in \prod_{v \notin S} \mathcal{O}_v^* : x \equiv 1 \pmod{I_k}\}$. The Poisson summation formula gives

$$\lambda_F \sum_{\gamma} g(\gamma) = \sum_{\varrho} \hat{f}(\varrho) \tag{28}$$

where $g(x) = \int_{\mathbb{R}_+} f(tx) d^*t$. By our choice of f , the sum in the right hand side extends over X_k , and in the left hand side only $\gamma = 1$ contributes provided that k is sufficiently large. \square

By standard methods, this Lemma implies that as $k \rightarrow \infty$, the set of restrictions ϱ_S of the Hecke characters ϱ in X_k is uniformly distributed in the dual of F_S^* . The Lemma carries over immediately to the torus T' , which is a product of copies of the multiplicative group. We shall use this variant to prove the following Corollary. If Q is a finite set of finite places, we denote by \mathcal{U}_Q the space of unramified unitary characters of $T'(F_Q)$ with the usual topology.

COROLLARY 2. *Given a place $w \notin S$, a unitary character $\eta = (\eta_v)_{v \in S_f}$ of $T'(F_{S_f})$ and an open set $U \subset \mathcal{U}_{S_f}$ there exists a Hecke character ϱ of T' which is unramified outside $S \cup \{w\}$ such that $\varrho_{S_f}^{-1} \eta \in U$.*

13 PROOF OF THEOREMS 2 AND 3

We now finish the proofs of Theorem 2 and Theorem 3.

We first prove Theorem 3 by choosing a favorable global situation. Suppose that we are given local data which consists of:

- a quadratic extension E^0/F^0 , and

- a unitary character μ of $T'(F^0)$.

In principle there is also an additive character of F^0 , but we are free to choose it at will by Remark 4. We can find a quadratic extension of number fields E/F and a place v_1 of F such that $E_{v_1}/F_{v_1} \simeq E^0/F^0$. By passing to EK/FK for an appropriate K we can assume in addition that

1. Every real and even place of F splits at E .
2. Let $S_1 = \{v_i\}_{i=1}^l$ be the set (possibly empty) of places of F which ramify over E . Then $E_{v_i}/F_{v_i} \simeq E^0/F^0$. We fix such isomorphisms.

Choose a non-trivial additive character ψ of $F \setminus \mathbb{A}_F$. Let w_1 be an auxiliary place of F which is inert in E with residual characteristic p . Assume that $p \nmid q_{F^0}$. Let $S_2 = \{w_j\}_{j=1}^m$ be the places of F of residual characteristic p . We may also assume that ψ_v is unramified for $v \in S_2$. Set

$$L_p(\eta, s) = \prod_j L_{w_j}(\eta_{w_j}, s)$$

for any Hecke character η .

LEMMA 8. *There exists an open set U_2 of \mathcal{U}_{S_2} such that whenever ν is a Hecke character of T' such that $\nu_{S_2} \in U_2$ we necessarily have $\tau_\chi(\nu) = \nu$ in the notations of Corollary 1.*

To deduce Theorem from Lemma 8, apply Corollary 2 with the following data:

1. $S = S_\infty \cup S_1 \cup S_2$.
2. $\eta_v = \mu$ for $v \in S_1$.
3. $\eta_v = 1$ for $v \in S_2$.
4. $U = U_1 \times U_2$ where U_1 is an open set of \mathcal{U}_{S_1} .
5. $w \notin S$ is any place of F which splits at E .

Corollary 2 implies that there exists a ν such that $\nu_{S_2} \in U_2$ and $\nu_{S_2} \mu^{-1} \in U_1$. In particular, $\tau_\chi(\nu) = \nu$ by our claim. The equality (27) yields the proportionality of the local distributions, i.e.

$$\tilde{B}^{st}(f_v, \nu, \lambda) = c_v(\nu_v, \lambda) B'(f'_v, \nu, \lambda).$$

Let

$$d_v(\nu_v, \lambda) = c_v(\nu_v, \lambda) / \gamma_v(\nu_v, \lambda).$$

A-priori, d_v is a rational function in q^λ depending on ν and λ . In the split case Proposition 4 shows that $d_v(\nu_v, \lambda) = 1$. In the unramified case, the same holds

by Proposition 5 and Remark 4. Thus, by our conditions we have $d_v(\nu_v, \lambda) = 1$ except possibly for $v = v_i$. Since $\prod_v c_v(\nu_v, \lambda) = 1$ we have

$$\prod_i d_{v_i}(\nu_{v_i}, \lambda) = 1. \tag{29}$$

Write $\nu_{v_i}\mu^{-1} = |\cdot|^{\lambda_i}$ with $\lambda_i \in i\mathfrak{a}_0^*$. The relation (29) implies that

$$\prod_i d(\mu, \lambda + \lambda_i) = 1.$$

If $d(\mu, \cdot)$ were not constant this would impose a non-trivial closed condition on the λ_i 's and this would contradict Corollary 2 for an appropriate choice of U_1 . Hence $d(\mu, \cdot)$ is a constant. In fact, $d(\mu, \cdot)$ is an l -th root of unity where l is the cardinality of S_1 above. To show that d is independent of μ as well, let μ_1 be given and apply the same corollary with η as before except that $\eta_{v_i} = \mu_1$. Then (29) implies that $d(\mu)^{l-1}d(\mu_1) = 1$ so that $d(\mu_1) = d(\mu)$ as required.

We now prove Lemma 8. Let $\nu' = \tau_\chi(\nu)$ and let \tilde{S} be a finite set of places of F including the archimedean ones, outside of which E/F , ψ and ν are unramified. We are free to chose \tilde{S} so that $S_2 \cap \tilde{S} = \emptyset$. By applying Proposition 3.2 and Lemma 3.1 of [JY], we may fix matching functions $f_{\tilde{S}} \leftrightarrow f'_{\tilde{S}}$ such that $B'_{\tilde{S}}(f'_{\tilde{S}}, I(\nu', \lambda)) \neq 0$ as a function of λ . Let $f = f_{\tilde{S}} \otimes \mathbf{1}_{K^{\tilde{S}}}$ and $f' = f'_{\tilde{S}} \otimes \mathbf{1}_{K'^{\tilde{S}}}$. Then $B'(f', I(\nu', \lambda)) \neq 0$.

Since we assume that all real places of F split at E , the relation (27) gives

$$D_{\tilde{S}}^\nu(f, \lambda)L_{(1)}^{\tilde{S}}(\nu, \lambda)\overline{L_{(2)}^{\tilde{S}}(\chi, \lambda)} = \gamma_\infty(\nu, \lambda, \psi)D_{\tilde{S}}^{\nu'}(f', \lambda)|L_{(3)}^{\tilde{S}}(\nu', \lambda)|^2 \tag{30}$$

where $D_{\tilde{S}}^\nu, D_{\tilde{S}}^{\nu'}$ are non-zero rational functions in $\tilde{S}^\lambda = \{q^\lambda : q = q_v, v \in \tilde{S}\}$, $L_{(1)}^{\tilde{S}}(\nu, \lambda)$ is the partial L -function computed in Proposition 3 and $L_{(2)}^{\tilde{S}}(\chi, \lambda)$ (resp. $L_{(3)}^{\tilde{S}}(\nu', \lambda)$) is the L -function giving the Fourier coefficient of the Eisenstein series on G (resp. G'), and finally, γ_∞ is the product of the local γ factors (5) of the archimedean places. As is well known,

$$L_{(2)}^{\tilde{S}}(\chi, \lambda) = \left(L^{\tilde{S}}(\chi_1\chi_2^{-1}, s_1 + 1)L^{\tilde{S}}(\chi_2\chi_3^{-1}, s_2 + 1)L^{\tilde{S}}(\chi_1\chi_3^{-1}, s_1 + s_2 + 1) \right)^{-1}$$

and

$$L_{(3)}^{\tilde{S}}(\nu, \lambda) = \left(L^{\tilde{S}}(\nu_1\nu_2^{-1}, s_1 + 1)L^{\tilde{S}}(\nu_2\nu_3^{-1}, s_2 + 1)L^{\tilde{S}}(\nu_1\nu_3^{-1}, s_1 + s_2 + 1) \right)^{-1}.$$

Since $\overline{L_{(2)}^{\tilde{S}}(\chi, \lambda)} = L_{(2)}^{\tilde{S}}(\chi^{-1}, \bar{\lambda})$ and $s_i \in i\mathbb{R}$, we obtain a relation

$$\begin{aligned} & \frac{L^{\tilde{S}}(\nu_1\nu_2^{-1}\omega, s_1)L^{\tilde{S}}(\nu_2\nu_3^{-1}\omega, s_2)L^{\tilde{S}}(\nu_1\nu_3^{-1}\omega, s_1 + s_2)}{L^{\tilde{S}}(\nu_1\nu_2^{-1}, s_1 + 1)L^{\tilde{S}}(\nu_2\nu_3^{-1}, s_2 + 1)L^{\tilde{S}}(\nu_1\nu_3^{-1}, s_1 + s_2 + 1)} \times \\ & (L^{\tilde{S}}(\chi_1^{-1}\chi_2, -s_1 + 1)L^{\tilde{S}}(\chi_2^{-1}\chi_3, -s_2 + 1)L^{\tilde{S}}(\chi_1^{-1}\chi_3, -s_1 - s_2 + 1))^{-1}A_{\tilde{S}}(\lambda) \\ & = \gamma_\infty(\nu, \lambda, \psi)|L^{\tilde{S}}(\nu'_1\nu'_2^{-1}, s_1 + 1)L^{\tilde{S}}(\nu'_2\nu'_3^{-1}, s_2 + 1)L^{\tilde{S}}(\nu'_1\nu'_3^{-1}, s_1 + s_2 + 1)|^{-2} \end{aligned} \tag{31}$$

where $A_{\tilde{S}}(\lambda)$ is a rational function in \tilde{S}^λ . Note that for any Hecke character μ_0 of F which base changes to μ we have

$$L^{\tilde{S}}(\mu, s) = L^{\tilde{S}}(\mu_0, s)L^{\tilde{S}}(\mu_0\omega, s).$$

Hence, by the functional equation

$$\frac{L(\mu_0\omega, s)}{L(\mu_0, s+1) \cdot L(\mu^{-1}, -s+1)} = \epsilon(\mu_0\omega, s)^{-1} |L(\mu_0, s+1)|^{-2}$$

for $s \in i\mathbb{R}$. Working with partial L -functions we obtain the relation

$$\begin{aligned} & \left| L^{\tilde{S}}(\nu_1\nu_2^{-1}, s_1+1) L^{\tilde{S}}(\nu_2\nu_3^{-1}, s_2+1) L^{\tilde{S}}(\nu_1\nu_3^{-1}, s_1+s_2+1) \right|^2 A'_S(\lambda) = \\ & \left| L^{\tilde{S}}(\nu'_1\nu_2^{-1}, s_1+1) L^{\tilde{S}}(\nu'_2\nu_3^{-1}, s_2+1) L^{\tilde{S}}(\nu'_1\nu_3^{-1}, s_1+s_2+1) \right|^2 \end{aligned}$$

where $A'_S(\lambda)$ is also a rational function in \tilde{S}^λ . We will assume now that $\nu' \neq \nu$ and obtain a contradiction. Suppose, to be specific, that $\nu'_1 = \nu_1$ but $\nu'_j = \nu_j\omega$ for $j = 2, 3$. Thus we obtain

$$\begin{aligned} & |L^{\tilde{S}}(\nu_1\nu_2^{-1}, s_1+1) L^{\tilde{S}}(\nu_1\nu_3^{-1}, s_1+s_2+1)|^{-2} A'_S(\lambda) \\ & = |L^{\tilde{S}}(\nu_1\nu_2^{-1}\omega, s_1+1) L^{\tilde{S}}(\nu_1\nu_3^{-1}\omega, s_1+s_2+1)|^{-2} \end{aligned}$$

where $A'_S(\lambda)$ is as before. This implies then that $A'_S(\lambda)$ decomposes into a product of rational functions depending only on s_1 and s_1+s_2 respectively and then the identity is equivalent to two new identities, one of which reads:

$$\left| L^S(\nu_1\nu_2^{-1}, s+1) \right|^2 c(\lambda) = \left| L^S(\nu_1\nu_2^{-1}\omega, s+1) \right|^2$$

where $c(\lambda)$ is a rational function in $q^{\tilde{S}}$. Using the functional equations again and the fact that $s \in i\mathbb{R}$, one can write this in the form

$$L^{\tilde{S}}(\nu_1\nu_2^{-1}, s+1) L^{\tilde{S}}(\nu_1\nu_2^{-1}, s) c_{\tilde{S}}(s) = L^{\tilde{S}}(\nu_1\nu_2^{-1}\omega, s+1) L^{\tilde{S}}(\nu_1\nu_2^{-1}\omega, s)$$

where $c_{\tilde{S}}(s)$ is a rational function in $q^s, q|\tilde{S}$. Note that the γ factors at ∞ cancel because E/F splits at all real places. This relation now holds as an equality of meromorphic functions. For $\text{Re}(s)$ large enough, both sides can be expanded as Dirichlet series and we can compare their p -power coefficients to conclude:

$$L_p(\nu_1\nu_2^{-1}, s) L_p(\nu_1\nu_2^{-1}, s+1) = L_p(\nu_1\nu_2^{-1}\omega, s) L_p(\nu_1\nu_2^{-1}\omega, s+1).$$

This imposes a non-trivial constraint on ν_{S_2} . A similar argument gives the other cases. This proves Lemma 8 and hence finishes the proof of Theorem 3. Theorem 2 is an immediate consequence of Theorem 3 and Corollary 1.

REFERENCES

- [AGR] A. Ash, D. Ginzburg, and S. Rallis, *Vanishing periods of cusp forms over modular symbols*, Math. Ann. 296 (1993), no. 4, 709–723.
- [E] T. Estermann, *On certain functions represented by Dirichlet series*, Proc. London Math. Soc., ser. 2, 27 (1928), 435–448.
- [GPSR] S. Gelbart, I. Piatetski-Shapiro and S. Rallis, *Explicit constructions of automorphic L-functions*, LNM 1254, 1987.
- [GJR] S. Gelbart, H. Jacquet, J. Rogawski, *Generic representations for the unitary group in three variables*, preprint.
- [J1] H. Jacquet, *The continuous spectrum of the relative trace formula for $GL(3)$ over a quadratic extension*, Israel J. Math., 89 (1995), 1–59.
- [J2] H. Jacquet, *Factorization of Period Integrals*, to appear in: J. No. Theory.
- [JLR] H. Jacquet, E. Lapid, J. Rogawski, *Periods of automorphic forms*, Journal AMS 12, No. 1 (1999), 173–240.
- [JS] H. Jacquet and J. Shalika, *On Euler products and the classification of automorphic representations I,II*, Amer. J. Math. 103 (1981), 499–558 and 777–815.
- [JY] H. Jacquet and Y. Ye, *Distinguished representations and quadratic base change for $GL(3)$* , Trans. Amer. Math. Soc. 348, no. 3 (1996), 913–939.
- [LL] J.-P. Labesse and R. P. Langlands, *L-indistinguishability for $SL(2)$* , Canad. J. Math. 31 (1979), no. 4, 726–785.
- [L] R. P. Langlands, *Base change for $GL(2)$* , Ann. of Math. St. 96, Princeton University Press, 1980.
- [LR] E. Lapid and J. Rogawski, *Periods of Eisenstein series: the Galois case*, In preparation.
- [MW1] C. Moeglin and J.-L. Waldspurger, *Décomposition spectrale et séries D'Eisenstein*, Birkhauser 1993.
- [MW] C. Moeglin and J.-L. Waldspurger, *Le Spectre résiduel de $GL(n)$* , Annales Scientifiques de l'École Normale Supérieure 22 (1989) 605–674.
- [O] T. Ono, *On Tamagawa Numbers*, in *Algebraic Groups and Discontinuous Subgroups* (Borel, Mostow, Ed.), Proc. Symp. Pure Math., v. 9, AMS, Providence (1966) 122–132.

- [Sh] F. Shahidi, *On certain L-functions*, Amer. J. Math. 103 (1981), no. 2, 297–355.
- [S] T. Springer, *Some results on algebraic groups with involutions*, in *Algebraic groups and related topics*, Advanced Studies in Pure Mathematics, vol. 6, 1985, 525–543.
- [Y] Y. Ye, *Kloosterman integrals and base change*, J. Reine Angew. Math 400 (1989), 57–121.

Erez Lapid
Department of Mathematics,
The Ohio State University,
231W 18th Avenue,
Columbus OH 43210,
USA
erezl@math.ohio-state.edu

Jonathan Rogawski
Department of Mathematics,
University of California,
Los Angeles, California 90095,
USA
jonr@math.ucla.edu

I_n -LOCAL JOHNSON-WILSON SPECTRA
AND THEIR HOPF ALGEBROIDS

ANDREW BAKER

Received: January 30, 2000

Revised: June 25, 2000

Communicated by Max Karoubi

ABSTRACT. We consider a generalization $\mathcal{E}(n)$ of the Johnson-Wilson spectrum $E(n)$ for which $\mathcal{E}(n)_*$ is a local ring with maximal ideal I_n . We prove that the spectra $E(n)$, $\mathcal{E}(n)$ and $\widehat{E(n)}$ are Bousfield equivalent. We also show that the Hopf algebroid $\mathcal{E}(n)_*\mathcal{E}(n)$ is a free $\mathcal{E}(n)_*$ -module, generalizing a result of Adams and Clarke for KU_*KU .

1991 Mathematics Subject Classification: Primary 55N20 55N22

Keywords and Phrases: Johnson-Wilson spectrum, Hopf algebroid, localization, free module

INTRODUCTION

For each prime p and $n > 0$, the Johnson-Wilson ring spectrum $E(n)$ provides an important example of a p -local periodic ring spectrum. The associated Hopf algebroid $E(n)_*E(n)$ is well known to be flat over $E(n)_*$, but as far as we are aware there is no proof in the literature that it is a free module for every n . Of course, after passage to the I_n -adic completion $\widehat{E(n)}$, and more drastically the I_n -adic completion of $E(n)_*E(n)$ (see [4, 8]), such problems disappear. On the other hand, for the ring spectrum KU , the associated Hopf algebroid KU_*KU was shown to be free over KU_* by Frank Adams and Francis Clarke [3, 2, 6]. Actually their approach has two parallel interpretations: one purely algebraic involving stably numerical polynomials [5]; the other topological in that it makes use of the cofibre sequence

$$\Sigma^2 kU \xrightarrow{t} kU \longrightarrow H\mathbb{Z}$$

induced by the Bott map $t: S^2 \rightarrow kU$ in connective K -theory.

In this paper we demonstrate an analogous result by constructing an $\mathcal{E}(n)_*$ -basis for $\mathcal{E}(n)_*\mathcal{E}(n)$ for a *generalized Johnson-Wilson spectrum* $\mathcal{E}(n)$ whose homotopy ring is the (graded) local ring

$$\mathcal{E}(n)_* = (E(n)_*)_{I_n}.$$

For completeness, in Section 1 we discuss even more general generalized Johnson-Wilson spectra to which appropriate analogues of our results apply, however we only describe the $\mathcal{E}(n)$ case explicitly.

Our main result is the following which has some immediate consequences stated in the Corollary.

THEOREM. $\mathcal{E}(n)_*\mathcal{E}(n)$ is a free $\mathcal{E}(n)_*$ -module on a countably infinite basis.

COROLLARY.

A) For every $\mathcal{E}(n)_*$ -module M_* and $s > 0$,

$$\mathrm{Ext}_{\mathcal{E}(n)_*}^{s,*}(\mathcal{E}(n)_*\mathcal{E}(n), M_*) = 0.$$

In particular,

$$\mathcal{E}(n)^*\mathcal{E}(n) = \mathrm{Hom}_{\mathcal{E}(n)_*}^*(\mathcal{E}(n)_*\mathcal{E}(n), \mathcal{E}(n)_*),$$

and this is a free $\mathcal{E}(n)_*$ -module on an uncountably infinite basis.

B) The $\mathcal{E}(n)$ -module spectrum $\mathcal{E}(n) \wedge \mathcal{E}(n)$ is a countable wedge

$$\mathcal{E}(n) \wedge \mathcal{E}(n) \simeq \bigvee_{\alpha} \Sigma^{2\ell(\alpha)} \mathcal{E}(n),$$

where ℓ is some integer valued function of the index α .

Actually, when $s \geq 2$, $\mathrm{Ext}_{\mathcal{E}(n)_*}^{s,*}(\mathcal{E}(n)_*\mathcal{E}(n), M_*) = 0$ for formal reasons. The statement about $\mathcal{E}(n)^*\mathcal{E}(n)$ follows from a version of the Universal Coefficient Spectral Sequence of Adams [1].

Our approach to constructing a basis follows a line of argument suggested by that of Adams [2] which also has a purely algebraic interpretation in Adams and Clarke [3, 6].

Although the technology of brave new ring spectra applies to generalized Johnson-Wilson spectra [7, 15], we have no need of such structure, except perhaps to ensure the existence of the relevant Universal Coefficient Spectral Sequence mentioned above; alternatively, M. Hopkins has shown that such spectral sequences exist for all multiplicative cohomology theories constructed using the Landweber Exact Functor Theorem.

I would like to thank Francis Clarke, Neil Strickland and the referee for their helpful comments.

1. GENERALIZED JOHNSON-WILSON SPECTRA

Given a prime p and $n \geq 1$ we define *generalized Johnson-Wilson spectra* as follows. Begin with a regular sequence $\mathbf{u}: u_0 = p, u_1, \dots, u_k, \dots$ in BP_* satisfying

$$u_k \in BP_{2(p^k-1)}, \quad (p, u_1, \dots, u_{k-1}) = I_k \triangleleft BP_*,$$

where I_k is actually independent of the choice of generators for BP_* . Of course we have

$$I_k = (p, v_1, \dots, v_{k-1}) = (p, w_1, \dots, w_{k-1}),$$

where v_j and w_j are the Hazewinkel and Araki generators respectively. There is a commutative ring spectrum $BP \langle n; \mathbf{u} \rangle$ for which

$$BP \langle n; \mathbf{u} \rangle_* = \pi_* BP \langle n; \mathbf{u} \rangle = BP_*/(u_j : j \geq n + 1).$$

We will denote by $I_n \triangleleft BP \langle n; \mathbf{u} \rangle_*$ the image of the ideal $I_n \triangleleft BP_*$ under the natural ring homomorphism $BP_* \rightarrow BP \langle n; \mathbf{u} \rangle_*$.

For any multiplicative set $S \subseteq BP \langle n; \mathbf{u} \rangle_*$ containing u_n and having $I_n \cap S = \emptyset$, we can form the localization

$$E(n; \mathbf{u}; S)_* = BP \langle n; \mathbf{u} \rangle_* [S^{-1}].$$

There is a commutative ring spectrum $E(n; \mathbf{u}; S)$ with

$$E(n; \mathbf{u}; S)_* = \pi_* E(n; \mathbf{u}; S) = BP_*/(u_j : j \geq n + 1)[S^{-1}].$$

EXAMPLE 1.1. a) When $S = \{u_n^r : r \geq 1\}$,

$$E(n; \mathbf{u}; \{u_n^r : r \geq 1\})_* = BP \langle n; \mathbf{u} \rangle_* [u_n^{-1}].$$

This ring contains a maximal ideal I_n generated by the image of $I_n \triangleleft BP \langle n; \mathbf{u} \rangle_*$, whose quotient ring is

$$E(n; \mathbf{u}; \{u_n^r : r \geq 1\})_*/I_n = K(n)_*.$$

This is a mild generalization of the original notion of a Johnson-Wilson spectrum. There is also an I_n -adic completion $E(n; \mathbf{u}; \{u_n^r : r \geq 1\})_{I_n}^\wedge$ with homotopy ring $(E(n; \mathbf{u}; \{u_n^r : r \geq 1\})_*)_{I_n}^\wedge$.

b) When $S = BP \langle n; \mathbf{u} \rangle_* - I_n$,

$$E(n; \mathbf{u}; BP \langle n; \mathbf{u} \rangle_* - I_n)_* = (BP \langle n; \mathbf{u} \rangle_*)_{I_n}.$$

This is a (graded) local ring with residue (graded) field

$$E(n; \mathbf{u}; BP \langle n; \mathbf{u} \rangle_* - I_n)_*/I_n = K(n)_*.$$

In all cases we have the following which is a consequence of modified versions of standard arguments based on the Landweber Exact Functor Theorem.

THEOREM 1.2. For each spectrum $E(n; \mathbf{u}; S)$ the following hold.

- a) On the category of BP_*BP -comodules, tensoring with the BP_* -module $E(n; \mathbf{u}; S)_*$ preserves exactness.
- b) $E(n; \mathbf{u}; S)_*E(n; \mathbf{u}; S)$ is a flat $E(n; \mathbf{u}; S)_*$ -module.
- c) $(E(n; \mathbf{u}; S)_*, E(n; \mathbf{u}; S)_*E(n; \mathbf{u}; S))$ is a Hopf algebroid over $\mathbb{Z}_{(p)}$.

Setting $u_k = v_k$, the Hazewinkel generator, for all k , we obtain the standard connective spectrum $BP \langle n \rangle$ and the Johnson-Wilson spectra $E(n)$, $\mathcal{E}(n)$ for which

$$\begin{aligned} \pi_* E(n) &= E(n)_* = BP \langle n \rangle_* [v_n^{-1}], \\ \pi_* \mathcal{E}(n) &= \mathcal{E}(n)_* = (BP \langle n \rangle_*)_{I_n}. \end{aligned}$$

Notice that every unit $u \in \mathcal{E}(n)_*$ has the form

$$(1.1) \quad u = av_n^r + w,$$

where $a \in \mathbb{Z}_{(p)}^\times$ and $w \in I_n$; in particular, $u \in \mathcal{E}(n)_{2(p^n-1)r}$. Of course, unlike the case of $E(n)$, the multiplicative set inverted to form $\mathcal{E}(n)_*$ from $BP\langle n \rangle_*$ is infinitely generated. However, for every such unit u arising in $BP\langle n \rangle_*$, multiplication by $U = \eta_R(u) \in \mathcal{E}(n)_*BP\langle n \rangle$ preserves $\mathcal{E}(n)_*$ -linearly independent sets by courtesy of the following algebraic result (see for example theorem 7.10 of [12]) and Corollary 2.3 which shows that $\mathcal{E}(n)_*BP\langle n \rangle$ is a free $\mathcal{E}(n)_*$ -module.

PROPOSITION 1.3. *Let A be a commutative unital local ring with maximal ideal \mathfrak{m} . Let M be a flat A -module and $(m_i : i \geq 1)$ be a collection of elements in M . Suppose that under the reduction map*

$$q: M \longrightarrow \overline{M} = A/\mathfrak{m} \otimes_A M,$$

the resulting collection $(q(m_i) : i \geq 1)$ of elements in \overline{M} is A/\mathfrak{m} -linearly independent. Then $(m_i : i \geq 1)$ is A -linearly independent in M .

We end this section with some remarks intended to justify working with $\mathcal{E}(n)$ rather than $E(n)$. For algebraic reasons, our proof of E_* -freeness for E_*E only appears to work for $E = \mathcal{E}(n)$ although we conjecture that the result is true for $E = E(n)$. However, there are sound topological reasons for viewing $\mathcal{E}(n)$ as a substitute for $E(n)$. Notice that

$$E(n)_*/I_n = \mathcal{E}(n)_*/I_n = \widehat{E(n)}_*/I_n = K(n)_*.$$

THEOREM 1.4. *The spectra*

$$E(n), \mathcal{E}(n), \widehat{E(n)}$$

are Bousfield equivalent. More generally, the spectra

$$E(n; \mathbf{u}; \{u_n^r : r \geq 1\}), E(n; \mathbf{u}; BP\langle n; \mathbf{u} \rangle_* - I_n), E(n; \mathbf{u}; \{u_n^r : r \geq 1\})_{I_n}^\wedge$$

are Bousfield equivalent.

REMARK 1.5. It is claimed in proposition 5.3 of [10] that $E(n)$ and $\widehat{E(n)}$ are Bousfield equivalent. The proof given there is not correct since the extension $E(n)_* \longrightarrow \widehat{E(n)}_*$ is not faithfully flat because I_n is not contained in the radical of $E(n)_*$. We refer the reader to Matsumura [12], especially theorem 8.14(3), for standard algebraic facts concerning faithful flatness. In the following proof, we provide an alternative argument based on the Landweber Filtration Theorem [11].

Proof. For simplicity we only give the proof for the classical case. Since

$$\widehat{E(n)}_*(X) = \widehat{E(n)}_* \otimes_{E(n)_*} E(n)_*(X),$$

we need only show that $\widehat{E(n)}_*(X) = 0$ implies $E(n)_*(X) = 0$.

Let M_* a BP_*BP -comodule which is finitely generated as a BP_* -module. Then M_* admits a Landweber filtration by subcomodules

$$0 = M_*^{[0]} \subseteq M_*^{[1]} \subseteq \dots \subseteq M_*^{[k]} = M_*$$

such that for each $j = 0, \dots, k$,

$$M_*^{[j]} / M_*^{[j-1]} \cong BP_* / I_{d_j}$$

for some $d_j \geq 0$. The $E(n)_*E(n)$ -comodule

$$\overline{M}_* = E(n)_* \otimes_{BP_*} M_*$$

inherits a filtration by subcomodules

$$0 = \overline{M}_*^{[0]} \subseteq \overline{M}_*^{[1]} \subseteq \dots \subseteq \overline{M}_*^{[k]} = \overline{M}_*$$

satisfying

$$\overline{M}_*^{[j]} / \overline{M}_*^{[j-1]} \cong E(n)_* / I_{d_j},$$

where $E(n)_* / I_{d_j} = 0$ if $d_j > n$. For a BP_* -module N_* ,

$$\widehat{E(n)}_* \otimes_{E(n)_*} E(n)_* \otimes_{BP_*} N_* \cong \widehat{E(n)}_* \otimes_{BP_*} N_*.$$

Then writing $\widehat{N}_* = \widehat{E(n)}_* \otimes_{BP_*} N_*$ we have

$$\widehat{M}_*^{[j]} / \widehat{M}_*^{[j-1]} \cong \widehat{E(n)}_* / I_{d_j}.$$

From this it follows that $\overline{M}_* = 0$ if and only if $\widehat{M}_* = 0$. So $\widehat{E(n)}_*$ is faithfully flat in this sense on $E(n)_*$ -comodules of the form \overline{M}_* for some finitely generated BP_*BP -comodule.

We can extend this to faithful flatness on all BP_*BP -comodules. Such a comodule N_* is the union of its finitely generated subcomodules, by corollary 2.13 of [13]. For each finitely generated subcomodule $M_* \subseteq N_*$, the short exact sequence

$$0 \rightarrow M_* \rightarrow N_* \rightarrow N_* / M_* \rightarrow 0$$

gives rise to the sequences

$$0 \rightarrow \overline{M}_* \rightarrow \overline{N}_* \rightarrow \overline{N_* / M_*} \rightarrow 0,$$

$$0 \rightarrow \widehat{M}_* \rightarrow \widehat{N}_* \rightarrow \widehat{N_* / M_*} \rightarrow 0.$$

Each of these is short exact since by the Landweber Exact Functor Theorem, tensor product over BP_* with either of $E(n)_*$ or $\widehat{E(n)}_*$ is an exact functor on BP_* -comodules. Suppose that $\widehat{N}_* = 0$; then $\widehat{M}_* = 0$, which implies $\overline{M}_* = 0$. Since

$$\overline{N}_* = \varinjlim_{M_* \subseteq N_*} \overline{M}_*,$$

this gives $\overline{N}_* = 0$. Applying this to the case of $N_* = BP_*(X)$ we obtain the Bousfield equivalence of $E(n)$ with $\widehat{E(n)}$.

In the chain of rings $E(n)_* \subseteq \mathcal{E}(n)_* \subseteq \widehat{E(n)}_*$, the extension $\mathcal{E}(n)_* \rightarrow \widehat{E(n)}_*$ is faithfully flat, hence $\mathcal{E}(n)$ and $\widehat{E(n)}$ are also Bousfield equivalent. Alternatively, by the Landweber Exact Functor Theorem, tensoring with $\mathcal{E}(n)_*$ is exact on

BP_*BP -comodules, so the above proof works as well with $\mathcal{E}(n)$ in place of $E(n)$. \square

This result implies that the stable world as seen through the eyes of each of the homology theories $E(n)_*(\)$, $\mathcal{E}(n)_*(\)$ and $\widehat{E(n)}_*(\)$ looks the same; indeed this is true for any generalized Johnson-Wilson spectrum between $BP\langle n \rangle$ and $\mathcal{E}(n)$. The proof of the p -local part of the result of Adams and Clarke [3, 2, 6] also involves working over a (graded) local ring $(KU_*)_{(p)} = \mathbb{Z}_{(p)}[t, t^{-1}]$; of course their result holds over the arithmetically global ring $KU_* = \mathbb{Z}[t, t^{-1}]$.

2. SOME BASES FOR $\mathcal{E}(n)_*BP$ AND $\mathcal{E}(n)_*BP\langle n \rangle$

We first define a useful basis for $\mathcal{E}(n)_*BP$ which projects to a basis for $\mathcal{E}(n)_*BP\langle n \rangle$ under the natural surjective homomorphism of $\mathcal{E}(n)_*$ -algebras

$$q_n : \mathcal{E}(n)_*BP \longrightarrow \mathcal{E}(n)_*BP\langle n \rangle.$$

$\mathcal{E}(n)_*BP$ is the polynomial $\mathcal{E}(n)_*$ -algebra with the standard generators

$$t_k \in \mathcal{E}(n)_{2(p^k-1)}BP$$

induced from those for BP_*BP described by Adams [1], where

$$\mathcal{E}(n)_*BP = \mathcal{E}(n)_*[t_k : k \geq 1].$$

Hence the latter has an $\mathcal{E}(n)_*$ -basis consisting of the monomials

$$t_1^{r_1} \cdots t_\ell^{r_\ell} \quad (0 \leq r_k).$$

The kernel of q_n is the ideal generated by the elements $V_{n+k} = \eta_R(v_{n+k})$ ($k \geq 1$), where η_R is the right unit obtained from the right unit in BP_*BP as the composite

$$BP_* \xrightarrow{\eta_R} BP_*BP \longrightarrow \mathcal{E}(n)_*BP.$$

By well known formulæ for the right unit of BP_*BP , in the ring $\mathcal{E}(n)_*BP$ we have

$$(2.1a) \quad \eta_R(v_{n+k}) = v_n t_k^{p^n} - v_n^{p^k} t_k + \cdots + p t_{n+k}$$

$$(2.1b) \quad \equiv v_n t_k^{p^n} - v_n^{p^k} t_k \pmod{I_n}.$$

Here the undisplayed terms are polynomials over BP_* in t_1, \dots, t_{k-1} .

REMARK 2.1. The main source of difficulty in working with $E(n)$ itself in place of $\mathcal{E}(n)$ seems to arise from the fact that the coefficient of $t_j^{p^n}$ in Equation (2.1) is then only a unit modulo I_n , so we can only use monomials involving the $\eta_R(v_{n+k})$ as part of a basis when working over $\mathcal{E}(n)_*$ rather than just $E(n)_*$. This is used crucially in the proof of Proposition 2.2. Perhaps a careful choice of generators in place of the Hazewinkel or Araki generators would overcome this problem.

We will also require an expression for the right unit on v_n :

$$(2.2) \quad \eta_R(v_n) = v_n + \sum_{1 \leq j \leq n} v_j \theta_j \in \mathcal{E}(n)_*BP,$$

where $\theta_j \in \mathcal{E}(n)_{2(p^n - p^j)}BP$ has the form

$$\theta_j = t_{n-j}^{p^j} \text{ mod } I_n.$$

In particular $\theta_0 = t_n \text{ mod } I_n$. Although the θ_j are not unique, the terms $v_j \theta_j \text{ mod } I_n^2$ are well defined. Notice that if $u \in \mathcal{E}(n)_*$ has the form of Equation (1.1), then for the right unit $\eta_R(u)$ on u ,

$$\eta_R(u) \equiv av_n^r \text{ mod } I_n.$$

Now we will define some elements that will eventually be seen to form a basis for $\mathcal{E}(n)_*BP$. First we introduce the following elements of $\ker q_n$:

$$(2.3a) \quad \kappa_{r_1, \dots, r_k; s_1, \dots, s_\ell} = v_n^{-(s_1 + \dots + s_\ell)} t_1^{r_1} \dots t_k^{r_k} V_{n+1}^{s_1} \dots V_{n+\ell}^{s_\ell},$$

where $0 \leq r_j \leq p^n - 1$ with $r_k \neq 0$ and $\ell > 0$, $s_j \geq 0$ and $s_\ell \neq 0$. We also have the elements

$$(2.3b) \quad \kappa_{r_1, \dots, r_k} = t_1^{r_1} \dots t_k^{r_k},$$

where $0 \leq r_j \leq p^n - 1$ with $r_k \neq 0$. The empty sequence corresponds to the element $\kappa_\emptyset = 1$. There are also elements

$$(2.4) \quad \bar{\kappa}_{r_1, \dots, r_k} = q_n(\kappa_{r_1, \dots, r_k}) \in \mathcal{E}(n)_*BP \langle n \rangle.$$

Next we introduce an increasing multiplicative filtration on $\mathcal{E}(n)_*BP$ (apart from a factor of 2 in the indexing, this is the filtration associated with the Atiyah-Hirzebruch spectral sequence for $\mathcal{E}(n)_*BP$),

$$\mathcal{E}(n)_* = \mathcal{E}(n)_*BP^{[0]} \subseteq \dots \subseteq \mathcal{E}(n)_*BP^{[k]} \subseteq \dots \subseteq \bigcup_{0 \leq j} \mathcal{E}(n)_*BP^{[j]} = \mathcal{E}(n)_*BP.$$

Here the monomial $t_1^{r_1} \dots t_\ell^{r_\ell}$ has exact filtration $\sum_j r_j(p^j - 1)$. Of course each $\mathcal{E}(n)_*BP^{[k]}$ is a finite rank free $\mathcal{E}(n)_*$ -module with the basis consisting of all the elements κ_{r_1, \dots, r_k} it contains. There are also compatible filtrations $\ker q_n^{[k]}$, $\mathcal{E}(n)_*BP \langle n \rangle^{[k]}$ and $K(n)_*BP^{[k]}$ on $\ker q_n$, $\mathcal{E}(n)_*BP \langle n \rangle$ and $K(n)_*BP$. Notice that for $j \geq 0$, V_{n+j} has exact filtration $(p^{n+j} - 1)$; more generally, the elements defined in Equations (2.3) satisfy

$$(2.5) \quad \kappa_{r_1, \dots, r_k; s_1, \dots, s_\ell} \in \mathcal{E}(n)_*BP^{[d]}$$

whenever

$$d \geq \sum_i r_i(p^i - 1) + \sum_j s_j(p^{n+j} - 1).$$

PROPOSITION 2.2. *The elements*

$$(2.6) \quad \begin{cases} \kappa_{r_1, \dots, r_k} & \text{for } 0 \leq r_j \leq p^n - 1, r_k \neq 0, \\ \kappa_{r_1, \dots, r_k; s_1, \dots, s_\ell} & \text{for } 0 \leq r_j \leq p^n - 1, r_k \neq 0, 0 \leq s_j, s_\ell \neq 0, \ell > 0, \end{cases}$$

form an $\mathcal{E}(n)_*$ -basis for $\mathcal{E}(n)_*BP$.

Proof. Since

$$\mathcal{E}(n)_*BP = \bigcup_{j \geq 0} \mathcal{E}(n)_*BP^{[m]}$$

it suffices to show that for each $m \geq 0$, the κ elements specified in Equation (2.6) and also contained in $\mathcal{E}(n)_*BP^{[m]}$ actually form a basis for $\mathcal{E}(n)_*BP^{[m]}$. $\mathcal{E}(n)_*BP^{[m]}$ has a natural basis consisting of all the t monomials $t_1^{r_1} \cdots t_k^{r_k}$ ($r_j \geq 0$) it contains. Notice that the number of κ elements in $\mathcal{E}(n)_*BP^{[m]}$ is the same as the number of such monomials, hence is equal to the rank of $\mathcal{E}(n)_*BP^{[m]}$. Let $M(m)$ be the Gram matrix over $\mathcal{E}(n)_*$ expressing the κ elements in terms of the t monomial basis, with suitable orderings on these elements. It suffices to show that $M(m)$ is invertible, and for this we need to show that $\det M(m)$ is a unit in $\mathcal{E}(n)_*$. As $\mathcal{E}(n)_*$ is local, this is true if $\det M(m) \bmod I_n$ is a unit.

We have

$$(2.7) \quad \begin{aligned} \kappa_{r_1, \dots, r_k; s_1, \dots, s_\ell} &\equiv t_1^{r_1} \cdots t_k^{r_k} (t_1^{p^n} - v_n^{p^n-1} t_1)^{s_1} \cdots (t_\ell^{p^n} - v_n^{p^\ell-1} t_\ell)^{s_\ell} \bmod I_n \\ &\equiv t_1^{r_1+p^n s_1} \cdots t_\ell^{r_\ell+p^n s_\ell} + (\text{terms of lower filtration}) \bmod I_n. \end{aligned}$$

Working modulo I_n in terms of the basis of t monomials, the Gram matrix for the κ elements is lower triangular with all diagonal terms being 1, therefore $\det M(m) \equiv 1 \bmod I_n$. So $\det M(m)$ is a unit and $M(m)$ is invertible. Thus the κ elements of $\mathcal{E}(n)_*BP^{[m]}$ form a basis. □

COROLLARY 2.3. *The short exact sequence of $\mathcal{E}(n)_*$ -modules*

$$0 \rightarrow \ker q_n \rightarrow \mathcal{E}(n)_*BP \xrightarrow{q_n} \mathcal{E}(n)_*BP \langle n \rangle \rightarrow 0$$

splits so there is an isomorphism of $\mathcal{E}(n)_*$ -modules

$$\mathcal{E}(n)_*BP \cong \ker q_n \oplus \mathcal{E}(n)_*BP \langle n \rangle.$$

Also, $\mathcal{E}(n)_*BP \langle n \rangle$ and $\ker q_n$ are free $\mathcal{E}(n)_*$ -modules.

3. $\mathcal{E}(n)_*\mathcal{E}(n)$ AS A LIMIT

In this section we will give a description of $\mathcal{E}(n)_*\mathcal{E}(n)$ as a colimit. Although we proceed algebraically, we note that this limit has topological origins since for each $u \in BP \langle n \rangle_{2(p^n-1)r}$ with $r > 0$ and which is a unit in $\mathcal{E}(n)_*$, there is a cofibre sequence

$$\Sigma^{2(p^n-1)r} BP \langle n \rangle \xrightarrow{u} BP \langle n \rangle \rightarrow BP \langle n-1; u \rangle$$

and $\mathcal{E}(n)$ is the telescope

$$\mathcal{E}(n) = \text{Tel}_u BP \langle n \rangle.$$

On applying the functor $\mathcal{E}(n)_*(\)$, there is a short exact sequence

$$0 \rightarrow \mathcal{E}(n)_*BP \langle n \rangle \xrightarrow{U} \mathcal{E}(n)_*BP \langle n \rangle \longrightarrow \mathcal{E}(n)_*BP \langle n-1; u \rangle \rightarrow 0,$$

and limit

$$\mathcal{E}(n)_*\mathcal{E}(n) \cong \varinjlim_U \mathcal{E}(n)_*BP \langle n \rangle,$$

in which U denotes multiplication by the right unit on u . Since $u \equiv av_n^r \pmod{I_n}$ in the notation of Equation (1.1), application of the functor $K(n)_*(\)$ induces another exact sequence and limit

$$0 \rightarrow K(n)_*BP \langle n \rangle \xrightarrow{U} K(n)_*BP \langle n \rangle \longrightarrow K(n)_*BP \langle n-1; u \rangle = 0, \\ K(n)_*\mathcal{E}(n) \cong \varinjlim_U K(n)_*BP \langle n \rangle.$$

There are also algebraic identities

$$\mathcal{E}(n)_*\mathcal{E}(n) \cong \mathcal{E}(n)_* \otimes_{BP_*} BP_*BP \otimes_{BP_*} \mathcal{E}(n)_*, \\ \mathcal{E}(n)_*BP \langle n \rangle \cong \mathcal{E}(n)_*BP / \ker q_n, \\ K(n)_*BP \langle n \rangle \cong K(n)_* \otimes_{\mathcal{E}(n)_*} \mathcal{E}(n)_*BP \langle n \rangle \cong K(n)_* \otimes_{BP_*} BP_*BP \langle n \rangle,$$

which allow us to work without direct reference to the underlying topology. First we describe a directed system (Λ, \preceq) . Recall that $BP \langle n \rangle_*$ is a graded unique factorization domain, with group of units $BP \langle n \rangle_*^\times = \mathbb{Z}_{(p)}^\times$. Define the sets

$$\Lambda_r = \{(u) \triangleleft BP \langle n \rangle_* : u \in BP \langle n \rangle_{2(p^{n-1})r}, u \in \mathcal{E}(n)_* \text{ is a unit}\} \quad (r \geq 0),$$

$$\Lambda = \bigcup_{r \geq 0} \Lambda_r.$$

We will often abuse notation and identify (u) with a generator u ; this can be made precise by specifying a choice function to select a generator of each such principal ideal. Of course, $(u) = (v)$ if and only if there is a unit $a \in \mathbb{Z}_{(p)}^\times$ for which $u = av$, i.e., if $u \mid v$ and $v \mid u$ in $BP \langle n \rangle_*$. We will write $u \preceq v$ if $(v) \subseteq (u)$, i.e., if $u \mid v$. We will also write $u \prec v$ if $u \preceq v$ and $(u) \neq (v)$. The directed system (Λ, \preceq) is filtered since for $u, v \in \Lambda$, $u \preceq uv$ and $v \preceq uv$.

REMARK 3.1. For later use we will need a cofinal subset of Λ and we now describe some obvious examples. Since $BP \langle n \rangle_*$ is a countable unique factorization domain, we may list the distinct *prime* ideals lying in Λ as $(w_1), (w_2), (w_3), \dots$ say. Now inductively define

$$u_0 = 1, \quad u_k = u_{k-1}^k w_k.$$

Then $u_{k-1} \mid u_k$ and indeed $u_{k-1} \prec u_k$. Also, for every element $(u) \in \Lambda$ there is a k such that $u \mid u_k$, hence $u \preceq u_k$. So the u_k form a cofinal sequence in Λ .

Now form the directed system consisting of pairs of the form $(BP\langle n\rangle_*, u)$ with $u \in \Lambda$. If $u, v \in \Lambda$, the morphism $(BP\langle n\rangle_*, u) \rightarrow (BP\langle n\rangle_*, uv)$ is multiplication by v ,

$$BP\langle n\rangle_* \xrightarrow{v} BP\langle n\rangle_*.$$

On setting $V = \eta_R(v)$, there is also a homomorphism

$$\mathcal{E}(n)_*BP\langle n\rangle \xrightarrow{V} \mathcal{E}(n)_*BP\langle n\rangle.$$

These give rise to limits

$$(3.1) \quad \mathcal{E}(n)_* = \varinjlim_{u \in \Lambda} BP\langle n\rangle_* = (BP\langle n\rangle_*)_{I_n},$$

$$(3.2) \quad \mathcal{E}(n)_*\mathcal{E}(n) = \varinjlim_{u \in \Lambda} \mathcal{E}(n)_*BP\langle n\rangle = (\mathcal{E}(n)_*BP\langle n\rangle)_{\eta_R I_n}.$$

REMARK 3.2. In describing $\mathcal{E}(n)_*\mathcal{E}(n)$ as a limit, it suffices to replace each map V by

$$\mathcal{E}(n)_*BP\langle n\rangle \xrightarrow{v^{-1}V} \mathcal{E}(n)_*BP\langle n\rangle,$$

which is of degree 0 and satisfies

$$(3.3) \quad v^{-1}V \equiv 1 \pmod{I_n}.$$

This will simplify the description of our basis. Notice that if $(v) = (w) \triangleleft BP\langle n\rangle_*$, then

$$v^{-1}V = w^{-1}W,$$

providing another reason for using $v^{-1}V$ in place of V . From now on we will consider $\mathcal{E}(n)_*\mathcal{E}(n)$ as the limit over such maps $v^{-1}V$ rather than the limit of Equation (3.2).

4. SOME BASES FOR $\mathcal{E}(n)_*BP\langle n\rangle$ AND $\mathcal{E}(n)_*\mathcal{E}(n)$

For each pair (u, s) with $u \in \Lambda_r$ and s a non-negative integer, set

$$M(u; s)_* = \mathcal{E}(n)_*BP\langle n\rangle^{[s+r(p^n-1)]}.$$

By Corollary 2.3, $M(u; s)_*$ is free on the images under q_n of the κ_{r_1, \dots, r_k} defined in Proposition 2.2 and we refer to this as the $q_n\kappa$ -basis. There are inclusion maps

$$\text{inc}: M(u; s)_* \rightarrow M(u; s+1)_*.$$

For $v \in \Lambda_t$ and $V = \eta_R(v)$, there is a multiplication by $v^{-1}V$ map

$$v^{-1}V: M(u; s)_* \rightarrow M(uv; s)_*.$$

By Equation (2.2), $v^{-1}V$ raises filtration by $t(p^n - 1)$. Equation (3.3) and Proposition 1.3 imply that $v^{-1}V$ is also injective; indeed we have the following result.

PROPOSITION 4.1. *Let $s \geq 0$ and $u, v \in \Lambda$. The $\mathcal{E}(n)_*$ -submodule*

$$v^{-1}VM(u; s)_* \subseteq M(uv; s)_*$$

is a summand. Furthermore, if \mathcal{B} is a basis for $M(u; s)_$ then $M(uv; s)_*$ has a basis consisting of the elements*

$$v^{-1}Vb \quad (b \in \mathcal{B}), \quad \bar{\kappa}_{r_1, \dots, r_k} \in M(uv; s)_* - v^{-1}VM(u; s)_*.$$

Proof. $M(u; s)_*$ and $M(uv; s)_*$ each have the $q_n \kappa$ -bases. After reduction modulo I_n , the stated elements in $K(n)_*BP \langle n \rangle$ satisfy

$$\begin{aligned} v^{-1}Vb &= b \in K(n)_*BP \langle n \rangle^{[d+s]}, \\ \bar{\kappa}_{r_1, \dots, r_k} &\in K(n)_*BP \langle n \rangle^{[d+h+s]} - K(n)_*BP \langle n \rangle^{[d+s]}, \end{aligned}$$

where u and v have exact filtrations d and h . These elements are clearly $K(n)_*$ -linearly independent, so by Equation (3.3) and Proposition 1.3 they are $\mathcal{E}(n)_*$ -linearly independent. Thus they form a basis, so the exact sequence

$$0 \rightarrow M(u; s)_* \xrightarrow{v^{-1}V} M(uv; s)_* \rightarrow M(uv; s)_*/v^{-1}VM(u; s)_* \rightarrow 0$$

splits and there is a direct sum decomposition

$$M(uv; s)_* = v^{-1}VM(u; s)_* \oplus M(uv; s)_*/v^{-1}VM(u; s)_*.$$

□

The $\mathcal{E}(n)_*$ -linear maps $v^{-1}V$ and inc commute and together form a doubly directed system. Then we have

$$\begin{aligned} \mathcal{E}(n)_*\mathcal{E}(n) &= \varinjlim_{(u,s)} M(u; s)_* \\ &= \varinjlim_u \varinjlim_s M(u; s)_* \\ &= \varinjlim_s \varinjlim_u M(u; s)_*. \end{aligned}$$

Each $M(u; s)_*$ is a finitely generated free $\mathcal{E}(n)_*$ -module, with a basis consisting of the $\bar{\kappa}$ elements it contains; we will refer to this as its $\bar{\kappa}$ -basis. $M(u; s)_*$ also has another useful basis which we will now define.

Choose a cofinal sequence u_k in Λ , for example by the process described in Remark 3.1. For convenience we will assume that $u_0 = 1$. Of course

$$\begin{aligned} \mathcal{E}(n)_*\mathcal{E}(n) &= \varinjlim_{(r,s)} M(u_r; s)_* \\ &= \varinjlim_r \varinjlim_s M(u_r; s)_* \\ &= \varinjlim_s \varinjlim_r M(u_r; s)_*. \end{aligned}$$

When $r = 0$, we take the $\bar{\kappa}$ -basis for $M(1; s)_*$, denoting its elements by $\bar{\kappa}_{r_1, \dots, r_k}^{1;s}$. Now for $r \geq 1$, suppose that we have defined a basis $\bar{\kappa}_{r_1, \dots, r_k}^{u_{r-1};s}$ for $M(u_{r-1}; s)_*$.

For $M(u_r; s)_*$, replace each $\bar{\kappa}_{r_1, \dots, r_k}^{r-1; s}$ of this basis by

$$(4.1) \quad \begin{aligned} \bar{\kappa}_{r_1, \dots, r_k}^{u_r; s} &= w_r^{-1} W_r \bar{\kappa}_{r_1, \dots, r_k}^{u_{r-1}; s} \\ &\equiv \bar{\kappa}_{r_1, \dots, r_k}^{u_{r-1}; s} \pmod{I_n} \end{aligned}$$

whenever this element is also in $M(u_r; s)_*$. For $w_r^{-1} W_r \bar{\kappa}_{r_1, \dots, r_k}^{u_{r-1}; s} \notin M(u_r; s)_*$, set

$$(4.2) \quad \bar{\kappa}_{r_1, \dots, r_k}^{u_r; s} = \bar{\kappa}_{r_1, \dots, r_k}^{u_{r-1}; s}.$$

Notice that by repeated applications of Equation (3.3), we have for all basis elements,

$$(4.3) \quad \bar{\kappa}_{r_1, \dots, r_k}^{u_r; s} \equiv \bar{\kappa}_{r_1, \dots, r_k} \pmod{I_n}.$$

Next we consider the effect of raising s by considering the extension

$$M(u_r; s)_* \subseteq M(u_r; s+1)_*.$$

Clearly $M(u_r; s+1)_*$ contains all the elements $\bar{\kappa}_{r_1, \dots, r_k}^{u_r; s}$ together with its $\bar{\kappa}$ -basis elements of exact filtration $d_r + s + 1$ where d_r is the exact filtration of u_r . Reducing modulo I_n these elements are $K(n)_*$ -linearly independent, so by Equation (4.3) and Proposition 1.3 these are $\mathcal{E}(n)_*$ -linearly independent and hence form a basis, showing that this extension splits. We have demonstrated the following.

PROPOSITION 4.2. *For $r, s \geq 0$, the $\mathcal{E}(n)_*$ -module $M(u_r; s)_*$ is free with the following two bases:*

- $\mathcal{B}_1^{u_r; s}$ consisting of the elements $\bar{\kappa}_{r_1, \dots, r_k}$ contained in $M(u_r; s)_*$;
- $\mathcal{B}_2^{u_r; s}$ consisting of the elements $\bar{\kappa}_{r_1, \dots, r_k}^{u_r; s}$.

Now we can state our main result.

THEOREM 4.3. *$\mathcal{E}(n)_* \mathcal{E}(n)$ is $\mathcal{E}(n)_*$ -free with a basis consisting of the images of the non-zero elements of the form*

$$\bar{\kappa}_{r_1, \dots, r_k}^{u_r; s} \in M(u_r; s)_* - w_r^{-1} W_r M(u_{r-1}; s)_* \quad (r, s \geq 0)$$

under the natural map $M(u_r; s)_* \rightarrow \mathcal{E}(n)_* \mathcal{E}(n)$.

Proof. We begin by showing that these elements span $\mathcal{E}(n)_* \mathcal{E}(n)$. Let $z \in \mathcal{E}(n)_* \mathcal{E}(n)$ and suppose that t is the image of $z_r \in M(u_r; s)_*$ under the natural map

$$M(u_r; s)_* \rightarrow \mathcal{E}(n)_* \mathcal{E}(n).$$

Then z_r can be uniquely expressed as an $\mathcal{E}(n)_*$ -linear combination

$$z_r = \sum_{r_1, \dots, r_k} \lambda_{r_1, \dots, r_k} \bar{\kappa}_{r_1, \dots, r_k}^{u_r; s}.$$

We can split up this sum as

$$z_r = \left(\sum_{r_1, \dots, r_\ell} \lambda_{r_1, \dots, r_\ell} \bar{\kappa}_{r_1, \dots, r_\ell}^{u_{r-1}; s} \right) + w_r^{-1} W_r \left(\sum_{s_1, \dots, s_k} \lambda_{s_1, \dots, s_k} \bar{\kappa}_{s_1, \dots, s_k}^{u_{r-1}; s} \right).$$

Since

$$\sum_{r_1, \dots, r_\ell} \lambda_{r_1, \dots, r_\ell} \bar{\kappa}_{r_1, \dots, r_\ell}^{u_{r-1}; s} \in M(u_{r-1}; s)_*, \quad \sum_{s_1, \dots, s_k} \lambda_{s_1, \dots, s_k} \bar{\kappa}_{s_1, \dots, s_k}^{u_{r-1}; s} \in M(u_r; s)_*$$

map to linear combinations of the asserted basis elements in the images of $M(u_{r-1}; s)_*$ and $M(u_r; s)_*$ in $\mathcal{E}(n)_* \mathcal{E}(n)$, z is also a linear combination of those basis elements.

Now we show that these elements are linearly independent over $\mathcal{E}(n)_* \mathcal{E}(n)$. We know that $\mathcal{E}(n)_* \mathcal{E}(n)$ is $\mathcal{E}(n)_*$ -flat, and also that

$$K(n)_* \otimes_{\mathcal{E}(n)_*} \mathcal{E}(n)_* \mathcal{E}(n) = K(n)_* \mathcal{E}(n) \\ (= K(n)_* K(n) \text{ in the standard but misleading notation})$$

which has a $K(n)_*$ -basis consisting of the reductions of the elements

$$t_1^{r_1} \cdots t_k^{r_k} \quad (0 \leq r_j \leq p^n - 1).$$

Now $t_1^{r_1} \cdots t_k^{r_k}$ is the image of $\bar{\kappa}_{r_1, \dots, r_k}^{u_r; s} \in M(u_r; s)$ under the natural map. Careful book keeping shows that the asserted basis elements do indeed account for all the t_j -monomials in this basis of $K(n)_* \mathcal{E}(n)$. These are linearly independent in $\mathcal{E}(n)_* \mathcal{E}(n)$ by Proposition 1.3. \square

The following useful consequence of our construction is immediate on taking

$$\mathcal{E}(n)_* BP \langle n \rangle = \varinjlim_s M(1; s)_*.$$

COROLLARY 4.4. *The natural map*

$$\mathcal{E}(n)_* BP \langle n \rangle \longrightarrow \mathcal{E}(n)_* \mathcal{E}(n)$$

is a split monomorphism of $\mathcal{E}(n)_$ -modules.*

REFERENCES

- [1] J. F. Adams, *Stable Homotopy and Generalised Homology*, University of Chicago Press (1974).
- [2] J. F. Adams, *Infinite Loop Spaces*, Princeton University Press (1978).
- [3] J. F. Adams & F. W. Clarke, *Stable operations on complex K-theory*, Ill. J. Math. 21 (1977), 826–829.
- [4] A. Baker, *A version of the Landweber filtration theorem for v_n -periodic Hopf algebroids*, Osaka J. Math. 32 (1995), 689–99.
- [5] A. Baker, F. Clarke, N. Ray & L. Schwartz, *On the Kummer congruences and the stable homotopy of BU*, Trans. Amer. Math. Soc. 316 (1989), 385–432.
- [6] F. W. Clarke, *Operations in K-theory and p-adic analysis*, in the proceedings of the Groupe d'étude d'Analyse Ultramétrique, 14^{me} année: 1986/87, Paris; corrected version available at <http://www-maths.swan.ac.uk/staff/fwc/research.html>.

- [7] A. Elmendorf, I. Kriz, M. Mandell & J. P. May, Rings, modules, and algebras in stable homotopy theory, *Mathematical Surveys and Monographs*, 47 (1996).
- [8] M. J. Hopkins & D. C. Ravenel, The Hopf algebroid $E(n)_*E(n)$, preprint (1989).
- [9] M. Hovey & H. Sadofsky, Invertible spectra in the $E(n)$ -local stable homotopy category, to appear in *Jour. Lond. Math. Soc.*
- [10] M. Hovey & N. P. Strickland, Morava K -theory and localisation, *Mem. Amer. Math Soc.* 139 (1999), no. 666.
- [11] P. S. Landweber, Homological properties of comodules over MU_*MU and BP_*BP , *Amer. J. Math.*, 98 (1976), 591–610.
- [12] H. Matsumura, *Commutative Ring Theory*, Cambridge University Press (1986).
- [13] H. R. Miller & D. C. Ravenel, Morava stabilizer algebras and localization of Novikov's E_2 -term, *Duke Math. J.*, 44 (1977), 433–47.
- [14] D. C. Ravenel, *Complex Cobordism and the Stable Homotopy Groups of Spheres*, Academic Press (1986).
- [15] N. P. Strickland, Products on MU -modules, *Trans. Amer. Math. Soc.* 351 (1999), 2569–2606.

Andrew Baker
Department of Mathematics,
University of Glasgow,
Glasgow G12 8QW,
Scotland.
a.baker@maths.gla.ac.uk
www.maths.gla.ac.uk/~ajb

HEEGNER POINTS AND L -SERIES OF AUTOMORPHIC
CUSP FORMS OF DRINFELD TYPE

HANS-GEORG RÜCK AND ULRICH TIPP

Received: April 27, 2000

Communicated by Peter Schneider

ABSTRACT. In their famous article [Gr-Za], Gross and Zagier proved a formula relating heights of Heegner points on modular curves and derivatives of L -series of cusp forms.

We prove the function field analogue of this formula. The classical modular curves parametrizing isogenies of elliptic curves are now replaced by Drinfeld modular curves dealing with isogenies of Drinfeld modules. Cusp forms on the classical upper half plane are replaced by harmonic functions on the edges of a Bruhat-Tits tree.

As a corollary we prove the conjecture of Birch and Swinnerton-Dyer for certain elliptic curves over function fields whose analytic rank is equal to 1.

2000 Mathematics Subject Classification: 11G40 11G50 11F67 11G09

Keywords and Phrases: Heegner points, Drinfeld modular curves, L -series, automorphic cusp forms, Gross-Zagier formula

1 INTRODUCTION

Let $K = \mathbb{F}_q(T)$ be the rational function field over a finite field \mathbb{F}_q of odd characteristic. In K we distinguish the polynomial ring $\mathbb{F}_q[T]$ and the place ∞ . We consider harmonic functions f on $GL_2(K_\infty)/\Gamma_\infty K_\infty^*$, the edges of the Bruhat-Tits tree of GL_2 , which are invariant under $\Gamma_0(N)$ for $N \in \mathbb{F}_q[T]$. These are called automorphic cusp forms of Drinfeld type of level N (cf. section 2.1).

Let $L = K(\sqrt{D})$, with $\gcd(N, D) = 1$, be an imaginary quadratic extension of K (we assume that D is irreducible to make calculations technically easier). We attach to an automorphic cusp form f of Drinfeld type of level N , which is a newform, and to an element \mathcal{A} in the class group of $O_L = \mathbb{F}_q[T][\sqrt{D}]$ an L -series $L(f, \mathcal{A}, s)$ (section 2.1).

We represent this L -series (normalized by a suitable factor $L^{(N,D)}(2s+1)$) as a Petersson product of f and a function Φ_s on $\Gamma_0(N) \backslash GL_2(K_\infty)/\Gamma_\infty K_\infty^*$ (sections 2.2 and 2.3). From this representation we get a functional equation for $L(f, \mathcal{A}, s)$ (Theorem 2.7.3 and Theorem 2.7.6), which shows in particular that $L(f, \mathcal{A}, s)$ has a zero at $s=0$, if $\left[\frac{D}{N}\right] = 1$.

In this case, under the additional assumptions that N is square free and that each of its prime divisors is split in L , we evaluate the derivative of $L(f, \mathcal{A}, s)$ at $s=0$. Since the function Φ_s is not harmonic in general, we apply a holomorphic projection formula (cf. section 2.4) to get

$$\frac{\partial}{\partial s} (L^{(N,D)}(2s+1)L(f, \mathcal{A}, s))|_{s=0} = \int f \cdot \overline{\Psi_{\mathcal{A}}} \quad (\text{if } \deg D \text{ is odd}),$$

resp.

$$\frac{\partial}{\partial s} \left(\frac{1}{1+q^{-s-1}} L^{(N,D)}(2s+1)L(f, \mathcal{A}, s) \right) |_{s=0} = \int f \cdot \overline{\Psi_{\mathcal{A}}} \quad (\text{if } \deg D \text{ is even}),$$

where $\Psi_{\mathcal{A}}$ is an automorphic cusp form of Drinfeld type of level N . The Fourier coefficients $\Psi_{\mathcal{A}}^*(\pi_\infty^{\deg \lambda+2}, \lambda)$ of $\Psi_{\mathcal{A}}$ are evaluated in sections 2.5, 2.6 and 2.8. The results are summarized in Theorem 2.8.2 and Theorem 2.8.3.

On the other hand let x be a Heegner point on the Drinfeld modular curve $X_0(N)$ with complex multiplication by $O_L = \mathbb{F}_q[T][\sqrt{D}]$. There exists a cusp form $g_{\mathcal{A}}$ of Drinfeld type of level N whose Fourier coefficients are given by (cf. Proposition 3.1.1):

$$g_{\mathcal{A}}^*(\pi_\infty^{\deg \lambda+2}, \lambda) = q^{-\deg \lambda} \langle (x) - (\infty), T_\lambda((x)^{\sigma_{\mathcal{A}}} - (0)) \rangle,$$

where the automorphism $\sigma_{\mathcal{A}}$ belongs to the class \mathcal{A} via class field theory, where T_λ is the Hecke operator attached to λ and where $\langle \cdot, \cdot \rangle$ denotes the global Néron-Tate height pairing of divisors on $X_0(N)$ over the Hilbert class field of L .

We want to compare the cusp forms $\Psi_{\mathcal{A}}$ and $g_{\mathcal{A}}$. Therefore we have to evaluate the height of Heegner points, which is the content of chapter 3. We evaluate the heights locally at each place of K . At the places belonging to the polynomial ring $\mathbb{F}_q[T]$ we use the modular interpretation of Heegner points by Drinfeld modules. Counting homomorphisms between different Drinfeld modules (similar to calculations in [Gr-Za]) yields the formula for these local heights (Corollary 3.4.10 and Proposition 3.4.13). At the place ∞ we construct a Green's function on the analytic upper half plane, which gives the local height in this case (Propositions 3.6.3, 3.6.5). Finally we evaluate the Fourier coefficients of $g_{\mathcal{A}}$ in Theorems 3.6.4 and 3.6.6.

In chapter 4 we compare the results on the derivatives of the L -series, i.e. the Fourier coefficients $\Psi_{\mathcal{A}}^*(\pi_\infty^{\deg \lambda+2}, \lambda)$, and the result on the heights of Heegner points, i.e. the coefficients $g_{\mathcal{A}}^*(\pi_\infty^{\deg \lambda+2}, \lambda)$, and get our main result (cf. Theorem 4.1.1 and Theorem 4.1.2): If $\gcd(\lambda, N) = 1$, then

$$\Psi_{\mathcal{A}}^*(\pi_\infty^{\deg \lambda+2}, \lambda) = \frac{q-1}{2} q^{-(\deg D+1)/2} g_{\mathcal{A}}^*(\pi_\infty^{\deg \lambda+2}, \lambda) \quad (\text{if } \deg D \text{ is odd}),$$

resp.

$$\Psi_{\mathcal{A}}^*(\pi_{\infty}^{\deg \lambda+2}, \lambda) = \frac{q-1}{4} q^{-\deg D/2} g_{\mathcal{A}}^*(\pi_{\infty}^{\deg \lambda+2}, \lambda) \text{ (if } \deg D \text{ is even).}$$

We apply this result to elliptic curves. Let E be an elliptic curve over K with conductor $N \cdot \infty$, which has split multiplicative reduction at ∞ , then E is modular, i.e. it belongs to an automorphic cusp form f of Drinfeld type of level N . In particular the L -series of E/K and of f satisfy $L(E, s+1) = L(f, s)$. The L -series of E over the field $L = K(\sqrt{D})$ equals $L(E, s)L(E_D, s)$ and can be computed by

$$L(E, s+1)L(E_D, s+1) = \sum_{\mathcal{A} \in Cl(O_L)} L^{(N,D)}(2s+1)L(f, \mathcal{A}, s),$$

if $\deg D$ is odd, or in the even case by

$$L(E, s+1)L(E_D, s+1) = \sum_{\mathcal{A} \in Cl(O_L)} \frac{1}{1+q^{-s-1}} L^{(N,D)}(2s+1)L(f, \mathcal{A}, s).$$

This motivates the consideration of the L -series $L(f, \mathcal{A}, s)$.

The functional equations for all $L(f, \mathcal{A}, s)$ yield that $L(E, s)L(E_D, s)$ has a zero at $s = 1$. In order to evaluate the first derivative, we consider a uniformization $\pi : X_0(N) \rightarrow E$ of the modular elliptic curve E and the Heegner point $P_L := \sum_{\mathcal{A} \in Cl(O_L)} \pi(x^{\sigma_{\mathcal{A}}})$. P_L is an L -rational point on E .

Our main result yields a formula relating the derivative of the L -series of E/L and the Néron-Tate height $\hat{h}_{E,L}(P_L)$ of the Heegner point on E over L (Theorem 4.2.1):

$$\frac{\partial}{\partial s}(L(E, s)L(E_D, s)) \Big|_{s=1} = \hat{h}_{E,L}(P_L) c(D) (\deg \pi)^{-1} \int_{\Gamma_0(N) \backslash GL_2(K_{\infty}) / \Gamma_{\infty} K_{\infty}^*} f \cdot \bar{f},$$

where the constant $c(D)$ equals $\frac{q-1}{2} q^{-(\deg D+1)/2}$ (if $\deg D$ is odd) or $\frac{q-1}{4} q^{-\deg D/2}$ (if $\deg D$ is even).

As a corollary (Corollary 4.2.2) we prove the conjecture of Birch and Swinnerton-Dyer for E/L , if its analytic rank is equal to 1.

Large parts of this work were supported by the DFG-Schwerpunkt ‘‘Algorithmische Algebra und Zahlentheorie’’. We are very thankful for this.

2 L -SERIES

2.1 BASIC DEFINITIONS OF L -SERIES

Let \mathbb{F}_q be the finite field with $q = p^\alpha$ elements ($p \neq 2$), and let $K = \mathbb{F}_q(T)$ be the rational function field over \mathbb{F}_q . We distinguish the finite places given by the irreducible elements in the polynomial ring $\mathbb{F}_q[T]$ and the place ∞ of K . For ∞

we consider the completion K_∞ with normalized valuation v_∞ and valuation ring O_∞ . We fix the prime $\pi_\infty = T^{-1}$, then $K_\infty = \mathbb{F}_q((\pi_\infty))$. In addition we define the following additive character ψ_∞ of K_∞ : Take $\sigma : \mathbb{F}_q \rightarrow \mathbb{C}^*$ with $\sigma(a) = \exp(\frac{2\pi i}{p} \text{Tr}_{\mathbb{F}_q/\mathbb{F}_p}(a))$ and set $\psi_\infty(\sum a_i \pi_\infty^i) = \sigma(-a_1)$. The oriented edges of the Bruhat-Tits tree of GL_2 over K_∞ are parametrized by the set $GL_2(K_\infty)/\Gamma_\infty K_\infty^*$, where

$$\Gamma_\infty := \left\{ \begin{pmatrix} \alpha & \beta \\ \gamma & \delta \end{pmatrix} \in GL_2(O_\infty) \mid v_\infty(\gamma) > 0 \right\}.$$

$GL_2(K_\infty)/\Gamma_\infty K_\infty^*$ can be represented by the two disjoint sets

$$\mathcal{T}_+ := \left\{ \begin{pmatrix} \pi_\infty^m & u \\ 0 & 1 \end{pmatrix} \mid m \in \mathbb{Z}, u \in K_\infty/\pi_\infty^m O_\infty \right\} \quad (2.1.1)$$

and

$$\mathcal{T}_- := \left\{ \begin{pmatrix} \pi_\infty^m & u \\ 0 & 1 \end{pmatrix} \begin{pmatrix} 0 & 1 \\ \pi_\infty & 0 \end{pmatrix} \mid m \in \mathbb{Z}, u \in K_\infty/\pi_\infty^m O_\infty \right\}. \quad (2.1.2)$$

Right multiplication by $\begin{pmatrix} 0 & 1 \\ \pi_\infty & 0 \end{pmatrix}$ reverses the orientation of an edge.

We do not distinguish between matrices in $GL_2(K_\infty)$ and the corresponding classes in $GL_2(K_\infty)/\Gamma_\infty K_\infty^*$.

We want to study functions on $GL_2(K_\infty)/\Gamma_\infty K_\infty^*$. Special functions are defined in the following way: The groups $GL_2(\mathbb{F}_q[T])$ and $SL_2(\mathbb{F}_q[T])$ operate on $GL_2(K_\infty)/\Gamma_\infty K_\infty^*$ by left multiplication. For $N \in \mathbb{F}_q[T]$ let

$$\Gamma_0(N) := \left\{ \begin{pmatrix} a & b \\ c & d \end{pmatrix} \in GL_2(\mathbb{F}_q[T]) \mid c \equiv 0 \pmod{N} \right\}$$

and $\Gamma_0^{(1)}(N) := \Gamma_0(N) \cap SL_2(\mathbb{F}_q[T])$.

DEFINITION 2.1.1 *A function $f : GL_2(K_\infty)/\Gamma_\infty K_\infty^* \rightarrow \mathbb{C}$ is called an automorphic cusp form of Drinfeld type of level N if it satisfies the following conditions:*

i) f is harmonic, i.e.,

$$f\left(X \begin{pmatrix} 0 & 1 \\ \pi_\infty & 0 \end{pmatrix}\right) = -f(X)$$

and

$$\sum_{\beta \in GL_2(O_\infty)/\Gamma_\infty} f(X\beta) = 0$$

for all $X \in GL_2(K_\infty)/\Gamma_\infty K_\infty^$,*

ii) f is invariant under $\Gamma_0(N)$, i.e.,

$$f(AX) = f(X)$$

for all $X \in GL_2(K_\infty)/\Gamma_\infty K_\infty^*$ and $A \in \Gamma_0(N)$,
 iii) f has compact support modulo $\Gamma_0(N)$, i.e. there are only finitely many elements \bar{X} in $\Gamma_0(N)\backslash GL_2(K_\infty)/\Gamma_\infty K_\infty^*$ with $f(\bar{X}) \neq 0$.

Any function f on $GL_2(K_\infty)/\Gamma_\infty K_\infty^*$ which is invariant under $\begin{pmatrix} 1 & \mathbb{F}_q[T] \\ 0 & 1 \end{pmatrix}$ has a Fourier expansion

$$f\left(\begin{pmatrix} \pi_\infty^m & u \\ 0 & 1 \end{pmatrix}\right) = \sum_{\lambda \in \mathbb{F}_q[T]} f^*(\pi_\infty^m, \lambda) \psi_\infty(\lambda u) \tag{2.1.3}$$

with

$$f^*(\pi_\infty^m, \lambda) = \int_{K_\infty/\mathbb{F}_q[T]} f\left(\begin{pmatrix} \pi_\infty^m & u \\ 0 & 1 \end{pmatrix}\right) \psi_\infty(-\lambda u) du,$$

where du is a Haar measure with $\int_{K_\infty/\mathbb{F}_q[T]} du = 1$.

Since $\begin{pmatrix} 1 & \mathbb{F}_q[T] \\ 0 & 1 \end{pmatrix} \subset \Gamma_0(N)$ this applies to automorphic cusp forms. In this particular case the harmonicity conditions of Definition 2.1.1 imply

$$\begin{aligned} f^*(\pi_\infty^m, \lambda) &= 0, \text{ if } \lambda = 0 \text{ or if } \deg \lambda + 2 > m, \\ f^*(\pi_\infty^m, \lambda) &= q^{-m+\deg \lambda+2} f^*(\pi_\infty^{\deg \lambda+2}, \lambda), \text{ if } \lambda \neq 0 \text{ and } \deg \lambda + 2 \leq m. \end{aligned} \tag{2.1.4}$$

Hence we get the following:

REMARK 2.1.2 *All the Fourier coefficients of an automorphic cusp form f of Drinfeld type are uniquely determined by the coefficients $f^*(\pi_\infty^{\deg \lambda+2}, \lambda)$ for $\lambda \in \mathbb{F}_q[T]$.*

To an automorphic cusp form f one can attach an L -series $L(f, s)$ in the following way (cf. [We1], [We2]): Let \mathfrak{m} be an effective divisor of K of degree n , then $\mathfrak{m} = (\lambda)_0 + (n - \deg \lambda)_\infty$ with $\lambda \in \mathbb{F}_q[T]$, $\deg \lambda \leq n$. We define

$$f^*(\mathfrak{m}) = f^*(\pi_\infty^{n+2}, \lambda) \quad \text{and} \quad L(f, s) = \sum_{\mathfrak{m} \geq 0} f^*(\mathfrak{m}) N(\mathfrak{m})^{-s}, \tag{2.1.5}$$

where $N(\mathfrak{m})$ denotes the absolute norm of the divisor \mathfrak{m} .

The \mathbb{C} -vector space of automorphic cusp forms of Drinfeld type of level N is finite dimensional and it is equipped with a non-degenerate pairing, the Petersson product, given by

$$(f, g) \mapsto \int_{\Gamma_0(N)\backslash GL_2(K_\infty)/\Gamma_\infty K_\infty^*} f \cdot \bar{g}.$$

There is the notion of oldforms, i.e. linear combinations of forms $g\left(\begin{pmatrix} d & 0 \\ 0 & 1 \end{pmatrix} X\right)$, where g is an automorphic cusp form of level M , $M|N$

and $M \neq N$, and d is a divisor of N/M . Automorphic cusp forms of Drinfeld type which are perpendicular under the Petersson product to all the oldforms are called newforms.

Important examples of newforms are the following: Let E be an elliptic curve over K with conductor $N \cdot \infty$, which has split multiplicative reduction at ∞ , then E belongs to a newform f of level N such that the L -series of E satisfies ([De])

$$L(E, s + 1) = L(f, s). \quad (2.1.6)$$

This newform is in addition an eigenform for all Hecke operators, but we do not assume this property in general.

From now on let f be an automorphic cusp form of level N which is a newform. Let L/K be an imaginary quadratic extension (i.e. a quadratic extension of K where ∞ is not split) in which each (finite) divisor of N is not ramified. Then there is a square free polynomial $D \in \mathbb{F}_q[T]$, prime to N with $L = K(\sqrt{D})$.

We assume in this paper that D is an irreducible polynomial. In principle all the arguments apply to the general case, but the details are technically more complicated. We distinguish two cases. In the first case the degree of D is odd, i.e. ∞ is ramified in L/K ; in the second case the degree of D is even and its leading coefficient is not a square in \mathbb{F}_q^* , i.e. ∞ is inert in L/K .

The integral closure of $\mathbb{F}_q[T]$ in L is $O_L = \mathbb{F}_q[T][\sqrt{D}]$.

Let \mathcal{A} be an element of the class group $Cl(O_L)$ of O_L . For an effective divisor $\mathfrak{m} = (\lambda)_0 + (n - \deg \lambda)\infty$ (as above) we define

$$r_{\mathcal{A}}(\mathfrak{m}) = \#\{\mathfrak{a} \in \mathcal{A} \mid \mathfrak{a} \text{ integral with } N_{L/K}(\mathfrak{a}) = \lambda \mathbb{F}_q[T]\} \quad (2.1.7)$$

and hence we get the partial zeta function attached to \mathcal{A} as

$$\zeta_{\mathcal{A}}(s) = \sum_{\mathfrak{m} \geq 0} r_{\mathcal{A}}(\mathfrak{m}) N(\mathfrak{m})^{-s}. \quad (2.1.8)$$

For the calculations it is sometimes easier to define a function depending on elements of $\mathbb{F}_q[T]$ instead of divisors. We choose $\mathfrak{a}_0 \in \mathcal{A}^{-1}$ and $\lambda_0 \in K$ with $N_{L/K}(\mathfrak{a}_0) = \lambda_0 \mathbb{F}_q[T]$ and define

$$r_{\mathfrak{a}_0, \lambda_0}(\lambda) = \#\{\mu \in \mathfrak{a}_0 \mid N_{L/K}(\mu) = \lambda_0 \lambda\}. \quad (2.1.9)$$

Then

$$r_{\mathcal{A}}(\mathfrak{m}) = \frac{1}{q-1} \sum_{\epsilon \in \mathbb{F}_q^*} r_{\mathfrak{a}_0, \lambda_0}(\epsilon \lambda).$$

The theta series is defined as

$$\Theta_{\mathfrak{a}_0, \lambda_0} \left(\begin{pmatrix} \pi_{\infty}^m & u \\ 0 & 1 \end{pmatrix} \right) = \sum_{\deg \lambda + 2 \leq m} r_{\mathfrak{a}_0, \lambda_0}(\lambda) \psi_{\infty}(\lambda u). \quad (2.1.10)$$

We will see later that the transformation rules of this theta series are the starting point of all our calculations.

Now we combine the L -series of a newform f (cf. (2.1.5)) and the partial zeta function of \mathcal{A} (cf. (2.1.8)) to obtain the function

$$L(f, \mathcal{A}, s) = \sum_{\mathfrak{m} \geq 0} f^*(\mathfrak{m})r_{\mathcal{A}}(\mathfrak{m})N(\mathfrak{m})^{-s}. \tag{2.1.11}$$

For technical reasons we introduce

$$L^{(N,D)}(2s+1) = \frac{1}{q-1} \sum_{\substack{k \in \mathbb{F}_q[T] \\ \gcd(k,N)=1}} \left[\frac{D}{k} \right] q^{-(2s+1) \deg k}, \tag{2.1.12}$$

where $\left[\frac{D}{k} \right]$ denotes the Legendre resp. the Jacobi symbol for the polynomial ring $\mathbb{F}_q[T]$. For an irreducible $k \in \mathbb{F}_q[T]$ and a coprime $D \in \mathbb{F}_q[T]$ the Legendre symbol $\left[\frac{D}{k} \right]$ is by definition equal to 1 or -1 if D is or is not a square in $(\mathbb{F}_q[T]/k\mathbb{F}_q[T])^*$, respectively. If D is divisible by k , then $\left[\frac{D}{k} \right]$ equals 0. This definition is multiplicatively extended to the Jacobi symbol for arbitrary, not necessarily irreducible k , so e.g. $\left[\frac{D}{k} \right] = \left[\frac{D}{k_1} \right] \cdot \left[\frac{D}{k_2} \right]$ if $k = k_1 \cdot k_2$.

In the first case, where $\deg D$ is odd, the function

$$L^{(N,D)}(2s+1)L(f, \mathcal{A}, s)$$

is the focus of our interest; in the case of even degree it is the function

$$\frac{1}{1+q^{-s-1}}L^{(N,D)}(2s+1)L(f, \mathcal{A}, s).$$

This is motivated by the following fact:

PROPOSITION 2.1.3 *Let E be an elliptic curve with conductor $N \cdot \infty$ and corresponding newform f as above and let E_D be its twist by D . Then the following identities hold:*

$$L(E, s+1)L(E_D, s+1) = \sum_{\mathcal{A} \in Cl(O_L)} L^{(N,D)}(2s+1)L(f, \mathcal{A}, s)$$

if $\deg D$ is odd, and

$$L(E, s+1)L(E_D, s+1) = \sum_{\mathcal{A} \in Cl(O_L)} \frac{1}{1+q^{-s-1}}L^{(N,D)}(2s+1)L(f, \mathcal{A}, s)$$

if $\deg D$ is even.

It is not difficult to prove this fact using the definitions of the coefficients $f^*(\mathfrak{m})$ (cf. (2.1.5)) and $r_{\mathcal{A}}(\mathfrak{m})$ (cf. (2.1.7)) and the Euler products of the L -series of the elliptic curves.

2.2 RANKIN'S METHOD

The properties of the automorphic cusp form f yield

$$f^*(\pi_\infty^m, \lambda) = q^{-m+1} \sum_{u \in \pi_\infty / \pi_\infty^m} f\left(\begin{pmatrix} \pi_\infty^m & u \\ 0 & 1 \end{pmatrix}\right) \psi_\infty(-\lambda u). \quad (2.2.1)$$

We use this to calculate

$$L(f, \mathcal{A}, s) = \frac{1}{q-1} \sum_{m=2}^{\infty} \left(\sum_{\deg \lambda + 2 \leq m} f^*(\pi_\infty^m, \lambda) r_{\mathfrak{a}_0, \lambda_0}(\lambda) \right) q^{-(m-2)s}. \quad (2.2.2)$$

Now we distinguish the two cases.

2.2.1 $\deg D$ IS ODD

We continue with equations (2.2.1) and (2.2.2):

$$\begin{aligned} L(f, \mathcal{A}, s) &= \frac{q}{q-1} \sum_{m=2}^{\infty} \sum_{u \in \pi_\infty / \pi_\infty^m} f\left(\begin{pmatrix} \pi_\infty^m & u \\ 0 & 1 \end{pmatrix}\right) \overline{\Theta_{\mathfrak{a}_0, \lambda_0}\left(\begin{pmatrix} \pi_\infty^m & u \\ 0 & 1 \end{pmatrix}\right)} q^{-m(s+1)+2s} \\ &= \frac{q}{q-1} \int_{\mathbb{H}_\infty} f\left(\begin{pmatrix} \pi_\infty^m & u \\ 0 & 1 \end{pmatrix}\right) \overline{\Theta_{\mathfrak{a}_0, \lambda_0}\left(\begin{pmatrix} \pi_\infty^m & u \\ 0 & 1 \end{pmatrix}\right)} q^{-m(\bar{s}+1)+2\bar{s}}, \end{aligned} \quad (2.2.3)$$

where

$$\mathbb{H}_\infty := \left(\begin{array}{cc} 1 & \mathbb{F}_q[T] \\ 0 & 1 \end{array} \right) \backslash \left(\begin{array}{cc} K_\infty^* & K_\infty \\ 0 & 1 \end{array} \right) / \left(\begin{array}{cc} O_\infty^* & O_\infty \\ 0 & 1 \end{array} \right).$$

We consider the canonical mapping

$$\mathbb{H}_\infty \rightarrow \Gamma_0^{(1)}(ND) \backslash GL_2(K_\infty) / \Gamma_\infty K_\infty^* =: G(ND),$$

which is surjective. We take the measure on $G(ND)$ which counts the size of the stabilizer of an element (cf. [Ge-Re], (4.8)). Then we get

$$\begin{aligned} L(f, \mathcal{A}, s) &= \frac{q}{2(q-1)} \\ &\cdot \int_{G(ND)} f\left(\begin{pmatrix} \pi_\infty^m & u \\ 0 & 1 \end{pmatrix}\right) \sum_M \overline{\Theta_{\mathfrak{a}_0, \lambda_0}\left(M \begin{pmatrix} \pi_\infty^m & u \\ 0 & 1 \end{pmatrix}\right)} q^{-m^*(\bar{s}+1)+2\bar{s}} \end{aligned} \quad (2.2.4)$$

where the sum is taken over those $M = \begin{pmatrix} a & b \\ c & d \end{pmatrix} \in \left(\begin{array}{cc} 1 & \mathbb{F}_q[T] \\ 0 & 1 \end{array} \right) \backslash \Gamma_0^{(1)}(ND)$

with $M \begin{pmatrix} \pi_\infty^m & u \\ 0 & 1 \end{pmatrix} \in \mathcal{T}_+$, and where $m^* = m - 2v_\infty(cu + d)$.

REMARK 2.2.1 *The definitions of \mathcal{T}_+ and \mathcal{T}_- (cf. (2.1.1), (2.1.2)) yield:*

$$M \begin{pmatrix} \pi_\infty^m & u \\ 0 & 1 \end{pmatrix} \in \mathcal{T}_+ \text{ if and only if } v_\infty(c\pi_\infty^m) > v_\infty(cu + d).$$

In ([Rül], Theorem 6.2) we showed that for those M satisfying $v_\infty(c\pi_\infty^m) > v_\infty(cu + d)$ one has the following transformation rule for the theta series (cf. (2.1.10)):

$$\Theta_{\mathfrak{a}_0, \lambda_0} \left(M \begin{pmatrix} \pi_\infty^m & u \\ 0 & 1 \end{pmatrix} \right) = \Theta_{\mathfrak{a}_0, \lambda_0} \left(\begin{pmatrix} \pi_\infty^m & u \\ 0 & 1 \end{pmatrix} \right) \left[\frac{d}{D} \right] \delta_{cu+d} q^{-v_\infty(cu+d)}, \tag{2.2.5}$$

where $\left[\frac{d}{D} \right]$ is the Legendre symbol (defined in section 2.1) and where δ_z denotes the local norm symbol at ∞ , i.e., δ_z is equal to 1 if $z \in K_\infty^*$ is the norm of an element in the quadratic extension $K_\infty(\sqrt{D})/K_\infty$ and -1 otherwise.

Equations (2.2.4), (2.2.5) and the definition of $L^{(N,D)}$ (cf. (2.1.12)) yield:

$$L^{(N,D)}(2s+1)L(f, \mathcal{A}, s) = \frac{q}{2(q-1)} \int_{G(ND)} f \cdot \overline{\Theta_{\mathfrak{a}_0, \lambda_0} H_{1, \bar{s}}}$$

with

$$H_{1,s} \left(\begin{pmatrix} \pi_\infty^m & u \\ 0 & 1 \end{pmatrix} \right) := q^{-m(s+1)+2s} \sum_{\substack{c,d \in \mathbb{F}_q[T] \\ c \equiv 0 \pmod{ND} \\ \gcd(d,N)=1 \\ v_\infty(c\pi_\infty^m) > v_\infty(cu+d)}} \left[\frac{d}{D} \right] \delta_{cu+d} q^{v_\infty(cu+d)(2s+1)}.$$

We see that $\Theta_{\mathfrak{a}_0, \lambda_0} H_{1,s}$ is a function on $G(ND)$.

Let $\mu : \mathbb{F}_q[T] \rightarrow \{0, 1, -1\}$ be the Moebius function with

$$\sum_{\substack{e \in \mathbb{F}_q[T] \\ e|n}} \mu(e) = 0 \text{ if } n \mathbb{F}_q[T] \neq \mathbb{F}_q[T],$$

and

$$\frac{1}{q-1} \sum_{e \in \mathbb{F}_q^*} \mu(e) = 1,$$

then $H_{1,s} \left(\begin{pmatrix} \pi_\infty^m & u \\ 0 & 1 \end{pmatrix} \right)$

$$= \frac{q^{-m(s+1)+2s}}{q-1} \sum_{e|N} \mu(e) \left[\frac{e}{D} \right] \delta_e q^{-(2s+1) \deg e} E_s^{(1)} \left(\begin{pmatrix} \frac{N\pi_\infty^m}{e} & \frac{Nu}{e} \\ 0 & 1 \end{pmatrix} \right)$$

with the Eisenstein series

$$E_s^{(1)}\left(\begin{pmatrix} \pi_\infty^m & u \\ 0 & 1 \end{pmatrix}\right) := \sum_{\substack{c,d \in \mathbb{F}_q[T] \\ c \equiv 0 \pmod{D} \\ v_\infty(c\pi_\infty^m) > v_\infty(cu+d)}} \left[\frac{d}{D}\right] \delta_{cu+d} q^{v_\infty(cu+d)(2s+1)}. \quad (2.2.6)$$

For a divisor e of N the function

$$\Theta_{\mathfrak{a}_0, \lambda_0} \left(\begin{pmatrix} \pi_\infty^m & u \\ 0 & 1 \end{pmatrix} \right) q^{-m(s+1)+2s} E_s^{(1)} \left(\begin{pmatrix} \frac{N\pi_\infty^m}{e} & \frac{Nu}{e} \\ 0 & 1 \end{pmatrix} \right)$$

on $GL_2(K_\infty)/\Gamma_\infty K_\infty^*$ is invariant under $\Gamma_0^{(1)}\left(\frac{ND}{e}\right)$.

Since we assume that f is a newform of level N , it is orthogonal (with respect to the Petersson product) to functions of lower level. Therefore we get

PROPOSITION 2.2.2 *Let $\deg D$ be odd, then*

$$L^{(N,D)}(2s+1)L(f, \mathcal{A}, s) = \frac{q}{2(q-1)} \int_{G(ND)} f \cdot \overline{\Theta_{\mathfrak{a}_0, \lambda_0} H_{2,s}}$$

with $H_{2,s}\left(\begin{pmatrix} \pi_\infty^m & u \\ 0 & 1 \end{pmatrix}\right)$

$$\begin{aligned} &:= q^{-m(s+1)+2s} E_s^{(1)} \left(\begin{pmatrix} N\pi_\infty^m & Nu \\ 0 & 1 \end{pmatrix} \right) \quad (2.2.7) \\ &= q^{-m(s+1)+2s} \sum_{\substack{c,d \in \mathbb{F}_q[T] \\ c \equiv 0 \pmod{D} \\ v_\infty(cN\pi_\infty^m) > v_\infty(cNu+d)}} \left[\frac{d}{D}\right] \delta_{cNu+d} q^{v_\infty(cNu+d)(2s+1)}. \end{aligned}$$

2.2.2 $\deg D$ IS EVEN

We use equation (2.2.2) and the geometric series expansion of $1/(1+q^{-s-1})$ to evaluate

$$\begin{aligned} &\frac{1}{1+q^{-s-1}} L(f, \mathcal{A}, s) = \frac{1}{q-1} \\ &\cdot \sum_{m=2}^\infty q^{-(m-2)s} \sum_{l=2}^m \left(\sum_{\deg \lambda+2 \leq l} f^*(\pi_\infty^l, \lambda) r_{\mathfrak{a}_0, \lambda_0}(\lambda) \right) (-q^{-1})^{m-l}. \end{aligned}$$

Since f is an automorphic cusp form and hence $f^*(\pi_\infty^l, \lambda) = q^{m-l} f^*(\pi_\infty^m, \lambda)$ (cf. (2.1.4)), we get

$$\begin{aligned} &\frac{1}{1+q^{-s-1}} L(f, \mathcal{A}, s) = \frac{1}{q-1} \\ &\cdot \sum_{m=2}^\infty \left(\sum_{\deg \lambda+2 \leq m} f^*(\pi_\infty^m, \lambda) r_{\mathfrak{a}_0, \lambda_0}(\lambda) \right) q^{-(m-2)s} \frac{(-1)^{m-\deg \lambda} + 1}{2}. \end{aligned}$$

If $r_{a_0, \lambda_0}(\lambda) \neq 0$, then $\deg \lambda \equiv \deg \lambda_0 \pmod 2$, because $\deg D$ is even. Now equation (2.2.1) yields

$$\frac{1}{1 + q^{-s-1}} L(f, \mathcal{A}, s) = \frac{q}{q-1} \cdot \int_{\mathbb{H}_\infty} f\left(\begin{pmatrix} \pi_\infty^m & u \\ 0 & 1 \end{pmatrix}\right) \overline{\Theta_{a_0, \lambda_0}\left(\begin{pmatrix} \pi_\infty^m & u \\ 0 & 1 \end{pmatrix}\right)} q^{-m(\bar{s}+1)+2\bar{s}} \frac{(-1)^{m-\deg \lambda_0} + 1}{2}.$$

Thus the right side of this equation differs from (2.2.3) only by the factor $((-1)^{m-\deg \lambda_0} + 1)/2$. But this factor is invariant under $GL_2(\mathbb{F}_q[T])$ and hence causes no problems here or in the next steps. Proceeding exactly as in the case where $\deg D$ is odd gives the following result:

PROPOSITION 2.2.3 *Let $\deg D$ be even, then*

$$\frac{1}{1 + q^{-s-1}} L^{(N,D)}(2s + 1) L(f, \mathcal{A}, s) = \frac{q}{2(q-1)} \cdot \int_{G(N,D)} f \cdot \overline{\Theta_{a_0, \lambda_0} H_{2, \bar{s}}} \frac{(-1)^{m-\deg \lambda_0} + 1}{2}$$

with $H_{2,s}$ given by equation (2.2.7).

2.3 COMPUTATION OF THE TRACE

The function $\Theta_{a_0, \lambda_0} H_{2,s}$ on $GL_2(K_\infty)/\Gamma_\infty K_\infty^*$ is only invariant under $\Gamma_0^{(1)}(ND)$. To make it invariant under $\Gamma_0^{(1)}(N)$ we compute the trace with respect to the extension $\Gamma_0^{(1)}(ND) \setminus \Gamma_0^{(1)}(N)$. The trace from $\Gamma_0^{(1)}(N)$ to $\Gamma_0(N)$ is easy, this will be done at the very end of the calculations.

Since N and D are relatively prime, there are $\mu_1, \mu_2 \in \mathbb{F}_q[T]$ with $1 = \mu_1 N + \mu_2 D$. The set

$$R = \left\{ \begin{pmatrix} 1 & 0 \\ 0 & 1 \end{pmatrix}, \begin{pmatrix} 1 & 1 \\ -\mu_2 D & \mu_1 N \end{pmatrix} \begin{pmatrix} 0 & -1 \\ 1 & \lambda \end{pmatrix} \pmod{D} \right\} \quad (2.3.1)$$

is therefore a set of representatives of $\Gamma_0^{(1)}(ND) \setminus \Gamma_0^{(1)}(N)$. Here we used the assumption that D is irreducible. In order to evaluate $\sum_{M \in R} \Theta_{a_0, \lambda_0} H_{2,s}(M \cdot)$, we treat Θ_{a_0, λ_0} and $H_{2,s}$ separately.

From ([Rül], Prop. 4.4) we get, if $m > v_\infty(u)$:

$$\Theta_{a_0, \lambda_0}\left(\begin{pmatrix} \frac{\pi_\infty^m}{u^2} & \frac{1}{u} \\ 0 & 1 \end{pmatrix}\right) = \Theta_{a_0, \lambda_0}\left(\begin{pmatrix} \frac{\pi_\infty^m}{D} & \frac{u}{D} \\ 0 & 1 \end{pmatrix}\right) \delta_u q^{-v_\infty(u)} \delta_{-\lambda_0} q^{-\frac{1}{2} \deg D} \epsilon_0^{-1}$$

where $\epsilon_0 = 1$ if $\deg D$ is even and $\epsilon_0 = \delta_{-t} (-1)^{\alpha+1} \gamma(p)^\alpha$ ($q = p^\alpha$; $\gamma(p) = 1$ if $p \equiv 1 \pmod 4$ or i otherwise) if $\deg D$ is odd. Then one evaluates

$$\Theta_{a_0, \lambda_0}\left(\begin{pmatrix} 0 & -1 \\ 1 & \lambda \end{pmatrix} \begin{pmatrix} \pi_\infty^m & u \\ 0 & 1 \end{pmatrix}\right) = \Theta_{a_0, \lambda_0}\left(\begin{pmatrix} \frac{\pi_\infty^m}{D} & \frac{-(u+\lambda)}{D} \\ 0 & 1 \end{pmatrix}\right) \cdot \delta_{u+\lambda} q^{-v_\infty(u+\lambda)} \delta_{\lambda_0} q^{-\frac{1}{2} \deg D} \epsilon_0^{-1}.$$

Now (2.2.5) and (2.3.2) yield the operation of the matrices $M \in R$ (cf. (2.3.1)) on Θ_{a_0, λ_0} .

The situation for $H_{2,s}$ and hence for the Eisenstein series $E_s^{(1)}$ (cf. (2.2.6)) is easier. Straightforward calculations (mainly transformations of the summation indices) yield:

If $\begin{pmatrix} a & b \\ c & d \end{pmatrix} \in SL_2(\mathbb{F}_q[T])$ with $\gcd(c, D) = 1$ and if $v_\infty(c\pi_\infty^m) > v_\infty(cu + d)$ then

$$E_s^{(1)}\left(\begin{pmatrix} a & b \\ c & d \end{pmatrix} \begin{pmatrix} \pi_\infty^m & u \\ 0 & 1 \end{pmatrix}\right) = E_s^{(D)}\left(\begin{pmatrix} \frac{\pi_\infty^m}{D} & \frac{u+c^*d}{D} \\ 0 & 1 \end{pmatrix}\right) \left[\frac{c}{D}\right] \cdot \delta_D q^{-(2s+1) \deg D} \delta_{cu+d} q^{-v_\infty(cu+d)(2s+1)} \tag{2.3.3}$$

with $c^* \equiv c^{-1} \pmod{D}$. Here $E_s^{(D)}$ is the Eisenstein series

$$E_s^{(D)}\left(\begin{pmatrix} \pi_\infty^m & u \\ 0 & 1 \end{pmatrix}\right) := \sum_{\substack{c, d \in \mathbb{F}_q[T] \\ v_\infty(c\pi_\infty^m) > v_\infty(cu+d)}} \left[\frac{c}{D}\right] \delta_{cu+d} q^{v_\infty(cu+d)(2s+1)}. \tag{2.3.4}$$

2.3.1 $\deg D$ IS ODD

We apply the results of this section ((2.3.2) and (2.3.3)) to Proposition 2.2.2.

Let $G(N)$ be the set $\Gamma_0^{(1)}(N) \backslash GL_2(K_\infty) / \Gamma_\infty K_\infty^*$.

PROPOSITION 2.3.1 *Let $\deg D$ be odd, then*

$$L^{(N,D)}(2s+1)L(f, \mathcal{A}, s) = \frac{q}{2(q-1)} \int_{G(N)} f \cdot \overline{\Phi_s^{(o)}}$$

with

$$\begin{aligned} \Phi_s^{(o)}\left(\begin{pmatrix} \pi_\infty^m & u \\ 0 & 1 \end{pmatrix}\right) &:= \sum_{M \in R} \Theta_{a_0, \lambda_0} H_{2,s}(M \begin{pmatrix} \pi_\infty^m & u \\ 0 & 1 \end{pmatrix}) \\ &= q^{-\deg D} \sum_{\lambda \pmod{D}} \Theta_{a_0, \lambda_0}\left(\begin{pmatrix} \frac{\pi_\infty^m}{D} & \frac{-(u+\lambda)}{D} \\ 0 & 1 \end{pmatrix}\right) \mathcal{E}_s\left(\begin{pmatrix} \frac{\pi_\infty^m}{D} & \frac{u+\lambda}{D} \\ 0 & 1 \end{pmatrix}\right) \end{aligned} \tag{2.3.5}$$

where $\mathcal{E}_s\left(\begin{pmatrix} \pi_\infty^m & u \\ 0 & 1 \end{pmatrix}\right)$

$$\begin{aligned} &:= q^{(s+1) \deg D + 2s} q^{-m(s+1)} \left[E_s^{(1)}\left(\begin{pmatrix} ND\pi_\infty^m & NDu \\ 0 & 1 \end{pmatrix}\right) \right. \\ &\quad \left. + E_s^{(D)}\left(\begin{pmatrix} N\pi_\infty^m & Nu \\ 0 & 1 \end{pmatrix}\right) \delta_{\lambda_0 DN} \epsilon_0^{-1} \left[\frac{D}{N}\right] q^{(-\frac{1}{2}-2s) \deg D} \right]. \end{aligned} \tag{2.3.6}$$

2.3.2 $\deg D$ IS EVEN

We already mentioned that the factor $((-1)^{m-\deg \lambda_0} + 1)/2$ is invariant under the whole group $GL_2(\mathbb{F}_q[T])$. Therefore it is not affected by the trace. Proposition 2.2.3 yields the following.

PROPOSITION 2.3.2 *Let $\deg D$ be even, then*

$$\frac{1}{1 + q^{-s-1}} L^{(N,D)}(2s + 1)L(f, \mathcal{A}, s) = \frac{q}{2(q-1)} \int_{G(N)} f \cdot \overline{\Phi_s^{(e)}}$$

with

$$\Phi_s^{(e)}\left(\begin{pmatrix} \pi_\infty^m & u \\ 0 & 1 \end{pmatrix}\right) := \Phi_s^{(o)}\left(\begin{pmatrix} \pi_\infty^m & u \\ 0 & 1 \end{pmatrix}\right) \frac{(-1)^{m-\deg \lambda_0} + 1}{2}. \tag{2.3.7}$$

2.4 HOLOMORPHIC PROJECTION

We want to evaluate an integral $\int_{G(N)} f \cdot \overline{\Phi}$, where f is our automorphic cusp form of Drinfeld type of level N (cf. section 2.1) and Φ is any function on $G(N) = \Gamma_0^{(1)}(N) \backslash GL_2(K_\infty) / \Gamma_\infty K_\infty^*$. Since the Petersson product is non-degenerate on cusp forms, we find an automorphic cusp form Ψ of Drinfeld type for $\Gamma_0^{(1)}(N)$ (one has to modify the definition of cusp forms to $\Gamma_0^{(1)}(N)$ in an obvious way) such that

$$\int_{G(N)} g \cdot \overline{\Psi} = \int_{G(N)} g \cdot \overline{\Phi}$$

for all cusp forms g .

If we set $g = f$ we obtain our result. In this section we want to show how one can compute the Fourier coefficients of Ψ from those of Φ . We already noticed that only the coefficients $\Psi^*(\pi_\infty^{\deg \lambda + 2}, \lambda)$ are important (cf. Remark 2.1.2).

For this we take $g = P_\lambda$, where P_λ ($\lambda \in \mathbb{F}_q[T], \lambda \neq 0$) are the Poincaré series introduced in [Rü2], and evaluate (cf. [Rü2], Prop. 14)

$$\int_{G(N)} P_\lambda \cdot \overline{\Psi} = \frac{4}{q-1} \overline{\Psi^*(\pi_\infty^{\deg \lambda + 2}, \lambda)}. \tag{2.4.1}$$

On the other hand we calculate (with transformations as in the proof of [Rü2], Prop. 14)

$$\int_{G(N)} P_\lambda \cdot \overline{\Phi} = 2 \lim_{\sigma \rightarrow 1} \int_{\mathbb{H}_\infty} g_{\lambda, \sigma} \cdot \overline{(\Phi - \tilde{\Phi})} \tag{2.4.2}$$

where

$$g_{\lambda, \sigma} \left(\begin{pmatrix} \pi_\infty^m & u \\ 0 & 1 \end{pmatrix} \right) := \begin{cases} 0 & \text{if } \deg \lambda + 2 > m \\ q^{-m\sigma} \psi_\infty(\lambda u) & \text{if } \deg \lambda + 2 \leq m \end{cases}$$

and where

$$\tilde{\Phi}\left(\begin{pmatrix} \pi_\infty^m & u \\ 0 & 1 \end{pmatrix}\right) := \Phi\left(\begin{pmatrix} \pi_\infty^m & u \\ 0 & 1 \end{pmatrix} \begin{pmatrix} 0 & 1 \\ \pi_\infty & 0 \end{pmatrix}\right). \quad (2.4.3)$$

For these calculations we used again the canonical mapping (cf. section 2.2)

$$\mathbb{H}_\infty \rightarrow G(N).$$

Since \mathbb{H}_∞ represents only the part \mathcal{T}_+ of $GL_2(K_\infty)/\Gamma_\infty K_\infty^*$ (cf. section 2.1) and since Φ is not necessarily harmonic, we also have to consider the function $\tilde{\Phi}$. Using the Fourier expansions

$$\begin{aligned} \Phi\left(\begin{pmatrix} \pi_\infty^m & u \\ 0 & 1 \end{pmatrix}\right) &= \sum_{\mu} \Phi^*(\pi_\infty^m, \mu) \psi_\infty(\mu u) \\ \tilde{\Phi}\left(\begin{pmatrix} \pi_\infty^m & u \\ 0 & 1 \end{pmatrix}\right) &= \sum_{\mu} \tilde{\Phi}^*(\pi_\infty^m, \mu) \psi_\infty(\mu u) \end{aligned}$$

and the character relations for ψ_∞ , (2.4.2) yields

$$\int_{G(N)} P_\lambda \cdot \bar{\Phi} = \frac{2}{q} \lim_{\sigma \rightarrow 0} \sum_{m=\deg \lambda+2}^{\infty} q^{-m\sigma} \overline{(\Phi^*(\pi_\infty^m, \lambda) - \tilde{\Phi}^*(\pi_\infty^m, \lambda))}. \quad (2.4.4)$$

Finally, (2.4.1) and (2.4.4) prove:

PROPOSITION 2.4.1 *Let $\Phi : G(N) = \Gamma_0^{(1)}(N) \backslash GL_2(K_\infty) / \Gamma_\infty K_\infty^* \rightarrow \mathbb{C}$ be any function, then there is an automorphic cusp form Ψ of Drinfeld type for $\Gamma_0^{(1)}(N)$ such that*

$$\int_{G(N)} f \cdot \bar{\Psi} = \int_{G(N)} f \cdot \bar{\Phi}.$$

The Fourier coefficients of Ψ can be evaluated by the formula

$$\Psi^*(\pi_\infty^{\deg \lambda+2}, \lambda) = \frac{q-1}{2q} \lim_{\sigma \rightarrow 0} \sum_{m=\deg \lambda+2}^{\infty} q^{-m\sigma} (\Phi^*(\pi_\infty^m, \lambda) - \tilde{\Phi}^*(\pi_\infty^m, \lambda)),$$

where $\tilde{\Phi}$ is defined in (2.4.3).

Problems could arise since the limit may not exist. We will see this in the following sections, where we apply this holomorphic projection formula to $\Phi_s^{(o)}$, $\Phi_s^{(e)}$ (cf. (2.3.5) and (2.3.7)) or their derivatives.

2.5 FOURIER EXPANSIONS OF $\Phi_s^{(o)}$ AND $\Phi_s^{(e)}$

In this section we evaluate the Fourier coefficients $\Phi_s^{(o)*}(\pi_\infty^m, \lambda)$ and $\Phi_s^{(e)*}(\pi_\infty^m, \lambda)$ (cf. (2.3.5) and (2.3.7)). The function $\Theta_{\mathfrak{a}_0, \lambda_0}$ is already defined by its coefficients $r_{\mathfrak{a}_0, \lambda_0}$. It remains to evaluate the coefficients of \mathcal{E}_s (cf. (2.3.6)) and therefore of the Eisenstein series $E_s^{(1)}$ (cf. (2.2.6)) and $E_s^{(D)}$ (cf. (2.3.4)).

We introduce a “basic function” on $GL_2(K_\infty)/\Gamma_\infty K_\infty^*$:

$$F_s\left(\begin{pmatrix} \pi_\infty^m & u \\ 0 & 1 \end{pmatrix}\right) = \sum_\lambda F_s^*(\pi_\infty^m, \lambda)\psi_\infty(\lambda u) := \sum_{\substack{d \in \mathbb{F}_q[T] \\ m > v_\infty(u+d)}} \delta_{u+d} q^{v_\infty(u+d)(2s+1)}. \tag{2.5.1}$$

We recall that δ_z is the local norm symbol of z at ∞ . At first we express the Eisenstein series in terms of F_s . Elementary transformations give

$$E_s^{(1)}\left(\begin{pmatrix} ND\pi_\infty^m & NDu \\ 0 & 1 \end{pmatrix}\right) = \sum_{\substack{d \in \mathbb{F}_q[T] \\ d \neq 0}} \left[\frac{D}{d}\right] q^{-(2s+1)\deg d} + \delta_D q^{-(2s+1)\deg D} \\ \cdot \sum_{\substack{\mu \in \mathbb{F}_q[T] \\ \mu \neq 0}} \left[\sum_{\substack{c|\mu \\ c \equiv 0 \pmod{D}}} F_s^*(cN\pi_\infty^m, \frac{\mu}{c}) \sum_{d \pmod{D}} \left[\frac{d}{D}\right] \psi_\infty\left(\frac{\mu}{c} \frac{d}{D}\right) \right] \psi_\infty(\mu Nu).$$

The Gauss sum can be evaluated

$$\sum_{d \pmod{D}} \left[\frac{d}{D}\right] \psi_\infty\left(\lambda \frac{d}{D}\right) = \left[\frac{\lambda}{D}\right] \epsilon_0^{-1} q^{\frac{1}{2}\deg D},$$

where ϵ_0 is as in (2.3.2). Therefore

$$E_s^{(1)}\left(\begin{pmatrix} ND\pi_\infty^m & NDu \\ 0 & 1 \end{pmatrix}\right) = \sum_{\substack{d \in \mathbb{F}_q[T] \\ d \neq 0}} \left[\frac{D}{d}\right] q^{-(2s+1)\deg d} + \epsilon_0^{-1} \delta_D q^{(-2s-\frac{1}{2})\deg D} \\ \cdot \sum_{\mu \neq 0} \sum_{\substack{c|\mu \\ c \equiv 0 \pmod{D}}} \left[\frac{\mu/c}{D}\right] F_s^*(cN\pi_\infty^m, \frac{\mu}{c}) \psi_\infty(\mu Nu). \tag{2.5.2}$$

The same transformations as above yield

$$E_s^{(D)}\left(\begin{pmatrix} N\pi_\infty^m & Nu \\ 0 & 1 \end{pmatrix}\right) = \sum_{\substack{d \in \mathbb{F}_q[T] \\ d \neq 0}} \left[\frac{d}{D}\right] F_s^*(dN\pi_\infty^m, 0) + \\ + \sum_{\mu \neq 0} \sum_{c|\mu} \left[\frac{c}{D}\right] F_s^*(cN\pi_\infty^m, \frac{\mu}{c}) \psi_\infty(\mu Nu). \tag{2.5.3}$$

Now we have to evaluate the Fourier coefficients of the “basic function” F_s (cf. (2.5.1)). This is not very difficult, though perhaps a little tedious to write down in detail. One starts with the definition of the coefficients

$$F_s^*(\pi_\infty^m, \lambda) = q^{-m+1} \sum_{u \in \pi_\infty / \pi_\infty^m} F_s\left(\begin{pmatrix} \pi_\infty^m & u \\ 0 & 1 \end{pmatrix}\right) \psi_\infty(-\lambda u)$$

and uses the character relations for ψ_∞ . We do not carry it out in detail. As the local norm symbol δ_z behaves differently we have to distinguish again the two cases.

2.5.1 $\deg D$ IS ODD

L_∞/K_∞ is ramified and the local norm symbol for $z = e_z \pi_\infty^n + \dots$ is given by $\delta_z = \chi_2(e_z) \delta_T^n$ (χ_2 is the quadratic character on \mathbb{F}_q^* ; we recall that $\pi_\infty = T^{-1}$). We get:

LEMMA 2.5.1 *Let $\deg D$ be odd, then*

$$F_s^*(\pi_\infty^m, \mu) = \begin{cases} 0 & , \text{ if either } \mu = 0 \text{ or } \deg \mu + 2 > m \\ \epsilon_0^{-1} q^{\frac{1}{2}} \delta_\mu q^{2s(\deg \mu + 1)} & , \text{ if } \mu \neq 0 \text{ and } \deg \mu + 2 \leq m. \end{cases}$$

Now (2.5.2), (2.5.3), Lemma 2.5.1 and the definition of \mathcal{E}_s in (2.3.6) give:

PROPOSITION 2.5.2 *Let $\deg D$ be odd, then*

$$\mathcal{E}_s\left(\begin{pmatrix} \pi_\infty^m & u \\ 0 & 1 \end{pmatrix}\right) = \sum_{\substack{\mu \in \mathbb{F}_q[T] \\ \deg(\mu N) + 2 \leq m}} e_s(\pi_\infty^m, \mu) \psi_\infty(\mu N u)$$

with

$$e_s(\pi_\infty^m, 0) = q^{(s+1) \deg D + 2s - m(s+1)} \sum_{\substack{d \in \mathbb{F}_q[T] \\ d \neq 0}} \left[\frac{D}{d}\right] q^{-(2s+1) \deg d} \tag{2.5.4}$$

and ($\mu \neq 0$)

$$e_s(\pi_\infty^m, \mu) = q^{(-s + \frac{1}{2}) \deg D + 4s + \frac{1}{2} - m(s+1) + 2s \deg \mu} \cdot \left(\sum_{\substack{c|\mu \\ c \equiv 0 \pmod{D}}} \left[\frac{D}{\mu/c}\right] q^{-2s \deg c} + \delta_{\lambda_0 N \mu} \left[\frac{D}{N}\right] \sum_{c|\mu} \left[\frac{D}{c}\right] q^{-2s \deg c} \right). \tag{2.5.5}$$

2.5.2 $\deg D$ IS EVEN

L_∞/K_∞ is inert and the local norm symbol for $z = e_z \pi_\infty^n + \dots$ is given by $\delta_z = (-1)^n$. We get:

LEMMA 2.5.3 *Let deg D be even, then*

$$F_s^*(\pi_\infty^m, 0) = \frac{1-q}{q^{2s}+1}(-q^{2s})^m,$$

and ($\mu \neq 0$ with $\deg \mu + 2 \leq m$)

$$F_s^*(\pi_\infty^m, \mu) = \frac{(-q^{2s})^{\deg \mu + 1}}{q^{2s}+1}((1-q)(-q^{2s})^{m-\deg \mu - 1} - 1 - q^{2s+1}).$$

Again (2.5.2), (2.5.3), Lemma 2.5.3 and the definition of \mathcal{E}_s in (2.3.6) give:

PROPOSITION 2.5.4 *Let deg D be even, then*

$$\mathcal{E}_s\left(\begin{pmatrix} \pi_\infty^m & u \\ 0 & 1 \end{pmatrix}\right) = \sum_{\substack{\mu \in \mathbb{F}_q[T] \\ \deg(\mu N) + 2 \leq m}} e_s(\pi_\infty^m, \mu) \psi_\infty(\mu Nu)$$

with

$$\begin{aligned} e_s(\pi_\infty^m, 0) &= q^{\deg D(s+1) - m(s+1) + 2s} \left(\sum_{\substack{d \in \mathbb{F}_q[T] \\ d \neq 0}} \left[\frac{D}{d} \right] q^{-(2s+1) \deg d} \right. \\ &\quad \left. + \frac{1-q}{q^{2s}+1} q^{\deg D(-\frac{1}{2}-2s) + 2sm - 2s \deg N} \right. \\ &\quad \left. (-1)^{\deg \lambda_0 + m} \left[\frac{D}{N} \right] \sum_{\substack{d \in \mathbb{F}_q[T] \\ d \neq 0}} \left[\frac{D}{d} \right] q^{-2s \deg d} \right) \end{aligned} \tag{2.5.6}$$

and ($\mu \neq 0$)

$$\begin{aligned} e_s(\pi_\infty^m, \mu) &= q^{m(-s-1) + 2s + \deg D(-s + \frac{1}{2})}. \tag{2.5.7} \\ \left(\sum_{\substack{c|\mu \\ c \equiv 0 \pmod{D}}} \left[\frac{D}{\mu/c} \right] q^{-2s \deg c} \right) &\left(\frac{1-q}{q^{2s}+1} (-1)^{m - \deg N - \deg \mu} q^{2s(m - \deg N)} \right. \\ &\quad \left. + \frac{q^{2s+1} + 1}{q^{2s} + 1} q^{2s(\deg \mu + 1)} \right) \\ &+ \left[\frac{D}{N} \right] \left(\sum_{c|\mu} \left[\frac{D}{c} \right] q^{-2s \deg c} \right) \left(\frac{1-q}{q^{2s}+1} (-1)^{\deg \lambda_0 + m} q^{2s(m - \deg N)} \right. \\ &\quad \left. + \frac{q^{2s+1} + 1}{q^{2s} + 1} (-1)^{\deg \lambda_0 + \deg N + \deg \mu} q^{2s(\deg \mu + 1)} \right). \end{aligned}$$

2.6 FOURIER EXPANSIONS OF $\widetilde{\Phi}_s^{(o)}$ AND $\widetilde{\Phi}_s^{(e)}$

In accordance with (2.4.3) let $\widetilde{\Phi}_s^{(o)}$ (resp. $\widetilde{\Phi}_s^{(e)}$) on $GL_2(K_\infty)/\Gamma_\infty K_\infty^*$ be defined as $\widetilde{\Phi}_s^{(o)}(X) = \Phi_s^{(o)}\left(X \begin{pmatrix} 0 & 1 \\ \pi_\infty & 0 \end{pmatrix}\right)$ (resp. $\widetilde{\Phi}_s^{(e)}(X) = \Phi_s^{(e)}\left(X \begin{pmatrix} 0 & 1 \\ \pi_\infty & 0 \end{pmatrix}\right)$).

The situation is more complicated than in the last section. To extend functions canonically from \mathcal{T}_+ (cf. (2.1.1)) to the whole of $GL_2(K_\infty)/\Gamma_\infty K_\infty^*$ we need the following proposition.

PROPOSITION 2.6.1 *Let $\chi_D : (\mathbb{F}_q[T]/D\mathbb{F}_q[T])^* \rightarrow \mathbb{C}^*$ be a character modulo D and let $\chi_\infty : K_\infty^* \rightarrow \mathbb{C}^*$ be a character which vanishes on the subgroup of 1-units $O_\infty^{(1)} = \{x \in K_\infty^* \mid v_\infty(x - 1) > 0\}$.
Let $F : \mathcal{T}_+ \rightarrow \mathbb{C}$ be a function which satisfies*

$$F\left(\begin{pmatrix} a & b \\ c & d \end{pmatrix} \begin{pmatrix} \pi_\infty^m & u \\ 0 & 1 \end{pmatrix}\right) = F\left(\begin{pmatrix} \pi_\infty^m & u \\ 0 & 1 \end{pmatrix}\right) \chi_D(d) \chi_\infty(cu + d),$$

for all $\begin{pmatrix} a & b \\ c & d \end{pmatrix} \in \Gamma_0^{(1)}(D)$ with $\begin{pmatrix} a & b \\ c & d \end{pmatrix} \begin{pmatrix} \pi_\infty^m & u \\ 0 & 1 \end{pmatrix} \in \mathcal{T}_+$.

Then F can be defined on $GL_2(K_\infty)/\Gamma_\infty K_\infty^*$ with

$$F\left(\begin{pmatrix} a & b \\ c & d \end{pmatrix} \begin{pmatrix} \pi_\infty^m & u \\ 0 & 1 \end{pmatrix}\right) = F\left(\begin{pmatrix} \pi_\infty^m & u \\ 0 & 1 \end{pmatrix}\right) \chi_D(d) \cdot \begin{cases} \chi_\infty(cu + d) & , \text{ if } v_\infty(c\pi_\infty^m) > v_\infty(cu + d) \\ \chi_\infty(c^{-1}) & , \text{ if } v_\infty(c\pi_\infty^m) \leq v_\infty(cu + d). \end{cases} \quad (2.6.1)$$

PROOF. We already know that $\begin{pmatrix} a & b \\ c & d \end{pmatrix} \begin{pmatrix} \pi_\infty^m & u \\ 0 & 1 \end{pmatrix} \in \mathcal{T}_+$ is equivalent to $v_\infty(c\pi_\infty^m) > v_\infty(cu + d)$ (cf. Remark 2.2.1). For each $X \in GL_2(K_\infty)/\Gamma_\infty K_\infty^*$ there is $A \in \Gamma_0^{(1)}(D)$ and $\begin{pmatrix} \pi_\infty^m & u \\ 0 & 1 \end{pmatrix} \in \mathcal{T}_+$ such that $X = A \begin{pmatrix} \pi_\infty^m & u \\ 0 & 1 \end{pmatrix}$ in $GL_2(K_\infty)/\Gamma_\infty K_\infty^*$. Then we define $F(X)$ by equation (2.6.1). The assumption on F guarantees that this definition is independent of the choice of A and $\begin{pmatrix} \pi_\infty^m & u \\ 0 & 1 \end{pmatrix}$. □

We apply this proposition to Θ_{a_0, λ_0} (cf. (2.1.10)) and to the Eisenstein series. The Eisenstein series $E_s^{(i)}$ ($i = 1, D$) (cf. (2.2.6), (2.3.4)) satisfy

$$E_s^{(i)}\left(\begin{pmatrix} a & b \\ c & d \end{pmatrix} \begin{pmatrix} \pi_\infty^m & u \\ 0 & 1 \end{pmatrix}\right) = E_s^{(i)}\left(\begin{pmatrix} \pi_\infty^m & u \\ 0 & 1 \end{pmatrix}\right) \cdot \left[\frac{d}{D}\right] \delta_{cu+d} q^{-v_\infty(cu+d)(2s+1)}$$

if $\begin{pmatrix} a & b \\ c & d \end{pmatrix} \in \Gamma_0^{(1)}(D)$ and $v_\infty(c\pi_\infty^m) > v_\infty(cu + d)$. We can apply Proposition 2.6.1 with $\chi_D(d) = \left[\frac{d}{D}\right]$ and $\chi_\infty(z) = \delta_z q^{-v_\infty(z)(2s+1)}$.

Hence

$$E_s^{(1)}\left(\begin{pmatrix} \pi_\infty^m & u \\ 0 & 1 \end{pmatrix} \begin{pmatrix} 0 & 1 \\ \pi_\infty & 0 \end{pmatrix}\right) = \sum_{\substack{c, d \in \mathbb{F}_q[T] \\ c \equiv 0 \pmod{D} \\ v_\infty(c\pi_\infty^m) \leq v_\infty(cu+d)}} \left[\frac{d}{D}\right] \delta_{-c} q^{v_\infty(c)(2s+1)}$$

and

$$E_s^{(D)}\left(\begin{pmatrix} \pi_\infty^m & u \\ 0 & 1 \end{pmatrix} \begin{pmatrix} 0 & 1 \\ \pi_\infty & 0 \end{pmatrix}\right) = \sum_{\substack{c,d \in \mathbb{F}_q[T] \\ v_\infty(c\pi_\infty^m) \leq v_\infty(cu+d)}} \left[\frac{c}{D}\right] \delta_{-c} q^{v_\infty(c)(2s+1)}.$$

We denote these functions by $\widetilde{E}_s^{(1)}$ and $\widetilde{E}_s^{(D)}$ as above. Starting with the definition of the Fourier coefficients we calculate

$$\begin{aligned} \widetilde{E}_s^{(1)}\left(\begin{pmatrix} ND\pi_\infty^m & NDu \\ 0 & 1 \end{pmatrix}\right) &= \sum_{\substack{\mu \neq 0 \\ \deg(\mu N)+2 \leq m}} \left[\epsilon_0 q^{\deg D(-2s-\frac{1}{2})+\deg N(-2s)+1-m} \right. \\ &\quad \cdot \delta_{\mu ND} \sum_{\substack{c|\mu \\ c \equiv 0 \pmod{D}}} \left[\frac{D}{\mu/c}\right] q^{-2s \deg c} \left. \right] \psi_\infty(\mu Nu) \end{aligned} \tag{2.6.2}$$

and

$$\begin{aligned} \widetilde{E}_s^{(D)}\left(\begin{pmatrix} N\pi_\infty^m & Nu \\ 0 & 1 \end{pmatrix}\right) &= q^{\deg N(-2s)+1-m} \delta_{-N} \sum_{c \neq 0} \left[\frac{D}{c}\right] q^{-2s \deg c} + \\ &+ \sum_{\substack{\mu \neq 0 \\ \deg(\mu N)+2 \leq m}} \left[q^{\deg N(-2s)+1-m} \delta_{-N} \sum_{c|\mu} \left[\frac{D}{c}\right] q^{-2s \deg c} \right] \psi_\infty(\mu Nu). \end{aligned} \tag{2.6.3}$$

In addition we have $q^{-\widetilde{m}(s+1)} = q^{-(1-m)(s+1)}$, therefore (2.6.2) and (2.6.3) give:

PROPOSITION 2.6.2 *Let $\deg D$ be odd or even, then*

$$\widetilde{\mathcal{E}}_s\left(\begin{pmatrix} \pi_\infty^m & u \\ 0 & 1 \end{pmatrix}\right) := \mathcal{E}_s\left(\begin{pmatrix} \pi_\infty^m & u \\ 0 & 1 \end{pmatrix} \begin{pmatrix} 0 & 1 \\ \pi_\infty & 0 \end{pmatrix}\right) = \sum_{\substack{\mu \in \mathbb{F}_q[T] \\ \deg(\mu N)+2 \leq m}} \widetilde{e}_s(\pi_\infty^m, \mu) \psi_\infty(\mu Nu)$$

with

$$\widetilde{e}_s(\pi_\infty^m, 0) = q^{\deg D(-s+\frac{1}{2})+\deg N(-2s)+ms+s} \epsilon_0^{-1} \delta_{\lambda_0} \left[\frac{D}{N}\right] \sum_{d \neq 0} \left[\frac{D}{c}\right] q^{-2s \deg d} \tag{2.6.4}$$

and ($\mu \neq 0$)

$$\begin{aligned} \widetilde{e}_s(\pi_\infty^m, \mu) &= q^{\deg D(-s+\frac{1}{2})+\deg N(-2s)+ms+s} \epsilon_0^{-1} \cdot \\ &\quad \left(\delta_{\mu N} \sum_{\substack{c|\mu \\ c \equiv 0 \pmod{D}}} \left[\frac{D}{\mu/c}\right] q^{-2s \deg c} + \delta_{\lambda_0} \left[\frac{D}{N}\right] \sum_{c|\mu} \left[\frac{D}{c}\right] q^{-2s \deg c} \right). \end{aligned} \tag{2.6.5}$$

For $\Theta_{\mathfrak{a}_0, \lambda_0}$ it is not just straightforward calculation. In the following we make use of the fact that the Fourier coefficients $r_{\mathfrak{a}_0, \lambda_0}(\lambda)$ of $\Theta_{\mathfrak{a}_0, \lambda_0}$ are independent of π_∞^m if $\deg \lambda + 2 \leq m$.

$\Theta_{\mathfrak{a}_0, \lambda_0}$ satisfies Proposition 2.6.1 with $\chi_D(d) = \left[\frac{d}{D} \right]$ and $\chi_\infty(z) = \delta_z q^{-v_\infty(z)}$ (cf. (2.2.5)). Again we denote $\widetilde{\Theta}_{\mathfrak{a}_0, \lambda_0}(\cdot) = \Theta_{\mathfrak{a}_0, \lambda_0}(\cdot \begin{pmatrix} 0 & 1 \\ \pi_\infty & 0 \end{pmatrix})$.

Let $\pi_\infty^m \in K_\infty^*$ and $u \in K_\infty$. Choose $c, d \in \mathbb{F}_q[T]$ with $c \equiv 0 \pmod D$, $\gcd(c, d) = 1$ and $v_\infty(u + \frac{d}{c}) \geq m + 1$ and find $a, b \in \mathbb{F}_q[T]$ with $ad - bc = 1$. Then for all $k \in \mathbb{Z}$ with $k \leq m + 1$ there is the following identity in $GL_2(K_\infty)/\Gamma_\infty K_\infty^*$:

$$\begin{pmatrix} \pi_\infty^k & u \\ 0 & 1 \end{pmatrix} \begin{pmatrix} 0 & 1 \\ \pi_\infty & 0 \end{pmatrix} = \begin{pmatrix} d & -b \\ -c & a \end{pmatrix} \begin{pmatrix} \frac{\pi_\infty^{1-k}}{c^2} & \frac{a}{c} \\ 0 & 1 \end{pmatrix}$$

We use this identity for $k = m$ and $k = m + 1$. Then Proposition 2.6.1 gives

$$\begin{aligned} \widetilde{\Theta}_{\mathfrak{a}_0, \lambda_0} \left(\begin{pmatrix} \pi_\infty^m & u \\ 0 & 1 \end{pmatrix} \right) - \widetilde{\Theta}_{\mathfrak{a}_0, \lambda_0} \left(\begin{pmatrix} \pi_\infty^{m+1} & u \\ 0 & 1 \end{pmatrix} \right) &= \left[\frac{d}{D} \right] \delta_{-c} q^{v_\infty(c)} \cdot \\ &\cdot \sum_{\deg \mu + 2 = 1 - m + 2 \deg c} r_{\mathfrak{a}_0, \lambda_0}(\mu) \psi_\infty \left(\mu \frac{a}{c} \right). \end{aligned} \tag{2.6.6}$$

On the other hand we set $u_\epsilon = -\frac{d}{c} + \epsilon \pi_\infty^m$ for $\epsilon \in \mathbb{F}_q^*$, we compare $\frac{a}{c}$ with $\frac{au_\epsilon + b}{cu_\epsilon + d}$ and sum over all ϵ :

$$\begin{aligned} (q-1) \widetilde{\Theta}_{\mathfrak{a}_0, \lambda_0} \left(\begin{pmatrix} \pi_\infty^m & u \\ 0 & 1 \end{pmatrix} \right) - \left[\frac{d}{D} \right] \delta_{-c} q^{v_\infty(c)} \sum_{\epsilon \in \mathbb{F}_q^*} \Theta_{\mathfrak{a}_0, \lambda_0} \left(\begin{pmatrix} \frac{\pi_\infty^{1-m}}{c^2} & \frac{au_\epsilon + b}{cu_\epsilon + d} \\ 0 & 1 \end{pmatrix} \right) \\ = q \left[\frac{d}{D} \right] \delta_{-c} q^{v_\infty(c)} \sum_{\deg \mu + 2 = 1 - m + 2 \deg c} r_{\mathfrak{a}_0, \lambda_0}(\mu) \psi_\infty \left(\mu \frac{a}{c} \right). \end{aligned} \tag{2.6.7}$$

Now

$$\begin{pmatrix} \frac{\pi_\infty^{1-m}}{c^2} & \frac{au_\epsilon + b}{cu_\epsilon + d} \\ 0 & 1 \end{pmatrix} = \begin{pmatrix} a & b \\ c & d \end{pmatrix} \begin{pmatrix} \pi_\infty^{m+1} & u_\epsilon \\ 0 & 1 \end{pmatrix}$$

in $GL_2(K_\infty)/\Gamma_\infty K_\infty^*$. We use this to evaluate the corresponding value of $\Theta_{\mathfrak{a}_0, \lambda_0}$. A combination of (2.6.6) and (2.6.7) therefore gives

$$\begin{aligned} q \widetilde{\Theta}_{\mathfrak{a}_0, \lambda_0} \left(\begin{pmatrix} \pi_\infty^{m+1} & u \\ 0 & 1 \end{pmatrix} \right) - \widetilde{\Theta}_{\mathfrak{a}_0, \lambda_0} \left(\begin{pmatrix} \pi_\infty^m & u \\ 0 & 1 \end{pmatrix} \right) \\ = \delta_{-\pi_\infty^m} q^{-m} \sum_{\epsilon \in \mathbb{F}_q^*} \delta_\epsilon \Theta_{\mathfrak{a}_0, \lambda_0} \left(\begin{pmatrix} \pi_\infty^{m+1} & u + \epsilon \pi_\infty^m \\ 0 & 1 \end{pmatrix} \right). \end{aligned} \tag{2.6.8}$$

If we evaluate in (2.6.8) the Fourier coefficients at λ with $\deg \lambda + 2 \leq m$, we get the recursion formula

$$q \widetilde{\Theta}_{\mathfrak{a}_0, \lambda_0}^* (\pi_\infty^{m+1}, \lambda) - \widetilde{\Theta}_{\mathfrak{a}_0, \lambda_0}^* (\pi_\infty^m, \lambda) = \delta_{\pi_\infty^m} q^{-m} \sum_{\epsilon \in \mathbb{F}_q^*} \delta_\epsilon r_{\mathfrak{a}_0, \lambda_0}(\lambda). \tag{2.6.9}$$

The Fourier coefficient in (2.6.8) at λ with $\deg \lambda + 2 = m + 1$ yields

$$q \widetilde{\Theta}_{\mathfrak{a}_0, \lambda_0}^* (\pi_\infty^{\deg \lambda + 2}, \lambda) = \delta_{\pi_\infty^{\deg \lambda + 1}} q^{-\deg \lambda - 1} \sum_{\epsilon \in \mathbb{F}_q^*} \delta_\epsilon \psi_\infty(-\lambda \epsilon \pi_\infty^{\deg \lambda + 1}) r_{\mathfrak{a}_0, \lambda_0}(\lambda). \tag{2.6.10}$$

For $\lambda = 0$ we calculate

$$\widetilde{\Theta}_{\mathfrak{a}_0, \lambda_0}^* (\pi_\infty, 0) = q^{-\frac{1}{2} \deg D} \delta_{\lambda_0} \epsilon_0^{-1} \sum_{\deg \mu + 2 \leq \deg D} r_{\mathfrak{a}_0, \lambda_0}(\mu). \tag{2.6.11}$$

It is now obvious how one evaluates $\widetilde{\Theta}_{\mathfrak{a}_0, \lambda_0}^* (\pi_\infty^m, \lambda)$ with the recursion formula (2.6.9) and the starting values (2.6.10) and (2.6.11). Here again we have to consider the two cases separately.

PROPOSITION 2.6.3 *Let $\deg D$ be odd, then*

$$\widetilde{\Theta}_{\mathfrak{a}_0, \lambda_0}^* \left(\begin{pmatrix} \pi_\infty^m & u \\ 0 & 1 \end{pmatrix} \right) = \sum_{\deg \lambda + 2 \leq m} \widetilde{\Theta}_{\mathfrak{a}_0, \lambda_0}^* (\pi_\infty^m, \lambda) \psi_\infty(\lambda u)$$

with

$$\widetilde{\Theta}_{\mathfrak{a}_0, \lambda_0}^* (\pi_\infty^m, \lambda) = q^{\frac{1}{2}} q^{-m} \epsilon_0^{-1} \delta_{\lambda_0} r_{\mathfrak{a}_0, \lambda_0}(\lambda). \tag{2.6.12}$$

PROPOSITION 2.6.4 *Let $\deg D$ be even, then*

$$\widetilde{\Theta}_{\mathfrak{a}_0, \lambda_0}^* \left(\begin{pmatrix} \pi_\infty^m & u \\ 0 & 1 \end{pmatrix} \right) = \sum_{\deg \lambda + 2 \leq m} \widetilde{\Theta}_{\mathfrak{a}_0, \lambda_0}^* (\pi_\infty^m, \lambda) \psi_\infty(\lambda u)$$

with

$$\widetilde{\Theta}_{\mathfrak{a}_0, \lambda_0}^* (\pi_\infty^m, \lambda) = q^{-m} (-1)^{\deg \lambda_0} \left(\frac{q+1}{2} + \frac{q-1}{2} (-1)^{m+\deg \lambda_0-1} \right) r_{\mathfrak{a}_0, \lambda_0}(\lambda). \tag{2.6.13}$$

2.7 FUNCTIONAL EQUATIONS

In this section we modify the representations of the L -series of Proposition 2.3.1 and Proposition 2.3.2. With these new formulas we can prove functional equations for the L -series. Later we will use them to get our final results.

2.7.1 $\deg D$ IS ODD

Since f is an automorphic cusp form of Drinfeld type and therefore satisfies (cf. Definition 2.1.1)

$$f\left(X \begin{pmatrix} 0 & 1 \\ \pi_\infty & 0 \end{pmatrix}\right) = -f(X) \text{ for all } X \in GL_2(K_\infty)/\Gamma_\infty K_\infty^*,$$

we can transform the integral in Proposition 2.3.1, and get:

LEMMA 2.7.1 *Let deg D be odd, then*

$$L^{(N,D)}(2s + 1)L(f, \mathcal{A}, s) = \frac{q}{4(q - 1)} \int_{G(N)} f \cdot \overline{F_s^{(o)}}$$

with

$$F_s^{(o)}(X) := \Phi_s^{(o)}(X) - \widetilde{\Phi_s^{(o)}}(X),$$

whose Fourier coefficients are

$$F_s^{(o)*}(\pi_\infty^m, \lambda) = -\widetilde{F_s^{(o)*}}(\pi_\infty^m, \lambda) = \Phi_s^{(o)*}(\pi_\infty^m, \lambda) - \widetilde{\Phi_s^{(o)*}}(\pi_\infty^m, \lambda).$$

Now we evaluate $F_s^{(o)*}(\pi_\infty^m, \lambda)$. We start with the definition (cf. Proposition 2.3.1)

$$\begin{aligned} \Phi_s^{(o)}\left(\begin{pmatrix} \pi_\infty^m & u \\ 0 & 1 \end{pmatrix}\right) &= q^{-\deg D} \cdot \\ &\cdot \sum_{\lambda \bmod D} \Theta_{\mathfrak{a}_0, \lambda_0}\left(\begin{pmatrix} \frac{\pi_\infty^m}{D} & \frac{-(u+\lambda)}{D} \\ 0 & 1 \end{pmatrix}\right) \mathcal{E}_s\left(\begin{pmatrix} \frac{\pi_\infty^m}{D} & \frac{u+\lambda}{D} \\ 0 & 1 \end{pmatrix}\right) \end{aligned}$$

and use the Fourier coefficients of $\Theta_{\mathfrak{a}_0, \lambda_0}$ (cf. (2.1.10)) and \mathcal{E}_s (cf. (2.3.6) and Proposition 2.5.2) to evaluate

$$\Phi_s^{(o)*}(\pi_\infty^m, \lambda) = \sum_{\substack{\mu \in \mathbb{F}_q[T] \\ \deg(\mu N) + 2 \leq m + \deg D}} r_{\mathfrak{a}_0, \lambda_0}(\mu N - \lambda D) e_s(\pi_\infty^{m+\deg D}, \mu). \tag{2.7.1}$$

On the other hand, if $\begin{pmatrix} a & b \\ c & d \end{pmatrix} \in SL_2(\mathbb{F}_q[T])$ with $b, c \equiv 0 \pmod D$ and if u is such that $v_\infty(u + d/c) \geq m$, then we have (using the transformation rules of $\Theta_{\mathfrak{a}_0, \lambda_0}$ and \mathcal{E}_s):

$$\widetilde{\Phi_s^{(o)}}\left(\begin{pmatrix} \pi_\infty^m & u \\ 0 & 1 \end{pmatrix}\right) = \Phi_s^{(o)}\left(\begin{pmatrix} \frac{\pi_\infty^{1-m}}{c^2} & \frac{a}{c} \\ 0 & 1 \end{pmatrix}\right).$$

When we expand this equation with Fourier coefficients, we get

$$\widetilde{\Phi_s^{(o)*}}(\pi_\infty^m, \lambda) = \sum_{\substack{\mu \in \mathbb{F}_q[T] \\ \deg(\mu N) + 2 \leq m + \deg D}} \widetilde{\Theta_{\mathfrak{a}_0, \lambda_0}^*}(\pi_\infty^{m+\deg D}, \mu N - \lambda D) \widetilde{e}_s(\pi_\infty^{m+\deg D}, \mu) \delta_D. \tag{2.7.2}$$

Now we replace e_s , $\widetilde{\Theta_{\mathfrak{a}_0, \lambda_0}^*}$ and \widetilde{e}_s in (2.7.1) and (2.7.2) by (2.5.5), (2.6.12) and (2.6.5), and we get:

PROPOSITION 2.7.2 *Let deg D be odd and deg λ + 2 ≤ m, then*

$$\begin{aligned} & \Phi_s^{(o)*}(\pi_\infty^m, \lambda) - \widetilde{\Phi}_s^{(o)*}(\pi_\infty^m, \lambda) = r_{\mathfrak{a}_0, \lambda_0}(-\lambda D) q^{-m - \frac{1}{2} \deg D + \frac{1}{2}} \cdot \\ & \left(\sum_{\substack{d \in \mathbb{F}_q[T] \\ d \neq 0}} \left[\frac{D}{d} \right] q^{-(2s+1) \deg d} \right) q^{-ms + 2s + \frac{1}{2} \deg D - \frac{1}{2}} \\ & - \left(\sum_{\substack{d \in \mathbb{F}_q[T] \\ d \neq 0}} \left[\frac{D}{d} \right] q^{-2s \deg d} \right) \left[\frac{D}{N} \right] q^{ms - 2s \deg N + s} \\ & + \sum_{\substack{\mu \in \mathbb{F}_q[T], \mu \neq 0 \\ \deg(\mu N) + 2 \leq m + \deg D}} r_{\mathfrak{a}_0, \lambda_0}(\mu N - \lambda D) q^{-m - \frac{1}{2} \deg D + \frac{1}{2}} \cdot \\ & \left(\sum_{\substack{c|\mu \\ c \equiv 0 \pmod{D}}} \left[\frac{D}{\mu/c} \right] q^{-2s \deg c} \right) (q^{-2s \deg D - ms + 4s + 2s \deg \mu} - \delta_{\lambda_0 N \mu} q^{ms - 2s \deg N + s}) \\ & + \left(\sum_{c|\mu} \left[\frac{D}{c} \right] q^{-2s \deg c} \right) \left[\frac{D}{N} \right] (\delta_{\lambda_0 N \mu} q^{-2s \deg D - ms + 4s + 2s \deg \mu} - q^{ms - 2s \deg N + s}). \end{aligned}$$

With these formulas we prove the following result:

THEOREM 2.7.3 *Let deg D be odd, then*

$$\begin{aligned} & q^{(\deg N + \deg D - \frac{5}{2})s} (\Phi_s^{(o)*}(\pi_\infty^m, \lambda) - \widetilde{\Phi}_s^{(o)*}(\pi_\infty^m, \lambda)) = \\ & - \left[\frac{D}{N} \right] q^{(\deg N + \deg D - \frac{5}{2})(-s)} (\Phi_{-s}^{(o)*}(\pi_\infty^m, \lambda) - \widetilde{\Phi}_{-s}^{(o)*}(\pi_\infty^m, \lambda)), \end{aligned}$$

and therefore Lemma 2.7.1 implies that

$$Z(s) := q^{(\deg N + \deg D - \frac{5}{2})s} L^{(N, D)}(2s + 1) L(f, \mathcal{A}, s)$$

satisfies the functional equation

$$Z(s) = - \left[\frac{D}{N} \right] Z(-s).$$

PROOF. One can verify the functional equation for $\Phi_s^{(o)*}(\pi_\infty^m, \lambda) - \widetilde{\Phi}_s^{(o)*}(\pi_\infty^m, \lambda)$ independently for each summand (summation over $\mu \in \mathbb{F}_q[T]$) in the formula of Proposition 2.7.2 if one applies the following remarks:

a) For the first summand we mention (cf. [Ar]) that

$$L_D(s) := \frac{1}{q-1} \sum_{\substack{d \in \mathbb{F}_q[T] \\ d \neq 0}} \left[\frac{D}{d} \right] q^{-s \deg d} \tag{2.7.3}$$

is the L -series of the extension $K(\sqrt{D})/K$ and satisfies

$$L_D(2s + 1) = q^{s(-2 \deg D + 2) - \frac{1}{2} \deg D + \frac{1}{2}} L_D(-2s). \tag{2.7.4}$$

b) Let $\mu \in \mathbb{F}_q[T]$, $\mu \neq 0$ with $r_{\mathfrak{a}_0, \lambda_0}(\mu N - \lambda D) \neq 0$. Then there is $\kappa \in L$ with $N_{L/K}(\kappa) = \lambda_0(\mu N - \lambda D)$ (cf. (2.1.9)). Hence we get $\begin{bmatrix} D \\ \mu \end{bmatrix} = \begin{bmatrix} D \\ N \end{bmatrix} \delta_{\lambda_0 N \mu}$. This implies

$$\sum_{c|\mu} \begin{bmatrix} D \\ c \end{bmatrix} q^{-2s \deg c} = q^{-2s \deg \mu} \begin{bmatrix} D \\ N \end{bmatrix} \delta_{\lambda_0 N \mu} \sum_{c|\mu} \begin{bmatrix} D \\ c \end{bmatrix} q^{2s \deg c} \tag{2.7.5}$$

if $\mu \not\equiv 0 \pmod{D}$.

c) For $\mu \in \mathbb{F}_q[T]$ with $\mu \equiv 0 \pmod{D}$, it is easy to see that

$$\sum_{c|\mu} \begin{bmatrix} D \\ c \end{bmatrix} q^{-2s \deg c} = q^{-2s \deg \mu} \sum_{\substack{c|\mu \\ c \equiv 0 \pmod{D}}} \begin{bmatrix} D \\ \mu/c \end{bmatrix} q^{2s \deg c}. \quad \square \tag{2.7.6}$$

2.7.2 $\deg D$ IS EVEN

The automorphic cusp form f of Drinfeld type satisfies (cf. Definition 2.1.1)

$$\sum_{\beta \in GL_2(O_\infty)/\Gamma_\infty} f(X\beta) = 0 \text{ for all } X \in GL_2(K_\infty)/\Gamma_\infty K_\infty^*.$$

With this identity a transformation of the integral in Proposition 2.3.2 yields immediately:

LEMMA 2.7.4 *Let $\deg D$ be even, then*

$$\frac{1}{1 + q^{-s-1}} L^{(N,D)}(2s + 1) L(f, \mathcal{A}, s) = \frac{q}{2(q-1)} \int_{G(N)} f \cdot \overline{F_s^{(e)}}$$

with

$$F_s^{(e)}(X) := \frac{q}{q+1} \Phi_s^{(e)}(X) - \frac{1}{q+1} \sum_{\substack{\beta \in GL_2(O_\infty)/\Gamma_\infty \\ \beta \neq 1}} \Phi_s^{(e)}(X\beta),$$

whose Fourier coefficients are

$$F_s^{(e)*}(\pi_\infty^m, \lambda) = \begin{cases} \frac{q}{q+1} (\Phi_s^{(e)*}(\pi_\infty^m, \lambda) - \widetilde{\Phi_s^{(e)*}}(\pi_\infty^{m+1}, \lambda)), & \text{if } m \equiv \deg \lambda_0 \pmod{2} \\ 0 & \text{if } m \not\equiv \deg \lambda_0 \pmod{2} \end{cases}$$

and

$$\widetilde{F_s^{(e)*}}(\pi_\infty^m, \lambda) = \begin{cases} 0 & \text{if } m \equiv \deg \lambda_0 \pmod{2} \\ \frac{1}{q+1} (\widetilde{\Phi_s^{(e)*}}(\pi_\infty^m, \lambda) - \Phi_s^{(e)*}(\pi_\infty^{m-1}, \lambda)), & \text{if } m \not\equiv \deg \lambda_0 \pmod{2} \\ & \text{and } \deg \lambda + 2 < m \\ \widetilde{\Phi_s^{(e)*}}(\pi_\infty^m, \lambda) & \text{if } m \not\equiv \deg \lambda_0 \pmod{2} \\ & \text{and } \deg \lambda + 2 = m. \end{cases}$$

The calculations of $F_s^{(e)*}(\pi_\infty^m, \lambda)$ and $\widetilde{F}_s^{(e)*}(\pi_\infty^m, \lambda)$ are similar to those above and use Propositions 2.5.4, 2.6.2 and 2.6.4 developed in the previous sections. We only give the results.

PROPOSITION 2.7.5 *Let $\deg D$ be even, then*

$$\begin{aligned} & \Phi_s^{(e)*}(\pi_\infty^m, \lambda) - \widetilde{\Phi}_s^{(e)*}(\pi_\infty^{m+1}, \lambda) = r_{a_0, \lambda_0}(-\lambda D) q^{-m-\frac{1}{2} \deg D} . \\ & \left(\sum_{\substack{d \in \mathbb{F}_q[T] \\ d \neq 0}} \left[\frac{D}{d} \right] q^{-(2s+1) \deg d} \right) q^{-ms+2s+\frac{1}{2} \deg D} \\ & \quad + \left(\sum_{\substack{d \in \mathbb{F}_q[T] \\ d \neq 0}} \left[\frac{D}{d} \right] q^{-2s \deg d} \right) \left[\frac{D}{N} \right] q^{ms-2s \deg N+2s} \frac{-q^{1-s} - q^s}{q^s + q^{-s}} \\ & + \sum_{\substack{\mu \in \mathbb{F}_q[T], \mu \neq 0 \\ \deg(\mu N)+2 \leq m+\deg D}} r_{a_0, \lambda_0}(\mu N - \lambda D) q^{-m-\frac{1}{2} \deg D} . \\ & \left(\sum_{\substack{c|\mu \\ c \equiv 0 \pmod{D}}} \left[\frac{D}{\mu/c} \right] q^{-2s \deg c} \right) \left((-1)^{\deg(\lambda_0 N \mu)} q^{ms-2s \deg N+2s} \frac{-q^{1-s} - q^s}{q^s + q^{-s}} \right. \\ & \quad \left. + q^{-ms-2s \deg D+2s \deg \mu+4s} \frac{q^{-s} + q^{1+s}}{q^s + q^{-s}} \right) \\ & + \left(\sum_{c|\mu} \left[\frac{D}{c} \right] q^{-2s \deg c} \right) \left[\frac{D}{N} \right] \left(q^{ms-2s \deg N+2s} \frac{-q^{1-s} - q^s}{q^s + q^{-s}} \right. \\ & \quad \left. + (-1)^{\deg(\lambda_0 N \mu)} q^{-ms-2s \deg D+2s \deg \mu+4s} \frac{q^{-s} + q^{1+s}}{q^s + q^{-s}} \right), \end{aligned}$$

if $m \equiv \deg \lambda_0 \pmod{2}$, and

$$\begin{aligned} & \widetilde{\Phi}_s^{(e)*}(\pi_\infty^{\deg \lambda+2}, \lambda) = \sum_{\substack{\mu \in \mathbb{F}_q[T], \mu \neq 0 \\ \deg(\mu N) = \deg(\lambda D)}} r_{a_0, \lambda_0}(\mu N - \lambda D) q^{-\deg \lambda-1-\frac{1}{2} \deg D} . \\ & \left(- \left(\sum_{\substack{c|\mu \\ c \equiv 0 \pmod{D}}} \left[\frac{D}{\mu/c} \right] q^{-2s \deg c} \right) + \left[\frac{D}{N} \right] \left(\sum_{c|\mu} \left[\frac{D}{c} \right] q^{-2s \deg c} \right) \right) \\ & \quad \cdot q^{s \deg \lambda-2s \deg N+3s} \end{aligned}$$

if $\deg \lambda \not\equiv \deg \lambda_0 \pmod{2}$.

The proof of the following functional equation is completely analogous to the proof in the first case. Parts b) and c) in the proof of Theorem 2.7.3 are the same, part a) has to be replaced by the functional equation for $\deg D$ even

(cf. [Ar])

$$L_D(-2s+1) = \frac{1+q^{1-2s}}{1+q^{2s}} q^{\deg D(2s-\frac{1}{2})} L_D(2s). \quad (2.7.7)$$

We get

THEOREM 2.7.6 *Let $\deg D$ be even, then*

$$q^{(\deg N + \deg D - 3)s} (\Phi_s^{(e)*}(\pi_\infty^m, \lambda) - \widetilde{\Phi}_s^{(e)*}(\pi_\infty^{m+1}, \lambda)) = \\ - \left[\frac{D}{N} \right] q^{(\deg N + \deg D - 3)(-s)} (\Phi_{-s}^{(e)*}(\pi_\infty^m, \lambda) - \widetilde{\Phi}_{-s}^{(e)*}(\pi_\infty^{m+1}, \lambda)),$$

if $m \equiv \deg \lambda_0 \pmod{2}$, and therefore Lemma 2.7.4 implies that

$$Z(s) := q^{(\deg N + \deg D - 3)s} \frac{1}{1+q^{-s-1}} L^{(N,D)}(2s+1) L(f, \mathcal{A}, s)$$

satisfies the functional equation

$$Z(s) = - \left[\frac{D}{N} \right] Z(-s).$$

2.8 DERIVATIVES OF L -SERIES

The functional equations in Theorem 2.7.3 and Theorem 2.7.6 show that the L -series have a zero at $s = 0$, if $\left[\frac{D}{N} \right] = 1$. From now on we assume that $\left[\frac{D}{N} \right] = 1$, and we want to compute the derivatives of the L -series at $s = 0$.

2.8.1 $\deg D$ IS ODD

The first calculations are straightforward, we will only sketch this procedure. We start with the representation of $L^{(N,D)}(2s+1) L(f, \mathcal{A}, s)$ in Lemma 2.7.1, then we evaluate the derivatives $\frac{\partial}{\partial s} F_s^{(o)}|_{s=0}$ and $\frac{\partial}{\partial s} \widetilde{F}_s^{(o)}|_{s=0}$ from Proposition 2.7.2 by ordinary calculus. To simplify the formulas we introduce

$$t(\mu, D) := \begin{cases} 1 & , \text{ if } \mu \equiv 0 \pmod{D} \\ 0 & , \text{ if } \mu \not\equiv 0 \pmod{D} \end{cases}, \quad (2.8.1)$$

and we consider the function $L_D(s)$ defined in equation (2.7.3). It is known that

$$h_L := \#Cl(O_L) = L_D(0).$$

In addition we use equations (2.7.4), (2.7.5) and (2.7.6).

Then we apply the holomorphic projection formula of Proposition 2.4.1 and evaluate

$$\lim_{\sigma \rightarrow 0} \sum_{m=\deg \lambda + 2}^{\infty} q^{-m\sigma} \left(\frac{\partial}{\partial s} F_s^{(o)*}(\pi_{\infty}^m, \lambda) \Big|_{s=0} - \frac{\partial}{\partial s} \widetilde{F_s^{(o)*}}(\pi_{\infty}^m, \lambda) \Big|_{s=0} \right).$$

In Proposition 2.7.2 there is a summation over $\mu \in \mathbb{F}_q[T]$ with $\deg(\mu N) + 2 \leq m + \deg D$. We divide this summation into two parts. The first sum is over those μ with $\deg(\mu N) \leq \deg(\lambda D)$ and the second sum is over those μ with $\deg(\mu N) > \deg(\lambda D)$. This is done in view of the following lemma.

LEMMA 2.8.1 *Let $\mu \in \mathbb{F}_q[T]$, $\mu \neq 0$ with $r_{\mathfrak{a}_0, \lambda_0}(\mu N - \lambda D) \neq 0$, then*

a)

$$\frac{1 - \delta_{\lambda_0 N \mu}}{2} (t(\mu, D) - 1) \left(\sum_{c|\mu} \left[\frac{D}{c} \right] \right) = 0$$

and

b)

$$\delta_{\lambda_0 N \mu} = 1 \text{ if } \deg(\mu N) > \deg(\lambda D).$$

PROOF. The proof is an immediate consequence of $\left[\frac{D}{\mu} \right] = \left[\frac{D}{N} \right] \delta_{\lambda_0 N \mu}$, which was shown in the proof of Theorem 2.7.3, part b). □

Now at the end of our calculations we have to apply the trace corresponding to $\Gamma_0^{(1)}(N) \subset \Gamma_0(N)$ to get a cusp form of level N (and not just a cusp form for the subgroup $\Gamma_0^{(1)}(N)$). We recall that

$$\sum_{\epsilon \in \mathbb{F}_q^*} r_{\mathfrak{a}_0, \lambda_0}(\epsilon \mu) = (q - 1) r_{\mathcal{A}}((\mu)).$$

A heuristic consideration, based on the holomorphic projection formula of Proposition 2.4.1 and on our calculations, would then give:

$$\frac{\partial}{\partial s} (L^{(N, D)}(2s + 1) L(f, \mathcal{A}, s)) \Big|_{s=0} = \int_{\Gamma_0(N) \backslash GL_2(K_{\infty}) / \Gamma_{\infty} K_{\infty}^*} f \cdot \overline{\Psi_{\mathcal{A}}},$$

where $\Psi_{\mathcal{A}}$ is an automorphic cusp form of Drinfeld type of level N with

$$\begin{aligned} \Psi_{\mathcal{A}}^*(\pi_{\infty}^{\deg \lambda + 2}, \lambda) &= \frac{\ln q}{2} q^{-(\deg D + 1)/2} q^{-\deg \lambda} \\ &\cdot \left\{ (q - 1) r_{\mathcal{A}}((\lambda)) h_L \left(\deg N - \deg(\lambda D) - \frac{q + 1}{2(q - 1)} - \frac{2}{\ln q} \frac{L'_D(0)}{L_D(0)} \right) \right. \\ + \sum_{\substack{\mu \neq 0 \\ \deg(\mu N) \leq \deg(\lambda D)}} r_{\mathcal{A}}((\mu N - \lambda D)) &\left(\sum_{c|\mu} \left[\frac{D}{c} \right] \right) (t(\mu, D) + 1) \frac{1 + \delta_{(\mu N - \lambda D)\mu N}}{2} \cdot \\ &\cdot \left(\deg\left(\frac{\mu N}{\lambda D}\right) - \frac{q + 1}{2(q - 1)} \right) - (1 - \delta_{(\mu N - \lambda D)\mu N}) \left(\sum_{c|\mu} \left[\frac{D}{c} \right] \right) \deg \mu \\ &+ (1 - \delta_{(\mu N - \lambda D)\mu N}) (t(\mu, D) + 1) \left(\sum_{c|\mu} \left[\frac{D}{c} \right] \deg c \right) \\ - \frac{q + 1}{2(q - 1)} \lim_{\sigma \rightarrow 0} \sum_{\deg(\mu N) > \deg(\lambda D)} &r_{\mathcal{A}}((\mu N - \lambda D)) \left(\sum_{c|\mu} \left[\frac{D}{c} \right] \right) (t(\mu, D) + 1) \cdot \\ &\cdot q^{(-\sigma - 1) \deg(\frac{\mu N}{\lambda D})} \frac{(q - 1)^2 (q + q^{-\sigma})}{(q + 1)(q^{\sigma + 1} - 1)^2} q^{(-\sigma) \deg \lambda} \left. \right\}, \end{aligned} \tag{2.8.2}$$

provided the limit exists. But unfortunately this is not the case.

In order to get the final result, we proceed as follows:

- 1) We evaluate the pole of the limit in (2.8.2).
- 2) We find a function h on $\Gamma_0(N) \backslash GL_2(K_{\infty})/\Gamma_{\infty} K_{\infty}^*$, whose holomorphic projection formula gives the same pole part as in (2.8.2) and which is perpendicular to f under the Petersson product.
- 3) We replace $\frac{\partial}{\partial s} F_s^{(\sigma)}|_{s=0}$ by $\frac{\partial}{\partial s} F_s^{(\sigma)}|_{s=0} - h$ in the derivative of the equation in Lemma 2.7.1 and in our calculations.

We start with 1): From section 3.5.1 we get the following result (independently of these calculations):

Let $C_1 := 2(q - 1)^2/[GL_2(\mathbb{F}_q[T]) : \Gamma_0(N)]$, then the limit

$$\begin{aligned} \lim_{\sigma \rightarrow 0} \left(\sum_{\deg(\mu N) > \deg(\lambda D)} r_{\mathcal{A}}((\mu N - \lambda D)) \left(\sum_{c|\mu} \left[\frac{D}{c} \right] \right) (t(\mu, D) + 1) \right. \\ \left. \cdot q^{(-\sigma - 1) \deg(\frac{\mu N}{\lambda D})} - C_1 h_L \left(\sum_{a|\lambda} q^{\deg a} \right) \frac{1}{1 - q^{-\sigma}} \right) \end{aligned}$$

exists. But for this we have to adjust our assumptions. From now on N has to be square free with $\left[\frac{D}{P} \right] = 1$ for each prime divisor P of N and we only consider those λ with $\gcd(\lambda, N) = 1$.

We use this to calculate

$$\begin{aligned} & \lim_{\sigma \rightarrow 0} \left(\sum_{\deg(\mu N) > \deg(\lambda D)} r_{\mathcal{A}}((\mu N - \lambda D)) \left(\sum_{c|\mu} \left[\frac{D}{c} \right] \right) (t(\mu, D) + 1) q^{(-\sigma-1) \deg(\frac{\mu N}{\lambda D})} \right. \\ & \cdot \frac{(q-1)^2(q+q^{-\sigma})}{(q+1)(q^{\sigma+1}-1)^2} q^{(-\sigma) \deg \lambda} - C_1 h_L \left(\sum_{a|\lambda} q^{\deg a} \right) \frac{q^{(-\sigma)(\deg \lambda + 2)}}{1 - q^{-\sigma}} \Big) \\ & = \lim_{\sigma \rightarrow 0} \left(\sum_{\deg(\mu N) > \deg(\lambda D)} r_{\mathcal{A}}((\mu N - \lambda D)) \left(\sum_{c|\mu} \left[\frac{D}{c} \right] \right) (t(\mu, D) + 1) q^{(-\sigma-1) \deg(\frac{\mu N}{\lambda D})} \right. \\ & \quad \left. - C_1 h_L \left(\sum_{a|\lambda} q^{\deg a} \right) \frac{1}{1 - q^{-\sigma}} \right) + \left(\sum_{a|\lambda} q^{\deg a} \right) \cdot C_2, \end{aligned} \tag{2.8.3}$$

where C_2 is a certain constant.

2) To find the function h we introduce for $s > 1$:

$$g_{0,s} \left(\begin{pmatrix} \pi_{\infty}^m & u \\ 0 & 1 \end{pmatrix} \right) := -g_{0,s} \left(\begin{pmatrix} \pi_{\infty}^m & u \\ 0 & 1 \end{pmatrix} \begin{pmatrix} 0 & 1 \\ \pi_{\infty} & 0 \end{pmatrix} \right) := q^{-ms}$$

and the Eisenstein series

$$G_s(X) := \sum_M g_{0,s}(M \cdot X),$$

where the sum is taken over $M \in \begin{pmatrix} 1 & \mathbb{F}_q[T] \\ 0 & 1 \end{pmatrix} \backslash SL_2(\mathbb{F}_q[T])$. Then G_s is a function on $GL_2(K_{\infty})/\Gamma_{\infty} K_{\infty}^*$, which is invariant under $SL_2(\mathbb{F}_q[T])$ and which satisfies $\widetilde{G}_s = -G_s$. In addition G_s is perpendicular to cusp forms. This can be shown analogously to calculations in the proof of [Rü2], Proposition 14 (in fact G_s can be seen as a Poincaré series for $\mu = 0$).

We evaluate the Fourier coefficients of G_s in a straightforward way (cf. proof of [Rü2], Proposition 8) and get for $\deg \lambda + 2 \leq m, \lambda \neq 0$:

$$\begin{aligned} G_s^*(\pi_{\infty}^m, \lambda) &= \left(\sum_{a|\lambda} q^{-(2s-1) \deg a} \right) \\ & \cdot \left((1 - q^{2s}) q^{s(2 \deg \lambda - m) - \deg \lambda} + (q^s + 1)(q^{1-s} - 1) q^{s(m-2)+1-m} \right). \end{aligned}$$

The coefficients $G_s^*(\pi_{\infty}^m, 0)$ are not important, because they play no role in the holomorphic projection formula.

Now we define the Eisenstein series G by its Fourier coefficients

$$G^*(\pi_{\infty}^m, \lambda) := \lim_{s \rightarrow 1} G_s^*(\pi_{\infty}^m, \lambda),$$

and H by

$$H^*(\pi_{\infty}^m, \lambda) := \lim_{s \rightarrow 1} \frac{\partial}{\partial s} G_s^*(\pi_{\infty}^m, \lambda).$$

In the next step we evaluate the holomorphic projection formulas for G and H and we get

$$\lim_{\sigma \rightarrow 0} \sum_{m=\deg \lambda+2}^{\infty} q^{-m\sigma} (G^*(\pi_{\infty}^m, \lambda) - \tilde{G}^*(\pi_{\infty}^m, \lambda)) = -2(q+1) q^{-\deg \lambda-1} \left(\sum_{a|\lambda} q^{\deg a} \right), \quad (2.8.4)$$

and

$$\begin{aligned} \lim_{\sigma \rightarrow 0} \sum_{m=\deg \lambda+2}^{\infty} q^{-m\sigma} (H^*(\pi_{\infty}^m, \lambda) - \tilde{H}^*(\pi_{\infty}^m, \lambda)) &= -2(q+1) q^{-\deg \lambda-1} \ln q \\ &\cdot \left(- \left(\sum_{a|\lambda} q^{\deg a} (\deg \lambda - 2 \deg a) \right) + \left(\sum_{a|\lambda} q^{\deg a} \right) \lim_{\sigma \rightarrow 0} \frac{q^{(-\sigma)(\deg \lambda+2)}}{1 - q^{-\sigma}} \right. \\ &\quad \left. - \frac{1}{q+1} \left(\sum_{a|\lambda} q^{\deg a} \right) \right). \end{aligned} \quad (2.8.5)$$

This construction is motivated by the fact that the limit in the last formula already occurred in equation (2.8.3).

3) Comparing (2.8.4) and (2.8.5) with (2.8.2) and (2.8.3) shows how to choose $h = a \cdot G + b \cdot H$ with $a, b \in \mathbb{C}$ to get the final result:

THEOREM 2.8.2 *Let D be irreducible of odd degree, and let N be square free with $\left[\frac{D}{P} \right] = 1$ for each prime divisor P of N . For a newform f of level N we get:*

$$\frac{\partial}{\partial s} (L^{(N,D)}(2s+1)L(f, \mathcal{A}, s)) \Big|_{s=0} = \int_{\Gamma_0(N) \backslash GL_2(K_{\infty}) / \Gamma_{\infty} K_{\infty}^*} f \cdot \overline{\Psi_{\mathcal{A}}},$$

where $\Psi_{\mathcal{A}}$ is a cusp form of level N , whose Fourier coefficients for λ with $\gcd(\lambda, N) = 1$ are given by

$$\begin{aligned} & \Psi_{\mathcal{A}}^*(\pi_{\infty}^{\deg \lambda + 2}, \lambda) = \frac{\ln q}{2} q^{-(\deg D + 1)/2} q^{-\deg \lambda} \\ & \cdot \left\{ (q-1) r_{\mathcal{A}}((\lambda)) h_L \left(\deg N - \deg(\lambda D) - \frac{q+1}{2(q-1)} - \frac{2}{\ln q} \frac{L'_D(0)}{L_D(0)} \right) \right. \\ + & \sum_{\substack{\mu \neq 0 \\ \deg(\mu N) \leq \deg(\lambda D)}} r_{\mathcal{A}}((\mu N - \lambda D)) \left(\sum_{c|\mu} \left[\frac{D}{c} \right] \right) (t(\mu, D) + 1) \frac{1 + \delta_{(\mu N - \lambda D)\mu N}}{2} \\ & \cdot \left(\deg\left(\frac{\mu N}{\lambda D}\right) - \frac{q+1}{2(q-1)} \right) - (1 - \delta_{(\mu N - \lambda D)\mu N}) \left(\sum_{c|\mu} \left[\frac{D}{c} \right] \right) \deg \mu \\ & \quad + (1 - \delta_{(\mu N - \lambda D)\mu N}) (t(\mu, D) + 1) \left(\sum_{c|\mu} \left[\frac{D}{c} \right] \deg c \right) \\ - & \frac{q+1}{2(q-1)} \lim_{s \rightarrow 0} \left(\sum_{\deg(\mu N) > \deg(\lambda D)} r_{\mathcal{A}}((\mu N - \lambda D)) \left(\sum_{c|\mu} \left[\frac{D}{c} \right] \right) (t(\mu, D) + 1) \right. \\ & \quad \cdot q^{(-s-1) \deg(\frac{\mu N}{\lambda D})} - \frac{C_1 h_L(\sum_{a|\lambda} q^{\deg a})}{1 - q^{-s}} \Big) \\ & \left. - \frac{q+1}{2(q-1)} C_1 h_L \left(\sum_{a|\lambda} q^{\deg a} (\deg \lambda - 2 \deg a) \right) + \left(\sum_{a|\lambda} q^{\deg a} \right) C_2 \right\}. \end{aligned}$$

The following notation is used: $h_L = \#Cl(O_L)$, $L_D(s)$ is as in (2.7.3), $t(\mu, D)$ is as in (2.8.1),

$$C_1 = 2(q-1)^2 / [GL_2(\mathbb{F}_q[T]) : \Gamma_0(N)],$$

and C_2 is any constant (in particular independent of λ).

2.8.2 $\deg D$ IS EVEN

Of course the programme is the same as above. We start with Lemma 2.7.4, and we get the same pole as in (2.8.2) with different constants. Here we use the result (cf. section 3.5.2):

Let $C_1 := (q^2 - 1)^2 / (2q [GL_2(\mathbb{F}_q[T]) : \Gamma_0(N)])$, then the limit

$$\begin{aligned} & \lim_{\sigma \rightarrow 0} \left(\sum_{\deg(\mu N) > \deg(\lambda D)} r_{\mathcal{A}}((\mu N - \lambda D)) \left(\sum_{c|\mu} \left[\frac{D}{c} \right] \right) (t(\mu, D) + 1) \right. \\ & \quad \cdot q^{(-\sigma-1) \deg(\frac{\mu N}{\lambda D})} - C_1 h_L \left(\sum_{a|\lambda} q^{\deg a} \right) \frac{1}{1 - q^{-\sigma}} \Big) \end{aligned}$$

converges.

Again we take the Eisenstein series G and H to get the final result:

THEOREM 2.8.3 *Let D be irreducible of even degree, and let N be square free with $\left[\frac{D}{P}\right] = 1$ for each prime divisor P of N . For a newform f of level N we get:*

$$\frac{\partial}{\partial s} \left(\frac{1}{1+q^{-s-1}} L^{(N,D)}(2s+1)L(f, \mathcal{A}, s) \right) |_{s=0} = \int_{\Gamma_0(N) \backslash GL_2(K_\infty) / \Gamma_\infty K_\infty^*} f \cdot \overline{\Psi_{\mathcal{A}}},$$

where $\Psi_{\mathcal{A}}$ is a cusp form of level N , whose Fourier coefficients for λ with $\gcd(\lambda, N) = 1$ are given by

$$\begin{aligned} & \Psi_{\mathcal{A}}^*(\pi_\infty^{\deg \lambda + 2}, \lambda) = \frac{\ln q}{4} q^{-\deg D/2} q^{-\deg \lambda} \\ & \cdot \left\{ r_{\mathcal{A}}((\lambda)) h_L(q-1) \left(\deg N - \deg(\lambda D) - \frac{2q}{q^2-1} - \frac{2}{\ln q} \frac{L'_D(0)}{L_D(0)} \right) \right. \\ + & \sum_{\substack{\mu \neq 0 \\ \deg(\mu N) \leq \deg(\lambda D)}} r_{\mathcal{A}}((\mu N - \lambda D)) \left(\sum_{c|\mu} \left[\frac{D}{c} \right] \right) (t(\mu, D) + 1) \frac{1 + \delta_{(\mu N - \lambda D)\mu N}}{2} \\ & \cdot \left(\deg\left(\frac{\mu N}{\lambda D}\right) - \frac{2q}{q^2-1} \right) - (1 - \delta_{(\mu N - \lambda D)\mu N}) \left(\sum_{c|\mu} \left[\frac{D}{c} \right] \right) \deg \mu \\ & \quad + (1 - \delta_{(\mu N - \lambda D)\mu N}) (t(\mu, D) + 1) \left(\sum_{c|\mu} \left[\frac{D}{c} \right] \deg c \right) \\ - & \frac{2q}{q^2-1} \lim_{s \rightarrow 0} \left(\sum_{\deg(\mu N) > \deg(\lambda D)} r_{\mathcal{A}}((\mu N - \lambda D)) \left(\sum_{c|\mu} \left[\frac{D}{c} \right] \right) (t(\mu, D) + 1) \right. \\ & \quad \cdot q^{(-s-1)\deg(\frac{\mu N}{\lambda D})} - C_1 h_L \left(\sum_{a|\lambda} q^{\deg a} \frac{1}{1-q^{-s}} \right) \\ & \quad \left. - \frac{2q}{q^2-1} C_1 h_L \left(\sum_{a|\lambda} q^{\deg a} (\deg \lambda - 2 \deg a) \right) + \left(\sum_{a|\lambda} q^{\deg a} \right) C_2 \right\}. \end{aligned}$$

The following notation is used: $h_L = \#Cl(O_L)$, $L_D(s)$ is as in (2.7.3), $t(\mu, D)$ is as in (2.8.1),

$$C_1 = (q^2 - 1)^2 / (2q [GL_2(\mathbb{F}_q[T]) : \Gamma_0(N)]),$$

and C_2 is any constant (in particular independent of λ).

3 HEIGHTS OF HEEGNER POINTS

3.1 HEEGNER POINTS

Let $K = \mathbb{F}_q(T)$ be the rational function field over \mathbb{F}_q as in the previous chapters. For every $N \in \mathbb{F}_q[T]$ there exists a coarse moduli scheme $Y_0(N)$ over $\mathbb{F}_q[T]$ parametrizing isomorphism classes of pairs (ϕ, ϕ') of Drinfeld modules of rank 2 together with a cyclic isogeny $u : \phi \rightarrow \phi'$ of degree N (cf. Lecture 2, [AB]). This means that $\ker u \simeq \mathbb{F}_q[T]/(N)$. $Y_0(N)$ can be compactified to a scheme $X_0(N)$ by adjoining a finite number of sections. The points on these sections can be interpreted as generalized Drinfeld modules (cf. Lecture 9 [AB]). The fibres of $X_0(N) \rightarrow \text{Spec } \mathbb{F}_q[T]$ are regular outside the divisors of N . We will also need the structure of the fibres over such places, which are known only for N square free. So we will assume this condition on N for the whole chapter. By abuse of notation we often write $X_0(N)$ also for the generic fibre $X_0(N) \otimes K$. For every $\lambda \in \mathbb{F}_q[T]$ there is a Hecke correspondence on $X_0(N)$. If $x \in X_0(N)$ is represented by two Drinfeld modules ϕ, ϕ' and a cyclic isogeny $u : \phi \rightarrow \phi'$, in which case we write $x = (\phi, \phi', u)$, then $T_\lambda(x) = \sum_C(x_C)$, where C runs over all cyclic $\mathbb{F}_q[T]$ submodules of ϕ isomorphic to $\mathbb{F}_q[T]/(\lambda)$ which intersect $\ker u$ trivially. x_C is the point corresponding to $(\phi/C \rightarrow \phi'/u(C))$. The Hecke algebra is the subalgebra of $\text{End } J_0(N)$, the endomorphisms of the Jacobian of $X_0(N)$, generated by the endomorphisms induced by the Hecke correspondences. For more details see for example [Ge3].

Now let $L = K(\sqrt{D})$ be an imaginary quadratic extension, where D is a polynomial in $\mathbb{F}_q[T]$. In the first part of this section we prove results for general D , later we specialize to D being irreducible. We choose $N \in \mathbb{F}_q[T]$ such that each of its prime divisors is split in L . Then in particular we have $\left[\frac{D}{N}\right] = 1$. Suppose that ϕ, ϕ' are two Drinfeld modules of rank 2 for the ring $\mathbb{F}_q[T]$ with complex multiplication by an order $O \subset O_L = \mathbb{F}_q[T][\sqrt{D}]$, i.e. $\text{End } \phi = \text{End } \phi' = O$ and that $u : \phi \rightarrow \phi'$ is a cyclic isogeny of degree N . Then ϕ and ϕ' can be viewed as rank 1 Drinfeld modules over O . As explained in the paper ([Ha]) there is a natural action on rank 1 Drinfeld modules: If $\mathfrak{n} \subset O$ is an invertible ideal and ϕ is a rank 1 Drinfeld module then there is a Drinfeld module $\mathfrak{n} * \phi$ with an isogeny $\phi_{\mathfrak{n}} : \phi \rightarrow \mathfrak{n} * \phi$. As was remarked in ([Ha]) just before Proposition 8.3, every isogeny is of this form up to isomorphism. The explicit class field theory ([Ha]) shows that ϕ, ϕ' and the isogeny u can be defined (modulo isomorphisms) over the class field H_O of O , which is unramified outside the conductor $\mathfrak{f} := \{\alpha \in L : \alpha O_L \subset O\}$ of O and where ∞ is totally split. (For the maximal order O_L we will simply write H instead of H_{O_L} .) Therefore the triple (ϕ, ϕ', u) defines an H_O -rational point x on $X_0(N)$. This holds even though $X_0(N)$ is not a fine moduli space. These rational points x are called *Heegner points*. We will primarily consider Heegner points for the maximal order O_L but Heegner points corresponding to non-maximal orders will occur naturally, when we consider the operation of Hecke operators on the Heegner points.

Heegner points corresponding to a maximal order can also be described by the following data: Let K_∞ be the completion of K at ∞ and let C_∞ be the completion of the algebraic closure of K_∞ . The category of Drinfeld modules of rank 2 over C_∞ is equivalent to the category of rank 2 lattices in C_∞ . If ϕ, ϕ' correspond to lattices Λ, Λ' , the isogenies are described by $\{c \in C_\infty^* : c\Lambda \subset \Lambda'\}$. If ϕ has complex multiplication by O_L , the corresponding lattice is isomorphic to an ideal \mathfrak{a} in O_L . Now let $\mathfrak{n}|N$ be an ideal of O_L which contains exactly one prime divisor of every conjugated pair over the primes dividing N . If $\mathfrak{n}|\mathfrak{a}$, the ideal $\mathfrak{n}^{-1}\mathfrak{a}$ is integral and corresponds to another Drinfeld module ϕ' with complex multiplication. The inclusion $\mathfrak{a} \subset \mathfrak{n}^{-1}\mathfrak{a}$ defines a cyclic isogeny of degree N , because $\mathfrak{n}^{-1}\mathfrak{a}/\mathfrak{a} \simeq O_L/\mathfrak{n} \simeq \mathbb{F}_q[T]/(N)$.

The data describing the Heegner point x is the ideal class of \mathfrak{a} and the ideal \mathfrak{n} . We get the following analytic realization of the Heegner point x .

Let $\Omega = C_\infty - K_\infty$ be the Drinfeld upper half plane. Then $X_0(N)$ is analytically given by the quotient $\Gamma_0(N) \backslash \Omega$ compactified by adjoining finitely many cusps. Let $z \in \Omega$ with

$$z = \frac{B + \sqrt{D}}{2A}, \quad N|A, \quad B^2 \equiv D \pmod{A}.$$

Then the lattice $\langle z, 1 \rangle$ is isomorphic to the ideal $\mathfrak{a} = A\mathbb{F}_q[T] + (B + \sqrt{D})\mathbb{F}_q[T]$, which defines together with the ideal $\mathfrak{n} = N\mathbb{F}_q[T] + (\beta + \sqrt{D})\mathbb{F}_q[T]$ with $\beta \equiv B \pmod{N}$ a Heegner point.

Now we consider the global Néron-Tate height pairing on the H -rational points of the Jacobian $J_0(N)$ of $X_0(N)$. There is an embedding of $J_0(N)$ in the projective space \mathbb{P}^{2g-1} (Kummer embedding), where g is the genus of $X_0(N)$. The naive height on points in the projective space defines a height function h on $J_0(N)(H)$. The Néron-Tate height is the unique function \hat{h} , which differs from h by a bounded function and such that the map $\langle \cdot \rangle : J_0(N) \times J_0(N) \rightarrow \mathbb{R}$ defined by $\langle D, E \rangle = (1/2)(\hat{h}(D + E) - \hat{h}(D) - \hat{h}(E))$ is bilinear. $\langle \cdot \rangle$ is called the Néron-Tate height pairing (cf. [Gr1]). The pairing depends on H although we omit this in the notation. Whenever we consider height pairings over other fields than H , it will be explicitly mentioned.

The global pairing can be written as a sum $\sum_v \langle \cdot \rangle_v$ running over all places v of H . For an irreducible polynomial $P \in \mathbb{F}_q[T]$ we write $\langle \cdot \rangle_P$ for $\sum_{v|P} \langle \cdot \rangle_v$. For the definition of the local pairing see [Gr1, 2.5]. We recall the relation of the local pairing at non-archimedean primes with the intersection product on a regular model (see [Gr1, 3]). Let v be some place of H and let H_v be the completion with valuation ring O_v . We write q_v for the cardinality of the residue field. Let X/H_v be a curve and \mathcal{X}/O_v be a regular model of X . Suppose D, E are divisors of degree 0 on $X_0(N)$ with disjoint support. Let \mathcal{F}_i be the fibre components of the special fibre of the regular model \mathcal{X} and let \tilde{D}, \tilde{E} be the horizontal divisors to D, E . (The horizontal divisor of a point in the generic fibre is just the Zariski closure of it in \mathcal{X} .) Let $(\cdot)_v$ be the intersection product on \mathcal{X} , which is defined in the following way. Let $x \neq y$ be two distinct points on X and \tilde{x}, \tilde{y} their closure in \mathcal{X} . For a point z in the special fibre we consider

the stalk $O_{\mathcal{X},z}$ of the structure sheaf in z . Let f_x, f_y be local equations for \tilde{x}, \tilde{y} in z . Then $O_{\mathcal{X},z}/(f_x, f_y)$ is a module of finite length. The intersection number $(\tilde{x} \cdot \tilde{y})_{v,z}$ is defined to be the length of the module $O_{\mathcal{X},z}/(f_x, f_y)$ and it is zero for almost all z . Let $\deg z$ be the degree of the residue field in z over the residue field of v . The intersection number is then $(\tilde{x} \cdot \tilde{y})_v = \sum_z (\tilde{x} \cdot \tilde{y})_{v,z} \cdot \deg z$. Now return to the divisors D, E of degree 0. There exist $\alpha_i \in \mathbb{Q}$ such that

$$\langle D, E \rangle_v = -\ln q_v [(\tilde{D} \cdot \tilde{E})_v + \sum_i \alpha_i (\mathcal{F}_i \cdot \tilde{E})_v] \tag{3.1.1}$$

cf. [Gr1, 3]. The elements α_i are unique up to an additive constant, independent of i . In particular if $(\tilde{D} \cdot \mathcal{F}_i)_v = 0$ for all i , the equation (3.1.1) is satisfied with $\alpha_i = 0$ for all i .

Let $x = (\phi, \phi', u)$ be a Heegner point on $X_0(N)$ for the maximal order O_L . We denote by $\sigma_{\mathcal{A}}$ the element in the Galois group of H/L which corresponds via class field theory to $\mathcal{A} \in Cl(O_L)$. Then $x^{\sigma_{\mathcal{A}}}$ is again a Heegner point for the maximal order. The cusps are given by the cosets $\Gamma_0(N) \backslash \mathbb{P}^1(K)$ and they are K -rational. If $\deg N > 0$ we have at least the two different cusps 0 and ∞ . We get the divisors $(x) - (\infty)$ and $(x)^{\sigma_{\mathcal{A}}} - (0)$ of degree 0 on $X_0(N)$.

Let T_λ be a Hecke operator and let g be an automorphic cusp form of Drinfeld type of level N (cf. Definition (2.1.1)). If we associate to (T_λ, g) the Fourier coefficient $(T_\lambda g)^*(\pi_\infty^2, 1)$, we get a bilinear map between the Hecke algebra and the space of cusp forms of level N . This map is a non-degenerate pairing ([Ge3, Thm. 3.17]). For $\gcd(\lambda, N) = 1$ we have

$$(T_\lambda g)^*(\pi_\infty^2, 1) = q^{\deg \lambda} g^*(\pi_\infty^{\deg \lambda + 2}, \lambda).$$

This is the key to the proof of the following proposition as in [Gr-Za, V 1]

PROPOSITION 3.1.1 *There is an automorphic cusp form $g_{\mathcal{A}}$ of Drinfeld type of level N such that*

$$\langle (x) - (\infty), T_\lambda((x)^{\sigma_{\mathcal{A}}} - (0)) \rangle = q^{\deg \lambda} g_{\mathcal{A}}^*(\pi_\infty^{\deg \lambda + 2}, \lambda)$$

for all $\lambda \in \mathbb{F}_q[T]$ with $\gcd(\lambda, N) = 1$.

We want to compare $g_{\mathcal{A}}$ with the cusp form $\Psi_{\mathcal{A}}$ of the previous section. Therefore we have to evaluate this global height pairing. As we compare the cusp forms only up to old forms, it suffices to calculate the height pairings above only for the Hecke operators with $\gcd(\lambda, N) = 1$. Thus we restrict to this case in the whole section.

The first objective of this section is to express the intersection number of the Heegner divisors on $X_0(N)$ at the finite places, i.e., those places corresponding to irreducible polynomials in $\mathbb{F}_q[T]$, by numbers of homomorphisms between the corresponding Drinfeld modules (Theorem 3.3.4).

For a place v of H we write H_v for the completion at v and O_v for the valuation ring. Let W be the completion of the maximal unramified extension of O_v and

π a uniformizing element of O_v (W , resp.). In order to calculate the local pairings

$$\langle (x) - (\infty), T_\lambda((x)^{\sigma_A} - (0)) \rangle_v$$

we first describe the divisor $T_\lambda x^{\sigma_A}$.

3.2 THE DIVISOR $T_\lambda x^{\sigma_A}$

DEFINITION 3.2.1 *If $x = (\phi, \phi', u)$ and $y = (\psi, \psi', v)$ are two points on $X_0(N)$, where ϕ, ϕ', ψ, ψ' are Drinfeld modules of rank 2 and $u : \phi \rightarrow \phi'$ and $v : \psi \rightarrow \psi'$ are cyclic isogenies of degree N , we define*

$$\text{Hom}_R(x, y) := \{(f, f') \in \text{Hom}_R(\phi, \psi) \times \text{Hom}_R(\phi', \psi') : vf = f'u\}$$

for any ring R where this is well defined, e.g. for R a local ring with algebraically closed residue field.

Consider a finite place v of H . Let H_v be the completion of H at v and let O_v be the valuation ring. Let W again be the completion of the maximal unramified extension of O_v .

LEMMA 3.2.2 *Let $x = (\phi, \phi', \phi_n)$ be a Heegner point for the maximal order and \mathfrak{a} an integral ideal in the class \mathcal{A} , which corresponds to $\sigma_{\mathcal{A}} \in \text{Gal}(H/L)$ under the Artin homomorphism. Then*

$$\text{Hom}_W(x^{\sigma_{\mathcal{A}}}, x) \simeq \text{End}_W(x) \cdot \mathfrak{a} \tag{3.2.1}$$

and

$$\text{Hom}_{W/\pi^n}(x^{\sigma_{\mathcal{A}}}, x) \simeq \text{End}_{W/\pi^n}(x) \cdot \mathfrak{a} \tag{3.2.2}$$

for every $n \geq 1$ as left modules over the prevailing ring of endomorphisms.

PROOF. It is enough to show the second assertion for all n , because for n sufficiently big the second and the first assertion coincide. We show the assertion for ϕ instead of x . To show it for x one only has to remark that the morphism defined below is compatible with the morphism ϕ_n . We again assume that ϕ is defined over W and has leading coefficients in $\overline{\mathbb{F}_q}^*$. For brevity we write $R_n := \text{End}_{W/\pi^n}(\phi)$. Let Λ be the fraction field of W and $I_{\mathfrak{a}}$ be the left ideal in $\Lambda\{\tau\}$ generated by all ϕ_a with $a \in \mathfrak{a}$. This ideal is left principal and generated by some $\phi_{\mathfrak{a}} \in W\{\tau\}$ ([Ha], Prop. 7.5). So $I_{\mathfrak{a}} \cap R_n$ is a left ideal in R_n and we shall show that it is equal to the left ideal $R_n \mathfrak{a}$. The inclusion $R_n \mathfrak{a} \subset I_{\mathfrak{a}} \cap R_n$ is trivial. For the other inclusion we shall show $(I_{\mathfrak{a}} \cap R_n) \mathfrak{a}^{-1} \subset R_n$. Without loss of generality we shall assume that the image under the natural inclusion of \mathfrak{a} is not divisible by π . Then for every $b \in \mathfrak{a}^{-1}$ there is a twisted power series ϕ_b in $W\{\{\tau\}\}$ such that for $a \in \mathfrak{a}$ we get $\phi_a \phi_b = \phi_{ab}$. Now let $f \in I_{\mathfrak{a}} \cap R_n$ and $b \in \mathfrak{a}^{-1}$, then $f = \sum f_i \phi_{a_i}$, for some $f_i \in W\{\tau\}$. So $f \phi_b = \sum f_i \phi_{a_i b}$, which is

a polynomial, because $a_i b \in O$. We also have $\phi_b \phi_a = \phi_a \phi_b$ for every $a \in \mathbb{F}_q[T]$, and therefore $f \phi_b \phi_a \equiv \phi_a f \phi_b \pmod{\pi^n}$. This implies $f \cdot b \in R_n$. We know from (Thm. 8.5[Ha]) that there exists a $w \in W^*$ such that

$$\phi_a \phi_a = w^{-1} \phi_a^{\sigma_A} w \phi_a$$

holds for every $a \in O$, i.e. $w \phi_a \in \text{Hom}_W(\phi, \phi^\sigma)$. Now define an R_n -module homomorphism from $\text{Hom}_{W/\pi^n}(\phi^{\sigma_A}, \phi)$ to $R_n \cap I_a$ by the assignment $f \mapsto f \cdot w \phi_a$. On the other hand if $g \in W/\pi^n\{\tau\}$ such that $g w \phi_a =: u \in R_n$, then we have to show that $g \in \text{Hom}_{W/\pi^n}(\phi^\sigma, \phi)$. We have

$$g \phi_a^\sigma w \phi_a = g w \phi_a \phi_a = u \phi_a = \phi_a u$$

for all $a \in \mathbb{F}_q[T]$, where the last equality holds, because $\mathbb{F}_q[T]$ is central in R_1 and therefore also in R_n for every $n \geq 1$. But $\phi_a u = \phi_a g w \phi_a$ and so

$$(g \phi_a^\sigma - \phi_a g) w \phi_a = 0.$$

$w \phi_a$ cannot be a zero divisor, because the leading coefficient of ϕ_a is 1. This finishes the proof of the lemma. \square

From this lemma we get the following result about the multiplicity of x in $T_\lambda x^{\sigma_A}$. The proof is exactly the same as in the characteristic 0 case ([Gr-Za, (4.3)]).

PROPOSITION 3.2.3 *Let $\sigma_A \in \text{Gal}(H/L)$, let \mathcal{A} be the ideal class corresponding to σ_A and let $\lambda \in \mathbb{F}_q[T]$. Then the multiplicity of x in the divisor $T_\lambda x^{\sigma_A}$ is equal to the number $r_{\mathcal{A}}(\lambda)$ of integral ideals in the class of \mathcal{A} with norm (λ) .*

The points $y \in T_\lambda x^{\sigma_A}$ are Heegner points for orders $O_y \subset O_L$. Let $\mathfrak{f} = \{\alpha \in L : \alpha O_L \subset O_y\}$ be the conductor of the order O_y . Let P be an irreducible, monic polynomial in $\mathbb{F}_q[T]$ and let $s = s(y, P)$ be the greatest integer with $P^s | \mathfrak{f}$. We call s the level of y at P . If $P \nmid \lambda$, we get $s = 0$, because $\mathfrak{f} | (\lambda)$. If $\lambda = P^t \cdot R$ with $P \nmid R$ and $t > 0$, then

$$T_\lambda x^{\sigma_A} = \sum_{z \in T_R x^{\sigma_A}} T_{P^t} z.$$

The following proposition tells us how often each level occurs in the divisor $T_{P^t} z$. For a proof see [Til].

PROPOSITION 3.2.4 *Let $P \in \mathbb{F}_q[T]$ be irreducible and let z be a Heegner point of level 0 at P . Set $d = \deg P$ and $q_P = q^d$. Then the number of points of level s in the divisor $T_{P^t} z$ is equal to*

$$\left. \begin{array}{l} (t-s+1)(q_P^s - q_P^{s-1}) \text{ for } t \geq s \geq 1 \\ t+1 \text{ for } s = 0 \end{array} \right\} \text{ if } P \text{ is split in } L/K;$$

$$\left. \begin{array}{l} q_P^s + q_P^{s-1} \text{ for } t \geq s \geq 1, s \equiv t \pmod{2} \\ 1 \text{ for } s = 0, t \equiv 0 \pmod{2} \end{array} \right\} \text{ if } P \text{ is inert in } L/K;$$

$$q_P^s \text{ for } t \geq s \geq 0 \text{ if } P \text{ is ramified in } L/K.$$

The next proposition shows where the points with level s are defined. The proof is given by D. Hayes ([Ha, Thm 8.10, Thm. 1.5])

PROPOSITION 3.2.5 *Let P be any irreducible polynomial and let z be a Heegner point for an order O with conductor prime to N . Suppose that z has level 0 at P . Then*

1. z is defined over H_O , the ring class field of O , which is unramified over H at P . The Galois group of H_O/H is isomorphic to the group of ideals in O_L modulo the principal ideals generated by some element $a \in O$ which is prime to the conductor of O .
2. Every $y \in T_{P^t}z$ of level s at P is defined over another class field H_s with $[H_s : H_O] = |(O_L/P^s O_L)^*|/|(\mathbb{F}_q[T]/P^s \mathbb{F}_q[T])^*|$, which is totally ramified at P over H_O .

3.3 THE FINITE PLACES

For the calculations of height pairings at the finite places we want to make use of the modular interpretation of the points on the modular curve in every fibre including the fibres over the divisors of N . In contrast to the elliptic curve case, we do not know how these fibres look like if N is not square free. This is one reason why we confine ourselves to this case.

The first step is to describe the pairings at a finite place v by intersection products on a regular model of $X_0(N) \otimes K$. When $v \nmid N$ then $X_0(N) \otimes O_v$ is a regular model and when $v|N$ we take a regularization of $X_0(N) \otimes O_v$, which can be done by finitely many blow ups at the singular points. After that we use the modular interpretation to describe the intersection numbers by numbers of homomorphisms.

First we recall the structure of the fibres of $X_0(N)$ at the places over N (see [Ge2]).

PROPOSITION 3.3.1 *For $N \in \mathbb{F}_q[T]$ square free, $N \notin \mathbb{F}_q$, the modular curve $X_0(N)$ over $\mathbb{F}_q[T]$ is regular outside N and outside the supersingular points in the fibres above prime divisors of N . Let P be any prime divisor of N of degree d . Then the special fibre over P consists of two copies of $X_0(N/P)$, which intersect transversally in the supersingular points. One of the components is the image of the map*

$$\begin{aligned} X_0(N/P) \times \mathbb{F}_q[T]/P &\longrightarrow X_0(N) \times \mathbb{F}_q[T]/P \\ (\phi, \phi', u) \bmod P &\longmapsto (\phi, \phi'', \tau^d u) \bmod P, \end{aligned}$$

where τ^d is the Frobenius of $\mathbb{F}_q[T]/P$ regarded as isogeny of degree P . This component is the “local component”, the other one is the “reduced component”. The cusp 0 lies on the reduced component and ∞ lies on the local component.

REMARKS. 1. We need not know what the resolutions of singular points are, because our horizontal divisors always intersect the fibres over N outside the supersingular points and the next proposition will show that no contribution from the fibre components of the regular model will occur.

2. Because $\gcd(D, N) = 1$, the regular model remains regular under base change to the Hilbert class field H/L as well as over the completion of the maximal unramified extension W of some completion O_v for a place v of H .

PROPOSITION 3.3.2 *Let $x = (\phi, \phi', \phi_n)$ be a Heegner point for the maximal order, $\sigma_A \in \text{Gal}(H/L)$, A the corresponding ideal class, $\lambda \in \mathbb{F}_q[T]$, v a finite place of H of residue cardinality q_v . Suppose that $r_A((\lambda)) = 0$, then*

$$((x) - (\infty), T_\lambda((x)^{\sigma_A} - (0)))_v = -(x \cdot T_\lambda x^{\sigma_A})_v \ln q_v.$$

PROOF. At first we check that the horizontal extension of one of the divisors in the pairing has zero intersection with both fibre components if $v|N$. It follows that the values α_i in 3.1.1 all vanish. Let \mathfrak{n} be the ideal, such that ϕ_n is the cyclic isogeny defining x . If $v|\mathfrak{n}$, x intersects the fibre in the local component. If $v \nmid \mathfrak{n}$ then it intersects in the reduced component. Thus one of the divisors $(x) - (\infty), (x) - (0)$ has zero intersection with both fibre components. But the points in $T_\lambda x^{\sigma_A}$ reduce to the same component as x . This shows that one of the divisors has zero intersection with all fibre components. This is trivially true for the places of good reduction ($v \nmid N$). The result now follows by linearity of the pairing and the fact that x can be represented by a Drinfeld module with good reduction, so it does not intersect with the cusps. \square

PROPOSITION 3.3.3 *Let $x = (\phi \rightarrow \phi')$, $y = (\psi \rightarrow \psi')$ be two W -rational sections, i.e. horizontal divisors on $X_0(N)$ over W , which intersect properly and which reduce to regular points outside the cusps in the special fibre. Then*

$$(y \cdot x)_v = \frac{1}{q-1} \sum_{n \geq 1} \# \text{Isom}_{W/\pi^n}(y, x).$$

PROOF. Let $f : Y \rightarrow X_0(N)$ be a fine moduli scheme (e.g. a supplementary full level N' -structure with $\gcd(N', N) = 1$ and N' with at least two different prime factors.) Let y_0 be a pre-image of y and x_i the different pre-images of x , i.e. $f_*(y_0) = y$, $f^*(x) = \sum x_i$. Because f is proper, the projection formula [Sha, Lect.6,(7)] implies that

$$(y \cdot x)_v = (f_* y_0 \cdot x)_v = (y_0 \cdot f^* x)_v = \sum_i (y_0 \cdot x_i)_v.$$

If (ϕ, ϕ', u) is a representative of x , all the x_i are represented by (ϕ, ϕ', u, P, Q) , where P, Q generates the N' torsion module. Every such point occurs with multiplicity $\#\text{Aut}(x)/(q-1)$ in $f^*(x)$. The $q-1$ trivial automorphisms all give the same point in $f^*(x)$. Now let (ψ, ψ', v) be a representative of y and (ϕ, ϕ', u) a representative of x . Let y_0 be represented by (ψ, ψ', v, P, Q) .

Then an isomorphism $f : (\psi, \psi', v) \rightarrow (\phi, \phi', u)$ defines an isomorphism $\hat{f} : (\psi, \psi', v, P, Q) \rightarrow (\phi, \phi', u, f(P), f(Q))$ and this is uniquely determined. If x_{i_0} is the class of $(\phi, \phi', u, f(P), f(Q))$, we have

$$\#\text{Isom}_{W/\pi^n}(y_0, x_i) = \begin{cases} 1 & , \text{ if } x_i = x_{i_0} \\ 0 & , \text{ otherwise.} \end{cases}$$

Now x_{i_0} occurs in $f^*(x)$ with multiplicity $\#\text{Aut}(x)/(q-1)$ and therefore

$$\begin{aligned} \sum_i \#\text{Isom}_{W/\pi^n}(y_0, x_i) &= \begin{cases} \frac{\#\text{Aut}(x)}{q-1} & , \text{ if } \#\text{Isom}_{W/\pi^n}(y, x) \neq 0 \\ 0 & , \text{ otherwise} \end{cases} \\ &= \frac{1}{q-1} \#\text{Isom}_{W/\pi^n}(y, x). \end{aligned}$$

Therefore we only have to show that

$$(y_0 \cdot x_i)_v = \sum_{n \geq 1} \#\text{Isom}_{W/\pi^n}(y_0, x_i).$$

Let $Y \hookrightarrow \mathbb{P}_W^r$ be a projective embedding. Let \mathbb{A}_W^r be an affine part, which contains the intersection point s of x_i and y_0 . The coordinates with respect to this affine part are denoted by $y_0 = (\eta_1, \dots, \eta_r)$ and $x_i = (\xi_{i1}, \dots, \xi_{ir})$. In the local ring $\mathcal{O}_{Y,s}$ we have the local functions $z_j - \eta_j, z_j - \xi_{ij}$, respectively. The ideal generated by these functions contains all differences $(\eta_j - \xi_{ij})$ and therefore is the ideal $(\pi)^k$ with $k = \min_j v(\eta_j - \xi_{ij})$. From the definition of the intersection number we get

$$(y_0 \cdot x_i)_v = \dim_{W/\pi}(\mathcal{O}_{Y,s}/(z_j - \eta_j, z_j - \xi_{ij})) = \dim_{W/\pi}(W/\pi^k W) = k.$$

On the other hand

$$\#\text{Isom}_{W/\pi^n}(y_0, x_i) = \begin{cases} 0, & \eta_j \not\equiv \xi_{ij} \pmod{\pi^n} \text{ for some } j \\ 1, & \eta_j \equiv \xi_{ij} \pmod{\pi^n} \text{ for all } j, \end{cases}$$

because Y is a fine moduli scheme. It follows that

$$\sum_{n \geq 1} \#\text{Isom}_{W/\pi^n}(y_0, x_i) = k.$$

□

The degree of an isogeny u between two Drinfeld modules ϕ, ϕ' is by definition the ideal IJ , if $\ker u \simeq \mathbb{F}_q[T]/I \oplus \mathbb{F}_q[T]/J$.

THEOREM 3.3.4 *Let $P \in \mathbb{F}_q[T]$ be irreducible, $v|P$ a place of H with local parameter π and W the completion of the maximal unramified extension of*

O_v . Let $x = (\phi, \phi', u)$ be a Heegner point for the maximal order O_L . Let $\sigma_{\mathcal{A}} \in \text{Gal}(H/L)$. For λ, N without common divisor and $r_{\mathcal{A}}((\lambda)) = 0$ we get

$$(x \cdot T_{\lambda} x^{\sigma_{\mathcal{A}}})_v = \frac{1}{q-1} \sum_{n \geq 1} \# \text{Hom}_{W/\pi^n}(x^{\sigma_{\mathcal{A}}}, x)_{\text{deg } \lambda}.$$

The subscript $\text{deg } \lambda$ indicates that only homomorphisms of degree λ are counted. The sum is finite because $\# \text{Hom}_{W/\pi^n}(x^{\sigma_{\mathcal{A}}}, x)_{\text{deg } \lambda} = 0$ for n sufficiently large, because $\text{Hom}_W(x^{\sigma_{\mathcal{A}}}, x) = \bigcap_{n \geq 1} \text{Hom}_{W/\pi^n}(x^{\sigma_{\mathcal{A}}}, x)$ and $\# \text{Hom}_W(x^{\sigma_{\mathcal{A}}}, x)_{\text{deg } \lambda} = r_{\mathcal{A}}((\lambda)) = 0$ by assumption.

The rest of this section is used to prove this theorem. First of all we consider the easiest case, namely $P \nmid \lambda$. For the case $P | \lambda$ we need the Eichler-Shimura congruence and a congruence between points of level 0 and points of higher level. After that the formula of the theorem is proved at first for P split, then for P inert and finally for P ramified.

Suppose now that $P \nmid \lambda$. We have

$$\frac{d}{dt} \phi_{\lambda}(t) = \lambda \not\equiv 0 \pmod{P},$$

and so the zeroes of $\phi_{\lambda}(t)$ are pairwise disjoint mod P . If $u : x^{\sigma_{\mathcal{A}}} \rightarrow x$ is an isogeny over W/π^n of degree λ , then u is uniquely determined up to automorphism of x by $\ker u(t) \subset \ker \phi_{\lambda}(t)$. For a fixed u we have a unique lifting to a submodule of $\ker \phi_{\lambda}(t)$ over W , i.e., there exists y and an isogeny $x^{\sigma_{\mathcal{A}}} \rightarrow y$ of degree λ , such that

$$\begin{array}{ccc} x^{\sigma_{\mathcal{A}}} & \xrightarrow{\quad} & x \\ & \searrow & \downarrow \simeq \\ & & y \end{array}$$

commutes. Therefore

$$\# \text{Hom}_{W/\pi^n}(x^{\sigma_{\mathcal{A}}}, x)_{\text{deg } \lambda} = \sum_{y \in T_{\lambda} x^{\sigma_{\mathcal{A}}}} \# \text{Isom}_{W/\pi^n}(y, x).$$

By summation over n together with Proposition 3.3.3 the assertion of the theorem follows.

Now let $\lambda = P^t R$ with $t \geq 1$ and $P \nmid R$. The elements $y \in T_{\lambda} x^{\sigma_{\mathcal{A}}}$ are Heegner points of different levels and are defined over some extension H_s/H which is ramified at P . The analogue of the Eichler-Shimura congruence holds, i.e.

$$T_P \equiv F^* + F \pmod{P},$$

where F is the Frobenius correspondence and F^* is its dual correspondence on $X_0(N)$. This can be shown in the following way. Let $u : \phi \rightarrow \phi'$ be a cyclic isogeny of degree P given as a τ -polynomial. Then there exists a dual isogeny $v : \phi' \rightarrow \phi$, such that $\phi_P = v \cdot u$. Then either $v \equiv \tau^d \pmod{P}$ and consequently $\phi' \equiv \phi^F \pmod{P}$ or $u \equiv \tau^d \pmod{P}$ and consequently $\phi \equiv \phi'^F \pmod{P}$. This proves the Eichler-Shimura congruence.

By a simple induction we get

$$T_{P^t} \equiv F^{*t} + F^{*(t-1)}F + \dots + F^*F^{t-1} + F^t \pmod{P}.$$

LEMMA 3.3.5 *Let $y \in T_{P^t}z$. If s is the level of y , then y is defined over a class field H_s (cf. Proposition 3.2.5). Let $H_{s,v}$ be the completion at $v|P$ and W_s the valuation ring of the maximal unramified extension of $H_{s,v}$ with local parameter π_s . y is defined over W_s . If z has level 0 at P then it is defined over an unramified extension H_O/H (cf. Proposition 3.2.5), thus also over W . There exists a y_0 of level 0 defined over W , with $y \equiv y_0 \pmod{\pi_s}$.*

PROOF. For P ramified or split in L/K let $\sigma_{\mathfrak{p}} \in \text{Gal}(H_O/L)$ be the Frobenius of $\mathfrak{p}|P$ over L . For P inert let $\sigma_{\mathfrak{p}} = \sigma_P \in \text{Gal}(H_O/K)$ be the Frobenius of P over K . Then $\sigma_{\mathfrak{p}}$ operates on ϕ . The definition of Frobenius yields $\phi^{\sigma_{\mathfrak{p}}} \equiv \phi^F \pmod{\pi_s}$ and $\phi^{\sigma_{\mathfrak{p}}^{-1}} \equiv \phi' \pmod{\pi_s}$ with $\phi'^F \equiv \phi \pmod{\pi_s}$.

Now let $y \in T_{P^t}z$. From the Eichler-Shimura congruence we get the existence of y' and i with $0 \leq i \leq t$, such that $y'^{F^i} \equiv z \pmod{\pi_s}$ and $y \equiv y'^{F^{t-i}} \pmod{\pi_s}$ therefore $y \equiv y'^{\sigma_{\mathfrak{p}}^{t-i}} \equiv z^{\sigma_{\mathfrak{p}}^{t-2i}} \pmod{\pi_s}$, so we can take $y_0 = z^{\sigma_{\mathfrak{p}}^{t-2i}}$. \square

REMARK. In the ramified and in the inert case we have $y_0 = z^{\sigma_{\mathfrak{p}}}$ for t odd or $y_0 = z$ for t even. This holds because, if P is inert in L/K it is a principal ideal generated by an element which does not divide the conductor of O . This implies, that $\sigma_{\mathfrak{p}}^2 = 1$ for $\sigma_{\mathfrak{p}} \in \text{Gal}(H_O/K)$. If P is ramified in L/K we have that $\mathfrak{p}^2 = (P)$ is a principal ideal prime to the conductor. Therefore $\sigma_{\mathfrak{p}}^2 = 1$ also in this case.

LEMMA 3.3.6 *Let $y \in T_{P^t}z$ with level $s \geq 1$ and y_0, π_s as in Lemma 3.3.5. Then*

$$y \not\equiv y_0 \pmod{\pi_s^2}.$$

PROOF. The assertion is even true for the associated formal modules [Gr2, Prop. 5.3]. The formal module associated to a Drinfeld module is an extension of ϕ to a homomorphism $\phi^{(P)} : \mathbb{F}_q[T]_P \rightarrow W/\pi\{\{\tau\}\}$ where $\mathbb{F}_q[T]_P$ is the completion at P and $W/\pi\{\{\tau\}\}$ is the twisted power series ring. \square

Now we can go on with the proof of Theorem 3.3.4. We treat the cases P split, P inert and P ramified separately.

Suppose at first that P is split. Then ϕ has ordinary reduction and therefore $\text{Hom}_W(x^{\sigma_A}, x) = \text{Hom}_{W/\pi^n}(x^{\sigma_A}, x)$ for all $n \geq 1$, because $\text{Hom}_{W/\pi^n}(x, x) = \text{Hom}_W(x, x) = O_L$ and $\text{Hom}_{W/\pi^n}(x^{\sigma_A}, x) = \mathfrak{a}$. By assumption we have $r_{\mathcal{A}}((\lambda)) = 0$, so $\text{Hom}_{W/\pi^n}(x^{\sigma_A}, x)_{\text{deg } \lambda} = \emptyset$.

On the other hand let $y \in T_\lambda x^{\sigma_A}$ with $x \equiv y \pmod{\pi_s}$. Then Lemma 3.3.5 gives $y \equiv y_0 \pmod{\pi_s}$ for a $y_0 \in T_\lambda x^{\sigma_A}$ of level 0. Because $x \simeq y_0$ over W/π and therefore also over W , we get $x \simeq y_0$ over W , and so $x \in T_\lambda x^{\sigma_A}$, which contradicts the assumption $r_{\mathcal{A}}((\lambda)) = 0$. Therefore we get

$$(x \cdot T_\lambda x^{\sigma_A})_v = 0.$$

If P is inert then let $y_0 = z^{\sigma_P}$ for t odd and $y_0 = z$ for t even, respectively, as in the remark following Lemma 3.3.5. Then Lemma 3.3.5 and Lemma 3.3.6 yield $y \equiv y_0 \pmod{\pi_s}$, $y \not\equiv y_0 \pmod{\pi_s^2}$.

Each y of level $s = s(y)$ is defined over W_s , which is ramified of degree $e_s = q_P^{(s-1)}(q_P + 1)$ (cf. Proposition 3.2.5(2)).

We distinguish between the intersection pairing over W and W_s . For the latter we write $(\cdot)_{v,s}$. From the definition of the intersection multiplicity we get

$$(T_{P^t} z \cdot x)_v = \frac{1}{e_s} (T_{P^t} z \cdot x)_{v,s}$$

and further

$$\begin{aligned} (T_{P^t} z \cdot x)_v &= \frac{1}{e_s} \sum_{y \in T_{P^t} z} (y \cdot x)_{v,s} = & (3.3.1) \\ &= \sum_{\substack{s=0 \\ s \equiv t \pmod{2}}}^t \sum_{\substack{y \in T_{P^t} z \\ s(y)=s}} \frac{1}{(q-1)e_s} \sum_{n \geq 1} \#\text{Isom}_{W_s/\pi_s^n}(y, x) \\ &= \begin{cases} \left(\frac{1}{q-1} \sum_{n \geq 1} \#\text{Isom}_{W/\pi^n}(z, x) \right. \\ \left. + \sum_{\substack{s=1 \\ s \equiv t \pmod{2}}}^t \frac{\#\{y \in T_{P^t} z : s(y) = s\}}{(q-1) \cdot e_s} \#\text{Isom}_{W/\pi}(y_0, x) \right) & , \text{ if } t \text{ is even} \\ \sum_{\substack{s=1 \\ s \equiv t \pmod{2}}}^t \frac{\#\{y \in T_{P^t} z : s(y) = s\}}{(q-1) \cdot e_s} \#\text{Isom}_{W/\pi}(y_0, x) & , \text{ if } t \text{ is odd} \end{cases} \\ &= \begin{cases} \frac{1}{q-1} \left(\sum_{n \geq 1} \#\text{Isom}_{W/\pi^n}(z, x) + \frac{t}{2} \#\text{Isom}_{W/\pi}(z, x) \right) & , \text{ if } t \text{ is even} \\ \frac{1}{q-1} \cdot \frac{t+1}{2} \#\text{Hom}_{W/\pi}(z, x)_{\deg P} & , \text{ if } t \text{ is odd.} \end{cases} \end{aligned}$$

Summing over all $z \in T_R x$ we obtain $(P \nmid R)$

$$\begin{aligned} (T_\lambda x^{\sigma_A} \cdot x)_v &= \sum_{z \in T_R x^{\sigma_A}} (T_{P^t} z \cdot x)_v = \\ &= \begin{cases} \frac{1}{q-1} \sum_{n \geq 1} \# \text{Hom}_{W/\pi^n}(x^{\sigma_A}, x)_{\text{deg } R} \\ + \frac{t}{2(q-1)} \# \text{Hom}_{W/\pi}(x^{\sigma_A}, x)_{\text{deg } R} & , \text{ if } t \text{ is even} \\ \frac{t+1}{2(q-1)} \# \text{Hom}_{W/\pi}(x^{\sigma_A}, x)_{\text{deg } RP} & , \text{ if } t \text{ is odd.} \end{cases} \end{aligned}$$

LEMMA 3.3.7 a) *If t is even:*

$$\begin{aligned} \# \text{Hom}_{W/\pi^n}(x^{\sigma_A}, x)_{\text{deg } R} &= \# \text{Hom}_{W/\pi^{n+t/2}}(x^{\sigma_A}, x)_{\text{deg } \lambda} & \text{for } n \geq 1 \\ \# \text{Hom}_{W/\pi}(x^{\sigma_A}, x)_{\text{deg } R} &= \# \text{Hom}_{W/\pi^n}(x^{\sigma_A}, x)_{\text{deg } \lambda} & \text{for } n \leq t/2. \end{aligned}$$

b) *If t is odd:*

$$\begin{aligned} \# \text{Hom}_{W/\pi}(x^{\sigma_A}, x)_{\text{deg } RP} &= \# \text{Hom}_{W/\pi^{(t+1)/2}}(x^{\sigma_A}, x)_{\text{deg } \lambda} \\ \# \text{Hom}_{W/\pi}(x^{\sigma_A}, x)_{\text{deg } RP} &= \# \text{Hom}_{W/\pi^n}(x^{\sigma_A}, x)_{\text{deg } \lambda} \end{aligned}$$

for $n \leq (t+1)/2$.

PROOF. a) We have that $\phi_{P^{t/2}} \equiv \tau^{dt} \pmod{\pi^{t/2}}$ is an isogeny of degree P^t . If $u \in \text{Hom}_{W/\pi^n}(x^{\sigma_A}, x)_{\text{deg } R}$, then $\phi_{P^{t/2}}(u\phi_x^{\sigma_A} - \phi_x u) \equiv 0 \pmod{\pi^{n+t/2}}$ and therefore $\phi_{P^{t/2}} u \phi_x^{\sigma_A} \equiv \phi_x \phi_{P^{t/2}} u \pmod{\pi^{n+t/2}}$, i.e.

$$\phi_{P^{t/2}} u \in \text{Hom}_{W/\pi^{n+t/2}}(x^{\sigma_A}, x)_{\text{deg } \lambda}.$$

Now $P \nmid R$, thus $\pi \nmid u_0$ for $u \neq 0$, and $\phi_{P^{t/2}} u \equiv 0 \pmod{\pi^{n+t/2}}$ implies $u \equiv 0 \pmod{\pi^n}$, i.e. the map is injective.

Now let $u \in \text{Hom}_{W/\pi^{n+t/2}}(x^{\sigma_A}, x)_{\text{deg } \lambda}$, then there is a splitting $u = u_1 \cdot u_2$ with an isogeny u_1 of degree P^t and an isogeny u_2 of degree R . We have $u_1 \equiv \tau^{dt} \pmod{\pi^{t/2}}$, therefore the map is also surjective. This also shows that

$$\text{Hom}_{W/\pi}(x^{\sigma_A}, x)_{\text{deg } R} \longrightarrow \text{Hom}_{W/\pi^n}(x^{\sigma_A}, x)_{\text{deg } \lambda}$$

is bijective for $n \leq t/2$, which implies a).

b) Analogous to a) with

$$\begin{aligned} \text{Hom}_{W/\pi}(x^{\sigma_A}, x)_{\text{deg } RP} &\longrightarrow \text{Hom}_{W/\pi^{(t+1)/2}}(x^{\sigma_A}, x)_{\text{deg } \lambda} \\ f &\longmapsto \phi_{P^{(t-1)/2}} \cdot f. \end{aligned}$$

This completes the proof of Theorem 3.3.4, if P is inert.

Now let P be ramified. \mathfrak{p} a prime in L over P . Then $y_0 = z^{\sigma_{\mathfrak{p}}}$ for t odd and $y_0 = z$ for t even, respectively, where $\sigma_{\mathfrak{p}}$ is now the Frobenius over L . Lemma 3.3.5 and Lemma 3.3.6 tell us again that $y \equiv y_0 \pmod{\pi_s}$, $y \not\equiv y_0 \pmod{\pi_s^2}$.

$$\begin{aligned} (T_{\lambda} x^{\sigma_{\mathfrak{A}}} \cdot x)_v &= & (3.3.2) \\ &= \begin{cases} \frac{1}{q-1} \sum_{n \geq 1} \# \text{Isom}_{W/\pi^n}(z, x) + \frac{t}{q-1} \# \text{Isom}_{W/\pi}(z, x) \\ \frac{1}{q-1} \sum_{n \geq 1} \# \text{Isom}_{W/\pi^n}(z^{\sigma_{\mathfrak{p}}}, x) + \frac{t}{q-1} \# \text{Hom}_{W/\pi}(z^{\sigma_{\mathfrak{p}}}, x)_{\text{deg } P} \end{cases} \end{aligned}$$

for t even or odd, resp. Summing over all $z \in T_R x^{\sigma_{\mathfrak{A}}}$ yields

$$\begin{aligned} (T_{\lambda} x^{\sigma_{\mathfrak{A}}} \cdot x)_v &= \sum_{z \in T_R x^{\sigma_{\mathfrak{A}}}} (T_{P^t} z \cdot x)_v = \\ &= \begin{cases} \frac{1}{q-1} \sum_{n \geq 1} \# \text{Hom}_{W/\pi^n}(x^{\sigma_{\mathfrak{A}}}, x)_{\text{deg } R} \\ + \frac{t}{q-1} \# \text{Hom}_{W/\pi}(x^{\sigma_{\mathfrak{A}}}, x)_{\text{deg } R} & , \text{ if } t \text{ is even} \\ \frac{1}{q-1} \sum_{n \geq 1} \# \text{Hom}_{W/\pi^n}(x^{\sigma_{\mathfrak{A}\sigma_{\mathfrak{p}}}}, x)_{\text{deg } R} \\ + \frac{t}{q-1} \# \text{Hom}_{W/\pi}(x^{\sigma_{\mathfrak{A}\sigma_{\mathfrak{p}}}}, x)_{\text{deg } R} & , \text{ if } t \text{ is odd.} \end{cases} \end{aligned}$$

LEMMA 3.3.8 a) For t even

$$\begin{aligned} \# \text{Hom}_{W/\pi^n}(x^{\sigma_{\mathfrak{A}}}, x)_{\text{deg } R} &= \# \text{Hom}_{W/\pi^{n+t}}(x^{\sigma_{\mathfrak{A}}}, x)_{\text{deg } \lambda} & \text{for } n \geq 1 \\ \# \text{Hom}_{W/\pi}(x^{\sigma_{\mathfrak{A}}}, x)_{\text{deg } R} &= \# \text{Hom}_{W/\pi^n}(x^{\sigma_{\mathfrak{A}}}, x)_{\text{deg } \lambda} & \text{for } n \leq t. \end{aligned}$$

b) For t odd

$$\begin{aligned} \# \text{Hom}_{W/\pi^n}(x^{\sigma_{\mathfrak{A}\sigma_{\mathfrak{p}}}}, x)_{\text{deg } R} &= \# \text{Hom}_{W/\pi^{(t+n)}}(x^{\sigma_{\mathfrak{A}}}, x)_{\text{deg } \lambda} \\ \# \text{Hom}_{W/\pi}(x^{\sigma_{\mathfrak{A}\sigma_{\mathfrak{p}}}}, x)_{\text{deg } R} &= \# \text{Hom}_{W/\pi^n}(x^{\sigma_{\mathfrak{A}}}, x)_{\text{deg } \lambda} \end{aligned}$$

where the first equality holds for all $n \geq 1$ and the second one for all $n \leq t + 1$.

PROOF. The proof is analogous to the proof of the previous lemma. Using the facts that $f \mapsto \phi_{P^{t/2}} f$ for a) and $f \mapsto \phi_{\mathfrak{p}^t} f$ for b) are bijections of the sets. \square Now Theorem 3.3.4 is also completely proved.

3.4 QUATERNIONS

Assume that P is a prime which is non split in L . Then ϕ has supersingular reduction and therefore $\text{End}_{W/\pi}(\phi)$ is a maximal order in a quaternion algebra

B over K with maximal subfield L , unramified outside P and ∞ and having invariants $\text{inv}_P = 1/2$ and $\text{inv}_\infty = -1/2$ (cf. [Ge4]). The reduced norm of B/K will be denoted by nr and the reduced trace by tr . The norm of L/K will be denoted by $N_{L/K}(\cdot)$. Let $x = (\phi, \phi', \phi_n)$ be a Heegner point. Then

$$R := \text{End}_{W/\pi}(x) = \{f \in \text{End}_{W/\pi}(\phi) : \phi_n f = g \phi_n, \text{ for some } g \in \text{End}_{W/\pi}(\phi)\}$$

which is the same as $R = \text{End}_{W/\pi}(\phi) \cap \text{End}_{W/\pi}(\phi')$ in B . This is also an order in B , but is not a maximal one in general.

Let $\mathbb{F}_q[T]_P$ be the completion of $\mathbb{F}_q[T]$ at P . Then ϕ extends to a formal module

$$\phi^{(P)} : \mathbb{F}_q[T]_P \longrightarrow W/\pi\{\{\tau\}\}$$

where $W/\pi\{\{\tau\}\}$ is the twisted power series ring. Then we have the following analogue of the theorem of Serre-Tate [Dr] with $x^{(P)} = (\phi^{(P)}, \phi'^{(P)}, \phi_n^{(P)})$:

LEMMA 3.4.1

$$\text{End}_{W/\pi^n}(x) = \text{End}_{W/\pi}(x) \cap \text{End}_{W/\pi^n}(x^{(P)}).$$

PROOF. It suffices to show that

$$\text{End}_{W/\pi^n}(\phi) = \text{End}_{W/\pi}(\phi) \cap \text{End}_{W/\pi^n}(\phi^{(P)}).$$

We use induction. Let $f \in \text{End}_{W/\pi^n}(\phi) \cap \text{End}_{W/\pi^{n+1}}(\phi^{(P)})$. We have to show that $f \in \text{End}_{W/\pi^{n+1}}(\phi)$. Therefore let

$$f = f_0 + f_1\tau + \dots + f_i\tau^i + \dots \in W/\pi^{n+1}\{\{\tau\}\}$$

with $f\phi_a \equiv \phi_a f \pmod{\pi^{n+1}}$ for all $a \in \mathbb{F}_q[T]$ and assume that there is an $M \in \mathbb{N}$, such that $f_i \equiv 0 \pmod{\pi^n}$ for all $i \geq M$. Now ϕ has supersingular reduction at π , therefore

$$\phi_P = a_0 + a_1\tau + \dots + a_{2d}\tau^{2d} \equiv a_{2d}\tau^{2d} \pmod{\pi},$$

if $d = \deg P$. Now if $k > M + 2d$ then the k -th coefficient of $f\phi_P$ is

$$f_{k-2d}a_{2d}^{q^{k-2d}} + f_{k-2d+1}a_{2d-1}^{q^{k-2d+1}} + \dots + f_k a_0^q \equiv f_{k-2d}a_{2d}^{q^{k-2d}} \pmod{\pi^{n+1}},$$

because $f_i \equiv 0 \pmod{\pi^n}$ and $a_i \equiv 0 \pmod{\pi}$ for $i < 2d$. On the other hand this coefficient is equal to the k -th coefficient of $\phi_P f$ which is

$$a_0 f_k + a_1 f_{k-1}^q + \dots + a_{2d-1} f_{k-2d+1}^{q^{2d-1}} + a_{2d} f_{k-2d}^{q^{2d}} \equiv 0 \pmod{\pi^{n+1}}.$$

Here a_{2d} occurs only together with $f_{k-2d}^{q^{2d}}$ which vanishes modulo π^{n+1} because $d \geq 1$. Comparing both yields the assertion, namely $f_{k-2d} \equiv 0 \pmod{\pi^{n+1}}$ for all $k > M + 2d$. \square

From Lemma 3.4.1 and the corresponding statement for formal groups ([Gr2]) we immediately get for the order R in the quaternion algebra B :

PROPOSITION 3.4.2 *Let $\mathfrak{p}|P$ be a prime ideal in L and j in R with $B = L + Lj$. Then $\text{End}_{W/\pi^n}(x) =$*

$$\{b = b_1 + b_2j \in R : D \cdot N_{L/K}(b_2)nr(j) \equiv 0 \pmod{P(N_{L/K}(\mathfrak{p}))^{n-1}}\}.$$

Together with 3.3.4 we get

PROPOSITION 3.4.3 *Let x be a Heegner point for the maximal order O_L , $\sigma_{\mathcal{A}} \in \text{Gal}(H/L)$ and \mathfrak{a} an ideal from the ideal class \mathcal{A} corresponding to $\sigma_{\mathcal{A}}$. Let $R = \text{End}_{W/\pi}(x)$ and suppose $\gcd(\lambda, N) = 1$. Then*

$$(x \cdot T_{\lambda}x^{\sigma_{\mathcal{A}}})_v = \frac{1}{q-1} \sum_{\substack{b \in R\mathfrak{a}, b \notin L \\ nr(b) = \lambda N_{L/K}(\mathfrak{a})}} \begin{cases} \frac{1}{2}(1 + \text{ord}_P(nr(j)N_{L/K}(b_2))) & (P \text{ inert}) \\ \text{ord}_P(D nr(j)N_{L/K}(b_2)) & (P \text{ ramified}). \end{cases}$$

PROOF. Theorem 3.3.4 yields

$$(x \cdot T_{\lambda}x^{\sigma_{\mathcal{A}}})_v = \frac{1}{q-1} \sum_{n \geq 1} \#\text{Hom}_{W/\pi^n}(x^{\sigma_{\mathcal{A}}}, x)_{\text{deg } \lambda}.$$

With Lemma 3.2.2 and Proposition 3.4.2 we obtain

$$\begin{aligned} &(q-1)(x \cdot T_{\lambda}x^{\sigma_{\mathcal{A}}})_v \\ &= \sum_{n \geq 1} \#\{b = b_1 + b_2j \in R\mathfrak{a} : \\ &\quad (nr(b)) = (\lambda N_{L/K}(\mathfrak{a})), \quad D \cdot N_{L/K}(b_2)nr(j) \equiv 0 \pmod{P(N_{L/K}(\mathfrak{p}))^{n-1}}\} \\ &= \sum_{\substack{b \in R\mathfrak{a} \\ (nr(b)) = (\lambda N_{L/K}(\mathfrak{a}))}} \begin{cases} \#\{n : nr(j)N_{L/K}(b_2) \equiv 0 \pmod{P^{2n-1}}\}, & (P \text{ inert}) \\ \#\{n : D nr(j)N_{L/K}(b_2) \equiv 0 \pmod{P^n}\}, & (P \text{ ramified}) \end{cases} \\ &= \sum_{\substack{b \in R\mathfrak{a} \\ (nr(b)) = (\lambda N_{L/K}(\mathfrak{a}))}} \begin{cases} \frac{1}{2}(1 + \text{ord}_P(nr(j)N_{L/K}(b_2))) & (P \text{ inert}) \\ \text{ord}_P(D nr(j)N_{L/K}(b_2)) & (P \text{ ramified}). \end{cases} \end{aligned}$$

In the assertion of the proposition we sum only over $b \notin L$ or equivalently $b_2 \neq 0$. As we assume that $r_{\mathcal{A}}(\lambda) = 0$ this makes no difference because the elements with $b_2 = 0$ correspond to homomorphisms defined over W . \square

The next step towards our final formulae is to describe $R\mathfrak{a}$ explicitly. This can be done in almost the same way as in the paper of Gross and Zagier, therefore we omit the details.

First of all we want to describe the quaternion algebra by Hilbert symbols. This is obtained by class field theory.

PROPOSITION 3.4.4 *Let P be monic and inert. Let ϵ_D be the leading coefficient of D . Then there exists a monic, irreducible polynomial $Q \neq P$ and $\epsilon \in \mathbb{F}_q^* - \mathbb{F}_q^2$, such that*

1. $\deg PQD$ is odd,
2. $\epsilon PQ \equiv 1 \pmod{l}$ for all $l|D$.

In terms of the Hilbert symbol this means

$$\left(\frac{D, \epsilon PQ}{l}\right) = \begin{cases} 1 & \text{for } l \nmid P\infty \\ -1 & \text{for } l = P \text{ or } l = \infty. \end{cases}$$

Furthermore D is a quadratic residue modulo Q , i.e. Q is split in L/K .

COROLLARY 3.4.5 B is described by

$$B \simeq (D, \epsilon PQ), \quad B = L + Lj$$

with $j^2 = \epsilon PQ$.

We recall the following definition.

DEFINITION 3.4.6 The level (or reduced discriminant) rd of an order J in a quaternion algebra B is defined by

$$rd := n(\tilde{J})^{-1},$$

where $\tilde{J} = \{b \in B : \text{tr}(bJ) \subset \mathbb{F}_q[T]\}$ is the complement of J and $n(\tilde{J})$ is the gcd of the norms of elements in \tilde{J} .

Then we can show that R has level NP and O_L is optimally embedded in R , i.e. $R \cap L = O_L$.

The next step is to identify the order R in B .

PROPOSITION 3.4.7 The set

$$S = \{\alpha + \beta j : \alpha \in \mathfrak{d}^{-1}, \beta \in \mathfrak{d}^{-1}\mathfrak{q}^{-1}\mathfrak{n}, \alpha \equiv \beta \pmod{O_{\mathfrak{f}} \forall \mathfrak{f}|\mathfrak{d}}\}$$

is an order in $(D, \epsilon PQ)$ of level NP and O_L is optimally embedded in S . Here $\mathfrak{d} = (\sqrt{D})$ is the different, $\mathfrak{q}|Q$ is a prime of L and $O_{\mathfrak{f}}$ is the localization of O_L at \mathfrak{f} .

The proof is given by straightforward calculations (cf. Satz 3.18, [Ti1]).

Now R, S are both orders in which O_L is optimally embedded and sharing the same level. A Theorem of Eichler [Ei, Satz 7] states the existence of an ideal \mathfrak{b} of O_L with $R\mathfrak{b} = \mathfrak{b}S$.

So if \mathfrak{a} is an ideal in the class \mathcal{A} corresponding to $\sigma_{\mathcal{A}} \in \text{Gal}(H/L)$, and without loss of generality we assume that P is not a divisor of \mathfrak{a} , then

$$\begin{aligned} R\mathfrak{a} &= \mathfrak{b}S\mathfrak{b}^{-1}\mathfrak{a} = \\ &= \{\alpha + \beta j : \alpha \in \mathfrak{d}^{-1}\mathfrak{a}, \beta \in \mathfrak{d}^{-1}\mathfrak{q}^{-1}\mathfrak{n}\mathfrak{b}\mathfrak{b}^{-1}\bar{\mathfrak{a}}, \alpha \equiv (-1)^{\text{ord}_{\mathfrak{f}}(\mathfrak{b})}\beta \pmod{O_{\mathfrak{f}} \forall \mathfrak{f}|\mathfrak{d}}\}. \end{aligned}$$

The ideal class \mathcal{B} of \mathfrak{b} depends on the place $v|P$. But P is inert, therefore it is a principal prime ideal in L , and so P is totally split in H/L . The places over P are permuted transitively by the Galois group. If $\tau \in \text{Gal}(H/L)$ and W_τ is the maximal unramified extension of $O_{H,v\tau}$ and π_τ is a uniformizing parameter and $R_\tau = \text{End}_{W_\tau/\pi_\tau}(x)$, then $R_\tau = \mathfrak{c}_\tau R \mathfrak{c}_\tau^{-1}$, where \mathfrak{c}_τ lies in the ideal class corresponding to τ . If \mathfrak{b}_τ is defined by $R_\tau \mathfrak{b}_\tau = \mathfrak{b}_\tau S$, it follows that $\mathfrak{b}_\tau = \mathfrak{b} \mathfrak{c}_\tau$. Now we can give a more explicit formula for the height pairing at inert primes. We define $d(\mu, D)$ to be the number of common prime factors of μ and D .

PROPOSITION 3.4.8 *For P inert we get the formula:*

$$\begin{aligned} & \langle (x) - (\infty), T_\lambda((x)^{\sigma_A} - (0)) \rangle_P \\ &= \sum_{v|P} -(x \cdot T_\lambda x^{\sigma_A})_v \ln q_v \\ &= -u^2 \frac{1}{q-1} \ln q \deg P \sum_{\substack{\mu \in \mathbb{F}_q[T] - \{0\} \\ \deg \mu \leq \deg \lambda D - \deg NP}} \text{ord}_P(P^2 \mu) \cdot r_{\mathcal{A}}((NP\mu - \lambda D)) \cdot \\ & \quad 2^{d(\mu, D)} R_{\{\mathcal{A}[\mathfrak{q}\mathfrak{n}]\}}((\mu)) \frac{1 - \delta_{(NP\mu - \lambda D)NP\mu}}{2} \end{aligned}$$

with

$$u = |O_L^*/\mathbb{F}_q^*| = \begin{cases} q + 1, & \text{if } \deg D = 0 \\ 1, & \text{otherwise.} \end{cases}$$

Here δ is again the local norm symbol at ∞ (cf. the definition of δ in section 2.2 following equation (2.2.5)). $R_{\{\mathcal{A}[\mathfrak{q}\mathfrak{n}]\}}(\mu)$ denotes the number of integral ideals \mathfrak{c} , which lie in a class differing from the class $\mathcal{A}[\mathfrak{q}\mathfrak{n}]$ by a square in the class group and with norm (μ) .

PROOF. Let \mathfrak{a} be a fixed ideal in \mathcal{A} and let λ_0 be a fixed generator of $N_{L/K}(\mathfrak{a})$. We calculate the height pairing using Proposition 3.4.3 together with the explicit description of $R\mathfrak{a}$.

If $b = \alpha + \beta j \in R_\tau \mathfrak{a}$, i.e. $\alpha \in \mathfrak{d}^{-1} \mathfrak{a}, \beta \in \mathfrak{d}^{-1} \mathfrak{q}^{-1} \mathfrak{n} \mathfrak{b}_\tau \overline{\mathfrak{b}_\tau}^{-1} \mathfrak{a}$, $\alpha \equiv (-1)^{\text{ord}_f(\mathfrak{b})} \beta \pmod{O_f}$, we define

$$\mathfrak{c} := (\beta) \mathfrak{d} \mathfrak{q} \mathfrak{n}^{-1} \mathfrak{b}_\tau^{-1} \overline{\mathfrak{b}_\tau} \mathfrak{a}^{-1} \in [\mathfrak{q}\mathfrak{n}^{-1}] \mathcal{B}^2 \mathcal{A}$$

and

$$\nu := -N_{L/K}(\alpha) D \lambda_0^{-1} \in \mathbb{F}_q[T]$$

$$\mu := -\epsilon N_{L/K}(\beta) D Q N^{-1} \lambda_0^{-1} \in \mathbb{F}_q[T].$$

Then \mathfrak{c} is integral and

$$\text{nr}(\alpha + \beta j) = N_{L/K}(\alpha) - \epsilon P Q N_{L/K}(\beta) = (-\nu + NP\mu) D^{-1} \lambda_0$$

thus

$$(\text{nr}(\alpha + \beta j)) = (\lambda \lambda_0) \iff (-\nu + NP\mu) = (D\lambda) \iff \nu = NP\mu - \tilde{\epsilon}D\lambda$$

for a uniquely determined $\tilde{\epsilon} \in \mathbb{F}_q^*$.

Now if $\mu \in \mathbb{F}_q[T]$ and $\epsilon \in \mathbb{F}_q^*$ are given, then the number of $\alpha \in \mathfrak{d}^{-1}\mathfrak{a}$ with $N_{L/K}(\alpha) = -\nu D^{-1}\lambda_0$ is $r_{\mathfrak{a}, \lambda_0}(NP\mu - \tilde{\epsilon}D\lambda)$.

β is determined by the integral ideal \mathfrak{c} up to multiplication with elements of O_L^* .

If $\deg D = 0$ there are no further restrictions on α, β . Now suppose $\deg D > 0$. We have that $\tilde{\epsilon}\lambda\lambda_0 = N_{L/K}(\alpha) - \epsilon PQ N_{L/K}(\beta)$ is integral and that $\epsilon PQ \equiv 1 \pmod{f}$ for all $f|D$. Therefore $\alpha \equiv \pm\beta \pmod{O_f}$.

Let $(\sqrt{D}) = \mathfrak{p}_1 \cdots \mathfrak{p}_t$, we can modify \mathfrak{b}_τ modulo squares of classes to find \mathfrak{b} with

$$\mathfrak{b} = \mathfrak{b}_\tau \cdot \mathfrak{p}_1^{\epsilon_1} \cdots \mathfrak{p}_t^{\epsilon_t}$$

with $\epsilon_i \in \{0, 1\}$ such that

$$\alpha \equiv (-1)^{\text{ord}_{\mathfrak{p}_i}(\mathfrak{b})} \beta \pmod{O_{\mathfrak{p}_i}}.$$

The ϵ_i are uniquely determined if $\beta \notin O_f$, which is the case exactly when $\mathfrak{p}_i \nmid \mu$. If $\beta \in O_f$ then both choices of ϵ_i give the correct congruence. Thus there are $2^{d(\mu, D)}$ ideal classes which differ from the class of \mathfrak{b}_τ only by classes of order 2 and which have the given congruence for α and β . The only exception to this is when $D|\mu$. In this case all ϵ_i can be chosen arbitrarily, so for each d -tuple $(\epsilon_1, \dots, \epsilon_d)$ also $(-\epsilon_1, \dots, -\epsilon_d)$ is possible but both give the same class. The number of classes is therefore divided by two. On the other hand the congruences fix β , except when all congruences are trivial. So the number of pairs (α, β) doubles in the latter case.

The existence of β is equivalent to $\epsilon^{-1}\mu Q^{-1}N\lambda_0$ being a norm of an element in L^* . As we already know that it is the norm of an ideal, we get the following local condition:

$$\epsilon^{-1}\mu Q^{-1}N\lambda_0 \in N_{L/K}(L^*) \iff \delta_{\epsilon^{-1}\mu Q^{-1}N\lambda_0} = 1.$$

By definition of Q we have $\left(\frac{D, \epsilon PQ}{\infty}\right) = -1$. Therefore the condition is equivalent to $\delta_{\mu PN\lambda_0} = -1$.

For a given α the number of β in some class \mathfrak{b}_τ is then

$$2^{d(\mu, D)} R_{\{\mathcal{A}[\mathfrak{q}\mathfrak{n}]\}}(\mu) \frac{1 - \delta_{\mu PN\lambda_0}}{2}.$$

This shows that

$$\begin{aligned} & \langle (x) - (\infty), T_\lambda((x)^{\sigma_A} - (0)) \rangle_P \\ &= -u \frac{1}{q-1} \ln q_v \sum_{\substack{\mu \in \mathbb{F}_q[T] - \{0\} \\ \deg \mu \leq \deg \lambda D - \deg NP}} \sum_{\tilde{\epsilon} \in \mathbb{F}_q^*} \frac{1}{2} (1 + \text{ord}_P(P\mu)) \cdot \\ & \quad r_{\mathfrak{a}, \lambda_0}(NP\mu - \tilde{\epsilon}\lambda D) \cdot 2^{d(\mu, D)} R_{\{\mathcal{A}[\mathfrak{q}\mathfrak{n}]\}}((\mu)) \frac{1 - \delta_{NP\mu\lambda_0}}{2}. \end{aligned}$$

If $r_{\mathfrak{a}, \lambda_0}((NP\mu - \tilde{\epsilon}\lambda D)) \neq 0$ then $\delta_{\lambda_0} = \delta_{NP\mu - \tilde{\epsilon}\lambda D}$, $\ln q_v = 2 \deg P \ln q$. If we substitute this and change $\mu \mapsto \tilde{\epsilon}\mu$ we get

$$\begin{aligned} & \langle (x) - (\infty), T_\lambda((x)^{\sigma_A} - (0)) \rangle_P \\ &= -u \deg P \ln q \sum_{\substack{\mu \in \mathbb{F}_q[T] - \{0\} \\ \deg \mu \leq \deg \lambda D - \deg NP}} \text{ord}_P(P^2\mu) \sum_{\tilde{\epsilon} \in \mathbb{F}_q^*} r_{\mathfrak{a}, \lambda_0}(\tilde{\epsilon}(NP\mu - \lambda D)) \cdot \\ & \quad 2^{d(\mu, D)} R_{\{\mathcal{A}[\mathfrak{q}\mathfrak{n}]\}}((\mu)) \frac{1 - \delta_{NP\mu(NP\mu - \lambda D)}}{2}. \end{aligned}$$

Using the identity

$$\frac{1}{q-1} \sum_{\tilde{\epsilon} \in \mathbb{F}_q^*} r_{\mathfrak{a}, \lambda_0}(\tilde{\epsilon}(NP\mu - \lambda D)) = ur_{\mathcal{A}}((NP\mu - \lambda D))$$

we get the formula of the proposition. □

We specialize this result to the case where D is irreducible. Then $u = 1$ because $\deg D > 0$. $d(\mu, D) = t(\mu, D) = 0$ or 1 for $t(\mu, D)$ defined in (2.8.1) and therefore $2^{d(\mu, D)} = t(\mu, D) + 1$.

LEMMA 3.4.9 *If D is irreducible, then*

$$R_{\{\mathcal{A}[\mathfrak{q}\mathfrak{n}]\}}((\mu)) \frac{1 - \delta_{-NQ\mu\lambda_0}}{2} = \frac{1}{q-1} \sum_{c|\mu} \left[\frac{D}{c} \right] \frac{1 - \delta_{-NQ\mu\lambda_0}}{2}.$$

PROOF. One has to show that

$$R_{\{\mathcal{A}[\mathfrak{q}\mathfrak{n}]\}}((\mu)) \frac{1 - \delta_{-NQ\mu\lambda_0}}{2} = \#\{\mathfrak{c} \text{ integral ideal} : N_{L/K}(\mathfrak{c}) = (\mu)\}.$$

Then the assertion follows by comparing the coefficients of both sides of $\zeta_L(s) = \zeta_K(s)L_D(s)$. If $\deg D$ is odd then every class is a square in the class group and we are done. If $\deg D$ is even and if $-NQ\mu\lambda_0$ is a norm, then $\deg N_{L/K}(\mathfrak{a}_0\mathfrak{q}\mathfrak{n}) \equiv \deg \mu \pmod{2}$. $\#\{\mathfrak{c} \text{ integral ideal} : N_{L/K}(\mathfrak{c}) = (\mu)\}$ is the sum of $r_{\tilde{\mathcal{A}}}((\mu))$ over all classes $\tilde{\mathcal{A}}$, which is equal to the sum over all square classes if $\mu \equiv 0 \pmod{2}$ and equal to the sum over all non-square classes if $\mu \not\equiv 0 \pmod{2}$. In any case this is $R_{\{\mathcal{A}[\mathfrak{q}\mathfrak{n}]\}}(\mu)$. □

From this lemma the following corollary follows.

COROLLARY 3.4.10 *Let P be inert and D be irreducible. Then*

$$\begin{aligned} & \langle (x) - (\infty), T_\lambda((x)^{\sigma_A} - (0)) \rangle_P \\ &= \sum_{v|P} -(x \cdot T_\lambda x^{\sigma_A})_v \ln q_v \\ &= -\frac{\ln q}{q-1} \sum_{\substack{\mu \in \mathbb{F}_q[T] - \{0\} \\ \deg \mu \leq \deg \lambda D - \deg NP}} \deg P \operatorname{ord}_P(P^2 \mu) \cdot r_{\mathcal{A}}((NP\mu - \lambda D)) \cdot \\ & \quad (t(\mu, D) + 1) \left(\sum_{c|\mu} \left[\frac{D}{c} \right] \right) \frac{1 - \delta_{(NP\mu - \lambda D)NP\mu}}{2}. \end{aligned}$$

If P is ramified we can get a similar formula arguing in the same way as for the inert case. Let $\mathfrak{p}|P$ be a prime over P and let f ($= 1$ or 2) be the order of the place in the class group. Then \mathfrak{p} splits in H into h/f factors all of which have residue degree f over the residue field of \mathfrak{p} .

PROPOSITION 3.4.11 *There exists $\epsilon \in \mathbb{F}_q^* - \mathbb{F}_q^2$ and a monic polynomial $Q \in \mathbb{F}_q[T]$ with $\deg QD$ odd, such that $\epsilon Q \equiv 1 \pmod{l}$ for all $l|D$, $l \neq P$ and*

$$\left(\frac{\epsilon Q}{P} \right) = -1.$$

Also Q is split in L/K , $B \simeq (D, \epsilon Q)$ and $B = L + Lj$ with $j^2 = \epsilon Q$.

PROPOSITION 3.4.12 *The order*

$$S = \{ \alpha + \beta j : \alpha \in \mathfrak{p}\mathfrak{d}^{-1}, \beta \in \mathfrak{p}\mathfrak{d}^{-1}\mathfrak{q}^{-1}\mathfrak{n}, \alpha \equiv \beta \pmod{O_{\mathfrak{f}}} \forall \mathfrak{f}|\mathfrak{d} \}$$

in $(D, \epsilon Q)$ has level $N \cdot P$ and O_L is optimally embedded in S .

From this and the Theorem of Eichler we get

$$R_\tau \mathfrak{a} = \mathfrak{b}_\tau S \mathfrak{b}_\tau^{-1} \mathfrak{a} =$$

$$= \{ \alpha + \beta j : \alpha \in \mathfrak{p}\mathfrak{d}^{-1} \mathfrak{a}, \beta \in \mathfrak{p}\mathfrak{d}^{-1} \mathfrak{q}^{-1} \mathfrak{n} \mathfrak{b}_\tau \mathfrak{b}_\tau^{-1} \mathfrak{a}, \alpha \equiv (-1)^{\operatorname{ord}_{\mathfrak{f}}(\mathfrak{b}_\tau)} \beta \pmod{O_{\mathfrak{f}}} \}.$$

In the same way as for the inert primes we can show:

PROPOSITION 3.4.13 *Assume again that $r_{\mathcal{A}}((\lambda)) = 0$. Let P be ramified. Then $\deg D > 0$ and $u = 1$. We have:*

$$\begin{aligned} & \langle (x) - (\infty), T_\lambda((x)^{\sigma_A} - (0)) \rangle_P \\ &= \sum_{v|P} -(x \cdot T_\lambda x^{\sigma_A})_v \ln q_v \\ &= -\frac{\ln q}{q-1} \deg P \sum_{\substack{\mu \in \mathbb{F}_q[T] - \{0\} \\ \deg \mu \leq \deg \lambda D - \deg NP}} \operatorname{ord}_P(P\mu) \cdot r_{\mathcal{A}}((NP\mu - \lambda D)) \cdot \\ & \quad 2^{d(\mu, D)} R_{\{\mathcal{A}[\mathfrak{q}\mathfrak{n}]\}}(P\mu) \frac{1 - \delta_{(NP\mu - \lambda D)NP\mu}}{2}. \end{aligned}$$

If D is irreducible we get the formula:

$$\begin{aligned} & \langle (x) - (\infty), T_\lambda((x)^{\sigma_A} - (0)) \rangle_P \\ &= -\frac{\ln q}{q-1} \deg P \sum_{\substack{\mu \in \mathbb{F}_q[T] - \{0\} \\ \deg \mu \leq \deg \lambda D - \deg NP}} \text{ord}_P(P\mu) \cdot r_{\mathcal{A}}((NP\mu - \lambda D)) \cdot \\ & \quad 2 \left(\sum_{\mu|c} \left[\frac{D}{c} \right] \right) \frac{1 - \delta_{(NP\mu - \lambda D)NP\mu}}{2}. \end{aligned}$$

PROOF. The proof is just as in the inert case. The only thing we want to mention is that all classes for \mathfrak{b} are counted. But the sum runs only over the $v|P$, so only over the h/f classes mod \mathfrak{p} . On the other hand there is a factor f from $\ln q_v = f \cdot \deg P \ln q$ which compensates for this. \square

Now we sum up the formulae for all finite P in the case that D is irreducible.

THEOREM 3.4.14 *Let $N \in \mathbb{F}_q[T]$ square free, $D \in \mathbb{F}_q[T]$ irreducible and $D \equiv b^2 \pmod{N}$ for some $b \in \mathbb{F}_q[T]$. Let $L = K(\sqrt{D})$ and let H denote the Hilbert class field of L . Let $\sigma_{\mathcal{A}} \in \text{Gal}(H/L)$ and suppose that \mathcal{A} is the corresponding ideal class.*

Let $\lambda \in \mathbb{F}_q[T]$ be such that $\text{gcd}(\lambda, N) = 1$ and $r_{\mathcal{A}}((\lambda)) = 0$. Then

$$\begin{aligned} & \sum_{P \neq \infty} \langle (x) - (\infty), T_\lambda((x)^{\sigma_A} - (0)) \rangle_P \\ &= -\frac{\ln q}{q-1} \sum_{\substack{\mu \in \mathbb{F}_q[T] - \{0\} \\ \deg \mu N \leq \deg \lambda D}} r_{\mathcal{A}}((\mu N - \lambda D)) \cdot (1 - \delta_{(\mu N - \lambda D)\mu N}) \\ & \quad \left[- (t(\mu, D) + 1) \left(\sum_{c|\mu} \left[\frac{D}{c} \right] \deg c \right) + \left(\sum_{c|\mu} \left[\frac{D}{c} \right] \deg \mu \right) \right]. \end{aligned}$$

PROOF. The sum over all $P \neq \infty$ of the formulae in Proposition 3.4.8 and in Proposition 3.4.13 gives

$$\begin{aligned} & \sum_{P \neq \infty} \langle (x) - (\infty), T_\lambda((x)^{\sigma_A} - (0)) \rangle_P \\ &= -\frac{\ln q}{q-1} \sum_{\substack{\mu \in \mathbb{F}_q[T] - \{0\} \\ \deg \mu N \leq \deg \lambda D}} r_{\mathcal{A}}((\mu N - \lambda D)) \cdot (1 - \delta_{(\mu N - \lambda D)\mu N}) \\ & \quad \left[(t(\mu, D) + 1) \sum_{\substack{P|\mu \\ P \text{ inert}}} \deg P \text{ord}_P(P\mu) \left(\sum_{c|\frac{\mu}{P}} \left[\frac{D}{c} \right] \right) \right. \\ & \quad \left. + 2 \text{ord}_D(\mu) \deg D \left(\sum_{c|\frac{\mu}{D}} \left[\frac{D}{c} \right] \right) \right]. \end{aligned}$$

Some calculations with the Dirichlet character show that

$$\begin{aligned} & \sum_{\substack{P|\mu \\ P \text{ inert}}} \deg P \operatorname{ord}_P(P\mu) \left(\sum_{c|\frac{\mu}{P}} \left[\frac{D}{c} \right] \right) \\ &= \left(\sum_{c|\mu} \left[\frac{D}{c} \right] \right) \deg \mu - \operatorname{ord}_D(\mu) \deg D \left(\sum_{c|\mu} \left[\frac{D}{c} \right] \right) \\ & \quad - 2 \left(\sum_{c|\mu} \left[\frac{D}{c} \right] \deg c \right). \end{aligned}$$

Substituting this yields

$$\begin{aligned} & \sum_{P \neq \infty} \langle (x) - (\infty), T_\lambda((x)^{\sigma_A} - (0)) \rangle_P \\ &= -\frac{\ln q}{q-1} \sum_{\substack{\mu \in \mathbb{F}_q[T] - \{0\} \\ \deg \mu N \leq \deg \lambda D}} r_{\mathcal{A}}((\mu N - \lambda D)) \cdot (1 - \delta_{(\mu N - \lambda D)\mu N}) \\ & \quad \cdot \left[(t(\mu, D) + 1) \left(\sum_{c|\mu} \left[\frac{D}{c} \right] \right) \deg \mu \right. \\ & \quad \left. - \deg D (t(\mu, D) + 1) \operatorname{ord}_D(\mu) \left(\sum_{c|\mu} \left[\frac{D}{c} \right] \right) \right. \\ & \quad \left. - 2(t(\mu, D) + 1) \left(\sum_{c|\mu} \left[\frac{D}{c} \right] \deg c \right) + 2 \operatorname{ord}_D(\mu) \deg D \left(\sum_{c|\mu} \left[\frac{D}{c} \right] \right) \right]. \end{aligned}$$

For $r_{\mathcal{A}}((\mu N - \lambda D)) \neq 0$ we observe that (cf. Lemma 2.8.1):

$$(1 - \delta_{(\mu N - \lambda D)\mu N})(t(\mu, D) - 1) \left(\sum_{c|\frac{\mu}{P}} \left[\frac{D}{c} \right] \right) = 0$$

from which the theorem follows. \square

3.5 THE LOCAL HEIGHT PAIRING AT ∞

At first we assume that $r_{\mathcal{A}}((\lambda)) = 0$. The local height pairing at places over ∞ can be calculated by Green's functions as described in [Ti3]. This approach is based on the general formula (3.1.1). This means that there are contributions coming from the intersection of horizontal divisors and from the intersection with the fibre components. In contrast to [Ti3] here we always consider Γ as a subgroup of $GL_2(\mathbb{F}_q[T])$ instead of $PGL_2(\mathbb{F}_q[T])$, so the formulae differ by a factor $q - 1$.

The cases $\deg D$ odd and $\deg D$ even will be treated separately starting with the former case. In the whole section we again assume that D is irreducible. We write $|z|_i = \min\{|z - y| : y \in K_\infty\}$ and

$$d(z, z') = \log_q \frac{|z - z'|^2}{|z|_i |z'|_i}.$$

3.5.1 DEG D ODD

If z, z' are two elements in Ω with $\log_q |z|_i, \log_q |z'|_i \notin \mathbb{Z}$ and which represent L_∞ -rational points on the algebraic curve $X_0(N)$ then by definition of the Green's function G ([Ti3, Def 2]) and Theorem 2 together with Proposition 8 of [Ti3] we have

$$\begin{aligned} & \langle (z) - (\infty), (z') - (0) \rangle_{L_\infty} \\ &= (-\ln q)(G(z, z') - G(z', \infty) - G(0, z) + G(0, \infty)) \\ &= \frac{-\ln q}{q-1} \left[\sum_{\substack{\gamma \in \Gamma \\ d(\gamma z, z') \leq 0}} \left(\frac{q+1}{2(q-1)} - d(\gamma z, z') \right) \right. \\ & \quad \left. + \lim_{s \rightarrow 1} \left[\frac{q+1}{2(q-1)} \sum_{\substack{\gamma \in \Gamma \\ d(\gamma z, z') > 0}} q^{-d(\gamma z, z')s} - \frac{2\kappa(q-1)}{1-q^{1-s}} \right] \right. \\ & \quad \left. - \lim_{s \rightarrow 1} \left[q^{1/2}(q^2-1)(Ei_s^{(N)}(z') + Ei_s^{(N)}\left(\frac{1}{Nz}\right)) - \frac{4\kappa(q-1)}{1-q^{1-s}} \right] \right] \end{aligned}$$

with $\kappa := \frac{q^2-1}{2[GL_2(\mathbb{F}_q[T]) : \Gamma_0(N)]}$. Here $Ei_s^{(N)}(z)$ is the Eisenstein series

$$Ei_s^{(N)}(z) = |z|_i^s \sum_{\substack{(c,d), N|c \\ \gcd(c,d)=1}} |cz + d|^{-2s}.$$

We define

$$R_N := \left\{ \begin{pmatrix} a & b \\ c & d \end{pmatrix} \in \text{Mat}_{2 \times 2}(\mathbb{F}_q[T]) : N|c, \det \begin{pmatrix} a & b \\ c & d \end{pmatrix} \neq 0 \right\}.$$

If $\lambda \in \mathbb{F}_q[T]$, $\lambda \neq 0$ we get

$$\begin{aligned} & \langle (z) - (\infty), T_\lambda((z') - (0)) \rangle_{L_\infty} \\ &= \frac{-\ln q}{q-1} \left[\sum_{\substack{\gamma \in R_N, (\det \gamma) = (\lambda) \\ d(z, \gamma z') \leq 0}} \left(\frac{q+1}{2(q-1)} - d(z, \gamma z') \right) \right. \\ & \quad + \lim_{s \rightarrow 1} \left[\frac{q+1}{2(q-1)} \sum_{\substack{\gamma \in R_N, (\det \gamma) = (\lambda) \\ d(z, \gamma z') > 0}} q^{-d(z, \gamma z')s} - \frac{2\kappa\sigma_1(\lambda)}{1-q^{1-s}} \right] \\ & \quad - \lim_{s \rightarrow 1} \left[q^{1/2}(q+1) \left(q^{\deg \lambda s} \sigma_{1-2s}(\lambda) Ei_s^{(N)}(z') + \sigma_1(\lambda) Ei_s^{(N)}\left(\frac{1}{Nz}\right) \right) \right. \\ & \quad \left. \left. - \frac{4\kappa\sigma_1(\lambda)}{1-q^{1-s}} \right] \right] \end{aligned}$$

with $\sigma_s(\lambda) := \sum_{a|\lambda} q^{\deg a s}$ for any s . Now we specialize z to be a Heegner point and z' to be a conjugate under the Galois group.

Let $\lambda \in \mathbb{F}_q[T] \setminus \{0\}$ with $r_{\mathcal{A}}((\lambda)) = 0$. Let \mathfrak{n} be an ideal with $\mathfrak{n}\bar{\mathfrak{n}} = (N)$. For $j = 1, 2$ let $\mathfrak{a}_j = A_j\mathbb{F}_q[T] + (B_j + \sqrt{D})\mathbb{F}_q[T]$ be two ideals contained in \mathfrak{n} with $N_{L/K}(\mathfrak{a}_j) = (A_j)$ and let \mathcal{A}_j be the corresponding ideal classes. Then this data defines two Heegner points which are represented in the upper half plane by $\tau_j = \frac{-B_j + \sqrt{D}}{2A_j}$. We have that $\log_q |\tau_j|_i = \log_q |\sqrt{D}/A_j| \notin \mathbb{Z}$.

If \mathcal{A} is an ideal class and $\sigma_{\mathcal{A}} \in \text{Gal}(H/L)$ the corresponding automorphism we get

$$\begin{aligned} & \langle (\tau) - (\infty), T_\lambda((\tau)^{\sigma_{\mathcal{A}}} - (0)) \rangle_\infty \\ &= \sum_{v|\infty} \langle (\tau) - (\infty), T_\lambda((\tau)^{\sigma_{\mathcal{A}}} - (0)) \rangle_v \\ &= \sum_{\substack{\mathcal{A}_1, \mathcal{A}_2 \in \mathcal{C}^1(O_L) \\ \mathcal{A}_1 \mathcal{A}_2^{-1} = \mathcal{A}}} \langle (\tau_{\mathcal{A}_1}) - (\infty), T_\lambda((\tau_{\mathcal{A}_2}) - (0)) \rangle_{L_\infty} \\ &= \frac{-\ln q}{q-1} \left[\lim_{s \rightarrow 1} \left[F_1(\mathcal{A}, s) - \frac{2\kappa h_L \sigma_1(\lambda)}{1-q^{1-s}} \right] \right. \\ & \quad \left. - \lim_{s \rightarrow 1} \left[F_2(\mathcal{A}, s) - \frac{4\kappa h_L \sigma_1(\lambda)}{1-q^{1-s}} \right] \right] \tag{3.5.1} \end{aligned}$$

where τ is one of the $\tau_{\mathcal{A}_j}$, $\kappa = \frac{(q^2 - 1)}{2[\mathrm{GL}_2(\mathbb{F}_q[T]) : \Gamma_0(N)]}$ and

$$F_1(\mathcal{A}, s) := \sum_{\substack{\mathcal{A}_1, \mathcal{A}_2 \in \mathcal{C}l(\mathcal{O}_L) \\ \mathcal{A}_1 \mathcal{A}_2^{-1} = \mathcal{A}}} \left[\sum_{\substack{\gamma \in R_N, (\det \gamma) = (\lambda) \\ d(\gamma \tau_{\mathcal{A}_1}, \tau_{\mathcal{A}_2}) \leq 0}} \left(\frac{q+1}{2(q-1)} - d(\gamma \tau_{\mathcal{A}_1}, \tau_{\mathcal{A}_2}) \right) + \frac{q+1}{2(q-1)} \sum_{\substack{\gamma \in R_N, (\det \gamma) = (\lambda) \\ d(\gamma \tau_{\mathcal{A}_1}, \tau_{\mathcal{A}_2}) > 0}} q^{-d(\gamma \tau_{\mathcal{A}_1}, \tau_{\mathcal{A}_2})s} \right]$$

and

$$F_2(\mathcal{A}, s) := \sum_{\substack{\mathcal{A}_1, \mathcal{A}_2 \in \mathcal{C}l(\mathcal{O}_L) \\ \mathcal{A}_1 \mathcal{A}_2^{-1} = \mathcal{A}}} q^{1/2}(q+1) \cdot \left[q^{\deg \lambda s} \sigma_{1-2s}(\lambda) E_{i_s}^{(N)}(\tau_{\mathcal{A}_2}) + \sigma_1(\lambda) E_{i_s}^{(N)}\left(\frac{1}{N\tau_{\mathcal{A}_1}}\right) \right]. \tag{3.5.2}$$

At first we calculate the function $F_1(\mathcal{A}, s)$. The following proposition combined with the convergence of the limits in (3.5.1) implies the existence of the limits in section 2.8 (cf. the corresponding remark there).

PROPOSITION 3.5.1 *The following equation for F_1 holds:*

$$F_1(\mathcal{A}, s) = \sum_{\substack{\mu \neq 0 \\ \deg(\mu N) \leq \deg(\lambda D)}} r_{\mathcal{A}}((\mu N - \lambda D)) \left(\sum_{c|\mu} \left[\frac{D}{c} \right] \right) (t(\mu, D) + 1) \cdot \frac{1 + \delta_{(\mu N - \lambda D)\mu N}}{2} \left(-\deg \mu N + \deg \lambda D + \frac{q+1}{2(q-1)} \right) + \frac{q+1}{2(q-1)} \sum_{\substack{\mu \in \mathbb{F}_q[T] - \{0\} \\ \deg \mu N > \deg \lambda D}} r_{\mathcal{A}}((\mu N - \lambda D)) \left(\sum_{c|\mu} \left[\frac{D}{c} \right] \right) \cdot (t(\mu, D) + 1) q^{-(\deg \mu N - \deg \lambda D)s}.$$

PROOF. We define

$$M(\mathbf{a}_1, \mathbf{a}_2, \mathbf{n}) = \{(\alpha, \beta) \in \mathfrak{a}_1^{-1} \bar{\mathfrak{a}}_2^{-1} \times \mathfrak{a}_1^{-1} \mathfrak{a}_2^{-1} \mathbf{n} \mid A_1 A_2 (\alpha - \beta) \in \sqrt{D} \mathbb{F}_q[T][\sqrt{D}]\}$$

By calculations analogous to [Gr-Za], II (3.6)-(3.10) the map

$$\begin{aligned} R_N &\longrightarrow M(\mathbf{a}_1, \mathbf{a}_2, \mathbf{n}) \\ \begin{pmatrix} a & b \\ c & d \end{pmatrix} &\longmapsto (\alpha = c\tau_1 \bar{\tau}_2 + d\bar{\tau}_2 - a\tau_1 - b, \beta = c\tau_1 \tau_2 + d\tau_2 - a\tau_1 - b) \end{aligned}$$

is a bijection and $\det \begin{pmatrix} a & b \\ c & d \end{pmatrix} = -A_1 A_2 (N_{L/K}(\alpha) - N_{L/K}(\beta)) D^{-1}$.

For $\lambda \in \mathbb{F}_q[T]$, $\lambda \neq 0$ we get

$$\begin{aligned} & \left\{ \begin{pmatrix} a & b \\ c & d \end{pmatrix} \in R_N, (ad - bc) = (\lambda) \right\} \\ & \simeq \left\{ (\alpha, \beta) \in M(\mathfrak{a}_1, \mathfrak{a}_2, \mathfrak{n}) \mid \left(\frac{-A_1 A_2 (N_{L/K}(\alpha) - N_{L/K}(\beta))}{D} \right) = (\lambda) \right\}. \end{aligned}$$

We set $\mu = N_{L/K}(\beta)/A_1^{-1} A_2^{-1} N \in \mathbb{F}_q[T]$, then $d(\gamma\tau_{A_1}, \tau_{A_2}) = \deg \mu N - \deg \lambda D$. Then it follows that

$$\begin{aligned} & \sum_{\substack{\gamma \in R_N \\ (\det \gamma) = (\lambda)}} \left(\frac{q+1}{2(q-1)} - d(\gamma\tau_{A_1}, \tau_{A_2}) \right) \\ & = \sum_{\mu \in \mathbb{F}_q[T] - \{0\}} \left(\frac{q+1}{2(q-1)} - \deg \mu N + \deg \lambda D \right) \cdot \\ & \quad \#\left\{ (\alpha, \beta) \in M(\mathfrak{a}_1, \mathfrak{a}_2, \mathfrak{n}) \mid \left(\frac{-A_1 A_2 (N_{L/K}(\alpha) - N_{L/K}(\beta))}{D} \right) = (\lambda), \frac{N_{L/K}(\beta)}{A_1^{-1} A_2^{-1} N} = \mu \right\}. \end{aligned}$$

We see that

$$\begin{aligned} & \#\left\{ (\alpha, \beta) \in M(\mathfrak{a}_1, \mathfrak{a}_2, \mathfrak{n}) \mid \left(\frac{-A_1 A_2 (N_{L/K}(\alpha) - N_{L/K}(\beta))}{D} \right) = (\lambda), \frac{N_{L/K}(\beta)}{A_1^{-1} A_2^{-1} N} = \mu \right\} \\ & = \#\left\{ \beta \in \mathfrak{a}_1^{-1} \mathfrak{a}_2^{-1} \mathfrak{n} \mid \frac{N_{L/K}(\beta)}{A_1^{-1} A_2^{-1} N} = \mu \right\} \cdot \\ & \quad \#\left\{ \alpha \in \mathfrak{a}_1^{-1} \overline{\mathfrak{a}_2}^{-1} \mid (-A_1 A_2 (N_{L/K}(\alpha) - N_{L/K}(\beta))) = (\lambda D) \right\} \cdot \\ & \quad \cdot \frac{1}{2} (t(\mu, D) + 1) \\ & = r_{\mathfrak{a}_1^{-1} \mathfrak{a}_2^{-1} \mathfrak{n}, A_1^{-1} A_2^{-1} N}(\mu) \cdot \sum_{\epsilon \in \mathbb{F}_q^*} r_{\mathfrak{a}_1^{-1} \overline{\mathfrak{a}_2}^{-1}, A_1^{-1} A_2^{-1}}(\mu N - \epsilon \lambda D) \cdot \frac{1}{2} (t(\mu, D) + 1). \end{aligned}$$

Now we set $\mathfrak{a}_2 = \overline{\mathfrak{a}_1}^{-1} \overline{\mathfrak{a}_0}^{-1}$ and $A_2 = A_1^{-1} \lambda_0^{-1}$, summing over all classes we get for the first part of the formula in the proposition:

$$\begin{aligned} & \sum_{\substack{A_1, A_2 \in Cl(O_L) \\ A_1 A_2^{-1} = \mathcal{A}}} \sum_{\substack{\gamma \in R_N \\ (\det \gamma) = (\lambda)}} \left(\frac{q+1}{2(q-1)} - d(\gamma\tau_{A_1}, \tau_{A_2}) \right) \\ & = \sum_{\mu \in \mathbb{F}_q[T] - \{0\}} \left(\frac{q+1}{2(q-1)} - \deg \mu N + \deg \lambda D \right) \cdot \\ & \quad \left(\sum_{A_1 \in Cl(O_L)} r_{\mathfrak{a}_1^{-1} \overline{\mathfrak{a}_1} \overline{\mathfrak{a}_0} \mathfrak{n}, \lambda_0 N}(\mu) \right) \cdot \left(\sum_{\epsilon \in \mathbb{F}_q^*} r_{\mathfrak{a}_0, \lambda_0}(\mu N - \epsilon \lambda D) \right) \frac{1}{2} (t(\mu, D) + 1). \end{aligned}$$

Since $\deg D$ is odd we see that

$$r_{\mathfrak{a}_1^{-1}\bar{\mathfrak{a}}_1\bar{\mathfrak{a}}_0\mathfrak{n},\lambda_0N}(\mu) = r_{\mathcal{A}_1^2[\mathfrak{a}_0\bar{\mathfrak{n}}]}((\mu))(\delta_{\lambda_0N\mu} + 1).$$

The class number is odd, and therefore every class is a square. Hence

$$\sum_{\mathcal{A}_1 \in Cl(O_L)} r_{\mathfrak{a}_1^{-1}\bar{\mathfrak{a}}_1\bar{\mathfrak{a}}_0\mathfrak{n},\lambda_0N}(\mu) = \sum_{\mathcal{B} \in Cl(O_L)} r_{\mathcal{B}}((\mu))(\delta_{\lambda_0N\mu} + 1) = \frac{\delta_{\lambda_0N\mu} + 1}{q - 1} \sum_{c|\mu} \left[\frac{D}{c} \right].$$

We use this equation, we change the order of the summation, and we continue with our formula

$$\begin{aligned} & \sum_{\substack{\mathcal{A}_1, \mathcal{A}_2 \in Cl(O_L) \\ \mathcal{A}_1\mathcal{A}_2^{-1} = \mathcal{A}}} \sum_{\substack{\gamma \in R_N \\ (\det \gamma) = (\lambda)}} \left(\frac{q + 1}{2(q - 1)} - d(\gamma\tau_{\mathcal{A}_1}, \tau_{\mathcal{A}_2}) \right) \\ &= \sum_{\epsilon \in \mathbb{F}_q^*} \sum_{\mu \in \mathbb{F}_q[T] - \{0\}} \left(\frac{q + 1}{2(q - 1)} - \deg \mu N + \deg \lambda D \right) \cdot \\ & \quad \frac{1}{q - 1} \left(\sum_{c|\mu} \left[\frac{D}{c} \right] \right) (\delta_{\lambda_0N\epsilon\mu} + 1) r_{\mathfrak{a}_0,\lambda_0}(\epsilon(\mu N - \lambda D)) \frac{1}{2}(t(\mu, D) + 1). \end{aligned}$$

If $r_{\mathfrak{a}_0,\lambda_0}(\epsilon(\mu N - \lambda D)) \neq 0$, then $\lambda_0\epsilon(\mu N - \lambda D)$ is a norm and $\delta_{\lambda_0N\epsilon\mu} = \delta_{\mu N(\mu N - \lambda D)}$. In addition we use the relation

$$\sum_{\epsilon \in \mathbb{F}_q^*} r_{\mathfrak{a}_0,\lambda_0}(\epsilon(\mu N - \lambda D)) = (q - 1)r_{\mathcal{A}}((\mu N - \lambda D)).$$

This proves the first part of the formula in the proposition. The same calculations hold with $q^{-d(\gamma\tau_{\mathcal{A}_1}, \tau_{\mathcal{A}_2})s}$ instead of $d(\gamma\tau_{\mathcal{A}_1}, \tau_{\mathcal{A}_2})$. If $\deg \mu N > \deg \lambda D$ we have $\delta_{\mu N(\mu N - \lambda D)} = 1$. Therefore the second part of the formula is also true. \square

Now we continue with the calculation of the function $F_2(\mathcal{A}, s)$ defined in equation (3.5.2).

PROPOSITION 3.5.2 *For the function $F_2(\mathcal{A}, s)$ the following formula holds*

$$\begin{aligned} & \lim_{s \rightarrow 1} \left[F_2(\mathcal{A}, s) - \frac{4\kappa h_L \sigma_1(\lambda)}{1 - q^{1-s}} \right] \\ &= C \left(\sum_{a|\lambda} q^{\deg a} \right) + 2\kappa h_L \sum_{a|\lambda} (\deg \lambda - 2 \deg a) q^{\deg a} \end{aligned}$$

with

$$\begin{aligned} C := & -4\kappa h_L \left(\deg N - \sum_{\substack{(P)|(N) \\ (P) \text{ prime}}} \deg P (1 + q^{\deg P})^{-1} \right. \\ & \left. - \frac{\deg D}{2} - \frac{2}{q - 1} - \frac{1}{\ln q} \frac{L'_D(1)}{L_D(1)} \right). \end{aligned}$$

PROOF. $Ei_s^{(N)}(\tau)$ is invariant under the non trivial automorphism of L/K . From $\bar{\tau}_{\mathcal{A},n} = \tau_{\mathcal{A}^{-1},\bar{n}}$ and $1/(N\tau_{\mathcal{A}_1,n}) = \tau_{\mathcal{A}_1[n],\bar{n}}$ it follows that

$$\sum_{\mathcal{A} \in Cl(O_L)} Ei_s^{(N)}\left(\frac{1}{N\tau_{\mathcal{A}}}\right) = \sum_{\mathcal{A} \in Cl(O_L)} Ei_s^{(N)}(\tau_{\mathcal{A}}).$$

$Ei_s^{(N)}$ can be expressed through the Eisenstein series $Ei^{(1)}$ by (cf. Lemma 7, [Ti3])

$$Ei_s^{(N)}(\tau_{\mathcal{A}}) = |N|^{-s} \prod_{\substack{(P)|(N) \\ (P) \text{ prime}}} (1 - |P|^{-2s})^{-1} \left(\sum_{\substack{\delta|N \\ \delta \bmod \mathbb{F}_q^*}} \mu(\delta)|\delta|^{-s} \right) Ei_s^{(1)}\left(\frac{N}{\delta}\tau_{\mathcal{A}}\right).$$

$(N/\delta)\tau_{\mathcal{A}}$ are Heegner points for δ instead of N with the same discriminant. Immediately from the definitions we get

$$Ei_s^{(1)}(\tau) = (1 - q^{1-2s})|\sqrt{D}|^s \zeta_L(\mathcal{A}, s)$$

where $\zeta_L(\mathcal{A}, s)$ is the partial ζ -function to the class \mathcal{A} . This yields

$$\begin{aligned} & \sum_{\mathcal{A} \in Cl(O_L)} Ei_s^{(N)}(\tau_{\mathcal{A}}) \\ &= |N|^{-s} \prod_{\substack{(P)|(N) \\ (P) \text{ prime}}} (1 - |P|^{-2s})^{-1} \left(\sum_{\substack{\delta|N \\ \delta \bmod \mathbb{F}_q^*}} \mu(\delta)|\delta|^{-s} \right) \\ & \quad (1 - q^{1-2s})|\sqrt{D}|^s \sum_{\mathcal{A}} \zeta_L(\mathcal{A}, s). \end{aligned}$$

We have $\sum_{\mathcal{A}} \zeta_L(\mathcal{A}, s) = \zeta_L(s)(1 - q^{-s}) = L_D(s)/(1 - q^{1-s})$. This gives

$$\begin{aligned} F_2(\mathcal{A}, s) &= |N|^{-s} \prod_{\substack{P|N \\ P \bmod \mathbb{F}_q^*}} (1 + |P|^{-s})^{-1} q^{1/2}(q + 1) \frac{1 - q^{1-2s}}{1 - q^{1-s}} \\ & \quad \cdot |\sqrt{D}|^s L_D(s)(\sigma_1(\lambda) + |\lambda|^s \sigma_{1-2s}(\lambda)). \end{aligned}$$

Now a straightforward calculation gives the desired result. □

3.5.2 DEG D EVEN

For the case where the degree of D is even we proceed in almost the same way as for the case of odd degree, so we only need mention here the statements and the differences in the proofs.

We start again with the general formula for the local height pairing at infinity

for two points given by $z, z' \in \Omega$ of [Ti3] (Thm.1, Prop. 8,9):

$$\begin{aligned} & \langle (z) - (\infty), (z') - (0) \rangle_{L_\infty} \\ &= \frac{-2 \ln q}{q-1} \left[\sum_{\substack{\gamma \in \Gamma \\ d(\gamma z, z') \leq 0}} \left(\frac{q}{q^2-1} - \frac{1}{2} d(\gamma z, z') \right) \right. \\ & \quad \left. + \lim_{s \rightarrow 1} \left[\frac{q}{q^2-1} \sum_{\substack{\gamma \in \Gamma \\ d(\gamma z, z') > 0}} q^{-d(\gamma z, z')s} - \frac{\kappa(q-1)}{1-q^{1-s}} \right] \right. \\ & \quad \left. - \lim_{s \rightarrow 1} \left[q(q-1)(Ei_s^{(N)}(z') + Ei_s^{(N)}\left(\frac{1}{Nz}\right)) - \frac{2\kappa(q-1)}{1-q^{1-s}} \right] \right]. \end{aligned}$$

Again we take $\tau_{\mathcal{A}_j} \in \Omega$ to be elements corresponding to the different ideal classes \mathcal{A}_j . If τ is one of these $\tau_{\mathcal{A}_j}$ we get

$$\begin{aligned} & \langle (\tau) - (\infty), T_\lambda((\tau)^{\sigma_{\mathcal{A}}} - (0)) \rangle_\infty \\ &= \frac{-\ln q}{q-1} \left[\lim_{s \rightarrow 1} \left[F_1(\mathcal{A}, s) - \frac{2\kappa h_L \sigma_1(\lambda)}{1-q^{1-s}} \right] \right. \\ & \quad \left. - \lim_{s \rightarrow 1} \left[F_2(\mathcal{A}, s) - \frac{4\kappa h_L \sigma_1(\lambda)}{1-q^{1-s}} \right] \right] \end{aligned}$$

with $\kappa := \frac{q^2-1}{2[GL_2(\mathbb{F}_q[T]) : \Gamma_0(N)]}$ as above and the modified functions F_1, F_2

$$\begin{aligned} F_1(\mathcal{A}, s) &:= \sum_{\substack{\mathcal{A}_1, \mathcal{A}_2 \in Cl(O_L) \\ \mathcal{A}_1 \mathcal{A}_2^{-1} = \mathcal{A}}} \left[\sum_{\substack{\gamma \in R_N, (\det \gamma) = (\lambda) \\ d(\gamma \tau_{\mathcal{A}_1}, \tau_{\mathcal{A}_2}) \leq 0}} \left(\frac{2q}{q^2-1} - d(\gamma \tau_{\mathcal{A}_1}, \tau_{\mathcal{A}_2}) \right) \right. \\ & \quad \left. + \frac{2q}{q^2-1} \sum_{\substack{\gamma \in R_N, (\det \gamma) = (\lambda) \\ d(\gamma \tau_{\mathcal{A}_1}, \tau_{\mathcal{A}_2}) > 0}} q^{-d(\gamma \tau_{\mathcal{A}_1}, \tau_{\mathcal{A}_2})s} \right] \end{aligned}$$

and

$$F_2(\mathcal{A}, s) := \sum_{\substack{\mathcal{A}_1, \mathcal{A}_2 \in Cl(O_L) \\ \mathcal{A}_1 \mathcal{A}_2^{-1} = \mathcal{A}}} q \left[q^{\deg \lambda s} \sigma_{1-2s}(\lambda) Ei_s^{(N)}(\tau_{\mathcal{A}_2}) + \sigma_1(\lambda) Ei_s^{(N)}\left(\frac{1}{N\tau_{\mathcal{A}_1}}\right) \right].$$

With these definitions we get:

PROPOSITION 3.5.3 *The following equation for F_1 holds*

$$\begin{aligned}
 F_1(\mathcal{A}, s) = & \sum_{\substack{\mu \neq 0 \\ \deg(\mu N) \leq \deg(\lambda D)}} r_{\mathcal{A}}((\mu N - \lambda D)) \left(\sum_{c|\mu} \left[\frac{D}{c} \right] \right) (t(\mu, D) + 1) \\
 & \cdot \frac{1 + \delta_{(\mu N - \lambda D)N\mu}}{2} \left(-\deg \mu N + \deg \lambda D + \frac{2q}{q^2 - 1} \right) \\
 & + \frac{2q}{q^2 - 1} \sum_{\substack{\mu \in \mathbb{F}_q^{[T]-\{0\}} \\ \deg \mu N > \deg \lambda D}} r_{\mathcal{A}}((\mu N - \lambda D)) \left(\sum_{c|\mu} \left[\frac{D}{c} \right] \right) \\
 & \cdot (t(\mu, D) + 1) q^{-(\deg \mu N - \deg \lambda D)s}.
 \end{aligned}$$

PROOF. The proof of this proposition differs from the corresponding Proposition 3.5.1 only slightly. We start with

$$\begin{aligned}
 & \sum_{\mu \neq 0} \left(\frac{2q}{q^2 - 1} - \deg \mu N + \deg \lambda D \right) r_{\mathcal{A}}((\mu N - \lambda D)) \cdot \\
 & \left(\sum_{c|\mu} \left[\frac{D}{c} \right] \right) (\delta_{\mu N(\mu N - \lambda D)} + 1) \frac{1}{2} (t(\mu, D) + 1).
 \end{aligned}$$

Since D is irreducible with even degree, the ideal class number is divisible by 2 exactly once. Hence the set $\{\mathcal{A}^2 | \mathcal{A} \in Cl(O_L)\}$ is equal to the set

$$\{\mathcal{B} \in Cl(O_L) | \deg N_{L/K}(\mathfrak{b}) \text{ is even for all } \mathfrak{b} \in \mathcal{B}\}.$$

This yields:

$$\begin{aligned}
 \sum_{\mathcal{A}_1 \in Cl(O_L)} r_{\mathcal{A}_1^2[\bar{\mathfrak{a}}_0 \mathfrak{n}]}((\mu)) &= \sum_{\mathcal{B} \in Cl(O_L)} r_{\mathcal{B}}((\mu)) (\delta_{\lambda_0 N \mu} + 1) \\
 &= \frac{1}{q - 1} \left(\sum_{c|\mu} \left[\frac{D}{c} \right] \right) (\delta_{\lambda_0 N \mu} + 1).
 \end{aligned}$$

Using similar arguments as in Proposition 3.5.1 we get for our first sum:

$$\begin{aligned}
 \sum_{\mu \neq 0} \left(\frac{2q}{q^2 - 1} - \deg \mu N + \deg \lambda D \right) & \left(\sum_{\mathcal{A}_1 \in Cl(O_L)} \frac{1}{q - 1} \sum_{\epsilon_1 \in \mathbb{F}_q^*} r_{\mathfrak{a}_1^{-1} \bar{\mathfrak{a}}_1 \bar{\mathfrak{a}}_0 \mathfrak{n}, \lambda_0 N}(\epsilon_1 \mu) \right) \\
 & \cdot \left(\sum_{\epsilon \in \mathbb{F}_q^*} r_{\mathfrak{a}_0, \lambda_0}(\mu N - \epsilon \lambda D) \right) \frac{1}{2} (t(\mu, D) + 1).
 \end{aligned}$$

Each $\epsilon_1 \in \mathbb{F}_q^*$ is norm at the extension L/K , i.e., $\epsilon_1 = N_{L/K}(\kappa)$. The divisor of κ is of the form $(\kappa) = \mathfrak{b}^{-1} \bar{\mathfrak{b}}$. This proves

$$r_{\mathfrak{a}_1^{-1} \bar{\mathfrak{a}}_1 \bar{\mathfrak{a}}_0 \mathfrak{n}, \lambda_0 N}(\mu) = r_{(\mathfrak{a}_1 \mathfrak{b})^{-1} \overline{\mathfrak{a}_1 \bar{\mathfrak{b}} \bar{\mathfrak{a}}_0 \mathfrak{n}}, \lambda_0 N}(\epsilon_1 \mu).$$

Therefore an appropriate choice of the ideals \mathfrak{a}_1 yields for our sum:

$$\sum_{\mu \neq 0} \left(\frac{2q}{q^2 - 1} - \deg \mu N + \deg \lambda D \right) \left(\sum_{\mathcal{A}_1 \in Cl(O_L)} r_{\mathfrak{a}_1^{-1} \bar{\mathfrak{a}}_1 \bar{\mathfrak{a}}_0 n, \lambda_0 N}(\mu) \right) \cdot \left(\sum_{\epsilon \in \mathbb{F}_q^*} r_{\mathfrak{a}_0, \lambda_0}(\mu N - \epsilon \lambda D) \right) \frac{1}{2} (t(\mu, D) + 1).$$

The rest follows in the same way as in the proof of Proposition 3.5.1. \square
 The formula for $F_2(\mathcal{A}, s)$ can be calculated in exactly the same way, so we only write down the result.

PROPOSITION 3.5.4 *For the function $F_2(\mathcal{A}, s)$ the following formula holds*

$$\lim_{s \rightarrow 1} \left[F_2(\mathcal{A}, s) - \frac{4\kappa h_L \sigma_1(\lambda)}{1 - q^{1-s}} \right] = C \left(\sum_{a|\lambda} q^{\deg a} \right) + 2\kappa h_L \sum_{a|\lambda} (\deg \lambda - 2 \deg a) q^{\deg a}$$

with

$$C := -4\kappa h_L \left(\deg N - \sum_{\substack{(P)|(N) \\ (P) \text{ prime}}} \deg P (1 + q^{\deg P})^{-1} - \frac{\deg D}{2} - \frac{q + 3}{q^2 - 1} - \frac{1}{\ln q} \frac{L'_D(1)}{L_D(1)} \right).$$

3.6 MODIFICATION IF $r_{\mathcal{A}}((\lambda)) \neq 0$

So far we have only evaluated heights and intersection numbers, when the divisors involved have a disjoint support. In order to get a final result we must also define and compute self-intersection numbers.

Let X be a complete, non-singular, irreducible curve defined over a global function field F over \mathbb{F}_q , and let x be a F -rational point on X . Let \mathcal{X} be a regular model of X over \mathbb{P}_F^1 . We call l_x a *local parameter at x* if l_x generates the prime ideal corresponding to x in the local ring at x in the generic fibre. Let \tilde{x} be the Zariski closure of x in \mathcal{X} . If π is a local parameter of a fibre corresponding to a valuation v , we call l_x a *local parameter at x for the valuation v* , if l_x together with π generate the maximal ideal corresponding to the intersection point of \tilde{x} with the fibre over v . Now fix a local parameter l_x at x . Then we define for each normalized valuation v of F the local self-intersection number of x as

$$(x \cdot x)_v := \lim_{y \rightarrow x} ((x \cdot y)_v - v(l_x(y))) = \lim_{y \rightarrow x} ((x \cdot y)_v + \frac{1}{\deg v} \log_q |l_x(y)|_v), \tag{3.6.1}$$

where $\deg v$ is defined as usual, and where the absolute value is given by $|\alpha|_v := q^{-\deg v \cdot v(\alpha)}$, according to the product formula of the function field F .

The definition (3.6.1) and the definition of the ordinary intersection number $(x \cdot y)_v$ (cf. section 3.1) show immediately that $(x \cdot x)_v = 0$, if l_x is a local parameter at x for the valuation v .

In the next step we have to choose the local parameter l_x in our situation. The curve $X_0(1)$ is the projective line parametrized by the j -invariant of a Drinfeld module of rank 2. We recall that a Drinfeld module of rank 2 over $\mathbb{F}_q[T]$ is given by an additive polynomial $\Phi_T(X) = TX + gX^q + \Delta X^{q^2}$ with discriminant Δ and j -invariant $j = g^{q+1}/\Delta$.

We let Y_1 be the projective line given by the parameter u with $u^{q+1} = j$. Then $Y_1/X_0(1)$ is an extension of degree $q + 1$, where only the elliptic points and cusps (i.e. zeroes and poles of j) are ramified (These facts and the definition of elliptic points can be found in [Ge1] or in other textbooks on Drinfeld modules). Let Y_N be the composite of Y_1 and $X_0(N)$, we get the following diagram:

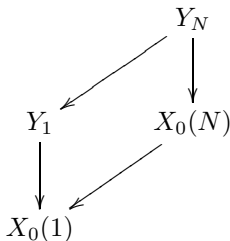

On Y_N we choose for a point y the local parameter $l_y := u - u(y)$. The self-intersection numbers on $X_0(N)$ will then be evaluated with this local parameter on Y_N and with the projection formula for the extension $Y_N/X_0(N)$.

We distinguish different cases for the valuations v :

3.6.1 $v \nmid N \cdot \infty$

Let x be a Heegner point on $X_0(N)$, defined locally over W as in section 3.1, and let y_1, \dots, y_t be the points on Y_N lying over x . Then the projection formula yields

$$(x \cdot x)_v = (y_1 \cdot y_1)_v + (y_1 \cdot y_2)_v + \dots + (y_1 \cdot y_t)_v.$$

Since the covering $Y_N/X_0(N)$ is unramified outside the elliptic points and cusps and outside the divisors of $N \cdot \infty$, we see that $u - u(y_1)$ is a local parameter of y_1 at v . Hence $(y_1 \cdot y_1)_v = 0$ by the above remark. Since

$$(y_1 \cdot y_j)_v = \frac{1}{q-1} \sum_{k=1}^{\infty} \#\text{Isom}_{W/\pi^k}(y_1, y_j)$$

for $j \neq 1$ (Proposition 3.3.3), we therefore get

$$(x \cdot x)_v = \frac{1}{q-1} \sum_{k=1}^{\infty} (\#\text{Aut}_{W/\pi^k}(x) - \#\text{Aut}_W(x)). \tag{3.6.2}$$

As mentioned at the end of the proof of Proposition 3.4.3 the automorphisms not defined over W correspond to the elements $b \in R\mathfrak{a}$, $b = b_1 + b_2j$ with $b_2 \neq 0$ which corresponds to $\mu \neq 0$ in the formulae of Corollary 3.4.10 and Proposition 3.4.13. So these formulae already count only the “new” part, i.e. without counting homomorphisms over W . Thus if $\lambda \in \mathbb{F}_q[T]$ is prime to P the formulae for the local height pairings $\langle (x) - (\infty), T_\lambda(x)^{\sigma_A} - (0) \rangle_P$ of Corollary 3.4.10 and Proposition 3.4.13 remain valid. This is not true however, if $v|\lambda$. We write as before $\lambda = P^t R$ with $P \nmid R$. For the points of level $s > 0$ it is not correct to take only the “new” part. So we have to add the contribution from homomorphisms over W for these points to the formulae of Corollary 3.4.10 and Proposition 3.4.13.

For P inert we look at the last line of (3.3.1) We get a contribution of

$$\frac{1}{q-1} \begin{cases} \frac{t}{2} \# \text{Isom}_W(z, x) \# \{z \in T_R x^{\sigma_A}\} & \text{if } t \text{ is even} \\ \frac{t+1}{2} \# \text{Hom}_W(z, x)_{\deg P} \# \{z \in T_R x^{\sigma_A}\} & \text{if } t \text{ is odd} \end{cases}$$

which is $(t/2)r_1((P^t)r_A((R)))$ if t is even and 0 if t is odd. In both cases this is equal to $(\text{ord}_P(\lambda)/2)r_A((\lambda))$.

If P is ramified we get in a similar way from (3.3.2) a contribution of $\text{ord}_P(\lambda)r_A((\lambda))$.

If P is split we have $t + 1$ points of level 0 in $T_\lambda x^{\sigma_A}$, where x is just one of them (cf. Proposition 3.2.4). From the $t - s + 1$ divisors of points of level $s > 0$ there is at most one whose points are congruent to x . Summing over all levels shows that the correction term in this case is $\text{ord}_P(\lambda)r_A((\lambda))k_{\mathfrak{p}}$, where $k_{\mathfrak{p}}$ is a number less or equal to t , and $k_{\mathfrak{p}} + k_{\overline{\mathfrak{p}}} = \text{ord}_P(\lambda)$.

3.6.2 $v|N$

Let x be a Heegner point on $X_0(N)$ represented by the pair of ideals $(\mathfrak{a}, \mathfrak{a}\mathfrak{n}^{-1})$, where \mathfrak{n} is a divisor of N in L (cf. section 3.1).

a) Suppose that $v|\mathfrak{n}$, in particular let v divide the prime divisor \mathfrak{p} of norm $N_{L/K}(\mathfrak{p})$. The Artin reciprocity law in explicit class field theory ([Ha, (8.7)]) uses the fundamental congruence

$$j(\mathfrak{a}\mathfrak{p}^{-1}) \equiv j(\mathfrak{a})^{N_{L/K}(\mathfrak{p})} \pmod{v}.$$

From this we see that $u - u(y_1)$ is again a local parameter of y_1 at v for a point y_1 on Y_N lying over x . Hence the calculations of the previous section, in particular equation (3.6.2), remain true in this situation.

b) Suppose that $v|\overline{\mathfrak{n}}$. Then the calculations of a) show that $w_N(u - u(y_1))$ is a local parameter of y_1 at v , where w_N denotes the canonical involution on $X_0(N)$ and Y_N . Hence

$$(y_1 \cdot y_1)_v = v\left(\frac{\partial w_N(u)}{\partial u}(u(y_1))\right). \tag{3.6.3}$$

Using the fact that $u^{q+1} = j$ we get

$$\left(\frac{\partial w_N(u)}{\partial u}\right)^{q+1} = \left(\frac{\partial w_N(j)}{\partial j}\right)^{q+1} \left(\frac{j}{w_N(j)}\right)^q. \quad (3.6.4)$$

If the Heegner point x is represented by $\tau \in \Omega$, then $w_N(j)(\tau) = j(N\tau)$. And we can evaluate the right hand side of (3.6.4) with $\frac{\partial w_N(j)}{\partial z}(\tau)$ and $\frac{\partial j}{\partial z}(\tau)$. For $\frac{\partial j}{\partial z}$ we use the definition $j = g^{q+1}/\Delta$ and get

$$\frac{\partial j}{\partial z} = \frac{g^q}{\Delta^2} \left(\frac{\partial g}{\partial z} \Delta - g \frac{\partial \Delta}{\partial z} \right).$$

$\frac{\partial g}{\partial z} \Delta - g \frac{\partial \Delta}{\partial z}$ can be expressed in terms of Δ (cf. equation (3.6.11)). For $\frac{\partial w_N(j)}{\partial z}$ we perform similar calculations. Hence we get

$$\left(\frac{\partial w_N(u)}{\partial u}(u(y_1))\right)^{q^2-1} = N^{q^2-1} \left(\frac{\Delta(N\tau)}{\Delta(\tau)}\right)^2. \quad (3.6.5)$$

$\Delta(\tau)/\Delta(N\tau)$ is algebraic over L and its divisor is equal to $\bar{\mathfrak{n}}^{q^2-1}$ (we get this by calculations analogous to those in [Deu], sect. 13). With this fact and with (3.6.5) we can evaluate the value in (3.6.3). Together we get

LEMMA 3.6.1 *If $v|\mathfrak{n}$, then*

$$(x \cdot x)_v = 0,$$

and if $v|\bar{\mathfrak{n}}$, then

$$(x \cdot x)_v = -v(N) = -1.$$

We can now summarize the results of the first two cases. We want to evaluate the height of Heegner points as in section 3.4, but without any restriction on $r_{\mathcal{A}}((\lambda))$. We combine the calculations in section 3.4 with the contributions from subsection 3.6.1 and Lemma 3.6.1, and we get

PROPOSITION 3.6.2

$$\begin{aligned} \sum_{P \neq \infty} \langle (x) - (\infty), T_{\lambda}((x)^{\sigma_{\mathcal{A}}} - (0)) \rangle_P &= \frac{\ln q}{q-1} \\ &\cdot \left\{ (q-1) r_{\mathcal{A}}((\lambda)) h_L(\deg N - \deg \lambda) \right. \\ &+ \sum_{\substack{\mu \neq 0 \\ \deg(\mu N) \leq \deg(\lambda D)}} r_{\mathcal{A}}((\mu N - \lambda D)) (1 - \delta_{(\mu N - \lambda D)\mu N}) \\ &\left. \cdot \left((t(\mu, D) + 1) \left(\sum_{c|\mu} \left[\frac{D}{c} \right] \deg c \right) - \left(\sum_{c|\mu} \left[\frac{D}{c} \right] \right) \deg \mu \right) \right\}. \end{aligned}$$

3.6.3 $v|\infty$

Let x be a Heegner point on $X_0(N)$ represented by $\tau \in \Omega$, and let y_1, \dots, y_t be the points on Y_N lying over x . As above the projection formula yields

$$(x \cdot x)_v = (y_1 \cdot y_1)_v + (y_1 \cdot y_2)_v + \dots + (y_1 \cdot y_t)_v.$$

The self-intersection number on Y_N is by definition given as

$$(y_1 \cdot y_1)_v := \lim_{\tilde{y} \rightarrow y_1} ((y_1 \cdot \tilde{y})_v - v(u(\tilde{y}) - u(y_1))).$$

Therefore, if \tilde{y} on Y_N is mapped to \tilde{x} on $X_0(N)$, we get

$$(x \cdot x)_v := \lim_{\tilde{x} \rightarrow x} ((x \cdot \tilde{x})_v - v(u(\tilde{y}) - u(y_1))). \tag{3.6.6}$$

The point x is represented by $\tau \in \Omega$, let in addition \tilde{x} be represented by $\tilde{\tau} \in \Omega$. At first we treat the case where $\deg D$ is odd. The local height pairing of x and \tilde{x} at v is given by the Green's function $G(\tilde{\tau}, \tau)$ ([Ti3], cf. also section 3.5):

$$\begin{aligned} G(\tilde{\tau}, \tau) &= \frac{1}{q-1} \sum_{\substack{\gamma \in \Gamma_0(N) \\ |\tau - \gamma\tilde{\tau}|^2 \leq |\tau|_i |\gamma\tilde{\tau}|_i}} \left(\frac{q+1}{2(q-1)} - \log_q \frac{|\tau - \gamma\tilde{\tau}|^2}{|\tau|_i |\gamma\tilde{\tau}|_i} \right) \\ &+ \frac{q+1}{2(q-1)^2} \lim_{\sigma \rightarrow 1} \left(\sum_{\substack{\gamma \in \Gamma_0(N) \\ |\tau - \gamma\tilde{\tau}|^2 > |\tau|_i |\gamma\tilde{\tau}|_i}} \left(\frac{|\tau - \gamma\tilde{\tau}|^2}{|\tau|_i |\gamma\tilde{\tau}|_i} \right)^{-\sigma} - \frac{C_1}{1 - q^{1-\sigma}} \right), \end{aligned} \tag{3.6.7}$$

where we normalize the absolute value such that $|f| = q^{\deg f} = q^{-v(f)}$ for $f \in \mathbb{F}_q[T]$.

The Green's function $G(\tilde{\tau}, \tau)$ contains two parts, the intersection number $(\tilde{x} \cdot x)_v$ and the contribution of the fibre components (cf. (3.1.1)). We must replace $(\tilde{x} \cdot x)_v$ by the self intersection number $(x \cdot x)_v$. The contribution of the fibre components remains unchanged.

We have $u^{q+1} = j$ and $j = j(z)$ for $z \in \Omega$, this yields

$$\lim_{\tilde{y} \rightarrow y_1} (v(u(\tilde{y}) - u(y_1))) = v\left(\frac{\partial u}{\partial \tau}\right) + \lim_{\tilde{\tau} \rightarrow \tau} (v(\tilde{\tau} - \tau)). \tag{3.6.8}$$

Here $\frac{\partial u}{\partial \tau}$ only represents the two derivatives $\frac{\partial u}{\partial j}$ and $\frac{\partial j}{\partial \tau}$, we do not assume that Y_N is a quotient of Ω .

Now (3.6.6), (3.6.7) and (3.6.8) show that we have to replace $G(\tilde{\tau}, \tau)$ by

$$\begin{aligned} G(\tau, \tau) &:= \frac{1}{q-1} \sum_{\substack{\gamma \in \Gamma_0(N), \gamma\tau \neq \tau \\ |\tau - \gamma\tau|^2 \leq |\tau|_i |\gamma\tau|_i}} \left(\frac{q+1}{2(q-1)} - \log_q \frac{|\tau - \gamma\tau|^2}{|\tau|_i |\gamma\tau|_i} \right) \\ &+ \frac{q+1}{2(q-1)^2} \lim_{\sigma \rightarrow 1} \left(\sum_{\substack{\gamma \in \Gamma_0(N) \\ |\tau - \gamma\tau|^2 > |\tau|_i |\gamma\tau|_i}} \left(\frac{|\tau - \gamma\tau|^2}{|\tau|_i |\gamma\tau|_i} \right)^{-\sigma} - \frac{C_1}{1 - q^{1-\sigma}} \right) \\ &+ \frac{q+1}{2(q-1)} + 2 \log_q \left(|\tau|_i \left| \frac{\partial u}{\partial \tau} \right| \right), \end{aligned}$$

When we compare the results in section 3.5 with these formulas, we get

$$\langle (x) - (\infty), T_\lambda((x)^{\sigma_A} - (0)) \rangle_\infty = \text{right hand side of eq. (3.5.1)} \\ -2 \ln q r_{\mathcal{A}}((\lambda)) \sum_{\tau} \left(\log_q(|\tau|_i \left| \frac{\partial u}{\partial \tau} \right|) + \frac{q+1}{4(q-1)} \right), \quad (3.6.9)$$

where we sum over all τ corresponding to the classes in O_L . We denote the second sum in (3.6.9) by S , which we will evaluate now.

We use the definitions $u^{q+1} = j$ and $j = g^{q+1}/\Delta$ to evaluate

$$\left(\frac{\partial u}{\partial z} \right)^{q^2-1} = \Delta^{2-q^2-q} \left(\frac{\partial g}{\partial z} \Delta - g \frac{\partial \Delta}{\partial z} \right)^{q^2-1}. \quad (3.6.10)$$

$\left(\frac{\partial g}{\partial z} \Delta - g \frac{\partial \Delta}{\partial z} \right)^{q-1}$ is a modular form of weight $q(q^2 - 1)$ for the group $GL_2(\mathbb{F}_q[T])$, and it is therefore a polynomial in g and Δ (cf. [Go]). The evaluation of the expansion around the cusp yields the identity

$$\left(\frac{\partial g}{\partial z} \Delta - g \frac{\partial \Delta}{\partial z} \right)^{q-1} = -\bar{\pi}^{1-q} \Delta^q, \quad (3.6.11)$$

where $\bar{\pi}$ is a well-defined element (cf. [Ge3]) with $\log_q |\bar{\pi}| = q/(q-1)$.

Now (3.6.10) and (3.6.11) yield

$$\log_q \left(|\tau|_i \left| \frac{\partial u}{\partial \tau} \right| \right) = \log_q (|\Delta(\tau)|^{2/(q^2-1)} |\tau|_i) - \frac{q}{q-1}.$$

Since $|\Delta(\tau)|^{2/(q^2-1)} |\tau|_i$ is invariant under $GL_2(\mathbb{F}_q[T])$, we can assume that τ satisfies $|\tau| = |\tau|_i > 1$. For these τ we use the product formula for Δ (for all the details concerning the product formula we refer to [Ge3]):

$$\Delta(\tau) = -\bar{\pi}^{q^2-1} t(\tau)^{q-1} \prod_{\substack{a \in \mathbb{F}_q[T] \\ \text{monic}}} f_a(t(\tau))^{(q^2-1)(q-1)},$$

where

$$t(\tau) = (\bar{\pi} \tau \prod_{\substack{l \in \mathbb{F}_q[T] \\ l \neq 0}} (1 - \frac{\tau}{l}))^{-1},$$

and where f_a are well-defined polynomials. Using the definitions of f_a and $t(\tau)$ we can show that in our case (i.e. $\tau \in K_\infty(\sqrt{D})$, $\deg D$ odd, $|\tau| = |\tau|_i > 1$)

$$\log_q |t(\tau)| = -|\tau|_i q^{1/2} \frac{q+1}{2(q-1)}$$

and

$$\log_q |f_a(t(\tau))| = 0.$$

Therefore

$$\log_q |\Delta(\tau)| = q(q+1) - \frac{1}{2} q^{1/2} (q+1) |\tau|_i. \quad (3.6.12)$$

Hence we get

$$\log_q(|\tau|_i \left| \frac{\partial u}{\partial \tau} \right|) = \frac{q}{q-1} - \frac{q^{1/2}}{q-1} |\tau|_i + \log_q |\tau|_i. \tag{3.6.13}$$

Now the definition of S in (3.6.9) and equation (3.6.13) yield

$$S = -2 \ln q r_{\mathcal{A}}((\lambda)) \left(\frac{5q+1}{4(q-1)} h_L + \sum_{\tau} \left(-\frac{q^{1/2} |\tau|_i}{q-1} + \log_q |\tau|_i \right) \right). \tag{3.6.14}$$

On the other hand we consider the Eisenstein series

$$Ei_s(\tau) := \sum_{\substack{c,d \in \mathbb{F}_q[T] \\ (c,d) \neq (0,0)}} \frac{|\tau|_i^s}{|c\tau + d|^{2s}}. \tag{3.6.15}$$

We see that

$$\sum_{\tau} Ei_s(\tau) = \frac{(q-1) |\sqrt{D}|^s}{1 - q^{1-s}} L_D(s), \tag{3.6.16}$$

where $L_D(s)$ again is the non-trivial L -series of the extension L/K . Straight-forward calculations of the sum in (3.6.15) show that $Ei_s(\tau)$ can be expressed as a rational function:

$$Ei_s(\tau) = (q-1) \frac{|\tau|_i^s}{1 - q^{1-2s}} + \frac{q^{1/2} |\tau|_i^{1-s}}{1 - q^{2-2s}} \left((q-1)^2 \frac{q^{-s}}{1 - q^{1-2s}} + q - 1 \right). \tag{3.6.17}$$

With (3.6.16) and (3.6.17) we can evaluate the following term

$$\frac{2}{\ln q} \frac{L'_D(0)}{L_D(0)} = -\deg D + \frac{2q}{q-1} - \frac{2}{h_L} \sum_{\tau} \left(\frac{q^{1/2} |\tau|_i}{q-1} - \log_q |\tau|_i \right). \tag{3.6.18}$$

We compare equation (3.6.14) coming from values of Δ and equation (3.6.18) dealing with Eisenstein series, to get

$$S = \ln q r_{\mathcal{A}}((\lambda)) h_L \left(-\deg D - \frac{2}{\ln q} \frac{L'_D(0)}{L_D(0)} - \frac{q+1}{2(q-1)} \right). \tag{3.6.19}$$

This result can be seen as the Kronecker limit formula for function fields. We summarize Propositions 3.5.1 and 3.5.2 and the result (3.6.9), (3.6.19) about S in the following proposition.

PROPOSITION 3.6.3 *Let deg D be odd, then*

$$\begin{aligned} & \langle (x) - (\infty), T_\lambda((x)^{\sigma_A} - (0)) \rangle_\infty = \frac{\ln q}{q-1} \\ & \cdot \left\{ (q-1) r_{\mathcal{A}}((\lambda)) h_L \left(-\deg D - \frac{q+1}{2(q-1)} - \frac{2}{\ln q} \frac{L'_D(0)}{L_D(0)} \right) \right. \\ + & \sum_{\substack{\mu \neq 0 \\ \deg(\mu N) \leq \deg(\lambda D)}} r_{\mathcal{A}}((\mu N - \lambda D)) \left(\sum_{c|\mu} \left[\frac{D}{c} \right] \right) (t(\mu, D) + 1) \frac{1 + \delta_{(\mu N - \lambda D)\mu N}}{2} \\ & \cdot \left(\deg\left(\frac{\mu N}{\lambda D}\right) - \frac{q+1}{2(q-1)} \right) \\ - & \frac{q+1}{2(q-1)} \lim_{\sigma \rightarrow 0} \left(\sum_{\deg(\mu N) > \deg(\lambda D)} r_{\mathcal{A}}((\mu N - \lambda D)) \left(\sum_{c|\mu} \left[\frac{D}{c} \right] \right) (t(\mu, D) + 1) \right. \\ & \cdot \left. q^{(-\sigma-1)\deg(\frac{\mu N}{\lambda D})} - \frac{C_1 h_L(\sum_{a|\lambda} q^{\deg a})}{1 - q^{-\sigma}} \right) \\ & \left. - \frac{q+1}{2(q-1)} C_1 h_L \left(\sum_{a|\lambda} q^{\deg a} (\deg \lambda - 2 \deg a) \right) + \left(\sum_{a|\lambda} q^{\deg a} \right) C_2 \right\} \end{aligned}$$

with

$$C_1 := \frac{2(q-1)^2}{[GL_2(\mathbb{F}_q[T]) : \Gamma_0(N)]}$$

and

$$C_2 := -\frac{2(q^2-1)}{[GL_2(\mathbb{F}_q[T]) : \Gamma_0(N)]} h_L \left(\deg N - \sum_{\substack{(P)|(N) \\ (P) \text{ prime}}} \frac{\deg P}{q^{\deg P} + 1} - \frac{\deg D}{2} - \frac{2}{q-1} - \frac{1}{\ln q} \frac{L'_D(1)}{L_D(1)} \right).$$

Combining this with the results for the finite primes finally gives:

THEOREM 3.6.4 *Let deg D be odd and let g_A be the Drinfeld automorphic cusp form of Proposition 3.1.1. Then g_A has the Fourier coefficients for all λ ∈ F_q[T]*

with $\gcd(\lambda, N) = 1$:

$$\begin{aligned}
 & g_{\mathcal{A}}^*(\pi_{\infty}^{\deg \lambda + 2}, \lambda) = \frac{\ln q}{q-1} q^{-\deg \lambda} \\
 & \cdot \left\{ (q-1) r_{\mathcal{A}}((\lambda)) h_L \left(\deg N - \deg(\lambda D) - \frac{q+1}{2(q-1)} - \frac{2}{\ln q} \frac{L'_D(0)}{L_D(0)} \right) \right. \\
 + & \sum_{\substack{\mu \neq 0 \\ \deg(\mu N) \leq \deg(\lambda D)}} r_{\mathcal{A}}((\mu N - \lambda D)) \left(\sum_{c|\mu} \left[\frac{D}{c} \right] \right) (t(\mu, D) + 1) \frac{1 + \delta_{(\mu N - \lambda D)\mu N}}{2} \\
 & \cdot \left(\deg\left(\frac{\mu N}{\lambda D}\right) - \frac{q+1}{2(q-1)} \right) - (1 - \delta_{(\mu N - \lambda D)\mu N}) \left(\sum_{c|\mu} \left[\frac{D}{c} \right] \right) \deg \mu \\
 & \quad + (1 - \delta_{(\mu N - \lambda D)\mu N}) (t(\mu, D) + 1) \left(\sum_{c|\mu} \left[\frac{D}{c} \right] \deg c \right) \\
 - & \frac{q+1}{2(q-1)} \lim_{\sigma \rightarrow 0} \left(\sum_{\deg(\mu N) > \deg(\lambda D)} r_{\mathcal{A}}((\mu N - \lambda D)) \left(\sum_{c|\mu} \left[\frac{D}{c} \right] \right) (t(\mu, D) + 1) \right. \\
 & \quad \cdot q^{(-\sigma-1) \deg(\frac{\mu N}{\lambda D})} - \frac{C_1 h_L(\sum_{a|\lambda} q^{\deg a})}{1 - q^{-\sigma}} \\
 & \quad \left. - \frac{q+1}{2(q-1)} C_1 h_L(\sum_{a|\lambda} q^{\deg a} (\deg \lambda - 2 \deg a)) + (\sum_{a|\lambda} q^{\deg a}) C_2 \right\}
 \end{aligned}$$

with

$$C_1 := \frac{2(q-1)^2}{[GL_2(\mathbb{F}_q[T]) : \Gamma_0(N)]}$$

and

$$\begin{aligned}
 C_2 := & -\frac{2(q^2-1)}{[GL_2(\mathbb{F}_q[T]) : \Gamma_0(N)]} h_L \left(\deg N - \sum_{\substack{(P)|(N) \\ (P) \text{ prime}}} \frac{\deg P}{q^{\deg P} + 1} - \frac{\deg D}{2} \right. \\
 & \left. - \frac{2}{q-1} - \frac{1}{\ln q} \frac{L'_D(1)}{L_D(1)} \right).
 \end{aligned}$$

If $\deg D$ is even, the calculations are the same. We will present only the differences in the formulas to the first case. The calculations with the corresponding Green's function (cf. (3.6.9)) give

$$S = -2 \ln q r_{\mathcal{A}}((\lambda)) \sum_{\tau} \left(\log_q(|\tau|_i | \frac{\partial u}{\partial \tau} |) + \frac{q}{q^2-1} \right).$$

Equation (3.6.12) has to be replaced by

$$\log_q |\Delta(\tau)| = q(q+1) - q |\tau|_i.$$

Hence (3.6.14) has the form

$$S = -2 \ln q r_{\mathcal{A}}((\lambda)) \left(\frac{q^2 + 2q}{q^2 - 1} h_L + \sum_{\tau} \left(-\frac{2q|\tau|_i}{q^2 - 1} + \log_q |\tau|_i \right) \right).$$

The definition (3.6.15) and the relation (3.6.16) remain unchanged, but the rational expression (3.6.17) becomes

$$Ei_s(\tau) = (q - 1) \frac{|\tau|_i^s}{1 - q^{1-2s}} + \frac{q|\tau|_i^{1-s}}{1 - q^{2-2s}} \left((q - 1)^2 \frac{q^{-2s}}{1 - q^{1-2s}} + q - 1 \right).$$

Equation (3.6.18) has to be replaced by

$$\frac{2}{\ln q} \frac{L'_D(0)}{L_D(0)} = -\deg D + \frac{2q^2 + 2q}{q^2 - 1} - \frac{2}{h_L} \sum_{\tau} \left(\frac{2q|\tau|_i}{q^2 - 1} - \log_q |\tau|_i \right).$$

And finally we get:

PROPOSITION 3.6.5 *Let deg D be even, then*

$$\begin{aligned} & \langle (x) - (\infty), T_{\lambda}((x)^{\sigma_A} - (0)) \rangle_{\infty} = \frac{\ln q}{q - 1} \\ & \cdot \left\{ (q - 1) r_{\mathcal{A}}((\lambda)) h_L \left(-\deg D - \frac{2q}{q^2 - 1} - \frac{2}{\ln q} \frac{L'_D(0)}{L_D(0)} \right) \right. \\ & + \sum_{\substack{\mu \neq 0 \\ \deg(\mu N) \leq \deg(\lambda D)}} r_{\mathcal{A}}((\mu N - \lambda D)) \left(\sum_{c|\mu} \left[\frac{D}{c} \right] \right) (t(\mu, D) + 1) \frac{1 + \delta_{(\mu N - \lambda D)\mu N}}{2} \\ & \qquad \qquad \qquad \cdot \left(\deg \left(\frac{\mu N}{\lambda D} \right) - \frac{2q}{q^2 - 1} \right) \\ & - \frac{2q}{q^2 - 1} \lim_{\sigma \rightarrow 0} \left(\sum_{\deg(\mu N) > \deg(\lambda D)} r_{\mathcal{A}}((\mu N - \lambda D)) \left(\sum_{c|\mu} \left[\frac{D}{c} \right] \right) (t(\mu, D) + 1) \right. \\ & \qquad \qquad \qquad \cdot \left. q^{(-\sigma - 1) \deg \left(\frac{\mu N}{\lambda D} \right)} - \frac{C_1 h_L (\sum_{a|\lambda} q^{\deg a})}{1 - q^{-\sigma}} \right) \\ & \left. - \frac{2q}{q^2 - 1} C_1 h_L \left(\sum_{a|\lambda} q^{\deg a} (\deg \lambda - 2 \deg a) \right) + \left(\sum_{a|\lambda} q^{\deg a} \right) C_2 \right\} \end{aligned}$$

with

$$C_1 := \frac{(q^2 - 1)^2}{2q [GL_2(\mathbb{F}_q[T]) : \Gamma_0(N)]}$$

and

$$C_2 := -\frac{2(q^2 - 1)}{[GL_2(\mathbb{F}_q[T]) : \Gamma_0(N)]} h_L \left(\deg N - \sum_{\substack{(P)|(N) \\ (P) \text{ prime}}} \frac{\deg P}{q^{\deg P} + 1} - \frac{\deg D}{2} \right. \\ \left. - \frac{q + 3}{q^2 - 1} - \frac{1}{\ln q} \frac{L'_D(1)}{L_D(1)} \right).$$

Combining this with the results for the finite places yields:

THEOREM 3.6.6 *Let $\deg D$ be even and let $g_{\mathcal{A}}$ be the Drinfeld automorphic cusp form of Proposition 3.1.1. Then $g_{\mathcal{A}}$ has the Fourier coefficients for all $\lambda \in \mathbb{F}_q[T]$ with $\gcd(\lambda, N) = 1$:*

$$g_{\mathcal{A}}^*(\pi_{\infty}^{\deg \lambda + 2}, \lambda) = \frac{\ln q}{q - 1} q^{-\deg \lambda} \\ \cdot \left\{ r_{\mathcal{A}}((\lambda)) h_L(q - 1) \left(\deg N - \deg(\lambda D) - \frac{2q}{q^2 - 1} - \frac{2}{\ln q} \frac{L'_D(0)}{L_D(0)} \right) \right. \\ + \sum_{\substack{\mu \neq 0 \\ \deg(\mu N) \leq \deg(\lambda D)}} r_{\mathcal{A}}((\mu N - \lambda D)) \left(\sum_{c|\mu} \left[\frac{D}{c} \right] \right) (t(\mu, D) + 1) \frac{1 + \delta_{(\mu N - \lambda D)\mu N}}{2} \\ \cdot \left(\deg\left(\frac{\mu N}{\lambda D}\right) - \frac{2q}{q^2 - 1} \right) - (1 - \delta_{(\mu N - \lambda D)\mu N}) \left(\sum_{c|\mu} \left[\frac{D}{c} \right] \right) \deg \mu \\ + (1 - \delta_{(\mu N - \lambda D)\mu N}) (t(\mu, D) + 1) \left(\sum_{c|\mu} \left[\frac{D}{c} \right] \deg c \right) \\ - \frac{2q}{q^2 - 1} \lim_{\sigma \rightarrow 0} \left(\sum_{\deg(\mu N) > \deg(\lambda D)} r_{\mathcal{A}}((\mu N - \lambda D)) \left(\sum_{c|\mu} \left[\frac{D}{c} \right] \right) (t(\mu, D) + 1) \right. \\ \left. \cdot q^{(-\sigma - 1) \deg(\frac{\mu N}{\lambda D})} - C_1 h_L \left(\sum_{a|\lambda} q^{\deg a} \right) \frac{1}{1 - q^{-\sigma}} \right) \\ \left. - \frac{2q}{q^2 - 1} C_1 h_L \left(\sum_{a|\lambda} q^{\deg a} (\deg \lambda - 2 \deg a) \right) + \left(\sum_{a|\lambda} q^{\deg a} \right) C_2 \right\}$$

with

$$C_1 := \frac{(q^2 - 1)^2}{2q[GL_2(\mathbb{F}_q[T]) : \Gamma_0(N)]}$$

and

$$C_2 := -\frac{2(q^2 - 1)}{[GL_2(\mathbb{F}_q[T]) : \Gamma_0(N)]} h_L \left(\deg N - \sum_{\substack{(P)|(N) \\ (P) \text{ prime}}} \frac{\deg P}{q^{\deg P} + 1} - \frac{\deg D}{2} - \frac{q + 3}{q^2 - 1} - \frac{1}{\ln q} \frac{L'_D(1)}{L_D(1)} \right).$$

4 CONCLUSION

4.1 MAIN RESULTS

Now we combine the previous chapters on L -series (chapter 2) and on Heegner points (chapter 3). We recall the assumptions: $D \in \mathbb{F}_q[T]$ is an irreducible polynomial and $N \in \mathbb{F}_q[T]$ is a square free polynomial, whose prime divisors are split in the imaginary quadratic extension $K(\sqrt{D})/K$.

If $\deg D$ is odd, we evaluated in Theorem 2.8.2 the Fourier coefficients $\Psi_{\mathcal{A}}^*(\pi_{\infty}^{\deg \lambda + 2}, \lambda)$ of an automorphic cusp form $\Psi_{\mathcal{A}}$ of Drinfeld type with

$$\frac{\partial}{\partial s} (L^{(N,D)}(2s + 1)L(f, \mathcal{A}, s)) \Big|_{s=0} = \int_{\Gamma_0(N) \backslash GL_2(K_{\infty}) / \Gamma_{\infty} K_{\infty}^*} f \cdot \overline{\Psi_{\mathcal{A}}}.$$

On the other hand, in Theorem 3.6.4 we obtained the Fourier coefficients of $g_{\mathcal{A}}$, which are defined as

$$g_{\mathcal{A}}^*(\pi_{\infty}^{\deg \lambda + 2}, \lambda) = q^{-\deg \lambda} \langle (x) - (\infty), T_{\lambda}((x)^{\sigma_{\mathcal{A}}} - (0)) \rangle.$$

If we compare the two formulas, we see that

$$\Psi_{\mathcal{A}}^*(\pi_{\infty}^{\deg \lambda + 2}, \lambda) = \frac{q - 1}{2} q^{-(\deg D + 1)/2} g_{\mathcal{A}}^*(\pi_{\infty}^{\deg \lambda + 2}, \lambda)$$

for all $\lambda \in \mathbb{F}_q[T]$ with $\gcd(\lambda, N) = 1$. Hence the two automorphic cusp forms $\Psi_{\mathcal{A}}$ and $(q - 1)/2 \cdot q^{-(\deg D + 1)/2} g_{\mathcal{A}}$ differ only by an old form. Since f is a newform, the occurring old form does not affect the integral. And this can be summarized by the following main result:

THEOREM 4.1.1 *Let $\deg D$ be odd. Let x be a Heegner point on $X_0(N)$ with complex multiplication by $O_L = \mathbb{F}_q[T][\sqrt{D}]$, let $\mathcal{A} \in Cl(O_L)$, and let $g_{\mathcal{A}}$ be the automorphic cusp form of Drinfeld type of level N , which is given by*

$$(T_{\lambda} g_{\mathcal{A}})^*(\pi_{\infty}^2, 1) = \langle (x) - (\infty), T_{\lambda}((x)^{\sigma_{\mathcal{A}}} - (0)) \rangle$$

for all $\lambda \in \mathbb{F}_q[T]$. Let f be a newform of level N , then

$$\frac{\partial}{\partial s} (L^{(N,D)}(2s + 1)L(f, \mathcal{A}, s)) \Big|_{s=0} = \frac{q - 1}{2} q^{-(\deg D + 1)/2} \int_{\Gamma_0(N) \backslash GL_2(K_{\infty}) / \Gamma_{\infty} K_{\infty}^*} f \cdot \overline{g_{\mathcal{A}}}.$$

If $\deg D$ is even, we have to compare Theorem 2.8.3 and Theorem 3.6.6. Let $\Psi_{\mathcal{A}}$ be defined by

$$\frac{\partial}{\partial s} \left(\frac{1}{1+q^{-s-1}} L^{(N,D)}(2s+1)L(f, \mathcal{A}, s) \right) |_{s=0} = \int_{\Gamma_0(N) \backslash GL_2(K_\infty) / \Gamma_\infty K_\infty^*} f \cdot \overline{\Psi_{\mathcal{A}}}.$$

The Fourier coefficients of $\Psi_{\mathcal{A}}$ and $g_{\mathcal{A}}$ satisfy

$$\Psi_{\mathcal{A}}^*(\pi_\infty^{\deg \lambda + 2}, \lambda) = \frac{q-1}{4} q^{-\deg D/2} g_{\mathcal{A}}^*(\pi_\infty^{\deg \lambda + 2}, \lambda)$$

for all $\lambda \in \mathbb{F}_q[T]$ with $\gcd(\lambda, N) = 1$. Hence we have

THEOREM 4.1.2 *Let $\deg D$ be even. Let x be a Heegner point on $X_0(N)$ with complex multiplication by $O_L = \mathbb{F}_q[T][\sqrt{D}]$, let $\mathcal{A} \in Cl(O_L)$, and let $g_{\mathcal{A}}$ be the automorphic cusp form of Drinfeld type of level N , which is given by*

$$(T_\lambda g_{\mathcal{A}})^*(\pi_\infty^2, 1) = \langle (x) - (\infty), T_\lambda((x)^{\sigma_{\mathcal{A}}} - (0)) \rangle$$

for all $\lambda \in \mathbb{F}_q[T]$. Let f be a newform of level N , then

$$\frac{\partial}{\partial s} \left(\frac{1}{1+q^{-s-1}} L^{(N,D)}(2s+1)L(f, \mathcal{A}, s) \right) |_{s=0} = \frac{q-1}{4} q^{-\deg D/2} \int_{\Gamma_0(N) \backslash GL_2(K_\infty) / \Gamma_\infty K_\infty^*} f \cdot \overline{g_{\mathcal{A}}}.$$

4.2 APPLICATION TO ELLIPTIC CURVES

We want to apply our main results to elliptic curves. Therefore we assume in addition that the newform f is an eigenform for all Hecke operators. So far we haven't required this condition in our calculations.

Let χ be a character of the class group $Cl(O_L)$. If $\deg D$ is odd, we define

$$L(f, \chi, s) := \sum_{\mathcal{A} \in Cl(O_L)} \chi(\mathcal{A}) L^{(N,D)}(2s+1)L(f, \mathcal{A}, s).$$

Then Theorem 4.1.1 yields immediately

$$\frac{\partial}{\partial s} L(f, \chi, s) |_{s=0} = \frac{q-1}{2} q^{-(\deg D+1)/2} \int_{\Gamma_0(N) \backslash GL_2(K_\infty) / \Gamma_\infty K_\infty^*} f \cdot \overline{\sum_{\mathcal{A}} \chi(\mathcal{A}) g_{\mathcal{A}}}. \tag{4.2.1}$$

Note that $\sum_{\mathcal{A}} \chi(\mathcal{A}) g_{\mathcal{A}}$ is an automorphic cusp form which satisfies (cf. the definition of $g_{\mathcal{A}}$ in Proposition 3.1.1)

$$(T \sum_{\mathcal{A}} \chi(\mathcal{A}) g_{\mathcal{A}})^*(\pi_\infty^2, 1) = \sum_{\mathcal{A}} \chi(\mathcal{A}) \langle (x) - (\infty), T((x)^{\sigma_{\mathcal{A}}} - (0)) \rangle \tag{4.2.2}$$

for each Hecke operator T . Exactly the same calculations as in [Gr-Za], p. 308 show that (4.2.2) can be computed as

$$(T \sum_{\mathcal{A}} \chi(\mathcal{A}) g_{\mathcal{A}})^*(\pi_{\infty}^2, 1) = h_L^{-1} \langle c_{\chi}, T c_{\chi} \rangle,$$

where $c_{\chi} = \sum_{\mathcal{A}} \chi^{-1}(\mathcal{A})((x) - (\infty))^{\sigma_{\mathcal{A}}}$ is an element in the Jacobian $J_0(N)(H) \otimes \mathbb{C}$. Here we used the fact that $(0) - (\infty)$ is an element of finite order in $J_0(N)$ (cf. [Ge2, Satz 4.1]).

Let $\{f_i\}$ be a basis of the space of automorphic cusp forms of Drinfeld type of level N which consists of normalized newforms together with a basis of the space of oldforms. We assume that $f_1 = f$. And let $c_{\chi} = \sum_i c_{\chi}^{(i)}$ be the decomposition of c_{χ} in f_i -isotypical components (i.e. components, where the Hecke operators act by multiplication of the corresponding Hecke eigenvalues). Then again as in [Gr-Za], p. 308 we get

$$\sum_{\mathcal{A}} \chi(\mathcal{A}) g_{\mathcal{A}} = h_L^{-1} \sum_{i,j} \langle c_{\chi}^{(i)}, c_{\chi}^{(j)} \rangle f_j. \quad (4.2.3)$$

Since f is a newform, we have $\langle c_{\chi}^{(i)}, c_{\chi}^{(1)} \rangle = 0$ for $i \neq 1$. Then equations (4.2.1) and (4.2.3) yield:

COROLLARY OF THEOREM 4.1.1 *If deg D is odd, then*

$$\begin{aligned} \frac{\partial}{\partial s} L(f, \chi, s) |_{s=0} &= \frac{q-1}{2} q^{-(\deg D+1)/2} \cdot \\ &\cdot h_L^{-1} \langle c_{\chi}^{(1)}, c_{\chi}^{(1)} \rangle \int_{\Gamma_0(N) \backslash GL_2(K_{\infty}) / \Gamma_{\infty} K_{\infty}^*} f \cdot \bar{f}. \end{aligned}$$

If deg D is even we define

$$L(f, \chi, s) := \sum_{\mathcal{A} \in Cl(O_L)} \chi(\mathcal{A}) \frac{1}{1+q^{-s-1}} L^{(N,D)}(2s+1) L(f, \mathcal{A}, s),$$

and we get analogously:

COROLLARY OF THEOREM 4.1.2 *If deg D is even, then*

$$\begin{aligned} \frac{\partial}{\partial s} L(f, \chi, s) |_{s=0} &= \frac{q-1}{4} q^{-\deg D/2} \cdot \\ &\cdot h_L^{-1} \langle c_{\chi}^{(1)}, c_{\chi}^{(1)} \rangle \int_{\Gamma_0(N) \backslash GL_2(K_{\infty}) / \Gamma_{\infty} K_{\infty}^*} f \cdot \bar{f}. \end{aligned}$$

Now let E be an elliptic curve with conductor $N \cdot \infty$, which has split multiplicative reduction at ∞ , and let f be the corresponding newform as in section 2.1. We have already seen that the L -series of E over the imaginary quadratic field L

satisfies (with the notations of this section) $L(E, s+1)L(E_D, s+1) = L(f, \chi_0, s)$, where χ_0 is the trivial character of $Cl(O_L)$.

Let $\pi : X_0(N) \rightarrow E$ be a uniformization (cf. [Ge-Re], (8)) which maps the point ∞ on $X_0(N)$ to the zero on E . The two homomorphisms $\pi_* : J_0(N) \rightarrow E$ and $\pi^* : E \rightarrow J_0(N)$ are related by the formula $\pi_* \circ \pi^* = \text{deg } \pi$. On $J_0(N)$ we consider the elliptic curve $E' = \pi^*(E)$. Then $\pi_{*|E'}$ and π^* are dual isogenies of E and E' , in particular we get

$$\pi^* \circ \pi_{*|E'} = \text{deg } \pi. \tag{4.2.4}$$

For a Heegner point x on $X_0(N)$ let $P_L := \sum_{\mathcal{A} \in Cl(O_L)} \pi(x^{\sigma_{\mathcal{A}}})$ be the corresponding Heegner point on E . The component $c_{\chi_0}^{(1)}$ lies on E' and we have

$$\pi_{*|E'}(c_{\chi_0}^{(1)}) = P_L. \tag{4.2.5}$$

The points P_L on E and $c_{\chi_0}^{(1)}$ on $J_0(N)$ are both defined over the field L . Let $\hat{h}_{E,L}$ be the canonical Néron-Tate height of E over L , analogously we consider $\hat{h}_{J_0(N),L}$. If we apply the projection formula and equations (4.2.4) and (4.2.5) we get

$$\begin{aligned} \text{deg } \pi \cdot \hat{h}_{J_0(N),L}(c_{\chi_0}^{(1)}) &= \langle \text{deg } \pi \cdot c_{\chi_0}^{(1)}, c_{\chi_0}^{(1)} \rangle_{J_0(N),L} \\ &= \langle \pi^* \circ \pi_{*|E'}(c_{\chi_0}^{(1)}), c_{\chi_0}^{(1)} \rangle_{J_0(N),L} \\ &= \langle \pi_{*|E'}(c_{\chi_0}^{(1)}), \pi_{*|E'}(c_{\chi_0}^{(1)}) \rangle_{E,L} \\ &= \hat{h}_{E,L}(P_L). \end{aligned} \tag{4.2.6}$$

Since the height pairing $\langle \cdot, \cdot \rangle$ is normalized for the Hilbert class field H (cf. section 3.1), we have

$$\langle c_{\chi_0}^{(1)}, c_{\chi_0}^{(1)} \rangle = h_L \cdot \hat{h}_{J_0(N),L}(c_{\chi_0}^{(1)}). \tag{4.2.7}$$

Now (4.2.6), (4.2.7) and the two corollaries yield in the case of elliptic curves:

THEOREM 4.2.1 *Let E be an elliptic curve with conductor $N \cdot \infty$, which has split multiplicative reduction at ∞ , with corresponding newform f as above, let $P_L \in E(L)$ be the Heegner point given by the parametrization $\pi : X_0(N) \rightarrow E$. Then the derivative of the L-series of E over L and the canonical height $\hat{h}_{E,L}(P_L)$ are related by the formula*

$$\frac{\partial}{\partial s}(L(E, s)L(E_D, s)) \Big|_{s=1} = \hat{h}_{E,L}(P_L) c(D) (\text{deg } \pi)^{-1} \int_{\Gamma_0(N) \backslash GL_2(K_\infty) / \Gamma_\infty K_\infty^*} f \cdot \bar{f},$$

where the constant

$$c(D) := \begin{cases} \frac{q-1}{2} q^{-(\text{deg } D+1)/2} & \text{if } \text{deg } D \text{ is odd,} \\ \frac{q-1}{4} q^{-\text{deg } D/2} & \text{if } \text{deg } D \text{ is even.} \end{cases}$$

Finally we mention just one consequence of Theorem 4.2.1. The L -series $L(E, s) \cdot L(E_D, s)$ of E over the field L has a zero at $s = 1$ according to the functional equations of section 2.7. In the function field case it is known ([Ta], [Sh]) that the analytic rank of E/L is not smaller than the Mordell-Weil rank of $E(L)$. Therefore Theorem 4.2.1 implies

COROLLARY 4.2.2 *If*

$$\frac{\partial}{\partial s}(L(E, s)L(E_D, s))|_{s=1} \neq 0,$$

then the Birch and Swinnerton-Dyer conjecture is true for E , i.e. the analytic rank and the Mordell-Weil rank of E/L are both equal to 1.

REMARKS.

- 1) In [Br] Brown proved the Birch and Swinnerton-Dyer conjecture in the case that the Heegner point has infinite order. And he conjectured that this assumption is true if and only if the first derivative of the L -series does not vanish at the point 1. Theorem 4.2.1 proves his conjecture.
- 2) Milne ([Mi]) showed that the equality of the analytic rank and the Mordell-Weil rank implies even the strong Birch and Swinnerton-Dyer conjecture. Therefore in our case the assumption of Corollary 4.2.2 implies

$$\frac{\partial}{\partial s}L^*(E/L, s)|_{s=1} = \frac{\#III \cdot \hat{h}_{E,L}(P_0)}{(\#E(L)_{\text{tors}})^2},$$

where $L^*(E/L, s)$ is the modified L -series of the elliptic curve E over the field L (cf. [Ta], [Mi]), P_0 is a generator of the free part of the Mordell-Weil group $E(L)$ and III is the Tate-Shafarevich group of E/L .

REFERENCES

- [AB] *Proceedings of the Workshop on Drinfeld Modules, Modular Schemes and Applications in Alden-Biesen*, Gekeler et al. (Eds.), World Scientific, 1996.
- [Ar] E. Artin, *Quadratische Körper im Gebiete der höheren Kongruenzen II.*, Math. Zeitschrift 19 (1924), 207-246.
- [Br] M. L. Brown, *On a conjecture of Tate for elliptic surfaces over finite fields*, Proc. London Math. Soc.(3), 69 (1994), no.3, 489-514
- [De] P. Deligne, *Les constantes des équations fonctionnelles des fonctions L* , in: Modular functions of one variable II, LNM 349, Springer (1973), 501-597.
- [Deu] M. Deuring, *Die Klassenkörper der komplexen Multiplikation*, Enzyklopädie der Math. Wiss. Band I, 2. Teil, Heft 10, Teil II.
- [Dr] V. G. Drinfeld, *Coverings of p -adic symmetric regions*, Funct. Anal. Appl. 10 (1976), 29-40.

- [De-Hu] P. Deligne, D. Husemöller, *Survey of Drinfeld modules*, Contemp. Math. 67 (1987), 25-91.
- [Ei] M. Eichler, *Zur Zahlentheorie der Quaternionen-Algebren*, Journal reine angew. Math. 195 (1956), 127-151.
- [Ge1] E.-U. Gekeler, *Drinfeld modular curves*, LNM 1231, Springer, 1986.
- [Ge2] E.- U. Gekeler, *Über Drinfeldsche Modulkurven vom Hecke-Typ*, Compositio Mathematica 57 (1986), 219-236.
- [Ge3] E.- U. Gekeler, *Analytic Construction of Weil Curves over Function Fields*, J. Th. Nomb. Bordeaux 7 (1995), 27-49.
- [Ge4] E.- U. Gekeler, *On Finite Drinfeld Modules*, J. of Algebra 141 (1991), 187-203.
- [Ge-Re] E.-U. Gekeler, M. Reversat, *Jacobians of Drinfeld modular curves*, Journal reine angew. Math. 476 (1996), 27-93.
- [Ger-vdP] L. Gerritzen, M. van der Put, *Schottky groups and Mumford curves*, LNM 817, Springer.
- [Go] D. Goss, *Modular Forms for $\mathbb{F}_r[T]$* , Journal reine angew. Math. 317 (1980), 16-39.
- [Gr1] B. Gross, *Local heights on curves in "Arithmetic geometry"*, (ed. Cornell/Silverman) Springer 1986.
- [Gr2] B. Gross, *On canonical and quasi-canonical liftings*, Invent Math. 84 (1986), 321-326.
- [Gr-Za] B. Gross, D. Zagier, *Heegner points and derivatives of L -series*, Invent. Math. 84 (1986), 225-320.
- [Ha] D. R. Hayes, *Explicit class field theory in global function fields*, Studies in Algebra and Number Theory, Advances in Mathematics supplementary studies vol.6, Academic Press (1979), 173-217.
- [Ka-Ma] N. Katz, B. Mazur, *Arithmetic moduli of elliptic curves*, Princeton, Princeton University Press, 1985.
- [Mi] J. S. Milne, *On a conjecture of Artin-Tate*, Ann. of Math. 102 (1975), 517-533
- [Rü1] H.-G. Rück, *Theta Series of Imaginary Quadratic Function Fields*, manuscripta math. 88 (1995), 387-407.
- [Rü2] H.-G. Rück, *Poincaré Series of Drinfeld Type*, Arch. Math. 68 (1997), 190-201.
- [Rü3] H.-G. Rück, *L -series of automorphic cusp forms of Drinfeld type*, Proceedings of the Workshop on Drinfeld modules, modular schemes and applications, Alden-Biesen, World Scientific, 1996, 311-329.
- [Rü-Ti] H.-G. Rück, U. Tipp, *A Gross-Zagier formula for function fields*, in "Algorithmic Algebra and Number Theory" (ed. Matzat et al.), Lectures given at a DFG-Conference at Heidelberg University in October 1997, Springer.

- [Sha] I. R. Shafarevich, *Lectures on minimal models and birational transformations of two dimensional schemes*, Tata Institute, Bombay (1966).
- [Sh] T. Shioda, *Some remarks on elliptic curves over function fields*, Astérisque 209 (1992), 99-114.
- [Ta] J. Tate, *On the conjectures of Birch and Swinnerton-Dyer and a geometric analog*, Sémin. Bourbaki 1965/66 in: Dix Exposés sur la Cohomologie des Schemas, Amsterdam, North Holland, 1968.
- [Ti1] U. Tipp, *Höhenberechnungen von Heegnerpunkten auf Drinfeldschen Modulcurven*, Dissertation, Preprint No.10, IEM Essen, 1996.
- [Ti2] U. Tipp, *Local height pairings of Heegner points on Drinfeld modular curves*, Proceedings of the Workshop on Drinfeld modules, modular schemes and applications, Alden-Biesen, World Scientific, 1996, 344-356.
- [Ti3] U. Tipp, *Green's functions for Drinfeld modular curves*, J. of Number Theory 77 (1999), 171-199.
- [We1] A. Weil, *Dirichlet Series and Automorphic Forms*, LNM 189, Springer 1971.
- [We2] A. Weil, *On the Analogue of the Modular group in Characteristic p* , in "Functional Analysis, etc", Proc. Conf. in honor of M. Stone, Springer 1970, 211-223.

Hans-Georg Rück
Fachbereich 17
D-34109 Kassel, Germany
rueck@mathematik.uni-kassel.de

Ulrich Tipp
secunet AG
Im Teelbruch 116
D-45219 Essen
tipp@secunet.de

MOTIVIC SYMMETRIC SPECTRA

J. F. JARDINE

Received: September 10, 1999

Revised: May 1, 2000

Communicated by Peter Schneider

ABSTRACT. This paper demonstrates the existence of a theory of symmetric spectra for the motivic stable category. The main results together provide a categorical model for the motivic stable category which has an internal symmetric monoidal smash product. The details of the basic construction of the Morel-Voevodsky proper closed simplicial model structure underlying the motivic stable category are required to handle the symmetric case, and are displayed in the first three sections of this paper.

1991 Mathematics Subject Classification: 55P42, 14F42, 55U35

Keywords and Phrases: motivic stable category, symmetric spectra

INTRODUCTION

This paper gives a method for importing the stable homotopy theory of symmetric spectra [7] into the motivic stable category of Morel and Voevodsky [14], [16], [17]. This category arises from a closed model structure on a suitably defined category of spectra on a smooth Nisnevich site, and it is fundamental for Voevodsky's proof of the Milnor Conjecture [16]. The motivic stable category acquires an effective theory of smash, or non-abelian tensor products with the results presented here.

Loosely speaking, the motivic stable category is the result of formally inverting the functor $X \mapsto T \wedge X$ within motivic homotopy theory, where T is the quotient of sheaves $\mathbb{A}^1/(\mathbb{A}^1 - 0)$. In this context, a spectrum X , or T -spectrum, consists of pointed simplicial presheaves X^n , $n \geq 0$, together with bonding maps $T \wedge X^n \rightarrow X^{n+1}$. The theory is exotic in at least two ways: it lives within the motivic model category, which is a localized theory of simplicial presheaves, and the object T is not a circle in any sense, but is rather motivic equivalent to an honest suspension $S^1 \wedge \mathbb{G}_m$ of the scheme underlying the multiplicative group. Smashing with T is thus a combination of topological and geometric suspensions.

A symmetric spectrum in this category is a T -spectrum Y which is equipped with symmetric group actions $\Sigma_n \times Y^n \rightarrow Y^n$ in all levels such that all composite bonding maps $T^{\wedge p} \wedge X^n \rightarrow X^{p+n}$ are $(\Sigma_p \times \Sigma_n)$ -equivariant. The main theorems of this paper assert that this category of symmetric spectra carries a notion of stable equivalence within the motivic model category which is part of a proper closed simplicial model structure (Theorem 4.15), and such that the forgetful functor to T -spectra induces an equivalence of the stable homotopy category for symmetric spectra with the motivic stable category (Theorem 4.31). This collection of results gives a category which models the motivic stable category, and also has a symmetric monoidal smash product.

The relation between spectra and symmetric spectra in motivic homotopy theory is an exact analogue of that found in ordinary homotopy theory. In this way, every T -spectrum is representable by a symmetric object, but some outstanding examples of T -spectra are intrinsically symmetric. These include the T -spectrum $\mathbf{H}_{\mathbb{Z}}$ which represents motivic cohomology [18].

The principal results of this paper are simple enough to state, but a bit complicated to demonstrate in that their proofs involve some fine detail from the construction of the motivic stable category. It was initially expected, given the experience of [13], that the passage from spectra to symmetric spectra would be essentially axiomatic, along the lines of the original proof of [7]. This remains true in a gross sense, but many of the steps in the proofs of [7] and [13] involve standard results from stable homotopy theory which cannot be taken for granted in the motivic context. In particular, the construction of the motivic stable category is quite special: one proves it by verifying the Bousfield-Friedlander axioms A4 – A6 [2], but the proofs of these axioms involve Nisnevich descent in a non-trivial way, and essentially force the introduction of the concept of flasque simplicial presheaf. The class of flasque simplicial presheaves contains all globally fibrant objects, but is also closed under filtered colimit (*unlike* fibrant objects — the assertion to the contrary is a common error) and the “ T -loop” functor. It is a key technical point that these constructions also preserve many pointwise weak equivalences, such as those arising from Nisnevich descent.

We must also use a suitable notion of compact object, so that the corresponding loop functors commute with filtered colimits. The class of compact simplicial presheaves is closed under finite smash product and homotopy cofibre, and includes all finite simplicial sets and smooth schemes over a decent base. As a result, the Morel-Voevodsky object belongs to a broader class of compact objects T for which the corresponding categories of T -spectra on the smooth Nisnevich site have closed model structures associated to an adequate notion of stable equivalence. These ideas are the subject of the first two sections of this paper and culminate in Theorem 2.9, which asserts the existence of the model structure.

Theorem 2.9 is proved without reference to stable homotopy groups. This is achieved in part by using an auxiliary closed model structure for T -spectra, for which the cofibrations (respectively weak equivalences) are maps which

are cofibrations (respectively motivic weak equivalences) in each level. The fibrant objects for the theory are called injective objects, and one can show (Lemma 2.11) that the functor defined by naive homotopy classes of maps taking values in objects W which are both injective and stably fibrant for the theory detects stable equivalences. This idea was lifted from [7], and appears again for symmetric spectra in Section 4.

It is crucial for the development of the stable homotopy theory of symmetric spectra as presented here (eg. Proposition 4.13, proof of Theorem 4.15) to know that fibre sequences and cofibre sequences of ordinary spectra coincide up to motivic stable equivalence — this is the first major result of Section 3 (Lemma 3.9, Corollary 3.10). The method of proof involves long exact sequences in weighted stable homotopy groups. These groups were introduced in [16], but the present construction is predicated on knowing that a spectrum X is a piece of an asymmetric bispectrum object for which one smashes with the simplicial circle S^1 in one direction and with the scheme \mathbb{G}_m in the other.

The section closes with a proof of the assertion (Theorem 3.11, Corollary 3.16) that the functors $X \mapsto X \wedge T$ and $Y \mapsto \Omega_T Y$ are inverse to each other on the motivic stable category. This proof uses Voevodsky's observation that twisting the 3-fold smash product $T^3 = T^{\wedge 3}$ by a cyclic permutation of order 3 is the identity in the motivic homotopy category — this is Lemma 3.13. This result is also required for showing that the stable homotopy category of symmetric spectra is equivalent to the motivic stable category.

Section 4 contains the main results: the model structure for stable equivalences of symmetric spectra is Theorem 4.15, and the equivalence of stable categories is Theorem 4.31. With all of the material in the previous sections in place, and subject to being careful about the technical difficulties underlying the stability functor for the category of spectra, the derivation of the proper closed simplicial model structure for symmetric spectra follows the method developed in [7] and [13]. The demonstration of the equivalence of stable categories is also by analogy with the methods of those papers, but one has to be a bit more careful again, so that it is necessary to discuss T -bispectra in a limited way.

It would appear that the compactness of T and the triviality of the action of the cyclic permutation on T^3 are minimum requirements for setting up the full machinery of spectra and symmetric spectra, along with the equivalence of stable categories within motivic homotopy theory, at least according to the proofs given here (see also [6]). These features are certainly present for the original categories of presheaves of spectra and symmetric spectra in motivic homotopy theory. This is the case $T = S^1$ for the results of Section 2, and the corresponding thread of results (Theorem 2.9, Remark 3.22) for the motivic stable categories of S^1 -spectra and symmetric S^1 -spectra concludes in Section 4.5 with an equivalence of motivic stable homotopy categories statement in Theorem 4.40. There is also a rather generic result about the interaction between cofibrations and the smash product in the category of symmetric spectrum objects which obtains in all of the cases at hand — see Proposition 4.41. The

motivic stable homotopy theory of S^1 -spectra has found recent application in [19].

This paper concludes with two appendices. Appendix A shows that formally inverting a rational point $f : * \rightarrow I$ of a simplicial presheaf I on an arbitrary small Grothendieck site gives a closed model structure which is proper (Theorem A.5). This result specializes to a proof that the motivic closed model structure is proper, but does not depend on the object I being an interval in any sense — compare [14, Theorem 2.3.2].

The purpose of Appendix B is to show that the category of presheaves on the smooth Nisnevich site $(Sm|_S)_{Nis}$ inherits a proper closed simplicial model structure from the corresponding category of simplicial presheaves, such that the presheaf category is a model for motivic homotopy theory. The main result is Theorem B.4. The corresponding sheaf theoretic result appears as Theorem B.6, and this is the foundation of the Morel-Voevodsky category of spaces model for motivic homotopy theory. I have included this on the grounds that it so far appears explicitly nowhere else, though the alert reader can cobble a proof together from the ideas in [14]. The only particular claim to originality of the results presented in Appendix B is the observation that the Morel-Voevodsky techniques also make sense on the presheaf level.

This paper has gone through a rather long debugging phase that began with its appearance under the original title “ \mathbb{A}^1 -local symmetric spectra” on the K -theory preprint server in September, 1998. I would like to thank a group of referees for their remarks and suggestions. One such remark was that the proof of Lemma 3.14 in the original version was incorrect, and should involve Voevodsky’s Lemma 3.13. The corrected form of this result now appears as Theorem 3.11. Another suggestion was to enlarge the class of base schemes from fields to Noetherian schemes S of finite dimension, and this has been done here — the only technical consequence was the necessity to strengthen Lemma 3.13 to a statement that holds over the integers.

There has been a rather substantial shift in language with the present version of the paper. In particular, the use of the term “motivic homotopy theory” has become standard recently, and is incorporated here in place of either the old homotopy theoretic convention “ f -local theory” [4] for the localized theory associated to a rational point $f : * \rightarrow \mathbb{A}^1$, or the “ \mathbb{A}^1 -homotopy theory” of [14]. Motivic homotopy theory is the fundamental object of discussion; at the risk of confusing readers who like to start in the middle, “weak equivalence” means “motivic weak equivalence” and similarly fibrations and cofibrations are in the motivic closed model structure, unless explicit mention is made to the contrary.

This work owes an enormous debt to that of Fabien Morel, Jeff Smith and Vladimir Voevodsky, and to conversations with all three; I would like to take this opportunity to thank them. Several of the main results of the first two sections of this paper were announced in some form in [16], while the unstable Nisnevich descent technique that is so important here was brought to my

attention by Morel, and appears in [14].

The conversations that I refer to took place at a particularly stimulating meeting on the homotopy theory of algebraic varieties at the Mathematical Sciences Research Institute in Berkeley in May, 1998. The idea for this project was essentially conceived there, while Appendix A was mostly written a few weeks prior during a visit to Université Paris VII. I thank both institutions for their hospitality and support.

CONTENTS

1	PRELIMINARIES	450
1.1	Motivic homotopy theory	450
1.2	Controlled fibrant models	453
1.3	Nisnevich descent	456
1.4	Flasque simplicial presheaves	460
2	MOTIVIC STABLE CATEGORIES	463
2.1	The level structures	464
2.2	Compact objects	466
2.3	The stable closed model structure	468
2.4	Change of suspension	476
2.5	Bounded cofibrations	479
3	FIBRE AND COFIBRE SEQUENCES	482
3.1	Exact sequences for S^1 -spectra	482
3.2	Weighted stable homotopy groups	486
3.3	Fibre and cofibre sequences	490
3.4	T -suspensions and T -loops	493
4	MOTIVIC SYMMETRIC SPECTRA	504
4.1	The level structure	505
4.2	The stable structure	508
4.3	The smash product	517
4.4	Equivalence of stable categories	523
4.5	Symmetric S^1 -spectra	532
A	PROPERNESS	536
B	MOTIVIC HOMOTOPY THEORY OF PRESHEAVES	541
C	INDEX	551

1 PRELIMINARIES

1.1 MOTIVIC HOMOTOPY THEORY

One starts with a rational point $f : * \rightarrow \mathbb{A}^1$ of the affine line \mathbb{A}^1 in the category of smooth schemes $(Sm|_S)_{Nis}$ of finite type over a scheme S of finite dimension, equipped with the Nisnevich topology. The empty scheme \emptyset is a member of this category.

The localization theory arising from “formally inverting” the map f in the standard, or local homotopy theory of simplicial presheaves on $(Sm|_S)_{Nis}$ is the motivic homotopy theory for the scheme S — it has been formerly called both the f -local theory [4] and the \mathbb{A}^1 -homotopy theory [14].

The standard homotopy theory of simplicial presheaves arises from a proper closed model structure that exists quite generally [9], [12] for simplicial presheaves on arbitrary small Grothendieck sites. In cases, like the Nisnevich site, where stalks are available, a *local weak equivalence* (or *stalkwise weak equivalence*) is a map of simplicial presheaves which induces a weak equivalence of simplicial sets in all stalks. A *cofibration* is a monomorphism of simplicial presheaves, and a *global fibration* is a map which has the right lifting property with respect to all maps which are cofibrations and local weak equivalences. A proper closed simplicial model structure for simplicial sheaves on an arbitrary Grothendieck site arises from similar definitions (cofibrations are monomorphisms, local weak equivalences are defined stalkwise, and global fibrations are defined by a lifting property), and the resulting homotopy category for simplicial sheaves is equivalent to the homotopy category associated to the closed model structure on simplicial presheaves. In particular, the associated sheaf map $\eta : X \rightarrow \tilde{X}$ from a simplicial presheaf to its associated simplicial sheaf is a local weak equivalence, since it induces an isomorphism on stalks. In the local theory, a *globally fibrant model* of a simplicial presheaf or sheaf X is a local weak equivalence $X \rightarrow W$ such that W is globally fibrant.

One says that a simplicial presheaf X on the Nisnevich site is *motivic fibrant* if it is globally fibrant for the Nisnevich topology, and has the right lifting property with respect to all simplicial presheaf inclusions

$$(f, j) : (\mathbb{A}^1 \times A) \cup_A B \rightarrow \mathbb{A}^1 \times B$$

arising from $f : * \rightarrow \mathbb{A}^1$ and all cofibrations $j : A \rightarrow B$. A simplicial presheaf map $g : X \rightarrow Y$ is said to be a *motivic weak equivalence* if it induces a weak equivalence of simplicial sets

$$g^* : \mathbf{hom}(Y, Z) \rightarrow \mathbf{hom}(X, Z)$$

in function complexes for every motivic fibrant object Z . A *cofibration* is a monomorphism of simplicial presheaves, just as in the local theory. A map $p : Z \rightarrow W$ is a *motivic fibration* if it has the right lifting property with respect to all maps which are simultaneously motivic weak equivalences and cofibrations. The homotopy theory arising from the following theorem is effectively the motivic homotopy theory of Morel and Voevodsky:

THEOREM 1.1. *The category $\mathbf{SPre}(Sm|_S)_{Nis}$ of simplicial presheaves on the smooth Nisnevich site of the scheme S , together with the classes of cofibrations, motivic weak equivalences and motivic fibrations, satisfies the axioms for a proper, closed simplicial model category.*

The simplicial structure is the usual one for simplicial presheaves: the *function complex* $\mathbf{hom}(X, Y)$ for simplicial presheaves X and Y has n -simplices consisting of all simplicial presheaf maps $X \times \Delta^n \rightarrow Y$. Most of Theorem 1.1 is derived in [4], meaning that all except the properness assertion is proved there. Morel and Voevodsky demonstrate properness in [14] — an alternative proof appears in Appendix A (Theorem A.5) of this paper. Recall that a closed model category is said to be *proper* if the class of weak equivalences is closed under pullback along fibrations and pushout along cofibrations.

Recall [4] a map $g : X \rightarrow Y$ of simplicial presheaves is a *pointwise weak equivalence* if each map $g : X(U) \rightarrow Y(U)$, U smooth over S , in sections is a weak equivalence of simplicial sets. Similarly, g is said to be a *pointwise fibration* if all maps $g : X(U) \rightarrow Y(U)$ are Kan fibrations.

The standard equivalence of the local homotopy theories for simplicial presheaves and simplicial sheaves is inherited by all localized theories, and induces an equivalence of the homotopy category arising from Theorem 1.1 with the homotopy category for a corresponding closed model structure for simplicial sheaves. This holds quite generally [4, Theorem 1.2], but in the case at hand, more explicit definitions and proofs are quite easy to see: say that a map $p : X \rightarrow Y$ of simplicial sheaves on $(Sm|_S)_{Nis}$ is a *motivic fibration* if it is a global fibration of simplicial sheaves and has the right lifting property with respect to all simplicial sheaf inclusions $(f, j) : (\mathbb{A}^1 \times A) \cup_A B \rightarrow \mathbb{A}^1 \times B$. Then a map is a motivic fibration of simplicial sheaves if and only if it is a motivic fibration in the simplicial presheaf category.

In particular (see the discussion preceding Lemma 1.6) a simplicial sheaf or presheaf Z is motivic fibrant if and only if it is globally fibrant and the projection $U \times \mathbb{A}^1 \rightarrow U$ induces a weak equivalence of simplicial sets $Z(U) \simeq Z(U \times \mathbb{A}^1)$ for all smooth S -schemes U . Thus, if Y is a motivic fibrant simplicial presheaf and the simplicial sheaf $G\tilde{Y}$ is a globally fibrant model of its associated simplicial sheaf \tilde{Y} , then the map $Y \rightarrow G\tilde{Y}$ is a pointwise weak equivalence, so that $G\tilde{Y}$ is motivic fibrant. The two following statements are therefore equivalent for a simplicial sheaf map $g : X \rightarrow Y$:

- 1) the map g induces a weak equivalence $g^* : \mathbf{hom}(Y, Z) \rightarrow \mathbf{hom}(X, Z)$ for all motivic fibrant simplicial sheaves Z ,
- 2) the map g is a motivic weak equivalence in the simplicial presheaf category.

Say that a map g which satisfies either of these properties is a *motivic weak equivalence* of simplicial sheaves. A *cofibration* of simplicial sheaves is a level-wise monomorphism, or a cofibration in the simplicial presheaf category.

THEOREM 1.2. 1) *The category $\mathbf{S}\mathrm{Shv}(Sm|_S)_{Nis}$ of simplicial sheaves on the smooth Nisnevich site of the scheme S , together with the classes of cofibrations, motivic weak equivalences and motivic fibrations, satisfies the axioms for a proper, closed simplicial model category.*

2) *The forgetful functor and the associated sheaf functor together determine an adjoint equivalence of motivic homotopy categories*

$$\mathrm{Ho}(\mathbf{S}\mathrm{Pre}(Sm|_S)_{Nis}) \simeq \mathrm{Ho}(\mathbf{S}\mathrm{Shv}(Sm|_S)_{Nis}).$$

The first part of Theorem 1.2 is proved in [14], and is the basis for their discussion of motivic homotopy theory. The second part says that the simplicial presheaf category gives a second model for motivic homotopy theory. Other models arising from ordinary (not simplicial) sheaves and presheaves are discussed in Appendix B.

Proof of Theorem 1.2. The equivalence of the homotopy categories is trivial, once the first statement is proved. For the closed model structure of part 1), there is really just a factorization axiom to prove. Any map $f : X \rightarrow Y$ of simplicial sheaves has a factorization

$$\begin{array}{ccc} X & \xrightarrow{j} & Z \\ & \searrow f & \downarrow p \\ & & Y \end{array}$$

in the simplicial presheaf category, where j is a motivic weak equivalence and a cofibration and p is a motivic fibration. Then the composite map

$$X \xrightarrow{i} Z \xrightarrow{\eta} \tilde{Z}$$

is a motivic weak equivalence and a cofibration of simplicial sheaves, where η is the associated sheaf map. Form the diagram

$$\begin{array}{ccccc} Z & \xrightarrow{\eta} & \tilde{Z} & \xrightarrow{i} & W \\ & \searrow p & & \swarrow \pi & \\ & & Y & & \end{array}$$

where i is a trivial cofibration and π is a global fibration of simplicial sheaves. This same diagram is a local weak equivalence of cofibrant and globally fibrant objects over Y , and so the map $Z \rightarrow W$ is a homotopy equivalence and therefore a pointwise weak equivalence. Finally (see Lemma 1.5), a motivic fibration of simplicial presheaves can be characterized as a global fibration $X \rightarrow Y$ such that the induced map

$$X(U \times \mathbb{A}^1) \rightarrow X(U) \times_{Y(U)} Y(U \times \mathbb{A}^1)$$

is a weak equivalence of simplicial sets for all smooth S -schemes U . It follows that π is a motivic fibration of simplicial sheaves. \square

1.2 CONTROLLED FIBRANT MODELS

This section is technical, and should perhaps be read in conjunction with some motivation, such as one finds in the proofs of Proposition 2.15 and Corollary 2.16. This material is used to produce generating sets of trivial cofibrations in a variety of contexts. In particular, essential use is made of these ideas for symmetric spectrum objects in the proofs of Theorem 4.2 and Proposition 4.4.

The proofs in [4] and Appendix A hold for arbitrary choices of rational point $* \rightarrow I$ of any simplicial presheaf on any small Grothendieck site \mathcal{C} . At that level of generality, and in the language of [4], suppose α is an infinite cardinal which is an upper bound for the cardinality of the set $\text{Mor}(\mathcal{C})$ of morphisms of \mathcal{C} . Pick a rational point $f : * \rightarrow I$, and suppose that I is α -bounded in the sense that all sets of simplices of all sections $I(U)$ have cardinality bounded above by α . This map f is a cofibration, and we are entitled to a corresponding f -localization homotopy theory for the category $\mathbf{SPre}(\mathcal{C})$, according to the results of [4].

In particular, one says that a simplicial presheaf Z is f -local if Z is globally fibrant, and the map $Z \rightarrow *$ has the right lifting property with respect to all inclusions

$$(* \times L_U \Delta^n) \cup_{(* \times Y)} (I \times Y) \subset I \times L_U \Delta^n \tag{1.1}$$

arising from all subobjects $Y \subset L_U \Delta^n$. It follows that $Z \rightarrow *$ has the right lifting property with respect to all inclusions

$$(* \times B) \cup_{(* \times A)} (I \times A) \subset I \times B$$

arising from cofibrations $A \rightarrow B$. The map

$$f^* : \mathbf{hom}(I \times Y, Z) \rightarrow \mathbf{hom}(* \times Y, Z)$$

is therefore a weak equivalence for all simplicial presheaves Y if Z is f -local, and so all induced maps

$$\mathbf{hom}(I \times L_U \Delta^n, Z) \rightarrow \mathbf{hom}((I \times Y) \cup_{(* \times Y)} (* \times L_U \Delta^n), Z)$$

are trivial fibrations of simplicial sets.

A simplicial presheaf map $g : X \rightarrow Y$ is an f -equivalence if the induced map

$$g^* : \mathbf{hom}(Y, Z) \rightarrow \mathbf{hom}(X, Z)$$

is a weak equivalence of simplicial sets for all f -local objects Z . The original map $f : * \rightarrow I$ is an f -equivalence, and the maps

$$f \times 1_Y : * \times Y \rightarrow I \times Y$$

and the inclusions

$$(* \times B) \cup_{(* \times A)} (I \times A) \subset I \times B$$

are f -equivalences. A map $p : X \rightarrow Y$ is an f -fibration if it has the right lifting property with respect to all cofibrations of simplicial presheaves which are f -equivalences.

It is a consequence of Theorem 4.6 of [4] that the category $\mathbf{SPre}(\mathcal{C})$ with the cofibrations, f -equivalences and f -fibrations, together satisfy the axioms for a closed simplicial model category. This result specializes to the closed model structure of Theorem 1.1 in the case of simplicial presheaves on the smooth Nisnevich site of S . Note as well that, very generally, the f -local objects coincide with the f -fibrant objects.

Pick cardinals λ and κ such that

$$\lambda = 2^\kappa > \kappa > 2^\alpha.$$

As part of the proof of [4, Theorem 4.6], it is shown that there is a functor $X \mapsto \mathcal{L}X$ defined on simplicial presheaves X together with a natural transformation $\eta_X : X \rightarrow \mathcal{L}X$ which is an f -fibrant model for X , such that the following properties hold:

L1: \mathcal{L} preserves local weak equivalences.

L2: \mathcal{L} preserves cofibrations.

L3: Let β be any cardinal with $\beta \geq \alpha$. Let $\{X_j\}$ be the filtered system of sub-objects of X which are β -bounded. Then the map

$$\varinjlim \mathcal{L}(X_j) \rightarrow \mathcal{L}X$$

is an isomorphism.

L4: Let γ be an ordinal number of cardinality strictly greater than 2^α . Let $X : \gamma \rightarrow \mathbf{S}$ be a diagram of cofibrations so that for all limit ordinals $s < \gamma$ the induced map

$$\varinjlim_{t < s} X(t) \rightarrow X(s)$$

is an isomorphism. Then $\varinjlim_{t < \gamma} \mathcal{L}(X(t)) \cong \mathcal{L}(\varinjlim_{t < \gamma} X(t))$.

L5: If X is λ -bounded, then $\mathcal{L}X$ is λ -bounded.

L6: Let Y, Z be two subobjects of X . Then

$$\mathcal{L}(Y) \cap \mathcal{L}(Z) = \mathcal{L}(Y \cap Z)$$

in $\mathcal{L}X$.

L7: The functor \mathcal{L} is continuous; that is, it extends to a natural morphism of simplicial sets

$$\mathcal{L} : \mathbf{HOM}(X, Y) \rightarrow \mathbf{HOM}(\mathcal{L}X, \mathcal{L}Y)$$

compatible with composition.

In fact, the map $\eta_X : X \rightarrow \mathcal{L}X$ is a cofibration and an f -weak equivalence, which is constructed by a transfinite small object argument. The size of the construction, or rather the ordinal number that defines $\mathcal{L}X$ as a filtered colimit, is the cardinal κ (see [4, p.42]).

The demonstration of the statement L7 further involves the construction of a functorial pairing

$$\phi : \mathcal{L}X \times L \rightarrow \mathcal{L}(X \times K)$$

for simplicial presheaves X and simplicial sets L , and which satisfies a short list of compatibility conditions. This pairing induces a natural pointed map

$$\phi : \mathcal{L}X \wedge K \rightarrow \mathcal{L}(X \wedge K)$$

for pointed simplicial presheaves X and pointed simplicial sets K such that the following properties hold:

L8: the map

$$\phi : (\mathcal{L}X) \wedge \Delta_+^0 \rightarrow \mathcal{L}(X \wedge \Delta_+^0)$$

is the canonical isomorphism,

L9: the triangle

$$\begin{array}{ccc} X \wedge K & \xrightarrow{\eta_X \wedge K} & (\mathcal{L}X) \wedge K \\ & \searrow \eta_{X \wedge K} & \downarrow \phi \\ & & \mathcal{L}(X \wedge K) \end{array}$$

commutes, and

L10: the diagram

$$\begin{array}{ccc} (\mathcal{L}X) \wedge K \wedge L & \xrightarrow{\phi} & \mathcal{L}(X \wedge K \wedge L) \\ \phi \wedge L \downarrow & \nearrow \phi & \\ (\mathcal{L}(X \wedge K)) \wedge L & & \end{array}$$

commutes.

These statements are analogues of the standard properties for the unpointed pairing, and are consequences of same. In fact, nothing in the argument prevents L and K from being arbitrary simplicial presheaves, and we shall work with the more general pairing.

Specializing this construction to the case of pointed simplicial presheaves on $(Sm|_S)_{Nis}$ gives *controlled fibrant model* construction $\eta_X : X \rightarrow \mathcal{L}X$ for

a simplicial presheaf X . The construction is controlled in the sense that the cardinality of $\mathcal{L}X$ has a specific bound if the cardinality of the original object X is well behaved, by L5. Also, the functor $X \mapsto \mathcal{L}X$ is compatible with smash product pairings in the sense that every pointed simplicial presheaf map $\sigma : X \wedge T \rightarrow Y$ induces a commutative diagram

$$\begin{array}{ccc}
 X \wedge T & \xrightarrow{\sigma} & Y \\
 \eta_X \wedge 1_T \downarrow & \searrow \eta_{X \wedge T} & \downarrow \eta_Y \\
 \mathcal{L}X \wedge T & \xrightarrow{\phi} \mathcal{L}(X \wedge T) \xrightarrow{\mathcal{L}\sigma} & \mathcal{L}Y
 \end{array}
 \tag{1.2}$$

1.3 NISNEVICH DESCENT

We shall need an unstable variant of the Nisnevich descent theorem [15]. The version of this result given in [11, p.296] says if a presheaf of spectra F on the Nisnevich site satisfies the *cd*-excision property, then any stably fibrant model $j : F \rightarrow GF$ for the Nisnevich topology is a stable equivalence in all sections.

A simplicial presheaf Z is said to have the *cd-excision property* (aka. B.G. property in [14]) if any *elementary Cartesian square*

$$\begin{array}{ccc}
 U \times_X V & \longrightarrow & V \\
 \downarrow & & \downarrow p \\
 U & \xrightarrow{i} & X
 \end{array}
 \tag{1.3}$$

of smooth schemes over k with p étale, i an open immersion and $p^{-1}(X - U) \cong X - U$ induces a homotopy Cartesian diagram of simplicial sets

$$\begin{array}{ccc}
 Z(X) & \longrightarrow & Z(U) \\
 \downarrow & & \downarrow \\
 Z(V) & \longrightarrow & Z(U \times_X V)
 \end{array}$$

The *cd*-excision property for presheaves of spectra is the stable analog of this requirement.

The unstable Nisnevich descent theorem is the following:

THEOREM 1.3. *A simplicial presheaf Z on the site $(Sm|_S)_{Nis}$ has the *cd*-excision property if and only if any globally fibrant model $j : Z \rightarrow GZ$ for Z induces weak equivalences of simplicial sets $Z(U) \rightarrow GZ(U)$ in all sections.*

This is the simplicial presheaf analogue of a result for simplicial sheaves [14, 3.1.16].

Proof. Morel and Voevodsky point out that any globally fibrant simplicial sheaf has the *cd*-excision property [14, 3.1.15] and they show [14, 3.1.18] that if a map

$f : X \rightarrow Y$ is a local weak equivalence of simplicial presheaves and both have the cd -excision property, then f consists of weak equivalences $f : X(U) \rightarrow Y(U)$ in all sections.

Any simplicial sheaf which is globally fibrant within the simplicial sheaf category is also globally fibrant as a simplicial presheaf. It follows that the canonical map $\eta : Z \rightarrow \tilde{Z}$ taking values in the associated sheaf \tilde{Z} gives rise to a diagram

$$\begin{array}{ccc} Z & \xrightarrow{\eta} & \tilde{Z} \\ j_Z \downarrow & & \downarrow i_{\tilde{Z}} \\ GZ & \xrightarrow{\eta_*} & G\tilde{Z} \end{array}$$

where all maps are local weak equivalences and $G\tilde{Z}$ is globally fibrant in the simplicial sheaf category. In particular, η_* is a local weak equivalence of globally fibrant simplicial presheaves, and hence consists weak equivalences $GZ(U) \rightarrow G\tilde{Z}(U)$ in all sections, since weakly equivalent globally fibrant models are homotopy equivalent. It follows in particular that any globally fibrant simplicial presheaf has the cd -excision property. Thus, if Z has the cd -excision property, any globally fibrant model consists of weak equivalences $Z(U) \rightarrow GZ(U)$ in sections, by the Morel-Voevodsky result, and the converse is obvious. \square

All of the hard work in the proof of Theorem 1.3 was done by Morel and Voevodsky. The original stable form of the Nisnevich descent theorem for the smooth site $(Sm|_S)_{Nis}$ is a corollary:

COROLLARY 1.4. *Suppose that Z is a presheaf of spectra on the smooth Nisnevich site $(Sm|_S)_{Nis}$. Then a stably fibrant model $j : Z \rightarrow GZ$ consists of stable equivalences $Z(U) \rightarrow GZ(U)$ in all sections if and only if the presheaf of spectra Z satisfies the (stable) cd -excision property.*

Proof. The presheaf of spectra Z satisfies the stable cd -excision property if and only if any elementary Cartesian diagram (1.3) induces a homotopy Cartesian diagram

$$\begin{array}{ccc} Z(X) & \longrightarrow & Z(U) \\ \downarrow & & \downarrow \\ Z(V) & \longrightarrow & Z(U \times_X V) \end{array}$$

of spectra with respect to stable equivalence. It follows that a presheaf of spectra Z has the stable cd -excision property if and only if each of the simplicial presheaves $QEx^\infty Z^n$ has the cd -excision property. The maps $QEx^\infty Z \rightarrow GZ$ are level weak equivalences of presheaves of Ω -spectra and all simplicial

presheaves GZ^n are globally fibrant. It follows that Z has the stable cd -excision property if and only if all of the maps in sections $Q\text{Ex}^\infty Z^n(U) \rightarrow GZ^n(U)$ are weak equivalences of pointed simplicial sets, and this holds if and only if all maps $Z(U) \rightarrow GZ(U)$ are stable equivalences of spectra. \square

The cd -excision property is preserved by taking filtered colimits. Thus, if

$$Z_1 \rightarrow Z_2 \rightarrow Z_3 \rightarrow \cdots$$

is an inductive system of maps between simplicial presheaves which are globally fibrant for the Nisnevich topology, then any choice of globally fibrant model

$$j : \varinjlim Z_i \rightarrow G(\varinjlim Z_i)$$

for the Nisnevich topology is a pointwise weak equivalence.

Let's return briefly to a gross level of generality. Suppose that X and Y are simplicial presheaves on a site \mathcal{C} . For $U \in \mathcal{C}$, write $\mathcal{C} \downarrow U$ for the category whose objects are morphism $V \rightarrow U$ and whose morphisms are commutative triangles. There is a standard functor $Q_U : \mathcal{C} \downarrow U \rightarrow \mathcal{C}$ which is defined by taking the morphism

$$\begin{array}{ccc} V_1 & \xrightarrow{\alpha} & V_2 \\ & \searrow & \swarrow \\ & U & \end{array}$$

to the morphism $\alpha : V_1 \rightarrow V_2$ of \mathcal{C} . Write $X|_U$ for the composite of the simplicial presheaf X with the functor Q_U . Any map $\phi : V \rightarrow U$ of \mathcal{C} defines a functor $\phi_* : \mathcal{C} \downarrow V \rightarrow \mathcal{C} \downarrow U$ on objects $V_1 \rightarrow V$ by composition with ϕ , and obviously $Q_U \cdot \phi_* = Q_V$.

The *internal hom complex* $\mathbf{Hom}(X, Y)$ is a simplicial presheaf on \mathcal{C} which is defined by

$$\mathbf{Hom}(X, Y)(U) = \mathbf{hom}(X|_U, Y|_U).$$

Evaluation in U -sections defines natural maps

$$ev_U : \mathbf{hom}(X|_U, Y|_U) \times X(U) \rightarrow Y(U)$$

which together give a natural *evaluation map*

$$ev : \mathbf{Hom}(X, Y) \times X \rightarrow Y.$$

This evaluation map defines a natural bijection

$$\mathbf{hom}(Z \times X, Y) \cong \mathbf{hom}(Z, \mathbf{Hom}(X, Y)),$$

or exponential law, for simplicial presheaves X , Y and Z on an arbitrary Grothendieck site \mathcal{C} .

The main homotopical fact about internal hom complexes is the following expanded version of Quillen's axiom SM7:

LEMMA 1.5. *Suppose that $i : A \rightarrow B$ is a cofibration and that $p : X \rightarrow Y$ is a global fibration of simplicial presheaves. Then the induced map*

$$(i^*, p_*) : \mathbf{Hom}(B, X) \rightarrow \mathbf{Hom}(A, X) \times_{\mathbf{Hom}(A, Y)} \mathbf{Hom}(B, Y)$$

is a global fibration, which is trivial if either i or p is a local weak equivalence.

Proof. By adjointness, the claim follows from the assertion that the cofibration $i : A \rightarrow B$ and another cofibration $j : C \rightarrow D$ together determine a cofibration

$$(A \times D) \cup_{(A \times C)} (B \times C) \hookrightarrow B \times D$$

which is a local weak equivalence if either i or j is a local weak equivalence. This is checked stalkwise, or with a Boolean localization argument [12]. \square

Recall that a motivic fibrant simplicial presheaf Z on $(Sm|_S)_{Nis}$ is an object which is globally fibrant for the Nisnevich topology and has the right lifting property with respect to all simplicial presheaf inclusions

$$(\mathbb{A}^1 \times A) \cup_A B \xrightarrow{(f, j)} \mathbb{A}^1 \times B$$

arising from $f : * \rightarrow \mathbb{A}^1$ and all cofibrations $j : A \rightarrow B$. The lifting property is equivalent to the assertion that the induced global fibration

$$f^* : \mathbf{Hom}(\mathbb{A}^1, Z) \rightarrow \mathbf{Hom}(*, Z) \cong Z$$

is a trivial global fibration. It follows that a simplicial presheaf Z is motivic fibrant if and only if Z is globally fibrant and all projections $U \times \mathbb{A}^1 \rightarrow U$ induce weak equivalences of simplicial sets $Z(U) \rightarrow Z(U \times \mathbb{A}^1)$. This observation is essentially well known, and was proved by Morel and Voevodsky in [14].

We can now prove the following:

LEMMA 1.6. *Suppose given an inductive system*

$$Z_1 \rightarrow Z_2 \rightarrow Z_3 \rightarrow \dots$$

of motivic fibrant simplicial presheaves on $(Sm|_S)$, and let

$$j : \varinjlim Z_i \rightarrow G(\varinjlim Z_i)$$

be a choice of globally fibrant model for the Nisnevich topology. Then the simplicial presheaf $G(\varinjlim Z_i)$ is motivic fibrant.

Proof. The map j is a pointwise weak equivalence by Nisnevich descent, and the the simplicial presheaf maps

$$pr^* : Z_i(U) \rightarrow Z_i(U \times \mathbb{A}^1)$$

induce a weak equivalence on the filtered colimit, and so $G(\varinjlim Z_i)$ is motivic fibrant. \square

We shall make constant use of the following variant of Lemma 1.6:

COROLLARY 1.7. *Suppose that $X_1 \rightarrow X_2 \rightarrow \dots$ is an inductive system of motivic fibrant simplicial presheaves on $(Sm|_S)_{Nis}$. Then any motivic fibrant model*

$$j : \varinjlim X_i \rightarrow Z$$

is a pointwise weak equivalence.

1.4 FLASQUE SIMPLICIAL PRESHEAVES

Say that a simplicial presheaf X on $(Sm|_S)_{Nis}$ is *flasque* if X is a presheaf of Kan complexes and every finite collection $U_i \hookrightarrow U, i = 1, \dots, n$ of subschemes of a scheme U induces a Kan fibration

$$X(U) \cong \mathbf{hom}(U, X) \xrightarrow{i^*} \mathbf{hom}(\cup_{i=1}^n U_i, X).$$

Here, the union is taken in the presheaf category, so that the simplicial set

$$\mathbf{hom}(\cup_{i=1}^n U_i, X)$$

is an iterated fibre product of the simplicial sets $X(U_i)$.

Every globally fibrant simplicial presheaf is flasque, and the class of flasque simplicial presheaves is closed under filtered colimits. Note that the condition for X to be flasque says that the map $X(U) \rightarrow X(V)$ associated to the singleton set consisting of a subscheme $V \hookrightarrow U$ is a Kan fibration.

Lifting problems

$$\begin{array}{ccc} \Lambda_k^n & \longrightarrow & \mathbf{hom}(U, X) \\ \downarrow & \nearrow & \downarrow i^* \\ \Delta^n & \longrightarrow & \mathbf{hom}(\cup_{i=1}^n U_i, X) \end{array}$$

and their solutions are equivalent to diagrams of simplicial presheaf maps

$$\begin{array}{ccc} (\cup_{i=1}^n U_i \times \Delta^n) \cup_{(\cup_{i=1}^n U_i \times \Lambda_k^n)} U \times \Lambda_k^n & \longrightarrow & X \\ \downarrow & \nearrow & \\ U \times \Delta^n & & \end{array}$$

One says more generally that a map $p : X \rightarrow Y$ of simplicial presheaves is flasque if it is a pointwise fibration and has the right lifting property with respect to all maps

$$(\cup_{i=1}^n U_i \times \Delta^n) \cup_{(\cup_{i=1}^n U_i \times \Lambda_k^n)} U \times \Lambda_k^n \hookrightarrow U \times \Delta^n \tag{1.4}$$

arising from all finite collections $U_i, i = 1, \dots, n$ of subschemes of schemes U . Equivalently, the map p is flasque if and only if the simplicial set map

$$\mathbf{hom}(U, X) \xrightarrow{(i^*, p_*)} \mathbf{hom}(\cup_{i=1}^n U_i, X) \times_{\mathbf{hom}(\cup_{i=1}^n U_i, Y)} \mathbf{hom}(U, Y)$$

is a Kan fibration.

Note in particular that a simplicial presheaf X is flasque if and only if the map $X \rightarrow *$ is flasque. The class of flasque maps is clearly stable under pullback.

One also has the following:

LEMMA 1.8. *Suppose that $p : X \rightarrow Y$ is a flasque map of simplicial presheaves, and suppose that $j : A \hookrightarrow B$ is an inclusion of schemes. Then the induced map*

$$\mathbf{Hom}(B, X) \xrightarrow{(j^*, p_*)} \mathbf{Hom}(A, X) \times_{\mathbf{Hom}(A, Y)} \mathbf{Hom}(B, Y)$$

is flasque.

Proof. The map in U -sections induced by (j^*, p_*) is isomorphic to the map

$$X(B \times U) \rightarrow X(A \times U) \times_{Y(A \times U)} Y(B \times U)$$

which is induced by restriction along the subscheme $A \times U$ of $B \times U$. This map is a Kan fibration since p is flasque, so that (j^*, p_*) is a pointwise Kan fibration.

Any lifting problem for the cofibration (1.4) and the map (j^*, p_*) is equivalent to the extension problem for the map $p : X \rightarrow Y$ corresponding to the collection of subschemes consisting of $U_i \times B, i = 1, \dots, n$, as well as $U \times A$ of the scheme $U \times B$. □

COROLLARY 1.9. *Suppose that X is a flasque simplicial presheaf and that B is a scheme. Then $\mathbf{Hom}(B, X)$ is flasque.*

Proof. If X is flasque, then $\mathbf{Hom}(\emptyset, X)$ is the constant simplicial presheaf on the Kan complex $X(\emptyset)$, and is therefore flasque. The inclusion $\emptyset \subset B$ induces a flasque map $\mathbf{Hom}(B, X) \rightarrow \mathbf{Hom}(\emptyset, X)$, by Lemma 1.8, so that $\mathbf{Hom}(B, X)$ is flasque. □

COROLLARY 1.10. *Suppose that X is a pointed flasque simplicial presheaf and that $j : A \hookrightarrow B$ is an inclusion of schemes. Then $\mathbf{Hom}_*(B/A, X)$ is flasque.*

Proof. $\mathbf{Hom}_*(B/A, X)$ is the fibre of the flasque map $j^* : \mathbf{Hom}(B, X) \rightarrow \mathbf{Hom}(A, X)$. □

LEMMA 1.11. *Suppose that the simplicial presheaf X is flasque, and that $j : K \hookrightarrow L$ is an inclusion of simplicial sets. Then the simplicial presheaf map*

$$j^* : \mathbf{hom}(L, X) \rightarrow \mathbf{hom}(K, X)$$

is flasque.

Proof. Write $X^L = \mathbf{hom}(L, X)$. We must solve the lifting problem

$$\begin{array}{ccc}
 \Lambda_k^n & \xrightarrow{\quad} & \mathbf{hom}(U, X^L) \\
 \downarrow & \nearrow \text{dotted} & \downarrow (i^*, j^*) \\
 \Delta^n & \xrightarrow{\quad} & \mathbf{hom}(\cup_i U_i, X^L) \times_{\mathbf{hom}(\cup_i U_i, X^K)} \mathbf{hom}(U, X^K)
 \end{array}$$

An adjointness argument says that this problem is isomorphic to the lifting problem

$$\begin{array}{ccc}
 \Lambda_k^n & \xrightarrow{\quad} & \mathbf{hom}(U, X)^L \\
 \downarrow & \nearrow \text{dotted} & \downarrow (i^*, j^*) \\
 \Delta^n & \xrightarrow{\quad} & \mathbf{hom}(\cup_i U_i, X)^L \times_{\mathbf{hom}(\cup_i U_i, X)^K} \mathbf{hom}(U, X)^K
 \end{array}$$

But i^* is a fibration, so the lifting problem is solved by SM7 for simplicial sets. □

LEMMA 1.12. *Suppose that $g : A \rightarrow B$ is a map of schemes, and that X is a pointed flasque simplicial presheaf. Let M_g denote the mapping cylinder for g in the simplicial presheaf category, and let $C_g = M_g/A$ be the homotopy cofibre. Then the standard cofibration $j : A \hookrightarrow M_g$ associated to g induces a flasque map*

$$j^* : \mathbf{Hom}(M_g, X) \rightarrow \mathbf{Hom}(A, X).$$

The simplicial presheaves $\mathbf{Hom}(M_g, X)$ and $\mathbf{Hom}_*(C_g, X)$ are flasque.

Proof. The second claim follows from the first. The mapping cylinder M_g is defined by a pushout diagram

$$\begin{array}{ccc}
 A \sqcup A & \xrightarrow{g \sqcup 1_A} & B \sqcup A \\
 (d^0, d^1) \downarrow & & \downarrow d_* \\
 A \times \Delta^1 & \longrightarrow & M_g
 \end{array}$$

and the map j is the composite

$$A \xrightarrow{in_R} B \sqcup A \xrightarrow{d_*} M_g.$$

The map $d = (d^0, d^1)$ induces a flasque map

$$\mathbf{Hom}(A \times \Delta^1, X) \xrightarrow{d^*} \mathbf{Hom}(A \times \partial\Delta^1, X),$$

by Lemma 1.11 since $\mathbf{Hom}(A, X)$ is flasque by Corollary 1.9. Flasque maps are closed under pullback, so the map

$$d^* : \mathbf{Hom}(M_g, X) \rightarrow \mathbf{Hom}(B \sqcup A, X)$$

is flasque. The inclusion $in_R : A \rightarrow B \sqcup A$ induces the projection map

$$\mathbf{Hom}(B, X) \times \mathbf{Hom}(A, X) \rightarrow \mathbf{Hom}(A, X)$$

which is flasque since the simplicial presheaf $\mathbf{Hom}(B, X)$ is flasque. Flasque maps are closed under composition, so we're done. \square

EXAMPLE 1.13. Suppose that T is the quotient $\mathbb{A}^1/(\mathbb{A}^1 - 0)$, and suppose that X is a flasque simplicial presheaf. Then the object $\mathbf{Hom}_*(T, X)$ is the fibre of the flasque map

$$\mathbf{Hom}(\mathbb{A}^1, X) \xrightarrow{i^*} \mathbf{Hom}(\mathbb{A}^1 - 0, X),$$

which is induced by the inclusion $i : \mathbb{A}^1 - 0 \subset \mathbb{A}^1$, so that $\mathbf{Hom}_*(T, X)$ is flasque by Corollary 1.10.

There is an isomorphism

$$\mathbf{Hom}(U, X)(V) \cong X(U \times V),$$

which is natural for all objects U and V of the underlying site. It follows that there is a fibre sequence

$$\mathbf{Hom}_*(T, X)(U) \rightarrow X(\mathbb{A}^1 \times U) \rightarrow X((\mathbb{A}^1 - 0) \times U)$$

if X is flasque, so that the functor $\mathbf{Hom}_*(T, _)$ preserves pointwise weak equivalences of flasque simplicial presheaves. It follows as well that the functor $\mathbf{Hom}_*(T, _)$ preserves filtered colimits of simplicial presheaves.

EXAMPLE 1.14. Suppose that K is a finite pointed simplicial set, identified with a constant simplicial presheaf. Then there is an isomorphism

$$\mathbf{Hom}_*(K, X) \cong \mathbf{hom}_*(K, X),$$

and the functor $\mathbf{hom}_*(K, _)$ is flasque by Lemma 1.11. The functor $\mathbf{hom}_*(K, _)$ preserves pointwise weak equivalences of pointed simplicial presheaves consisting of Kan complexes, so that it preserves pointwise weak equivalences of flasque simplicial presheaves. The functor $\mathbf{hom}(K, _)$ commutes with all filtered colimits since K is finite.

2 MOTIVIC STABLE CATEGORIES

In this section, we work exclusively with spectrum objects defined by T on the smooth Nisnevich site $(Sm|_S)_{Nis}$, where T is a pointed simplicial presheaf

which is compact in the sense described below; examples of such T include the quotient $\mathbb{A}^1/(\mathbb{A}^1 - 0)$ and all constant simplicial presheaves associated to pointed finite simplicial sets. The object of the section is to develop a stable homotopy theory of spectrum objects defined by T , or T -spectra, in the motivic context. The motivic stable category of Morel and Voevodsky arises as a special case, as does a motivic stable homotopy theory for ordinary S^1 -spectra.

WARNING: We shall work almost entirely within the motivic closed model structure henceforth. In particular, all fibrations will be motivic fibrations and all weak equivalences will be motivic weak equivalences, unless explicit mention is made to the contrary.

Formally, if T is a pointed simplicial presheaf, then a T -spectrum X consists of pointed simplicial presheaves X^n , $n \geq 0$, and pointed maps $\sigma : T \wedge X^n \rightarrow X^{n+1}$. The maps σ are called *bonding maps*; it is a fact of life (see Section 3.4) that it matters whether one writes $T \wedge X^n$ or $X^n \wedge T$ in the description of these maps — I shall always display them by smashing with T on the left.

There is an obvious category $\mathbf{Spt}_T(\mathit{Sm}|_S)_{\mathit{Nis}}$ of T -spectra. If T is the Morel-Voevodsky object $\mathbb{A}^1/(\mathbb{A}^1 - 0)$ then the corresponding category of T -spectra is the basis for the motivic stable category.

2.1 THE LEVEL STRUCTURES

For arbitrary pointed simplicial presheaves T , there are two preliminary closed model structures on T -spectra which are analogous to the level fibration and level cofibration structures for ordinary presheaves of spectra (aka. S^1 -spectra in this language), but where the level equivalences are motivic weak equivalences.

Say that a map $f : X \rightarrow Y$ of T -spectra is a

- 1) *level cofibration* if all component maps $f : X^n \rightarrow Y^n$ are cofibrations of simplicial presheaves,
- 2) *level fibration* if all component maps $f : X^n \rightarrow Y^n$ are fibrations (ie. motivic fibrations),
- 3) *level equivalence* if all component maps $f : X^n \rightarrow Y^n$ are motivic weak equivalences

A *cofibration* is a map which has the left lifting property with respect to all maps which are level fibrations and level weak equivalences. An *injective fibration* is a map which has the right lifting property with respect to all maps which are level cofibrations and level equivalences.

LEMMA 2.1. 1) *The category $\mathbf{Spt}_T((\mathit{Sm}|_S)_{\mathit{Nis}})$ of T -spectra, together with the classes of cofibrations, level equivalences and level fibrations, satisfies the axioms for a proper closed simplicial model category.*

- 2) The category $\mathbf{Spt}_T((Sm|_S)_{Nis})$, together with the classes of level cofibrations, level equivalences and injective fibrations, satisfies the axioms for a proper closed simplicial model category.

Proof. For the first part (following [2]), suppose that a map $i : A \rightarrow B$ satisfies

- a) $i^0 : A^0 \rightarrow B^0$ is a cofibration of simplicial presheaves, and
- b) each map $i_* : T \wedge B^n \cup_{T \wedge A^n} A^{n+1} \rightarrow B^{n+1}$ is a cofibration.

Then i is a cofibration. Further, if i^0 and all maps i_* as above are cofibrations and equivalences, then i is a level equivalence as well as a cofibration. These two observations are the basis of proof for the factorization axiom CM5. Further, it's a consequence of the factorization axiom that every cofibration satisfies the two properties above. The axiom CM4 follows, and the rest of the axioms are trivial.

For the second statement, suppose that α is an infinite cardinal which is an upper bound for the cardinality of the set of morphisms $\text{Mor}((Sm|_S)_{Nis})$. As in [4], choose a cardinal $\kappa > 2^\alpha$ and set $\lambda = 2^\kappa$. The axioms sE1 – sE7 of [4] and their consequences apply to categories of T -spectra. We verify the bounded cofibration axiom sE7; the remaining axioms are easily verified, giving statement 2) according to the methods of [4].

Recall that the classes of cofibrations and equivalences of simplicial presheaves on $(Sm|_S)_{Nis}$ together satisfy the bounded cofibration condition for the cardinal λ in the sense that, given a diagram

$$\begin{array}{ccc} & X & \\ & \downarrow i & \\ A & \xrightarrow{j} & Y \end{array} \tag{2.1}$$

such that the cofibration i is an equivalence and the subobject A of Y is λ -bounded, there is a λ -bounded subobject B of Y with $A \subset B$, with $B \cap X \hookrightarrow B$ an equivalence.

Suppose now that the objects and maps of diagram (2.1) are in the category of T -spectra, where i is a level equivalence and a level cofibration and A is λ -bounded. There is a simplicial presheaf B^0 with $A^0 \subset B^0 \subset Y^0$ such that B^0 is λ -bounded and the cofibration $B^0 \cap X^0 \hookrightarrow B^0$ is an equivalence. Write j' for the inclusion $B^0 \hookrightarrow Y^0$ and use the diagram

$$\begin{array}{ccc} T \wedge A^0 & \longrightarrow & T \wedge B^0 \\ \sigma \downarrow & & \downarrow \sigma \cdot (T \wedge j') \\ A^1 & \xrightarrow{j} & Y^1 \end{array}$$

to show that there is a λ -bounded subobject $\overline{A}^1 \subset Y^1$ such that the map

$$A^1 \cup_{T \wedge A^0} T \wedge B^0 \rightarrow Y^1$$

factors through \overline{A}^1 . There is a λ -bounded subobject $B^1 \subset Y^1$ with $\overline{A}^1 \subset B^1$ such that the cofibration $B^1 \cap X^1 \hookrightarrow B^1$ is an equivalence. This is the beginning of an inductive construction which produces a λ -bounded subobject B of the T -spectrum Y with $A \subset B$ such that the level cofibration $B \cap X \hookrightarrow B$ is a level equivalence. \square

Insofar as the factorization axiom CM5 in part (2) of Lemma 2.1 is covertly proved by using a small object argument, there is a natural injective model construction: there is a natural map of T -spectra $i_X : X \rightarrow IX$, such that i_X is a level cofibration and a level equivalence, and IX is injective. More generally, any level equivalence $X \rightarrow Y$ with Y injective is said to be an *injective model* for X .

There is a natural *level fibrant model* $j_X : X \rightarrow JX$, meaning that j_X is a cofibration and a level equivalence and JX is level fibrant. This can be constructed directly from the small object arguments, or by using the controlled fibrant object construction $X \mapsto \mathcal{L}X$ of [4] (see also Section 1.2). Note as well that every injective object is level fibrant.

2.2 COMPACT OBJECTS

Say that a simplicial presheaf X on $(Sm|_S)_{Nis}$ is *motivic flasque* if

- 1) X is flasque, and
- 2) every map $X(U) \rightarrow X(\mathbb{A}^1 \times U)$ induced by the projection $\mathbb{A}^1 \times U \rightarrow U$ is a weak equivalence of simplicial sets.

Every motivic fibrant simplicial presheaf on $(Sm|_S)_{Nis}$ is motivic flasque, and the class of motivic flasque simplicial presheaves is closed under filtered colimits.

A pointed simplicial presheaf T on the smooth Nisnevich site is said to be *compact* if the following conditions hold:

- C1: All inductive systems $Y_1 \rightarrow Y_2 \rightarrow \dots$ of pointed simplicial presheaves induce isomorphisms

$$\mathbf{Hom}_*(T, \varinjlim Y_i) \cong \varinjlim \mathbf{Hom}_*(T, Y_i).$$

- C2: If X is motivic flasque, then so is $\mathbf{Hom}_*(T, X)$.

- C3: The functor $\mathbf{Hom}_*(T, _)$ takes pointwise weak equivalences of motivic flasque simplicial presheaves to pointwise weak equivalences.

The following result generates examples of compact simplicial presheaves:

LEMMA 2.2. 1) If $A \hookrightarrow B$ is an inclusion of schemes, then the quotient B/A is compact.

2) All finite pointed simplicial sets K are compact.

3) All pointed schemes U in the underlying site $(Sm|_S)_{Nis}$ are compact.

4) If T_1 and T_2 are compact, then $T_1 \vee T_2$ and $T_1 \wedge T_2$ are compact.

5) If $g : T_1 \rightarrow T_2$ is a map of compact simplicial presheaves, then the pointed mapping cylinder M_g and the homotopy cofibre C_g are compact.

Proof. If X is motivic flasque, then $\mathbf{Hom}_*(B/A, X)$ is flasque by Corollary 1.10. We also know that there is an isomorphism

$$\mathbf{Hom}(B, X)(V) \cong X(B \times V)$$

and a pointwise fibre sequence

$$\mathbf{Hom}_*(B/A, X) \rightarrow \mathbf{Hom}(B, X) \rightarrow \mathbf{Hom}(A, X) \tag{2.2}$$

All maps

$$\mathbf{Hom}(B, X)(V) \rightarrow \mathbf{Hom}(B, X)(V \times \mathbb{A}^1)$$

induced by projection are weak equivalences of simplicial sets. It follows that $\mathbf{Hom}_*(B/A, X)$ is motivic flasque. The functor $X \mapsto \mathbf{Hom}_*(B/A, X)$ preserves filtered colimits of simplicial presheaves. The fibre sequences (2.2) imply that the functor $\mathbf{Hom}_*(B/A, \)$ preserves pointwise weak equivalences of motivic flasque simplicial presheaves, giving 1).

Statement 2) is proved by first observing that there is a natural isomorphism

$$\mathbf{Hom}_*(K, X) \cong \mathbf{hom}_*(K, X).$$

The functor $X \mapsto \mathbf{hom}_*(K, X)$ preserves filtered colimits since K is a finite simplicial set. The statement C3 is trivial, and C2 follows from Lemma 1.11, and the functor $X \mapsto \mathbf{hom}_*(K, X)$ preserves pointwise weak equivalences of pointed presheaves of Kan complexes.

Statement 3) is a consequence of statement 1), and the smash product part of statement 4) is an adjointness argument.

Suppose that X is motivic flasque. The diagram

$$\begin{array}{ccc} T_1 \vee T_1 & \longrightarrow & T_1 \vee T_2 \\ \downarrow & & \downarrow \\ T_1 \wedge \Delta_+^1 & \longrightarrow & M_g \end{array}$$

that defines the pointed mapping cylinder M_g induces a pullback diagram

$$\begin{array}{ccc}
 \mathbf{Hom}_*(M_g, X) & \longrightarrow & \mathbf{Hom}_*(T_1 \wedge \Delta_+^1, X) \\
 \downarrow & & \downarrow \\
 \mathbf{Hom}_*(T_1 \vee T_2, X) & \longrightarrow & \mathbf{Hom}_*(T_1 \vee T_1, X)
 \end{array} \tag{2.3}$$

and the map

$$\mathbf{Hom}_*(T_1 \wedge \Delta_+^1, X) \rightarrow \mathbf{Hom}_*(T_1 \vee T_1, X)$$

is flasque, by the pointed version of Lemma 1.11. $\mathbf{Hom}_*(M_g, X)$ is therefore flasque. The composite

$$\mathbf{Hom}_*(M_g, X) \rightarrow \mathbf{Hom}_*(T_1 \vee T_2, X) \rightarrow \mathbf{Hom}(T_2, X)$$

is also flasque, and so the pointwise homotopy fibre $\mathbf{Hom}_*(C_g, X)$ is flasque. The objects other than $\mathbf{Hom}_*(M_g, X)$ in the pointwise fibre square (2.3) take the projections $U \times \mathbb{A}^1 \rightarrow U$ to weak equivalences. Properness for simplicial sets therefore implies that the simplicial presheaves $\mathbf{Hom}_*(M_g, X)$ and $\mathbf{Hom}_*(C_g, X)$ are motivic flasque. Similarly, the functors $\mathbf{Hom}_*(M_g, \)$ and $\mathbf{Hom}_*(C_g, \)$ preserve pointwise weak equivalences of motivic flasque objects. Both functors preserve filtered colimits, since they are built in finitely many steps from functors that do the same. We have proved statement 5). \square

Remark 2.3. One can show that statement 1) of Lemma 2.2 follows from statement 5), but the presented proof is easier. Statement 1) implies that the Morel-Voevodsky object $T = \mathbb{A}^1/(\mathbb{A}^1 - 0)$ is compact.

2.3 THE STABLE CLOSED MODEL STRUCTURE

Suppose that T is a compact pointed simplicial presheaf on the smooth Nisnevich site $(Sm|_S)_{Nis}$.

The T -loops functor $\Omega_T Y$ is defined for pointed simplicial presheaves Y in terms of internal hom by

$$\Omega_T Y = \mathbf{Hom}_*(T, Y).$$

The T -loops functor is right adjoint to smashing with T , and so the bonding maps $\sigma : T \wedge X^n \rightarrow X^{n+1}$ of a presheaf of T -spectra X can equally well be specified by their adjoints $\sigma_* : X^n \rightarrow \Omega_T X^{n+1}$, up to a twist: σ_* is the adjoint of the composite

$$X^n \wedge T \xrightarrow[\cong]{t} T \wedge X^n \xrightarrow{\sigma} X^{n+1},$$

where t is the isomorphism which flips smash factors.

The T -loops functor $\Omega_T X$ is defined on T -spectra X by setting $(\Omega_T X)^n = \Omega_T(X^n)$, and by specifying that the bonding map $\sigma : T \wedge \Omega_T X^n \rightarrow \Omega_T X^{n+1}$ should be adjoint to the composite

$$T \wedge \Omega_T X^n \wedge T \xrightarrow{T \wedge \text{ev}} T \wedge X^n \xrightarrow{\sigma} X^{n+1}.$$

The T -loops functor $X \mapsto \Omega_T X$ is right adjoint to the functor $Y \mapsto Y \wedge T$ which is defined by smashing with T on the right. More generally, there is a function complex functor $X \mapsto \mathbf{Hom}_*(A, X)$ for all T -spectra X and pointed simplicial presheaves A , and this functor is right adjoint to the functor $X \mapsto X \wedge A$ defined by smashing on the right with A in the obvious way.

Just as in ordinary stable homotopy theory (see [11, Chapter 1]), there is a *fake T -loops spectrum* $\Omega_T^\ell X$, with

$$(\Omega_T^\ell X)^n = \Omega_T(X^n),$$

and with bonding maps adjoint to the morphisms

$$\Omega_T(\sigma_*) : \Omega_T(X^n) \rightarrow \Omega_T^2(X^{n+1}).$$

The fake T -loop suspension functor is right adjoint to the *fake suspension functor* $Y \mapsto \Sigma_T^\ell Y$, where $\Sigma_T^\ell Y^n = T \wedge Y^n$ and the bonding maps $T \wedge \Sigma_T^\ell Y^n \rightarrow \Sigma_T^\ell Y^{n+1}$ are defined to be the morphisms $T \wedge \sigma : T^2 \wedge Y^n \rightarrow T \wedge Y^{n+1}$. Generally, the superscript ℓ for “left”: the functor $X \mapsto \Omega_T^\ell X$ is the right adjoint of $Y \mapsto \Sigma_T^\ell Y$, which is defined by smashing with T on the left.

Remark 2.4. The fake T -loop spectrum $\Omega_T^\ell X$ is *not* isomorphic to the T -loop spectrum $\Omega_T X$, since the adjoint $\sigma_* : \Omega_T X^n \rightarrow \Omega_T^2 X^{n+1}$ of the bonding map $\sigma : T \wedge \Omega_T X^n \rightarrow \Omega_T X^{n+1}$ differs from the map $\Omega_T \sigma_*$ by a twist of loop factors. This phenomenon is the source of much of the technical fun in stable homotopy theory, and the present discussion is no exception — see the proof of Theorem 3.11.

The maps σ_* determine a natural morphism of T -spectra

$$\sigma_* : X \rightarrow \Omega_T^\ell X[1],$$

where the shifted T -spectrum $X[1]$ is defined by $X[1] = X^{n+1}$. The T -spectrum $Q_T X$ is defined to be the inductive colimit of the system

$$X \xrightarrow{\sigma_*} \Omega_T^\ell X[1] \xrightarrow{\Omega_T^\ell \sigma_*[1]} (\Omega_T^\ell)^2 X[2] \xrightarrow{(\Omega_T^\ell)^2 \sigma_*[2]} \dots$$

Write $\eta_X : X \rightarrow Q_T X$ for the associated canonical map. We shall be particularly interested in the composite map

$$X \xrightarrow{j_X} JX \xrightarrow{\eta_{JX}} Q_T JX,$$

which will be denoted by $\tilde{\eta}_X$. The functor Q_T is sometimes called the *stabilization functor*, for the object T .

A map $g : X \rightarrow Y$ of T -spectra is said to be a *stable equivalence* if it induces a level equivalence

$$Q_T J(g) : Q_T JX \rightarrow Q_T JY.$$

Observe that g is a stable equivalence if and only if it induces a level equivalence

$$IQ_T J(g) : IQ_T JX \rightarrow IQ_T JY.$$

More usefully, perhaps, it is a consequence of Corollary 1.7 that g is a stable equivalence if and only if the induced map $Q_T J(g)$ is a pointwise equivalence of motivic flasque simplicial presheaves in all levels.

A *stable fibration* is a map which has the right lifting property with respect to all maps which are cofibrations and stable equivalences. A T -spectrum X is said to be *stably fibrant* if the map $T \rightarrow *$ is a stable fibration.

We shall prove the following statements:

A4 Every level equivalence is a stable equivalence

A5 The maps

$$\tilde{\eta}_{Q_T JX}, Q_T J(\tilde{\eta}_X) : Q_T JX \rightarrow (Q_T J)^2 X$$

are stable equivalences.

A6 Stable equivalences are closed under pullback along stable fibrations, and stable equivalences are closed under pushout along cofibrations.

LEMMA 2.5. *The statements A4 and A5 hold for T -spectra.*

Proof. If $g : X \rightarrow Y$ is a level equivalence between T -spectra such that X and Y are level fibrant, then g is a pointwise weak equivalence of motivic flasque objects in all levels, and so all $\Omega_T^n g$ and $Q_T g$ are level pointwise equivalences by C2 and C3. This proves A4.

The map $Q_T J(j_X) : Q_T JX \rightarrow Q_T J^2 X$ is a level equivalence by A4. There is a commutative diagram

$$\begin{array}{ccc} Q_T J^2 X & \xrightarrow{Q_T J(\eta_{JX})} & Q_T JQ_T JX \\ Q_T(j_{JX}) \uparrow & & \uparrow Q_T(j_{Q_T JX}) \\ Q_T JX & \xrightarrow{Q_T(\eta_{JX})} & Q_T Q_T JX \end{array}$$

The vertical map $Q_T(j_{JX})$ is a level equivalence because j_{JX} is a pointwise weak equivalence of motivic flasque simplicial presheaves in each level, and Q_T preserves such by C2 and C3. All maps $Q_T(\eta_Z)$ are isomorphisms by C1 and a cofinality argument. The map $j_{Q_T JX}$ is a pointwise weak equivalence of motivic flasque simplicial presheaves in each level by Corollary 1.7, and so

the map $Q_T(j_{Q_T JX})$ has the same property by C2 and C3. It follows that $Q_T J(\eta_{JX})$ and $Q_T J(\tilde{\eta}_X)$ are level equivalences.

There is a commutative diagram

$$\begin{array}{ccc}
 JQ_T JX^n & \xrightarrow{\sigma_*} & \Omega_T JQ_T JX^{n+1} \\
 \uparrow j_{Q_T JX} \simeq & & \uparrow \Omega_T(j_{Q_T JX}) \\
 Q_T JX^n & \xrightarrow{\sigma_*} & \Omega_T Q_T JX^{n+1}
 \end{array}$$

The map $j_{Q_T JX}$ is a level pointwise equivalence by Corollary 1.7, the lower map σ_* is an isomorphism by a cofinality argument and C1, and the map $\Omega_T(j_{Q_T JX})$ is a pointwise weak equivalence of motivic flasque simplicial presheaves by C2 and C3. It follows that all maps $\sigma_* : JQ_T JX^n \rightarrow \Omega_T JQ_T JX^{n+1}$ are pointwise weak equivalences, and so the map

$$\eta_{JQ_T JX} : JQ_T JX \rightarrow Q_T JQ_T JX$$

is a level equivalence. In particular, the composite

$$Q_T JX \xrightarrow{j_{Q_T JX}} JQ_T JX \xrightarrow{\eta_{JQ_T JX}} Q_T JQ_T JX$$

is a level equivalence. □

LEMMA 2.6. *The class of stable equivalences is closed under pullback along level fibrations.*

Proof. Suppose given a pullback diagram

$$\begin{array}{ccc}
 A \times_Y X & \xrightarrow{g_*} & X \\
 \downarrow & & \downarrow p \\
 A & \xrightarrow{g} & Y
 \end{array}$$

in which g is a stable equivalence and p is a level fibration. We want to show that g_* is a stable equivalence.

By properness of the level structure and A4, we can assume that all objects are level fibrant. Every level equivalence $C \rightarrow D$ of level fibrant objects consists of pointwise weak equivalences $C^n \rightarrow D^n$ of motivic flasque simplicial presheaves, so Q_T takes each level equivalence of level fibrant objects to a map of T -spectra which consists of pointwise weak equivalences in all levels. All induced maps $Q_T A^n \rightarrow Q_T Y^n$ are pointwise weak equivalences. The maps $p_* : Q_T X^n \rightarrow Q_T Y^n$ are filtered colimits of pointwise Kan fibrations, and are therefore pointwise Kan fibrations. Finally, Q_T preserves pullbacks and the ordinary simplicial set category is proper, so the maps

$$Q_T(g_*) : Q_T(A \times_Y X)^n \rightarrow Q_T X^n$$

are pointwise weak equivalences of simplicial presheaves. □

Every stable fibration is a level fibration, because every level equivalence is a stable equivalence. Lemma 2.6 therefore implies the first statement of A6.

The statements A4 and A5 together imply a Bousfield-Friedlander recognition principle for stable fibrations (see Lemma A.9 of [2]):

LEMMA 2.7. *A map $p : X \rightarrow Y$ is a stable fibration if p is a level fibration and the diagram*

$$\begin{array}{ccc} X & \xrightarrow{\tilde{\eta}_X} & Q_T JX \\ p \downarrow & & \downarrow p_* \\ Y & \xrightarrow{\tilde{\eta}_Y} & Q_T JY \end{array}$$

is level homotopy Cartesian.

In particular, a T -spectrum X is stably fibrant if X is level fibrant and the maps $\sigma_* : X^n \rightarrow \Omega_T X^{n+1}$ are equivalences (or pointwise weak equivalences). We shall need the converse assertion:

LEMMA 2.8. *Suppose that X is stably fibrant. Then X is level fibrant, and all maps $\sigma_* : X^n \rightarrow \Omega_T X^{n+1}$ are pointwise weak equivalences.*

Proof. The composite

$$X \xrightarrow{j_X} JX \xrightarrow{\eta_{JX}} Q_T JX \xrightarrow{i_{Q_T JX}} IQ_T JX$$

is a stable equivalence by Lemma 2.5, and the object $IQ_T JX$ is stably fibrant since all maps

$$\sigma_* : IQ_T JX^n \rightarrow \Omega_T IQ_T JX^{n+1}$$

are pointwise weak equivalences. Write $\mu_X : X \rightarrow IQ_T JX$ for this composite.

Factorize μ_X as

$$\begin{array}{ccc} X & \xrightarrow{\mu_X} & IQ_T JX \\ & \searrow \alpha & \nearrow \pi \\ & Z & \end{array}$$

where π is a level fibration and a level equivalence, and α is a cofibration. Then π is a stable fibration since it has the right lifting property with respect to all cofibrations. It follows that Z is stably fibrant and all maps $\sigma_* : Z^n \rightarrow \Omega_T Z^{n+1}$ are pointwise weak equivalences. Also, the map $\alpha : X \rightarrow Z$ is a cofibration and a stable equivalence. The object X is therefore a retract of Z , and so the maps $\sigma_* : X^n \rightarrow \Omega_T X^{n+1}$ are pointwise weak equivalences. \square

THEOREM 2.9. *Suppose that T is a compact object on the smooth Nisnevich site $(Sm|_S)_{Nis}$. Then the category of T -spectra on that site, together with the classes of cofibrations, stable equivalences and stable fibrations, satisfies the axioms for a proper closed simplicial model category.*

The homotopy category $\text{Ho}(\mathbf{Spt}_T(Sm|_S)_{Nis})$ associated to the stable model structure of Theorem 2.9 is the *motivic stable category* of T -spectra on the smooth Nisnevich site. In the particular case where $T = \mathbb{A}^1/(\mathbb{A}^1 - 0)$, the category $\text{Ho}(\mathbf{Spt}_T(Sm|_S)_{Nis})$ is the motivic stable category of Morel and Voevodsky — it is often denoted by $\mathcal{SH}(S)$.

Proof. The axioms CM1 – CM3 are trivial to verify. We also know (Lemma A.8 of [2], but this is also a direct consequence of Lemma 2.7) that a map p is a stable fibration and a stable equivalence if and only if it is a level fibration and a level equivalence. The existence of the cofibration-trivial fibration factorization of CM5 follows, as does CM4.

It is a consequence of Lemma 2.7 and Lemma 2.8 that a level fibration between stably fibrant objects must be a stable fibration.

To prove the remaining part of CM5, suppose given a map $g : X \rightarrow Y$ of T -spectra. Form the diagram

$$\begin{array}{ccc}
 X & \xrightarrow{\mu_X} & IQ_T JX \\
 \downarrow g & \searrow \alpha_* & \downarrow \alpha \\
 & Y \times_{IQ_T JY} Z & \xrightarrow{\mu_*} Z \\
 & \swarrow p_* & \downarrow g_* \\
 Y & \xrightarrow{\mu_Y} & IQ_T JY \\
 & & \swarrow p
 \end{array}$$

where p is a level fibration and α is a cofibration and a level equivalence. Then Z is level fibrant, and the maps $\alpha : IQ_T JX^n \rightarrow Z^n$ are pointwise equivalences of motivic flasque simplicial presheaves, so Z is stably fibrant. Thus, p is a stable fibration.

The map μ_* is a stable equivalence by Lemma 2.6, so that α_* is a stable equivalence. Factorize α_* as

$$\begin{array}{ccc}
 X & \xrightarrow{\alpha'} & W \\
 \searrow \alpha_* & & \downarrow \pi \\
 & & Y \times_{IQ_T JY} Z
 \end{array}$$

where α' is a cofibration and π is a level fibration and a level equivalence. Then α' is also a stable equivalence, and π is a stable fibration, so $f = (p_*\pi) \cdot \alpha'$ is a factorization of f as a stable fibration following a cofibration which is a stable equivalence, giving CM5.

Part of the properness assertion was proved in Lemma 2.6. For the cofibration statement, form a pushout diagram

$$\begin{array}{ccc} A & \xrightarrow{g} & C \\ j \downarrow & & \downarrow \\ B & \xrightarrow{g_*} & B \cup_A C \end{array}$$

where j is a cofibration and g is a stable equivalence. We must show that g_* is a stable equivalence. By properness of the level structure and by taking a suitable factorization in the level structure, we can assume that g is a cofibration. But then it's a standard fact about closed model categories that trivial cofibrations are closed under pushout.

We must finally verify Quillen's axiom SM7. Suppose that $i : K \rightarrow L$ is a cofibration of pointed simplicial sets and that $\alpha : A \rightarrow B$ is a cofibration of T -spectra. We must show that the cofibration

$$(A \wedge L) \cup_{(A \wedge K)} (B \wedge K) \rightarrow B \wedge L$$

is a stable equivalence if either j is a stable equivalence or i is a weak equivalence of simplicial sets. The case where i is a weak equivalence is a consequence of the corresponding result for the level structure. The remaining case is verified by showing that the cofibration $\alpha \wedge L : A \wedge L \rightarrow B \wedge L$ is a stable equivalence if α is a stable equivalence.

From Lemma 2.8, one sees that if W is both stably fibrant and injective, then so is $\mathbf{hom}_*(L, W)$. Also one can identify the set $[X, W]$ of stable homotopy classes of maps with $\pi_0 \mathbf{hom}(X, W)$ in the sense that the natural map

$$\pi_0 \mathbf{hom}(X, W) \rightarrow [X, W]$$

is a bijection. In effect, there is a trivial level fibration $\pi : X' \rightarrow X$ with X' cofibrant which induces an isomorphism

$$\pi_0 \mathbf{hom}(X, W) \cong \pi_0 \mathbf{hom}(X', W)$$

since W is injective and all T -spectra are cofibrant in the injective model structure (see Remark 2.10 following this proof), while $\pi_0 \mathbf{hom}(X', W) \cong [X', W] \cong [X, W]$ since X' is cofibrant and W is stably fibrant. There is an isomorphism

$$\mathbf{hom}(X, \mathbf{hom}_*(L, W)) \cong \mathbf{hom}(X \wedge L, W),$$

and so there is a natural bijection

$$[X, \mathbf{hom}_*(L, W)] \cong [X \wedge L, W]$$

of morphisms in the stable homotopy category. From Lemma 2.11 below, one sees that a map $g : X \rightarrow Y$ is a stable equivalence if and only if it induces a bijection $g^* : [Y, W] \rightarrow [X, W]$ of morphisms in the homotopy category for all injective stably fibrant objects W . It follows that $\alpha \wedge L$ is a stable equivalence if α is a stable equivalence. \square

Remark 2.10. In general, every map $f : A \rightarrow B$ between cofibrant objects in a closed model category has a factorization

$$\begin{array}{ccc}
 A & \xrightarrow{f} & B \\
 & \searrow j & \nearrow \pi \\
 & C &
 \end{array}$$

where j is a cofibration and π is left inverse to a trivial cofibration — this is really just the standard mapping cylinder construction. It follows that, in a simplicial model category, if W is fibrant and $g : A \rightarrow B$ is a weak equivalence of cofibrant objects, then the induced map

$$g^* : \mathbf{hom}(B, W) \rightarrow \mathbf{hom}(A, W)$$

is a weak equivalence of Kan complexes. This is certainly so if g is a trivial cofibration, and then one uses the above factorization to see the more general case.

LEMMA 2.11. *A map $g : X \rightarrow Y$ is a stable equivalence if and only if it induces bijections*

$$g^* : [Y, W] \xrightarrow{\cong} [X, W]$$

of morphisms in the stable (equivalently, level) homotopy category for all stably fibrant injective objects W .

Proof. Every stable equivalence clearly induces a bijection

$$g^* : [Y, W] \xrightarrow{\cong} [X, W]$$

for all stably fibrant injective objects W .

For the converse, assume that all such maps g^* are bijections. The injective stably fibrant model $X \rightarrow IQ_T JX$ is a stable equivalence, so it suffices to assume that X and Y are both stably fibrant and injective. But then g must be a homotopy equivalence: the homotopy inverse of g is a pre-image under g^* of the class of 1_X for the case $W = X$. \square

With the proof of Theorem 2.9 now completely in hand, Lemma 2.11 can be bootstrapped to the following:

COROLLARY 2.12. *A map $g : X \rightarrow Y$ of T -spectra is a stable equivalence if and only if it induces a weak equivalence*

$$g^* : \mathbf{hom}(Y, W) \rightarrow \mathbf{hom}(X, W)$$

of Kan complexes for all stably fibrant injective objects W .

Proof. If $g : X \rightarrow Y$ is a level equivalence, then the induced map

$$g^* : \mathbf{hom}(Y, W) \rightarrow \mathbf{hom}(X, W)$$

is a weak equivalence for all stably fibrant injective objects W , since all objects in the injective simplicial model structure are cofibrant and we can use Remark 2.10.

Suppose that $g : X \rightarrow Y$ is a stable equivalence. Then there is a diagram

$$\begin{array}{ccc} \tilde{X} & \xrightarrow{\tilde{g}} & \tilde{Y} \\ \pi_X \downarrow & & \downarrow \pi_Y \\ X & \xrightarrow{g} & Y \end{array}$$

such that \tilde{X} and \tilde{Y} are cofibrant and the maps π_X and π_Y are trivial level fibrations. Then, for example, π_X induces a weak equivalence $\pi_X^* : \mathbf{hom}(X, W) \rightarrow \mathbf{hom}(\tilde{X}, W)$ for all stably fibrant injective objects W by the previous paragraph. It suffices, therefore, to assume that X and Y are cofibrant, but then Remark 2.10 can be used in the stable simplicial model structure to show that g^* is a weak equivalence of simplicial sets.

For the reverse direction, suppose that $g^* : \mathbf{hom}(Y, W) \rightarrow \mathbf{hom}(X, W)$ is a weak equivalence for all stably fibrant injective W . Then by computing in π_0 , the induced map

$$g^* : [Y, W] \rightarrow [X, W]$$

of morphisms in the homotopy category is a bijection for all stably fibrant injective W , and Lemma 2.11 can be applied. \square

2.4 CHANGE OF SUSPENSION

Any map $\theta : T_1 \rightarrow T_2$ of pointed simplicial presheaves on the site $(Sm|_S)_{Nis}$ induces a functor

$$\theta^* : \mathbf{Spt}_{T_2}(Sm|_S)_{Nis} \rightarrow \mathbf{Spt}_{T_1}(Sm|_S)_{Nis},$$

by precomposing the bonding maps with θ . More precisely, for any T_2 -spectrum X , θ^*X is the T_1 -spectrum with $(\theta^*X)^n = X^n$, with bonding maps given by the composites

$$T_1 \wedge X^n \xrightarrow{\theta \wedge 1} T_2 \wedge X^n \xrightarrow{\sigma} X^{n+1}.$$

There is homotopical content to this construction when T_1 and T_2 are compact and θ is an equivalence:

PROPOSITION 2.13. *Suppose that $\theta : T_1 \rightarrow T_2$ is a weak equivalence of compact objects on the site $(Sm|_S)_{Nis}$. Then the functor θ^* induces an equivalence of motivic stable homotopy categories*

$$\theta^* : \text{Ho}(\mathbf{Spt}_{T_2}(Sm|_S)_{Nis}) \rightarrow \text{Ho}(\mathbf{Spt}_{T_1}(Sm|_S)_{Nis}).$$

Proof. Write σ_θ for the bonding maps of $\theta^* X$. The functor θ^* clearly preserves level equivalences, level fibrations and level cofibrations. If X is level fibrant, there is a diagram

$$\begin{array}{ccccccc}
 X^n & \xrightarrow{\sigma} & \Omega_{T_2} X^{n+1} & \xrightarrow{\Omega_{T_2} \sigma} & \Omega_{T_2}^2 X^{n+2} & & \dots \\
 & \searrow \sigma_\theta & \downarrow \theta^* & & \downarrow \theta^* & & \\
 & & \Omega_{T_1} X^{n+1} & \xrightarrow{\Omega_{T_1} \sigma} & \Omega_{T_1} \Omega_{T_2} X^{n+2} & & \dots \\
 & & & \searrow \Omega_{T_1} \sigma_\theta & \downarrow \Omega_{T_1} \theta^* & & \\
 & & & & \Omega_{T_1}^2 X^{n+2} & & \dots
 \end{array}$$

All vertical maps are pointwise weak equivalences, so there are induced natural pointwise weak equivalences $\theta^* : Q_{T_2} X^n \rightarrow Q_{T_1} \theta^* X^n$ for level fibrant objects X . It follows that $g : X \rightarrow Y$ is a stable equivalence of T_2 -spectra if and only if $\theta^* g : \theta^* X \rightarrow \theta^* Y$ is a stable equivalence of presheaves of T_1 -spectra. In particular, θ^* induces a functor

$$\theta^* : \text{Ho}(\mathbf{Spt}_{T_2}(Sm|_S)_{Nis}) \rightarrow \text{Ho}(\mathbf{Spt}_{T_1}(Sm|_S)_{Nis}).$$

on stable homotopy categories. It also follows, using Lemma 2.7, that θ^* preserves stable fibrations.

To go further, we must presume that θ is a cofibration as well as an equivalence. This suffices, since the factorization trick of Remark 2.10 involves the mapping cylinder, and we have Lemma 2.2.

Given this new assumption, one can further show that θ^* preserves cofibrations: given a cofibration $i : A \rightarrow B$ of T_2 -spectra, there is a pushout diagram

$$\begin{array}{ccc}
 (T_1 \wedge B^n) \cup_{(T_1 \wedge A^n)} (T_2 \wedge B^n) & \longrightarrow & (T_1 \wedge B^n) \cup_{(T_1 \wedge A^n)} A^{n+1} \\
 (\theta, i)_* \downarrow & & \downarrow \theta_* \\
 T_2 \wedge B^n & \longrightarrow & (T_2 \wedge B^n) \cup_{(T_2 \wedge A^n)} A^{n+1}
 \end{array}$$

in which $(\theta, i)_*$ is a cofibration. The canonical map

$$(T_1 \wedge B^n) \cup_{(T_1 \wedge A^n)} A^{n+1} \rightarrow B^{n+1}$$

for $\theta^* i$ is the composite

$$(T_1 \wedge B^n) \cup_{(T_1 \wedge A^n)} A^{n+1} \xrightarrow{\theta_*} (T_2 \wedge B^n) \cup_{(T_2 \wedge A^n)} A^{n+1} \rightarrow B^{n+1},$$

so θ^*i is a cofibration of T_1 -spectra if i is a cofibration of T_2 -spectra.

Every stably fibrant T_1 -spectrum X is of the form $X = \theta^*\overline{X}$ for some stably fibrant T_2 -spectrum \overline{X} . To see this, let $\overline{X}^n = X^n$, and choose bonding maps $\overline{\sigma} : T_2 \wedge X^n \rightarrow X^{n+1}$ making the following diagram commute:

$$\begin{array}{ccc} T_1 \wedge X^n & \xrightarrow{\sigma} & X^{n+1} \\ \theta \wedge 1 \downarrow & \nearrow \overline{\sigma} & \\ T_2 \wedge X^n & & \end{array}$$

One gets away with this because $\theta \wedge 1$ is a trivial cofibration. It follows that every stably fibrant T_1 -spectrum X is stably equivalent to a T_1 -spectrum θ^*Y , where Y is a stably fibrant and cofibrant T_2 -spectrum.

To finish off the proof, the idea is to show that $\theta : T_1 \rightarrow T_2$ induces a weak equivalence of Kan complexes

$$\mathbf{hom}(A, X) \xrightarrow{\theta^*} \mathbf{hom}(\theta^*A, \theta^*X)$$

for all cofibrant A and stably fibrant X . Computing in π_0 implies that θ induces bijections

$$\theta^* : [Y, X] \xrightarrow{\cong} [\theta^*Y, \theta^*X]$$

for all stably fibrant, cofibrant objects X and Y . The desired result then follows from basic category theory.

We show that θ^* is a weak equivalence of Kan complexes by showing that, given any solid arrow diagram

$$\begin{array}{ccc} \partial\Delta^n & \longrightarrow & \mathbf{hom}(A, X) \\ \downarrow & \nearrow \text{dotted} & \downarrow \\ \Delta^n & \longrightarrow & \mathbf{hom}(\theta^*A, \theta^*X) \end{array}$$

a dotted arrow exists such that

- 1) the upper triangle commutes, and
- 2) the lower triangle commutes up to homotopy which is constant on $\partial\Delta^n$.

This homotopy lifting property is implied by the following: given any solid arrow commutative diagrams

$$\begin{array}{ccc} A & \xrightarrow{\alpha} & X \\ j \downarrow & \nearrow g & \\ B & & \end{array} \qquad \begin{array}{ccc} \theta^*A & \xrightarrow{\theta^*\alpha} & \theta^*X \\ \theta^*j \downarrow & \nearrow f & \\ \theta^*B & & \end{array}$$

with A is cofibrant, j is a cofibration and X is stably fibrant, then the dotted arrow g exists making the diagram of T_2 -spectra commute, and there is a homotopy $\theta^*g \simeq f$ which is constant at $\theta^*\alpha$ on θ^*A .

This last property is proved by a homotopy extension argument which depends on the assumption that θ is a trivial cofibration. The method is to inductively find the dotted arrows h and g making the following diagrams simultaneously commute

$$\begin{array}{ccc}
 B^{n+1} & & T_1 \wedge B^n \times \Delta^1 \xrightarrow{T_1 \wedge h} T_1 \wedge X^n \\
 d^1 \downarrow & \searrow f & \theta \wedge 1 \downarrow \\
 B^{n+1} \times \Delta^1 & \xrightarrow{h} & X^{n+1} & T_2 \wedge B^n \times \Delta^1 & \xrightarrow{\theta \wedge 1} & T_2 \wedge X^n \\
 d^0 \uparrow & \nearrow g & & \sigma \times \Delta^1 \downarrow & & \sigma \downarrow \\
 B^{n+1} & & & B^{n+1} \times \Delta^1 & \xrightarrow{h} & X^{n+1}
 \end{array}$$

$$\begin{array}{ccc}
 A^{n+1} \times \Delta^1 & \xrightarrow{pr} & A^{n+1} & T_2 \wedge B^n & \xrightarrow{T_2 \wedge g} & T_2 \wedge X^n \\
 j \times \Delta^1 \downarrow & & \downarrow \alpha & \sigma \downarrow & & \downarrow \sigma \\
 B^{n+1} \times \Delta^1 & \xrightarrow{h} & X^{n+1} & B^{n+1} & \xrightarrow{g} & X^{n+1}
 \end{array}$$

The inclusion of

$$(A^{n+1} \cup (T_1 \wedge B^n)) \times \Delta^1 \cup (A^{n+1} \cup (T_2 \wedge B^n)) \times \partial \Delta^1$$

in $(A^{n+1} \cup (T_2 \wedge B^n)) \times \Delta^1$ is a trivial cofibration since θ is trivial, so that the composite homotopy

$$T_1 \wedge B^n \times \Delta^1 \xrightarrow{T_1 \wedge h} T_1 \wedge X^n \xrightarrow{\theta \wedge 1} T_2 \wedge X^n \xrightarrow{\sigma} X^{n+1}$$

extends to a homotopy $\tilde{h} : T_2 \wedge B^n \times \Delta^1 \rightarrow X^{n+1}$ from $f \cdot \sigma$ to $\sigma \cdot (T_2 \wedge g)$ which is constant on A^{n+1} . The homotopy \tilde{h} extends to the desired map h in the usual way, since the map

$$(A^{n+1} \cup (T_2 \wedge B^n)) \times \Delta^1 \cup B^{n+1} \times \{0\} \rightarrow B^{n+1} \times \Delta^1$$

is a trivial cofibration. □

2.5 BOUNDED COFIBRATIONS

The commutativity of the diagram (1.2) for the controlled fibrant model construction $X \mapsto \mathcal{L}X$ of Section 1 implies that this construction can be promoted to the category of T -spectra. More explicitly, there is a natural level fibrant

model $\eta_X : X \rightarrow \mathcal{L}X$ defined for T -spectra such that the map η_X is a level cofibration and a level equivalence. The standard properties of the functor \mathcal{L} (see Section 1.1) pass to the spectrum level, and so the functor \mathcal{L} is an example of a functor $F : \mathbf{Spt}_T(Sm|_S)_{Nis} \rightarrow \mathbf{Spt}_T(Sm|_S)_{Nis}$ which satisfies the following:

L1: F preserves level weak equivalences.

L2: F preserves level cofibrations.

L3: Let β be any cardinal with $\beta \geq \alpha$. Let $\{X_j\}$ be the filtered system of sub-objects of X which are β -bounded. Then the map

$$\varinjlim F(X_j) \rightarrow FX$$

is an isomorphism.

L4: Let γ be an ordinal number of cardinality strictly greater than 2^α . Let $X : \gamma \rightarrow \mathbf{Spt}_T(Sm|_S)_{Nis}$ be a diagram of level cofibrations so that for all limit ordinals $s < \gamma$ the induced map

$$\varinjlim_{t < s} X(t) \rightarrow X(s)$$

is an isomorphism. Then $\varinjlim_{t < \gamma} F(X(t)) \cong F(\varinjlim_{t < \gamma} X(t))$.

L5: If X is λ -bounded, then FX is λ -bounded.

L6: Let Y, Z be two subobjects of X . Then

$$FY \cap FZ = F(Y \cap Z)$$

in FX .

L7: The functor F is continuous; that is, it extends to a natural morphism of simplicial sets

$$F : \mathbf{hom}(X, Y) \rightarrow \mathbf{hom}(FX, FY)$$

compatible with composition.

Recall that the cardinals λ and κ are chosen such that

$$\lambda = 2^\kappa > \kappa > 2^\alpha,$$

where α is an upper bound on the cardinality of the set of morphisms of (the chosen approximation for) the smooth Nisnevich site.

Remark 2.14. If the spectrum X has extra structure, such as a symmetric structure, then that structure is preserved by the functor $X \mapsto \mathcal{L}X$: the pairings

$$\mathcal{L}X^n \wedge L \xrightarrow{\phi} \mathcal{L}(X^n \wedge L)$$

satisfy properties L9 and L10 in Section 1.1, and are natural in L and X^n so that they respect all symmetric group actions.

Say that a map $g : X \rightarrow Y$ of T -spectra is an F -equivalence if it induces a level weak equivalence $Fg : FX \rightarrow FY$.

PROPOSITION 2.15. *Suppose that the functor*

$$F : \mathbf{Spt}_T(\mathit{Sm}|_S)_{Nis} \rightarrow \mathbf{Spt}_T(\mathit{Sm}|_S)_{Nis}$$

satisfies the conditions L1 – L7. Then the class of cofibrations of T -spectra which are F -equivalences satisfies the bounded cofibration condition for the cardinal λ .

Proof. The class of maps of T -spectra which are level cofibrations and level equivalences satisfies the bounded cofibration condition for the cardinal λ . To see this, recall that the category of simplicial presheaves satisfies the bounded cofibration condition with respect to the cardinal λ , since λ is an upper bound for the cardinality of the set of morphisms of the underlying site [4, Lemma 2.3]. Then use the argument for the second part of Lemma 2.1.

Suppose that $i : X \hookrightarrow Y$ is a cofibration in the category of T -spectra, and that $j : A \hookrightarrow Y$ is a subobject of Y . Then the restriction $X \cap A \rightarrow A$ is a cofibration of T -spectra (so that the statement of the Proposition makes sense). The claim for S^1 -spectra was proved in Lemma 3.1 of [4]. There is nothing special about the simplicial circle S^1 in that argument, so the same argument obtains here.

Alternatively, the key is to show that the map

$$j_* : (T \wedge A^n) \cup_{(T \wedge (A^n \cap X^n))} (A^{n+1} \cap X^{n+1}) \rightarrow (T \wedge Y^n) \cup_{(T \wedge X^n)} X^{n+1}$$

is an inclusion in all presheaves of simplices for all n . But

$$\begin{aligned} & (T \wedge A^n) \cup_{(T \wedge (A^n \cap X^n))} (A^{n+1} \cap X^{n+1}) \\ &= ((T - *) \times (A^n - X^n)) \sqcup (A^{n+1} \cap X^{n+1}), \end{aligned}$$

at the simplex level, while

$$(T \wedge Y^n) \cup_{(T \wedge X^n)} X^{n+1} = ((T - *) \times (Y^n - X^n)) \sqcup X^{n+1},$$

and the map between the two is obvious.

Let $X \rightarrow Y$ be an F -equivalence and a cofibration of T -spectra, and let $A \subseteq Y$ be a λ -bounded sub-object. Inductively define a chain of λ -bounded sub-objects $A = A_0 \subseteq A_1 \subseteq A_2 \subseteq \dots \subseteq Y$ over λ , and a chain of sub-objects

$$F(A) = F(A_0) \subseteq X_1 \subseteq F(A_1) \subseteq X_2 \subseteq F(A_2) \subseteq \dots \subseteq F(Y),$$

also over λ , with the property that the cofibration

$$F(X) \cap X_s \rightarrow X_s$$

is a level weak equivalence. Set $B = \varinjlim_{s < \kappa} A_s$. Then, by L6,

$$\begin{aligned} F(X \cap B) &= F(X) \cap F(B) = \varinjlim_{s < \kappa} F(X) \cap X_s \\ &\rightarrow \varinjlim_{s < \kappa} X_s \cong F(B) \end{aligned}$$

is a level weak equivalence, and so $X \cap B \hookrightarrow B$ is an F -equivalence.

The A_s and X_s are defined recursively. Suppose $s + 1$ is a successor ordinal and A_s has been defined. Then, since A_s is λ -bounded, $F(A_s)$ is λ -bounded by L5. The map $F(X) \rightarrow F(Y)$ is a cofibration and a level equivalence, so there is a λ -bounded sub-object $X_{s+1} \subseteq F(Y)$ so that $F(A_s) \subseteq X_{s+1}$ and $F(X) \cap X_{s+1} \rightarrow X_{s+1}$ is a level weak equivalence. Since there is a filtered colimit $F(Y) = \varinjlim F(Y_j)$ indexed over the λ -bounded subobjects Y_j by L3, there is a λ -bounded subobject A'_{s+1} of Y so that $X_{s+1} \subset F(A'_{s+1})$. Set $A_{s+1} = A_s \cup A'_{s+1}$. Finally suppose that s is a limit ordinal, and set

$$X_s = \varinjlim_{t < s} F(A_t) \cong \varinjlim_{t < s} X_t.$$

Then X_s is λ -bounded and $F(X) \cap X_s \rightarrow X_s$ is a level weak equivalence. Choose $A'_s \subset Y$ such that A'_s is λ -bounded and $X_s \subset F(A'_s)$. Set $A_s = \varinjlim_{t < s} A_t \cup A'_s$. \square

COROLLARY 2.16. *The class of cofibrations which are stable equivalences satisfies the bounded cofibration condition with respect to the cardinal λ .*

Proof. The functor $X \mapsto Q_T \mathcal{L}X$ is an example of a functor F satisfying the conditions for Proposition 2.15. \square

3 FIBRE AND COFIBRE SEQUENCES

The purpose of this section is to show that the standard calculus of fibre and cofibre sequences can be promoted to the motivic stable category, with the help of a suitable theory of stable homotopy groups with weights. The outcomes include detection of motivic stable equivalences by presheaves of weighted stable homotopy groups, and a collection of results which together assert that fibre and cofibre sequences are indistinguishable in the motivic stable category.

The last part of this section is devoted to showing that the various standard flavors of suspension functors (ie. left, right, and shift) are equivalent. These results turn out to be special, and depend on knowing Voevodsky's observation that the cyclic permutation of order 3 acts trivially on $T^3 = T^{\wedge 3}$ in the motivic homotopy category. The Voevodsky result appears here as Lemma 3.13.

3.1 EXACT SEQUENCES FOR S^1 -SPECTRA

Recall that Lemma 2.2 asserts, in part, that finite pointed simplicial sets are compact. The simplicial circle S^1 is finite, so that Theorem 2.9 implies that there is a proper closed simplicial model structure on the category

$$\mathbf{Spt}(Sm|_S)_{Nis} = \mathbf{Spt}_{S^1}(Sm|_S)_{Nis}$$

for S^1 -spectra on the smooth Nisnevich site, for which the weak equivalences are the motivic stable equivalences. Our first job is to show that the traditional facts about fibre and cofibre sequences of ordinary spectra have analogues in this setting.

LEMMA 3.1. *Suppose that a map $g : X \rightarrow Y$ of S^1 -spectra is an ordinary local stable equivalence. Then g is a motivic stable equivalence.*

Recall [10], [11] that a map $g : X \rightarrow Y$ of presheaves of spectra is a *local stable equivalence* if it induces an isomorphism on all sheaves of ordinary stable homotopy groups.

Proof. If an S^1 -spectrum W is motivic injective and motivic stably fibrant, it must be injective and stably fibrant for the local theory. It follows that ordinary stable homotopy classes $[X, W]$ coincide with naive homotopy classes $\pi(X, W)$ and hence with level homotopy classes $[X, W]$ in the motivic theory for all such W and all S^1 -spectra X . Thus, every stable equivalence $g : X \rightarrow Y$ induces a bijection

$$g^* : [Y, W] \rightarrow [X, W]$$

in level homotopy classes for the motivic theory if W is motivic injective and motivic stably fibrant. Lemma 2.11 implies that g is a motivic stable equivalence. \square

COROLLARY 3.2. *Suppose that*

$$F \xrightarrow{i} X \xrightarrow{p} Y$$

is a level motivic fibre sequence of S^1 -spectra. Then the induced map $p_ : X/F \rightarrow Y$ is a motivic stable equivalence.*

Proof. This is a consequence of the corresponding result for ordinary spectra, and Lemma 3.1. \square

All weak equivalences, stable equivalences, fibrations and so on will be tacitly assumed to be motivic henceforth. We shall drop the use of the term “motivic”, except when it is necessary to include it for clarity.

LEMMA 3.3. *Suppose given a commutative diagram of S^1 -spectra*

$$\begin{array}{ccccc} A_1 & \longrightarrow & B_1 & \longrightarrow & C_1 \\ f_1 \downarrow & & \downarrow f_2 & & \downarrow f_3 \\ A_2 & \longrightarrow & B_2 & \longrightarrow & C_2 \end{array}$$

in which the horizontal sequences are level cofibre sequences. Then if any two of f_1, f_2 or f_3 are stable equivalences, then so is the third.

Proof. We will show that f_1 is a stable equivalence if f_2 and f_3 are stable equivalences. The other two cases are similar.

The idea is to show that precomposition with f_1 induces a weak equivalence

$$f_1^* : \mathbf{hom}(A_2, W) \rightarrow \mathbf{hom}(A_1, W)$$

of function complexes for any stably fibrant injective object W . The map of cofibre sequences induces a comparison diagram of fibre sequences

$$\begin{array}{ccccc} \mathbf{hom}(C_2, W) & \longrightarrow & \mathbf{hom}(B_2, W) & \longrightarrow & \mathbf{hom}(A_2, W) \\ f_3^* \downarrow & & \downarrow f_2^* & & \downarrow f_1^* \\ \mathbf{hom}(C_1, W) & \longrightarrow & \mathbf{hom}(B_1, W) & \longrightarrow & \mathbf{hom}(A_1, W) \end{array}$$

The level equivalences $W \rightarrow \Omega W[1]$ of stably fibrant injective objects give all spaces in this diagram the structure of infinite loop spaces, and f_2^* and f_3^* are the maps at level 0 for stable equivalences of spectra. The map f_1^* is therefore the level 0 part of a stable equivalence of stably fibrant spectra, and so f_1^* is a weak equivalence of simplicial sets. \square

We now have the following consequence of Corollary 3.2 and Lemma 3.3:

COROLLARY 3.4. *Suppose given a commutative diagram of S^1 -spectra*

$$\begin{array}{ccccc} F_1 & \longrightarrow & X_1 & \longrightarrow & Y_1 \\ f_1 \downarrow & & \downarrow f_2 & & \downarrow f_3 \\ F_2 & \longrightarrow & X_2 & \longrightarrow & Y_2 \end{array}$$

in which the horizontal sequences are level fibre sequences. Then if any two of f_1, f_2 or f_3 are stable equivalences, then so is the third.

Recall that a map $g : X \rightarrow Y$ is a stable equivalence of S^1 -spectra if and only if it induces a pointwise level equivalence $g_* : QJX \rightarrow QJY$. The functor $QJ = Q_{S^1}J$ produces presheaves of infinite loop spaces, so that g_* is a pointwise level equivalence if and only if it induces pointwise isomorphisms

$$\pi_n QJX(U) \cong \pi_n QJY(U)$$

in all homotopy groups. The group $\pi_n QJX(U)$ can be identified up to isomorphism with the filtered colimit of the system

$$[S^{n+r}, X^r|_U] \rightarrow [S^{n+r+1}, X^{r+1}|_U] \rightarrow \dots,$$

where S^t denotes the t -fold smash product of the constant simplicial presheaf associated to the simplicial circle S^1 , and the morphisms in the motivic homotopy category are computed over the scheme U . This filtered colimit may be

computed without reference to a level fibrant model for X ; we define a presheaf $\pi_n X$ of *stable homotopy groups* for X in U -sections to be the filtered colimit of this system. A map $g : X \rightarrow Y$ is a motivic stable equivalence if and only if it induces presheaf isomorphisms $\pi_n X \cong \pi_n Y$ for all $n \in \mathbb{Z}$.

WARNING: The presheaves of groups $\pi_n X$ are defined by morphisms in the motivic homotopy category. Despite the notation, they do not coincide with the stable homotopy group presheaves of X , but rather with the stable homotopy group presheaves of a motivic stably fibrant model for X .

Any level fibre sequence

$$F \xrightarrow{i} X \xrightarrow{p} Y$$

can be functorially replaced up to level equivalence by a fibre sequence in which all objects are level fibrant. Suppose that this has been done — then the induced maps of S^1 -spectra

$$QF \xrightarrow{Q_i} QX \xrightarrow{Q_p} QY$$

forms a level fibre sequence of spectra

$$QF(U) \xrightarrow{Q_i} QX(U) \xrightarrow{Q_p} QY(U)$$

in each section, and therefore determines a long exact sequence

$$\dots \xrightarrow{p_*} \pi_{n+1} QY(U) \xrightarrow{\partial} \pi_n QF(U) \xrightarrow{i_*} \pi_n QX(U) \xrightarrow{p_*} \pi_n QY(U) \xrightarrow{\partial} \dots$$

of presheaves of stable homotopy groups. It follows that there is a natural long exact sequence

$$\dots \xrightarrow{p_*} \pi_{n+1} Y \xrightarrow{\partial} \pi_n F \xrightarrow{i_*} \pi_n X \xrightarrow{i_*} \pi_n Y \xrightarrow{\partial} \dots$$

of presheaves of groups associated to a level fibre sequence.

Suppose given a level cofibre sequence

$$A \xrightarrow{i} B \xrightarrow{\pi} B/A, \tag{3.1}$$

and replace the map π up to motivic weak equivalence by a level motivic fibration by taking a factorization

$$\begin{array}{ccc} B & \xrightarrow{\pi} & B/A \\ j \downarrow & \nearrow q & \\ X & & \end{array}$$

where q is a level motivic fibration and j is a cofibration and a level motivic equivalence. Let F be the fibre of q . Then the cofibre sequence (3.1) is a fibre sequence in the standard way in the motivic setting, in the sense that we can prove

LEMMA 3.5. *The cofibration j induces a motivic stable equivalence $j_* : A \rightarrow F$.*

Proof. There is a commutative diagram

$$\begin{array}{ccccc}
 A & \xrightarrow{i} & B & \xrightarrow{\pi} & B/A \\
 \downarrow j & & \downarrow j & & \downarrow j_* \\
 F & \longrightarrow & X & \xrightarrow{\pi} & X/F
 \end{array}$$

The map $q : X \rightarrow B/A$ factors through $\pi : X \rightarrow X/F$ in that there is a map $q_* : X/F \rightarrow B/A$ such that $q_* \cdot \pi = q$. The map q_* is a stable equivalence by Corollary 3.2. One also checks that $q_* j_* \pi = \pi$ so that $q_* j_* = 1$ on B/A , and so j_* is a stable equivalence. Now use Lemma 3.3 to conclude that the induced map $j : A \rightarrow F$ of S^1 -spectra is a stable equivalence. \square

COROLLARY 3.6. *Any cofibre sequence*

$$A \xrightarrow{i} B \xrightarrow{\pi} B/A$$

induces a natural long exact sequence

$$\dots \xrightarrow{\pi_*} \pi_{i+1} B/A \xrightarrow{\partial} \pi_i A \xrightarrow{i_*} \pi_i B \xrightarrow{\pi_*} \pi_i B/A \xrightarrow{\partial} \dots$$

Proof. The sequence is the long exact sequence for the corresponding fibre sequence arising from the construction of Lemma 3.5. \square

3.2 WEIGHTED STABLE HOMOTOPY GROUPS

The presheaf $T = \mathbb{A}^1/(\mathbb{A}^1 - 0)$ sits in a pushout square of presheaves

$$\begin{array}{ccc}
 \mathbb{A}^1 - 0 & \xrightarrow{i} & \mathbb{A}^1 \\
 \downarrow & & \downarrow \\
 * & \longrightarrow & T,
 \end{array}$$

and \mathbb{A}^1 is contractible in the motivic homotopy category. A standard argument on mapping cones (which uses properness) implies that there are motivic equivalences

$$T = \mathbb{A}^1/(\mathbb{A}^1 - 0) \xleftarrow{\simeq} M_i/(\mathbb{A}^1 - 0) \xrightarrow{\simeq} S^1 \wedge (\mathbb{A}^1 - 0)$$

involving the mapping cylinder M_i of the inclusion i . All of these objects are compact, by Lemma 2.2, and Proposition 2.13 implies that the displayed

equivalences induces equivalences of the stable categories associated to the various suspensions.

For convenience, write $\mathbb{G}_m = \mathbb{A}^1 - 0$, pointed by the global section given by the identity element e (Voevodsky denotes this object by S^1_ℓ [16]). This is the underlying scheme of the multiplicative group, but the group structure is never used.

Recall that a map $g : X \rightarrow Y$ of spectra is an stable equivalence if and only if the induced map $g_* : Q_T JX \rightarrow Q_T JY$ is a pointwise level equivalence. Recall further that the object $Q_T Y$ for a level fibrant spectrum Y has object at level n given by the filtered colimit

$$Y^n \xrightarrow{\sigma_*} \Omega_T Y^{n+1} \xrightarrow{\Omega_T \sigma_*} \Omega_T^2 Y^{n+2} \rightarrow \dots$$

The homotopy group $\pi_r Q_T Y^n(U)$ in U -sections is isomorphic to the filtered colimit of the diagram

$$\pi_r Y^n(U) \xrightarrow{\sigma_*} \pi_r \Omega_T Y^{n+1}(U) \xrightarrow{\Omega_T \sigma_*} \pi_r \Omega_T^2 Y^{n+2}(U) \rightarrow \dots,$$

which can be identified with a filtered colimit of maps in the motivic homotopy category over the scheme U of the form

$$[S^r, Y^n|_U] \rightarrow [S^r \wedge T, Y^{n+1}|_U] \rightarrow [S^r \wedge T^2, Y^{n+2}|_U] \rightarrow \dots$$

Here, T^r denotes an r -fold wedge product of copies of the simplicial presheaf T , and S^r is the r -fold wedge product of copies of S^1 . The equivalence $T \simeq S^1 \wedge \mathbb{G}_m$ further implies that this last inductive system can be rewritten as

$$[S^r, Y^n|_U] \rightarrow [S^{r+1} \wedge \mathbb{G}_m, Y^{n+1}|_U] \rightarrow [S^{r+2} \wedge \mathbb{G}_m^2, Y^{n+2}|_U] \rightarrow \dots$$

Write $\pi_{t,s} Y(U)$ for the colimit of the sequence

$$[S^{t+n} \wedge \mathbb{G}_m^{s+n}, Y^n|_U] \rightarrow [S^{t+n+1} \wedge \mathbb{G}_m^{s+n+1}, Y^{n+1}|_U] \rightarrow \dots$$

The variable t in $\pi_{t,s} Y$ is usually called the *degree*, while s is called the *weight*. The presheaves of groups $\pi_{t,s} Y$ are called the *weighted stable homotopy groups* of the T -spectrum Y .

This last definition of the presheaf $U \mapsto \pi_{t,s} Y(U)$ makes sense for any T -spectrum Y , and there is an isomorphism

$$\pi_r Q_T JY^n(U) \cong \pi_{r-n, -n} Y(U).$$

From a different point of view, if $t \leq s$, then there are isomorphisms

$$\begin{aligned} \varinjlim_n [S^{t+n} \wedge \mathbb{G}_m^{s+n}, Y^n|_U] &\cong \varinjlim_n [S^n \wedge \mathbb{G}_m^{s-t+n}, Y[-t]^n|_U] \\ &\cong \varinjlim_n [S^n \wedge \mathbb{G}_m^n, \Omega_{\mathbb{G}_m}^{s-t} JY[-t]^n|_U], \end{aligned}$$

where $Y[k]^n = Y^{n+k}$ defines the shifted T -spectrum object $Y[k]$ in the standard way for all $k \in \mathbb{Z}$. It follows that there is an isomorphism

$$\pi_{t,s}Y \cong \pi_0 \Omega_{\mathbb{G}_m}^{s-t} Q_T(JY[-t])^0$$

if $t \geq s$. Similarly, if $s \geq t$, there is an isomorphism

$$\pi_{t,s}Y \cong \pi_0 \Omega^{t-s} Q_T(JY[-s])^0.$$

If $g : X \rightarrow Y$ is a stable equivalence, then $g_* : Q_T(JX[k]) \rightarrow Q_T(JY[k])$ is a pointwise level equivalence for all $k \in \mathbb{Z}$, so that all induced maps

$$g_* : \pi_{t,s}X \rightarrow \pi_{t,s}Y$$

are isomorphisms of presheaves. Conversely, if g induces isomorphisms in all bigraded stable homotopy group presheaves, then g induces isomorphisms $\pi_{t,s}X \cong \pi_{t,s}Y$ for $s \leq 0$ and $t \geq s$. In that case

$$\pi_{t,s}Y = \pi_{(t-s)+s,s}Y \cong \pi_{t-s} Q_T Y^{-s},$$

so that $g_* : Q_T JX \rightarrow Q_T JY$ is a pointwise level equivalence. We have proved

LEMMA 3.7. *A map $g : X \rightarrow Y$ of T -spectra is a stable equivalence if and only if g induces isomorphisms*

$$\pi_{t,s}X \cong \pi_{t,s}Y$$

of presheaves of groups for all $t, s \in \mathbb{Z}$.

Given Proposition 2.13, we can assume that T is identically $S^1 \wedge \mathbb{G}_m$, so a T -spectrum consists of pointed simplicial presheaves Y^n and bonding maps

$$S^1 \wedge \mathbb{G}_m \wedge Y^n \rightarrow Y^{n+1}.$$

An S^1/\mathbb{G}_m -bispectrum consists of pointed simplicial presheaves $X^{m,n}$, $m, n \geq 0$, together with bonding maps $\sigma_h : S^1 \wedge X^{m,n} \rightarrow X^{m+1,n}$ and $\sigma_v : \mathbb{G}_m \wedge X^{m,n} \rightarrow X^{m,n+1}$, such that the diagram

$$\begin{array}{ccc}
 S^1 \wedge X^{m,n+1} & \xrightarrow{\sigma_h} & X^{m+1,n+1} \\
 S^1 \wedge \sigma_v \uparrow & & \uparrow \sigma_v \\
 S^1 \wedge \mathbb{G}_m \wedge X^{m,n} & \xrightarrow{\cong} & \mathbb{G}_m \wedge S^1 \wedge X^{m,n} \xrightarrow{\mathbb{G}_m \wedge \sigma_h} \mathbb{G}_m \wedge X^{m+1,n} \\
 & \searrow t \wedge 1 & \\
 & &
 \end{array}$$

commutes, where $t : S^1 \wedge \mathbb{G}_m \rightarrow \mathbb{G}_m \wedge S^1$ is the canonical isomorphism which flips smash factors. The maps σ_v and σ_h are called *vertical* and *horizontal*

bonding maps respectively. Such a gadget may alternatively be viewed as a collection of S^1 -spectra

$$X^n = X^{*,n},$$

together with maps of S^1 -spectra $X^n \wedge \mathbb{G}_m \rightarrow X^{n+1}$ induced by the vertical bonding maps.

For us, the key example arises from a T -spectrum Y , in that it functorially determines an array $Y^{*,*}$

$$\begin{array}{cccc}
 \vdots & \vdots & \vdots & \\
 \mathbb{G}_m^{\wedge 2} \wedge Y^0 & \mathbb{G}_m \wedge Y^1 & Y^2 & \dots \\
 \mathbb{G}_m \wedge Y^0 & Y^1 & S^1 \wedge Y^1 & \dots \\
 Y^0 & S^1 \wedge Y^0 & S^2 \wedge Y^0 & \dots
 \end{array}$$

which has the structure of an S^1/\mathbb{G}_m -bispectrum. In effect, the horizontal bonding map $\sigma_h : S^1 \wedge \mathbb{G}_m^k \wedge Y^n \rightarrow \mathbb{G}_m^{k-1} \wedge Y^{n+1}$ is defined to be the composite

$$S^1 \wedge \mathbb{G}_m^{k-1} \wedge \mathbb{G}_m \wedge Y^n \xrightarrow{t \wedge 1} \mathbb{G}_m^{k-1} \wedge S^1 \wedge \mathbb{G}_m \wedge Y^n \xrightarrow{1 \wedge \sigma} \mathbb{G}_m^{k-1} \wedge Y^{n+1},$$

and the vertical bonding maps arise from the maps of S^1 -spectra $Y^{*,n} \wedge \mathbb{G}_m \rightarrow Y^{*,n+1}$ which are canonically determined by the twist isomorphisms

$$(\mathbb{G}_m^k \wedge Y^{n-k}) \wedge \mathbb{G}_m \xrightarrow{t} \mathbb{G}_m \wedge (\mathbb{G}_m^k \wedge Y^{n-k}).$$

for $0 \leq k \leq n$.

An S^1/\mathbb{G}_m -bispectrum X has presheaves of *bigraded stable homotopy groups* $\pi_{t,s} X$ defined in bidegree (t, s) and in U -sections to be the colimit of the system

$$\begin{array}{ccc}
 \vdots & & \vdots \\
 \uparrow & & \uparrow \\
 [S^{t+k} \wedge \mathbb{G}_m^{s+l+1}, X^{k,l+1}|_U] & \xrightarrow{\sigma_{h*}} & [S^{t+k+1} \wedge \mathbb{G}_m^{s+l+1}, X^{k+1,l+1}|_U] \longrightarrow \dots \\
 \uparrow \sigma_{v*} & & \uparrow \sigma_{v*} \\
 [S^{t+k} \wedge \mathbb{G}_m^{s+l}, X^{k,l}|_U] & \xrightarrow{\sigma_{h*}} & [S^{t+k+1} \wedge \mathbb{G}_m^{s+l}, X^{k+1,l}|_U] \longrightarrow \dots
 \end{array}$$

Here (presuming that all $X^{k,l}$ are fibrant, which is harmless), the map σ_{h*} takes a representative $\theta : S^r \wedge \mathbb{G}_m^s \rightarrow X^{k,l}$ to the composite

$$S^1 \wedge S^r \wedge \mathbb{G}_m^s \xrightarrow{S^1 \wedge \theta} S^1 \wedge X^{k,l} \xrightarrow{\sigma_h} X^{k+1,l},$$

while σ_{v*} takes θ to the composite

$$S^r \wedge \mathbb{G}_m \wedge \mathbb{G}_m^s \xrightarrow{t \wedge \mathbb{G}_m^s} \mathbb{G}_m \wedge S^r \wedge \mathbb{G}_m^s \xrightarrow{\mathbb{G}_m \wedge \theta} \mathbb{G}_m \wedge X^{k,l} \xrightarrow{\sigma_v} X^{k,l+1}.$$

The bispectrum object X determines a sequence of maps of S^1 -spectra

$$X^0 \xrightarrow{\sigma_{v*}} \Omega_{\mathbb{G}_m} X^1 \xrightarrow{\Omega_{\mathbb{G}_m}(\sigma_{v*})} \Omega_{\mathbb{G}_m}^2 X^2 \rightarrow \dots,$$

where $\Omega_{\mathbb{G}_m}$ is the functor $\mathbf{Hom}_*(\mathbb{G}_m, _)$. Then the presheaf $\pi_{t,s} X$ is the filtered colimit of the presheaves of stable homotopy groups

$$\pi_t \Omega_{\mathbb{G}_m}^{s+l} JX^l \rightarrow \pi_t \Omega_{\mathbb{G}_m}^{s+l+1} JX^{l+1} \rightarrow \dots$$

once X has been replaced up to levelwise equivalence by a levelwise fibrant object JX so that the “loop” constructions make sense.

In particular, starting with a T -spectrum X , a cofinality argument shows that the presheaves of weighted stable homotopy groups $\pi_{t,s} X$ for X as defined above coincide up to natural isomorphism with the presheaves $\pi_{t,s} X^{*,*}$ of bigraded stable homotopy groups for the associated bispectrum object $X^{*,*}$.

3.3 FIBRE AND COFIBRE SEQUENCES

A *level fibration* $p : X \rightarrow Y$ of S^1/\mathbb{G}_m -bispectra is a map which consists of fibrations $p : X^{m,n} \rightarrow Y^{m,n}$ for all $m, n \geq 0$. Level equivalences and level cofibrations have analogous definitions. One can use standard techniques to show that any map $f : X \rightarrow Y$ of S^1/\mathbb{G}_m -bispectra has a factorization

$$\begin{array}{ccc} X & \xrightarrow{f} & Y \\ & \searrow j & \nearrow p \\ & Z & \end{array}$$

where p is a level fibration and j is a level cofibration and a level equivalence.

Suppose that

$$F \xrightarrow{i} X \xrightarrow{p} Y$$

is a level fibre sequence of S^1/\mathbb{G}_m -bispectra, and suppose that Y (and hence X) is level fibrant. Then there are fibre sequences of S^1 -spectra

$$\Omega_{\mathbb{G}_m}^{s+r} F^r \xrightarrow{i_*} \Omega_{\mathbb{G}_m}^{s+r} X^r \xrightarrow{p_*} \Omega_{\mathbb{G}_m}^{s+r} Y^r$$

and hence long exact sequences in stable homotopy group presheaves

$$\dots \xrightarrow{p_*} \pi_{t+1} \Omega_{\mathbb{G}_m}^{s+r} Y^r \xrightarrow{\partial} \pi_t \Omega_{\mathbb{G}_m}^{s+r} F^r \xrightarrow{i_*} \pi_t \Omega_{\mathbb{G}_m}^{s+r} X^r \xrightarrow{p_*} \pi_t \Omega_{\mathbb{G}_m}^{s+r} Y^r \xrightarrow{\partial} \dots$$

Taking a filtered colimit in r gives a long exact sequence

$$\dots \xrightarrow{p_*} \pi_{t+1,s} Y \xrightarrow{\partial} \pi_{t,s} F \xrightarrow{i_*} \pi_{t,s} X \xrightarrow{p_*} \pi_{t,s} Y \xrightarrow{\partial} \dots \tag{3.2}$$

for each s . One can remove the condition that Y is level fibrant by using factorization tricks from the previous paragraph.

If

$$A \xrightarrow{i} B \xrightarrow{\pi} B/A$$

is a level cofibre sequence of S^1/\mathbb{G}_m -bispectra, then replacing the map π up to level equivalence by a fibration p as above gives a diagram

$$\begin{array}{ccccc} A & \xrightarrow{i} & B & \xrightarrow{\pi} & B/A \\ j_* \downarrow & & \downarrow j & & \downarrow 1_{B/A} \\ F & \longrightarrow & X & \xrightarrow{p} & B/A \end{array}$$

in which p is a level fibration and j is a level equivalence. It follows from Lemma 3.5 that the induced maps $j_* : A^n \rightarrow F^n$ are stable equivalences of S^1 -spectra. But then the induced maps

$$\pi_{t,s} A \xrightarrow{j_*} \pi_{t,s} F$$

are isomorphisms in all bidegrees. This implies that there is a natural long exact sequence

$$\dots \xrightarrow{\pi_*} \pi_{t+1,s} B/A \xrightarrow{\partial} \pi_{t,s} A \xrightarrow{i_*} \pi_{t,s} B \xrightarrow{\pi_*} \pi_{t,s} B/A \xrightarrow{\partial} \dots \tag{3.3}$$

associated to a cofibre sequence of S^1/\mathbb{G}_m -bispectra in each s . As a corollary of the construction we have

COROLLARY 3.8. *There are natural isomorphisms*

$$\pi_{t+1,s}(Y \wedge S^1) \cong \pi_{t,s} Y$$

for all bidegrees (t, s) and S^1/\mathbb{G}_m -bispectra Y .

LEMMA 3.9. *Suppose that*

$$F \xrightarrow{i} X \xrightarrow{p} Y$$

is a level fibre sequence of T -spectra. Then the induced map $X/F \rightarrow Y$ is a stable equivalence.

Proof. The idea is to show that the map $X/F \rightarrow Y$ induces isomorphisms

$$\pi_{t,s}(X/F)^{*,*} \cong \pi_{t,s}Y^{*,*}.$$

Form the diagram of maps of S^1/\mathbb{G}_m -bispectra

$$\begin{array}{ccccc} F^{*,*} & \xrightarrow{i_*} & X^{*,*} & \xrightarrow{p_*} & Y^{*,*} \\ j_* \downarrow & & \downarrow j & & \downarrow 1_{Y^{*,*}} \\ \overline{F} & \longrightarrow & Z & \xrightarrow{q} & Y^{*,*} \end{array}$$

where q is a level fibration, j is a level equivalence, and \overline{F} is the fibre of the map q . The map $j_* : F^{*,*} \rightarrow \overline{F}$ consists in part of equivalences $F^n \rightarrow \overline{F}^{n,n}$ in bidegree (n, n) for all $n \geq 0$, since the sequence

$$F^{*,*} \xrightarrow{i_*} X^{*,*} \xrightarrow{p_*} Y^{*,*}$$

is already an fibre sequence in those bidegrees. A cofinality argument therefore implies that the map $j_* : F^{*,*} \rightarrow \overline{F}$ induces isomorphisms

$$j_* : \pi_{t,s}F^{*,*} \xrightarrow{\cong} \pi_{t,s}\overline{F}$$

for all t and s .

The map $Z/\overline{F} \rightarrow Y^{*,*}$ of S^1/\mathbb{G}_m -bispectra induces isomorphisms in all $\pi_{t,s}$, since it consists of maps $Z^n/\overline{F}^n \rightarrow Y^{*,n}$ of S^1 -spectra which are stable equivalences by Lemma 3.2.

A long exact sequence argument arising from the comparison of cofibre sequences

$$\begin{array}{ccccc} F^{*,*} & \xrightarrow{i_*} & X^{*,*} & \xrightarrow{\pi_*} & (X/F)^{*,*} \\ j_* \downarrow & & \downarrow j & & \downarrow j_* \\ \overline{F} & \longrightarrow & Z & \xrightarrow{\pi} & Z/\overline{F} \end{array}$$

shows that the map $j_* : (X/F)^{*,*} \rightarrow Z/\overline{F}$ induces an isomorphism in all $\pi_{t,s}$. The result follows. \square

COROLLARY 3.10. *Suppose that*

$$A \xrightarrow{i} B \xrightarrow{\pi} B/A$$

is a level cofibre sequence of T -spectra, and take a factorization

$$\begin{array}{ccc} B & \xrightarrow{j} & X \\ & \searrow \pi & \downarrow p \\ & & B/A \end{array}$$

of the map π such that j is a level equivalence and p is a level fibration. Let F be the fibre of the map p . Then the induced map $j_* : A \rightarrow F$ is a stable equivalence.

Proof. The induced map $X/F \rightarrow B/A$ is a stable equivalence by Lemma 3.9. The map $j_* : B/A \rightarrow X/F$ is therefore a stable equivalence, so a comparison of long exact sequences argument shows that $j_* : A \rightarrow F$ is a stable equivalence. \square

3.4 T -SUSPENSIONS AND T -LOOPS

Write $j_X : X \rightarrow X_s$ for a natural choice of stably fibrant model X_s for a T -spectrum X , where j_X is a cofibration and a stable equivalence. The aim of this section is to prove and discuss the consequences of the following result:

THEOREM 3.11. *The composition*

$$X \xrightarrow{\eta_X} \Omega_T(X \wedge T) \xrightarrow{\Omega j_{X \wedge T}} \Omega_T(X \wedge T)_s$$

arising from the adjunction map η_X is a stable equivalence for all T -spectra X .

The proof of this result is a bit delicate, and will be accomplished with the help of a series of lemmas. We begin with something which is quite general:

LEMMA 3.12. *Suppose that the comparison diagram of inductive systems*

$$\begin{array}{ccccccc} X_0 & \longrightarrow & X_1 & \longrightarrow & X_2 & \longrightarrow & \cdots \\ f_0 \downarrow & & \downarrow f_1 & & \downarrow f_2 & & \\ Y_0 & \longrightarrow & Y_1 & \longrightarrow & Y_2 & \longrightarrow & \cdots \end{array}$$

consists of stable equivalences $f_i : X_i \rightarrow Y_i$. Then the induced map

$$\varinjlim f_i : \varinjlim X_i \rightarrow \varinjlim Y_i$$

is a stable equivalence.

Proof. The idea of the proof is to show that we can assume that the spectra X_i and Y_i are stably fibrant.

In effect, suppose that there are trivial cofibrations $j_i : X_i \rightarrow (X_i)_s$ and $j_i : Y_i \rightarrow (Y_i)_s$ and maps $(f_i)_* : (X_i)_s \rightarrow (Y_i)_s$ such that $(X_i)_s$ and $(Y_i)_s$ are

stably fibrant for $i \leq n$, and such that the diagrams

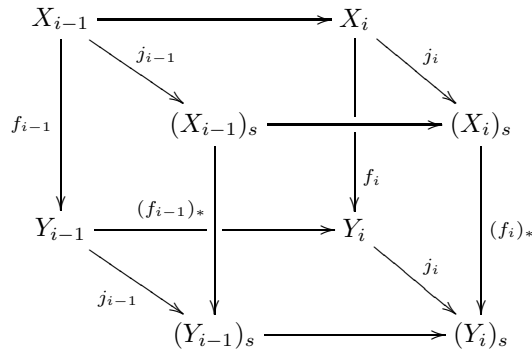

commute. Now form the commutative diagram

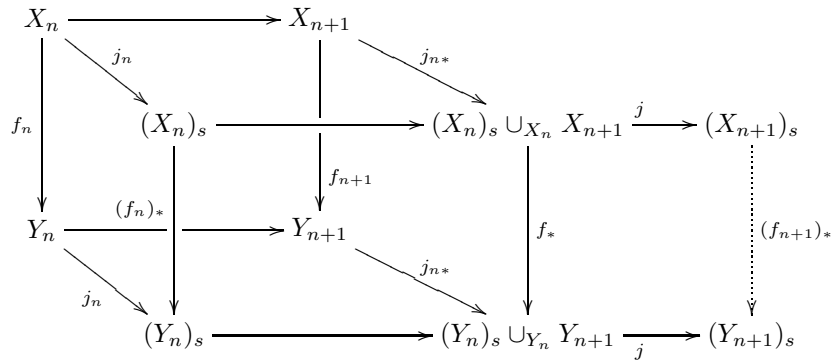

where both instances of j are trivial cofibrations, and $(X_{n+1})_s$ and $(Y_{n+1})_s$ are stably fibrant. The dotted arrow $(f_{n+1})_*$ exists by the closed model axioms, and the instances of the compositions $j_{n+1} = j \cdot j_{n*}$ are both trivial cofibrations.

In the resulting diagram

$$\begin{array}{ccc}
 \varinjlim X_n & \xrightarrow{j_*} & \varinjlim (X_n)_s \\
 f_* \downarrow & & \downarrow f_* \\
 \varinjlim Y_n & \xrightarrow{j_*} & \varinjlim (Y_n)_s
 \end{array}$$

both instances of j_* are trivial cofibrations by construction, and the map $f_* : \varinjlim (X_n)_s \rightarrow \varinjlim (Y_n)_s$ is a filtered colimit of maps which are pointwise weak equivalences in each level, and therefore shares this property. In particular, f_* is a stable equivalence. \square

We're going to need the following:

LEMMA 3.13. (Voevodsky) *The cyclic permutation $c_{1,2} = (3, 2, 1) \in \Sigma_3$ induces the identity morphism on $T^{\wedge 3} = T^3$ in the pointed motivic homotopy category.*

For the record (this comes up later), the element $c_{p,q}$ in the symmetric group Σ_{p+q} is the shuffle which moves the first p elements past the last q elements, in order. Explicitly

$$c_{p,q}(i) = \begin{cases} q + i & \text{if } i \leq p, \\ i - p & \text{if } i \geq p + 1. \end{cases}$$

Proof of Lemma 3.13. For the purposes of this proof, we shall notationally confuse T^3 with its associated sheaf, and prove the result on the sheaf level. This is harmless, since the canonical map $\eta : X \rightarrow \tilde{X}$ taking values in the associated sheaf \tilde{X} is a weak equivalence for any presheaf X .

There is an isomorphism of pointed sheaves

$$\mathbb{A}^n / (\mathbb{A}^n - 0) \wedge \mathbb{A}^1 / (\mathbb{A}^1 - 0) \cong \mathbb{A}^{n+1} / (\mathbb{A}^{n+1} - 0),$$

since

$$((\mathbb{A}^n - 0) \times \mathbb{A}^1) \cup (\mathbb{A}^n \times (\mathbb{A}^1 - 0)) = \mathbb{A}^{n+1} - 0$$

inside \mathbb{A}^{n+1} . It follows that there is an isomorphism

$$T^n \cong \mathbb{A}^n / (\mathbb{A}^n - 0).$$

There is a pointed algebraic group action

$$Gl_n \times T^n \rightarrow T^n$$

in the sheaf category which is induced by the standard action $Gl_n \times \mathbb{A}^n \rightarrow \mathbb{A}^n$. It follows that any rational point $g \in Gl_n(\mathbb{Z})$ induces a morphism of sheaves

$$g : T^n \rightarrow T^n.$$

In particular, the permutation matrix corresponding to the element $c_{1,2} = (3, 2, 1)$ induces the map

$$c_{1,2} : T^3 \rightarrow T^3$$

in the statement of the lemma.

The element

$$c_{1,2} = \begin{bmatrix} 0 & 1 & 0 \\ 0 & 0 & 1 \\ 1 & 0 & 0 \end{bmatrix}$$

is a product of elementary transformations in $Gl_3(\mathbb{Z})$, and so there is an algebraic path $\omega : \mathbb{A}^1 \rightarrow Gl_3$ such that $\omega(1) = c_{1,2}$ and $\omega(0) = e$. It follows that there is a composite pointed algebraic homotopy

$$\mathbb{A}^1 \times T^3 \xrightarrow{1 \times \omega} Gl_3 \times T^3 \rightarrow T^3$$

from $c_{1,2} : T^3 \rightarrow T^3$ to the identity on T^3 (see also Theorem 1.1 of [8]). The maps $c_{1,2}$ and e therefore coincide in the motivic homotopy category. \square

Observe that a T -spectrum X has a natural filtration

$$X \cong \varinjlim L_n X,$$

where $L_n X$ is the spectrum

$$X^0, X^1, \dots, X^n, T \wedge X^n, T^{\wedge 2} \wedge X^n, \dots$$

There is a natural pushout diagram

$$\begin{array}{ccc} \Sigma_T^\infty (T \wedge X^n)[-(n+1)] & \longrightarrow & L_n X \\ \downarrow & & \downarrow \\ \Sigma^\infty X^{n+1}[-(n+1)] & \longrightarrow & L_{n+1} X \end{array}$$

Note further that the canonical map $\Sigma_T^\infty X^n[-n] \rightarrow L_n X$ is a stable equivalence. The filtration $\{L_n X\}$ is called the *layer filtration* of X .

LEMMA 3.14. *Suppose that K is a pointed simplicial presheaf. Then the composition*

$$\Sigma_T^\infty K \xrightarrow{\eta} \Omega_T((\Sigma_T^\infty K) \wedge T) \xrightarrow{\Omega j} \Omega_T((\Sigma_T^\infty K) \wedge T)_s$$

is a stable equivalence.

Proof. Recall that if Y is a spectrum, then the homotopy group presheaves $\pi_r Y_s^n(U)$ of the stably fibrant model $Y_s = IQ_T JY$ are computed by the filtered colimits

$$[S^r, Y^n]_U \xrightarrow{\Sigma} [T \wedge S^r, Y^{n+1}]_U \xrightarrow{\Sigma} \dots$$

where $[K, X]_U = [K|_U, X|_U]$ means homotopy classes of maps of the restrictions to the site over U . The suspension homomorphism Σ takes a morphism $\theta : T^k \wedge S^r \rightarrow Y^{n+k}$ to the composite

$$T \wedge T^k \wedge S^r \xrightarrow{T \wedge \theta} T \wedge Y^{n+k} \xrightarrow{\sigma} Y^{n+k+1}$$

Practically speaking, the suspension morphism Σ is induced by smashing with T on the left.

Observe as well that if Y is level fibrant, then the adjunction isomorphisms

$$[T^k \wedge S^r, \Omega_T Y^{n+k}]_U \cong [T^k \wedge S^r \wedge T, Y^{n+k}]_U$$

fit into commutative diagrams

$$\begin{array}{ccc} [T^k \wedge S^r, \Omega_T Y^{n+k}]_U & \xrightarrow{\cong} & [T^k \wedge S^r \wedge T, Y^{n+k}]_U \\ \Sigma \downarrow & & \downarrow \Sigma \\ [T^{k+1} \wedge S^r, \Omega_T Y^{n+k+1}]_U & \xrightarrow{\cong} & [T^{k+1} \wedge S^r \wedge T, Y^{n+k+1}]_U \end{array}$$

It follows that the map in presheaves of stable homotopy groups induced by the composite

$$\Sigma_T^\infty K \xrightarrow{\eta} \Omega_T((\Sigma_T^\infty K) \wedge T) \xrightarrow{\Omega j} \Omega_T((\Sigma_T^\infty K) \wedge T)_s$$

is isomorphic to the filtered colimit of the maps

$$[T^k \wedge S^r, T^{n+k} \wedge K]_U \xrightarrow{\wedge T} [T^k \wedge S^r \wedge T, T^{n+k} \wedge K \wedge T]_U$$

which are induced by smashing with T on the right.

Suppose that $\phi : K \wedge T \rightarrow X \wedge T$ is a map of pointed simplicial presheaves, and write $c_t(\phi)$ for the map $T \wedge K \rightarrow T \wedge X$ arises from ϕ by conjugation with the twist of smash factors. There is a commutative diagram

$$\begin{array}{ccc} K \wedge T & \xrightarrow[t]{\cong} & T \wedge K \\ \phi \downarrow & & \downarrow c_t(\phi) \\ X \wedge T & \xrightarrow[t]{\cong} & T \wedge X \end{array}$$

Then there is a diagram

$$\begin{array}{ccccc} T \wedge T^2 \wedge K & \xleftarrow{t} & T^2 \wedge K \wedge T & \xrightarrow{T^2 \wedge t} & T^2 \wedge T \wedge K \\ c_t(T^2 \wedge \phi) \downarrow & & \downarrow T^2 \wedge \phi & & \downarrow T^2 \wedge c_t(\phi) \\ T \wedge T^2 \wedge X & \xleftarrow[t]{} & T^2 \wedge X \wedge T & \xrightarrow{T^2 \wedge t} & T^2 \wedge T \wedge X \end{array}$$

and hence a diagram

$$\begin{array}{ccc} T^3 \wedge K & \xrightarrow{c_{1,2} \wedge K} & T^3 \wedge K \\ c_t(T^2 \wedge \phi) \downarrow & & \downarrow T^2 \wedge c_t(\phi) \\ T^3 \wedge K & \xrightarrow{c_{1,2} \wedge K} & T^3 \wedge X \end{array}$$

It follows from Lemma 3.13 that the maps in the homotopy category represented by $T^2 \wedge c_t(\phi)$ and $c_t(T^2 \wedge \phi)$ coincide.

As a consequence, there are commutative diagrams

$$\begin{array}{ccc}
 [T^k \wedge S^r, T^{n+k} \wedge K]_U & \xrightarrow{T^2 \wedge} & [T^2 \wedge T^k \wedge S^r, T^2 \wedge T^{n+k} \wedge K]_U \\
 \wedge T \downarrow & & \downarrow \wedge T \\
 [T^k \wedge S^r \wedge T, T^{n+k} \wedge K \wedge T]_U & \xrightarrow{T^2 \wedge} & [T^2 \wedge T^k \wedge S^r \wedge T, T^2 \wedge T^{n+k} \wedge K \wedge T]_U \\
 c_t \downarrow \cong & & \cong \downarrow c_t \\
 [T \wedge T^k \wedge S^r, T \wedge T^{n+k} \wedge K]_U & \xrightarrow{T^2 \wedge} & [T^3 \wedge T^k \wedge S^r, T^3 \wedge T^{n+k} \wedge K]_U
 \end{array}$$

The vertical composites coincide with the map $T \wedge$ induced by smashing on the left with T , so a cofinality argument says that the induced map on the filtered colimits is an isomorphism. \square

Proof of Theorem 3.11. It is a consequence of Lemma 2.11 that the functor $X \mapsto X \wedge T$ preserves stable equivalences. It follows that the functors $X \mapsto X$ and $X \mapsto \Omega_T(X \wedge T)_s$ both preserve stable equivalences. The T -spectrum X is a filtered colimit of its layers $L_n X$, and there is a stable equivalence

$$\Sigma_T^\infty X^n[-n] \rightarrow L_n X$$

for $n \geq 0$. Write $\eta_* : X \rightarrow \Omega_T(X \wedge T)_s$ for the composite in the statement of Theorem 3.11. The proof consists of showing that all maps

$$\Sigma_T^\infty K[-n] \xrightarrow{\eta_*} \Omega_T(\Sigma_T^\infty K[-n] \wedge T)_s \tag{3.4}$$

are stable equivalences. Then we show that these equivalences pass appropriately to filtered colimits.

Shifts preserve stable equivalence, so it suffices to consider the case of the map (3.4) corresponding to $n = 0$, but this is Lemma 3.14.

Suppose given a system

$$X_0 \rightarrow X_1 \rightarrow \dots$$

of T -spectra such that all maps

$$\eta_* : X_i \rightarrow \Omega_T(X_i \wedge T)_s$$

are stable equivalences. I claim that the induced map

$$\eta_* : \varinjlim X_i \rightarrow \Omega_T((\varinjlim X_i) \wedge T)_s$$

is a stable equivalence. The composite

$$\varinjlim X_i \xrightarrow{\varinjlim \eta} \varinjlim \Omega_T(X_i \wedge T) \xrightarrow{\varinjlim \Omega_T j} \varinjlim \Omega_T(X_i \wedge S)_s$$

is a stable equivalence by Lemma 3.12. There is a commutative diagram

$$\begin{array}{ccc} \varinjlim(X_i \wedge T) & \xrightarrow{\varinjlim j} & \varinjlim(X_i \wedge T)_s \\ \cong \downarrow & & \downarrow c \\ (\varinjlim X_i) \wedge T & \xrightarrow{j} & ((\varinjlim X_i) \wedge T)_s \end{array}$$

The map $\varinjlim j$ is a stable equivalence by Lemma 3.12, and so the map c is a pointwise weak equivalence of motivic flasque objects in all levels by a Nisnevich descent argument (Corollary 1.7). There is also a commutative diagram

$$\begin{array}{ccccc} \varinjlim X_i & \xrightarrow{\eta} & \Omega_T((\varinjlim X_i) \wedge T) & \xrightarrow{\Omega_T j} & \Omega_T((\varinjlim X_i) \wedge T)_s \\ & \searrow & \uparrow \cong & & \uparrow \Omega_T c \\ & & \Omega_T \varinjlim(X_i \wedge T) & \xrightarrow{\Omega_T j} & \Omega_T \varinjlim(X_i \wedge T)_s \\ & \swarrow \varinjlim \eta & \uparrow \cong & & \uparrow \cong \\ \varinjlim \Omega_T(X_i \wedge T) & \xrightarrow{\varinjlim \Omega_T j} & \varinjlim \Omega_T(X_i \wedge T) & & \end{array}$$

The map $\Omega_T c$ is a pointwise weak equivalence in all levels, so the composite

$$\varinjlim X_i \xrightarrow{\eta} \Omega_T((\varinjlim X_i) \wedge T) \xrightarrow{\Omega_T j} \Omega_T((\varinjlim X_i) \wedge T)_s$$

is a stable equivalence. □

LEMMA 3.15. *Suppose that X is level fibrant. Then there is an isomorphism*

$$Q_T(\Omega_T X)^n \cong \Omega_T(Q_T X)^n.$$

In particular, the loop functor $X \mapsto \Omega_T X$ preserves stable equivalences of level fibrant objects.

Proof. Recall that $\Omega_T X$ has bonding map $\sigma : T \wedge \Omega_T X^n \rightarrow \Omega_T X^{n+1}$ adjoint to the composite

$$T \wedge \Omega_T X^n \wedge T \xrightarrow{T \wedge ev} T \wedge X^n \xrightarrow{\sigma} X^{n+1}$$

It follows that there is a commutative diagram

$$\begin{array}{ccc} \Omega_T X^n & \xrightarrow{\sigma_*} & \Omega_T^2 X^{n+1} \\ & \searrow \Omega_T \sigma_* & \downarrow \cong t^* \\ & & \Omega_T^2 X^{n+1} \end{array}$$

where t^* is the map which flips loop factors. Inductively, one finds diagrams

$$\begin{array}{ccc}
 \Omega_T^{k+1} X^{n+k} & \xrightarrow{\Omega_T^k \sigma_*} & \Omega_T^{k+2} X^{n+k+1} \\
 c_{k,1}^* \downarrow \cong & & \cong \downarrow c_{k+1,1}^* \\
 \Omega_T^{k+1} X^{n+k} & \xrightarrow{\Omega_T^{k+1} \sigma_*} & \Omega_T^{k+2} X^{n+k+1}
 \end{array}$$

where $c_{k,1}^*$ is precomposition with the map which is induced by the shuffle $c_{k,1}$ in the loop factors. The maps $c_{k,1}^*$ therefore induce the desired isomorphism. \square

COROLLARY 3.16. *Suppose that Y is level fibrant. Then the evaluation map*

$$ev : \Omega_T Y \wedge T \rightarrow Y$$

is a stable equivalence.

Proof. The functor $Y \mapsto Y \wedge T$ preserves stable equivalences, so Lemma 3.15 implies that it suffices to assume that Y is stably fibrant.

Take a stably fibrant model $j : \Omega_T Y \wedge T \rightarrow (\Omega_T Y \wedge T)_s$ (j is a cofibration as well as a stable equivalence), and form the diagram

$$\begin{array}{ccc}
 \Omega_T Y \wedge T & \xrightarrow{j} & (\Omega_T Y \wedge T)_s \\
 ev \downarrow & \swarrow \tilde{ev} & \\
 Y & &
 \end{array}$$

The idea is to show that \tilde{ev} is a stable equivalence by showing that $\Omega_T \tilde{ev}$ is a stable equivalence. This works, on account of the natural isomorphism

$$\pi_{t,s} \Omega_T X \cong \pi_{t+1,s+1} X$$

for level fibrant objects X — this isomorphism is another consequence of Lemma 3.15. There is a diagram

$$\begin{array}{ccc}
 \Omega_T Y & & \\
 \Omega_T \eta \downarrow & \searrow \Omega_T \eta_* & \\
 \Omega_T(\Omega_T Y \wedge T) & \xrightarrow{\Omega_T j} & \Omega_T(\Omega_T Y \wedge T)_s \\
 \Omega_T ev \downarrow & \swarrow \Omega_T \tilde{ev} & \\
 \Omega_T Y & &
 \end{array}$$

The map $\Omega_T \eta_*$ is a pointwise equivalence by Theorem 3.11, and so $\Omega_T \tilde{ev}$ is a stable equivalence. \square

COROLLARY 3.17. *Let $j : Y \rightarrow Y_s$ be a choice of stably fibrant model for Y . Then a map $g : X \wedge T \rightarrow Y$ is a stable equivalence if and only if the composite*

$$X \xrightarrow{g_*} \Omega_T Y \xrightarrow{\Omega_T j} \Omega_T Y_s$$

is a stable equivalence, where g_* is the adjoint of g .

Proof. There is a diagram

$$\begin{array}{ccc} X \wedge T & \xrightarrow{j} & (X \wedge T)_s \\ \downarrow g & & \downarrow \tilde{g} \\ Y & \xrightarrow{j} & Y_s \end{array}$$

where both maps labeled j are stably fibrant models. Then g is a stable equivalence if and only if \tilde{g} is a stable equivalence if and only if the composite

$$X \xrightarrow{\eta_*} \Omega_T (X \wedge T)_s \xrightarrow{\Omega_T \tilde{g}} \Omega_T Y_s$$

is a stable equivalence. □

COROLLARY 3.18. *A map $g : X \rightarrow Y$ is a stable equivalence if and only if the suspension $g \wedge T : X \wedge T \rightarrow Y \wedge T$ is a stable equivalence.*

In the final part of this section we show that all of the usual candidates for suspension functors on T -spectra are naturally equivalent in the motivic stable category. This is the content of the next two lemmas. As a corollary, all of the corresponding loop functors are naturally stably equivalent.

LEMMA 3.19. *The canonical map $\sigma : \Sigma_T^\ell X \rightarrow X[1]$ from the fake suspension $\Sigma_T^\ell X$ to the shift $X[1]$ is a natural stable equivalence.*

Proof. The map

$$\sigma : \Sigma_T^\ell(\Sigma_T^\infty K[-n]) \rightarrow (\Sigma_T^\infty K[-n])[1]$$

is an isomorphism in level p for $p \geq n$ and for all $n \geq 0$. The fake suspension $X \mapsto \Sigma_T^\ell X$ and shift $X \mapsto X[1]$ functors preserve colimits, so we can argue along the layer filtration using Lemma 3.12. It therefore suffices to show that both functors preserve stable equivalence.

In order to see that the shift functor $X \mapsto X[1]$ preserves stable equivalences, it suffices to show that the shift $X[1] \rightarrow (IQ_T JX)[1]$ of the canonical stable equivalence is a stable equivalence. For this, it enough to show that the shifted map $(JX)[1] \rightarrow (Q_T JX)[1]$ is a stable equivalence, but this is a consequence of the isomorphism $(Q_T JX)[1] \cong Q_T(JX[1])$.

The fake loop functor $X \mapsto \Omega_T^\ell X$ preserves stably fibrant objects, according to the characterization given by Lemma 2.7 and Lemma 2.8. The fake suspension functor $Y \mapsto \Sigma_T^\ell Y$ preserves level cofibrations and level weak equivalences,

so that the fake loop functor preserves injective fibrations by adjointness. It follows that the fake loop functor preserves the class of stably fibrant injective objects.

We know from Corollary 2.12 that a map $f : X \rightarrow Y$ is a stable equivalence if and only if it induces a weak equivalence

$$f^* : \mathbf{hom}(Y, W) \rightarrow \mathbf{hom}(X, W)$$

for all stably fibrant injective W . If $f : X \rightarrow Y$ is a stable equivalence of T -spectra and W is stably fibrant and injective, then the map

$$(\Sigma_T^\ell f)^* : \mathbf{hom}(\Sigma_T^\ell Y, W) \rightarrow \mathbf{hom}(\Sigma_T^\ell X, W)$$

is isomorphic to the map

$$f^* : \mathbf{hom}(Y, \Omega_T^\ell W) \rightarrow \mathbf{hom}(X, \Omega_T^\ell W),$$

and is therefore a weak equivalence since $\Omega_T^\ell W$ is stably fibrant and injective. It follows that $\Sigma_T^\ell f : \Sigma_T^\ell X \rightarrow \Sigma_T^\ell Y$ is a stable equivalence. \square

LEMMA 3.20. *The fake suspension functor $X \mapsto \Sigma_T^\ell X$ is naturally stably equivalent to the functor $X \mapsto X \wedge T$.*

Proof. Both functors preserve level equivalences, so it suffices to assume that X (by taking associated sheaves) is a sheaf of T -spectra, where T and all of its smash powers are notationally confused with their associated sheaves. We do this so that we can use the explicit pointed algebraic homotopy $h : T^3 \times \mathbb{A}^1 \rightarrow T^3$ from $c_{1,2}$ to the identity which appears in the proof of Lemma 3.13. Write $d^a : T^3 \rightarrow T^3 \times \mathbb{A}^1$ for the map which is induced by the rational point $a : * \rightarrow \mathbb{A}^1$. Then hd^0 is the identity map on T^3 and $hd^1 = c_{1,2} : T^3 \rightarrow T^3$.

Recall that the fake suspension $\Sigma_T^\ell X$ consists of the objects $T \wedge X^n$ and bonding maps $T \wedge \sigma : T^2 \wedge X^n \rightarrow T \wedge X^{n+1}$. The object $X \wedge T$ consists of the pointed simplicial presheaves $X^n \wedge T$ and bonding maps $\sigma \wedge T : T \wedge X^n \wedge T \rightarrow X^{n+1} \wedge T$. After twisting along the isomorphisms $t : X^n \wedge T \cong T \wedge X^n$, we can identify $X \wedge T$ up to isomorphism with a spectrum consisting of objects $T \wedge X^n$ and having bonding maps σ given by the composites

$$T^2 \wedge X^n \xrightarrow{t \wedge X^n} T^2 \wedge X^n \xrightarrow{T \wedge \sigma} T \wedge X^{n+1}$$

It follows that there are commutative diagrams

$$\begin{array}{ccccc} T^3 \wedge X^n & \xrightarrow{T^2 \wedge \sigma} & T^2 \wedge X^{n+1} & \xrightarrow{T \wedge \sigma} & T \wedge X^{n+2} \\ c_{1,2} \wedge X^n \downarrow & & & \nearrow \sigma & \\ T^3 \wedge X^n & \xrightarrow{T \wedge \sigma} & T^2 \wedge X^{n+1} & & \end{array}$$

The method of proof is to show that the “partial spectrum” objects X_1 and X_2 , having constituent simplicial presheaves

$$X_1^n = X_2^n = T \wedge X^{2n}$$

and bonding maps $T^2 \wedge X_i^n \rightarrow X_i^{n+1}$ defined by the composites

$$\sigma_1 = (T \wedge \sigma)(T^2 \wedge \sigma)$$

and $\sigma_2 = \sigma(T \wedge \sigma)$ respectively (as in the diagram) are naturally stably equivalent.

The idea is to use the natural algebraic homotopies $h : T^3 \wedge X^{2n} \times \mathbb{A}^1 \rightarrow T \wedge X^{2n+2}$ from σ_1 to σ_2 and the constant algebraic homotopies c on σ_1 to define natural level weak equivalences

$$X_2 \xleftarrow{h_*} \text{Tel}(X_1) \xrightarrow{c_*} X_1$$

where $\text{Tel}(X_1)$ is the *algebraic telescope*. The construction is by exact analogy with that of the ordinary mapping telescope given in [11, pp.11–15]. To summarize, one inductively constructs a sequence of trivial cofibrations

$$X_1^n \xrightarrow{j_n} CX_1^n \xrightarrow{\alpha_n} \text{Tel}(X_1)^n,$$

where j_n is the inclusion of X_1^n in the algebraic mapping cylinder CX_1^n given by the pushout diagram

$$\begin{array}{ccc} T^2 \wedge X_1^{n-1} & \xrightarrow{\sigma_1} & X_1^n \\ d^0 \downarrow & & \downarrow j_n \\ T^2 \wedge X_1^{n-1} \times \mathbb{A}^1 & \xrightarrow{\zeta_n} & CX_1^n \end{array}$$

and α_n is inductively defined by the pushout diagram

$$\begin{array}{ccccc} T^2 \wedge X_1^{n-1} & \xrightarrow{d^1} & T^2 \wedge X_1^{n-1} \times \mathbb{A}^1 & \xrightarrow{\zeta_n} & CX_1^n \\ j_{n-1} \downarrow & & & & \downarrow \alpha_n \\ T^2 \wedge CX_1^{n-1} & & & & \\ T^2 \wedge \alpha_{n-1} \downarrow & & & & \\ T^2 \wedge \text{Tel}(X_1)^{n-1} & \xrightarrow{\sigma} & & & \text{Tel}(X_1)^n \end{array}$$

The bonding maps $\sigma : T^2 \wedge \text{Tel}(X_1)^{n-1} \rightarrow \text{Tel}(X_1)^n$ are also defined by this construction. The identity on X_1^n and $h : T^2 \wedge X_1^n \times \mathbb{A}^1 \rightarrow T \wedge X_1^{n+1}$ together determine a weak equivalence $\hat{h} : CX_1^n \rightarrow X_2^n$ and the map \hat{h} extends levelwise along the trivial cofibrations $\alpha_n : CX_1^n \rightarrow \text{Tel}(X_1)^n$ to a natural map of partial spectra $h_* : \text{Tel}(X_1) \rightarrow X_2$. The map h_* is a levelwise weak equivalence. \square

COROLLARY 3.21. *Suppose that X is a level fibrant spectrum. Then the spectra $\Omega_T^\ell X$, $\Omega_T X$ and $X[-1]$ are naturally stably equivalent.*

Remark 3.22. A statement analogous to Theorem 3.11 is true for S^1 -spectra, in that the composite

$$X \xrightarrow{\eta_X} \Omega(X \wedge S^1) \xrightarrow{\Omega(j_X \wedge T)} \Omega(X \wedge S^1)_s$$

is a natural weak equivalence in the motivic stable model structure for S^1 -spectra. The proof is formally the same as that displayed for Theorem 3.11, with T replaced by S^1 . The key is that it is well known that the cyclic permutation $c_{1,2}$ acts trivially in the ordinary homotopy category on S^3 . With suitable modifications, the rest of the statements up to Corollary 3.18 also hold formally for S^1 -spectra, so that the suspension and loop functors determine a self equivalence of categories for the motivic stable category of S^1 -spectra, as one would expect. The analogues of Lemma 3.19 and Lemma 3.20 for S^1 -spectra follow from standard results of stable homotopy theory, along with Lemma 3.1.

4 MOTIVIC SYMMETRIC SPECTRA

We continue to work within motivic homotopy theory on the smooth Nisnevich site $(Sm|_S)_{Nis}$, meaning that we formally contract the affine line onto a rational point within the associated category of simplicial presheaves. As before, T denotes either the quotient $\mathbb{A}^1/(\mathbb{A}^1 - 0)$ or the equivalent object $S^1 \wedge \mathbb{G}_m$. As in all discussions of geometric theories, one tacitly assumes that all objects in $(Sm|_S)_{Nis}$ (including the base scheme S) are bounded above by a fixed large cardinal, and that the category itself is a skeleton. This means that the site is small, and so its morphisms form a set. We shall assume that α is an infinite cardinal which is an upper bound for the cardinality of the set of morphisms of this site.

A *symmetric T -spectrum* X on the Nisnevich site $(Sm|_S)_{Nis}$ is a T -spectrum together with symmetric group actions $\Sigma_n \times X^n \rightarrow X^n$ such that the composite bonding maps $T^p \wedge X^n \rightarrow X^{p+n}$ is $(\Sigma_p \times \Sigma_n)$ -equivariant. A map $f : X \rightarrow Y$ of such objects is a map of T -spectra which is equivariant in each level for the ambient symmetric group action. The resulting category will be denoted by $\mathbf{Spt}_T^\Sigma(Sm|_S)_{Nis}$. This category is complete and cocomplete.

The most primitive example of a symmetric T -spectrum is the *sphere T -spectrum*, which will be denoted by T . Explicitly,

$$T^n = \begin{cases} S^0 & \text{if } n = 0, \\ T^{\wedge n} & \text{if } n > 0. \end{cases}$$

with the obvious isomorphisms $T \wedge T^n \cong T^{n+1}$ as bonding maps.

4.1 THE LEVEL STRUCTURE

Say that a map $f : X \rightarrow Y$ of symmetric T -spectra is a *level equivalence* if each of the component maps $f : X^n \rightarrow Y^n$ is a motivic equivalence. The map f is said to be a *level cofibration* if each of the maps $X^n \rightarrow Y^n$ is a cofibration of simplicial presheaves. Write \mathbf{sE} for the class of level equivalences in the category of symmetric T -spectra.

PROPOSITION 4.1. *The class \mathbf{sE} of level equivalences and the class of level cofibrations of symmetric T -spectra together satisfy the following properties:*

SE1: *The class of morphisms \mathbf{sE} is closed under retracts.*

SE2: *Given a composable pair of morphisms*

$$X \xrightarrow{f} Y \xrightarrow{g} Z,$$

if any two of f , g and gf are in the class \mathbf{sE} , then so is the third.

SE3: *Every pointwise level equivalence is in \mathbf{sE} .*

SE4: *The class of \mathbf{sE} -trivial cofibrations is closed under pushout.*

SE5: *Suppose that γ is a limit ordinal, and there is a functor*

$$X : \gamma \rightarrow \mathbf{Spt}_T^\Sigma(\mathit{Sm}|_S)_{Nis}$$

such that for each morphism $i \leq j$ of γ , the induced map $X(i) \rightarrow X(j)$ is an \mathbf{sE} -trivial cofibration. Then the canonical maps

$$X(i) \xrightarrow{\tau_i} \varinjlim_{j \in \gamma} X(j)$$

are \mathbf{sE} -trivial cofibrations.

SE6: *Suppose that the morphisms $f_i : X_i \rightarrow Y_i$ are \mathbf{sE} -trivial cofibrations for $i \in I$. Then the morphism*

$$\bigvee_{i \in I} f_i : \bigvee_{i \in I} X_i \rightarrow \bigvee_{i \in I} Y_i$$

is an \mathbf{E} -trivial cofibration.

SE7: *There is an infinite cardinal λ which is at least as large as the cardinality of the set of morphisms of $(\mathit{Sm}|_S)_{Nis}$, such that for every diagram*

$$\begin{array}{ccc} & & X \\ & & \downarrow i \\ A & \longrightarrow & Y \end{array}$$

of maps of T -spectra with i a \mathbf{sE} -trivial cofibration, and A α -bounded, there is an α -bounded subobject $B \subset Y$ such that $A \subset B$, and such that the inclusion $B \cap X \hookrightarrow B$ is an \mathbf{sE} -trivial cofibration.

A *pointwise level equivalence* is a map $f : X \rightarrow Y$ of symmetric T -spectra such that all maps $f : X^n(U) \rightarrow Y^n(U)$ are weak equivalences of simplicial sets in all sections and levels. An **sE**-trivial level cofibration is a map of symmetric T -spectra which is both a level equivalence and a level cofibration.

Proof. Every weak equivalence of simplicial presheaves is a motivic equivalence, giving sE3. With the exception of sE7, the remaining statements are due to the existence of the motivic closed model structure for the category of simplicial presheaves on $(Sm|_S)_{Nis}$.

The proof of sE7 is analogous to the proof of Proposition 2.15. One begins by showing, using the method of proof of Lemma 1 of [13], that the class of maps which are level local weak equivalences and level cofibrations has the bounded cofibration property with respect to the cardinal λ . The argument is then completed just as in the last paragraph of the proof of Proposition 2.15 by using the controlled level fibrant model construction $X \mapsto \mathcal{L}X$ in place of the functor F . □

A *symmetric sequence* X consists of pointed simplicial presheaves X^n , $n \geq 0$, each of which carries a symmetric group action $\Sigma_n \times X^n \rightarrow X^n$. There is an obvious category of such things. The *product* $X \otimes Y$ in the category of symmetric sequences is defined by

$$(X \otimes Y)^n = \bigvee_{p+q=n} \Sigma_n \otimes_{(\Sigma_p \times \Sigma_q)} X^p \wedge Y^q.$$

A symmetric sequence map $f : X \otimes Y \rightarrow Z$ therefore consists of $(\Sigma_p \times \Sigma_q)$ -equivariant pointed maps $f : X^p \wedge Y^q \rightarrow Z^{p+q}$, so that a symmetric T -spectrum Z can be identified with a symmetric sequence carrying a T -module structure, or a symmetric sequence map $\sigma : T \otimes Z \rightarrow Z$. Note that there is a canonical twist isomorphism $\tau : X \otimes Y \rightarrow Y \otimes X$ which is determined by the composites

$$X^p \wedge Y^q \xrightarrow{t} Y^q \wedge X^p \xrightarrow{in_e} (Y \otimes X)^{q+p} \xrightarrow{c_{q,p}} (Y \otimes X)^{p+q}.$$

Here, t is the canonical twist of smash factors and in_e is the inclusion corresponding to the coset of the identity e in

$$(Y \otimes X)^{q+p} \cong \bigvee_{\Sigma_{q+p}/(\Sigma_q \times \Sigma_p)} Y^q \wedge X^p.$$

Following [7] and [13], given a pointed simplicial presheaf K , the *free symmetric sequence* $G_n K$ consists of the simplicial presheaf

$$\Sigma_n \otimes K = \bigvee_{\sigma \in \Sigma_n} K,$$

concentrated in level n , and the *free symmetric T -spectrum* $F_n(K) = T \otimes G_n K$ is defined at level p by

$$F_n(K)^p = (T \otimes G_n K)^p = \Sigma_p \otimes_{\Sigma_{p-n} \times \Sigma_n} (T^{p-n} \wedge (\bigvee_{\sigma \in \Sigma_n} K)).$$

The object $F_n(K)$ is free in the sense that morphisms $F_n(K) \rightarrow X$ in the category of symmetric T -spectra are in one to one correspondence with pointed simplicial presheaf maps $K \rightarrow X^n$.

An *injective fibration* in the category of symmetric T -spectra is a map which has the right lifting property with respect to all morphisms which are both level cofibrations and level equivalences. It follows from the existence of the free object functors $K \mapsto F_n(K)$ that every injective fibration $p : X \rightarrow Y$ is a level fibration in the sense that it consists of fibrations $p : X^n \rightarrow Y^n$ in all levels.

THEOREM 4.2. *The category*

$$\mathbf{Spt}_T^\Sigma(Sm|_S)_{Nis}$$

of symmetric T -spectra on the smooth Nisnevich site, together with the classes of level cofibrations, level equivalences and injective fibrations, satisfies the axioms for a proper closed simplicial model category.

Proof. The proof proceeds just like that of Theorem 3 of [13], using the method of [4] and Proposition 4.1. The function complex $\mathbf{hom}(X, Y)$ giving the simplicial structure is defined in n -simplices in the usual way by

$$\mathbf{hom}(X, Y)_n = \mathbf{hom}(X \wedge \Delta_+^n, Y),$$

where the pointed simplicial set Δ_+^n is the result of attaching a disjoint base point to the standard n -simplex. □

The functor

$$U : \mathbf{Spt}_T^\Sigma(Sm|_S)_{Nis} \rightarrow \mathbf{Spt}_T(Sm|_S)_{Nis}$$

taking values in T -spectra forgets the symmetric group actions. The functor U has a left adjoint *symmetrization functor* V such that for $n \geq 0$

$$V(\Sigma_T^\infty K[-n]) = F_n(K),$$

where $\Sigma_T^\infty K$ is the suspension T -spectrum

$$K, T \wedge K, T^2 \wedge K, \dots$$

and $\Sigma_T^\infty K[r]$ is the result of shifting in the usual way:

$$\Sigma_T^\infty K[r]^p = (\Sigma_T^\infty K)^{r+p}.$$

As in Section 3.4, every T -spectrum X has a layer filtration

$$X = \varinjlim L_n X$$

and V preserves colimits, so that

$$VX = \varinjlim VL_n X,$$

and there are pushouts

$$\begin{array}{ccc} F_{n+1}(T \wedge X^n) & \longrightarrow & VL_n X \\ \sigma_* \downarrow & & \downarrow \\ F_{n+1}(X^{n+1}) & \longrightarrow & VL_{n+1} X. \end{array}$$

in the category of symmetric T -spectra.

There is a natural isomorphism of T -spectra

$$(UW)^K \cong U(W^K),$$

which induces a simplicial adjunction isomorphism

$$\mathbf{hom}(VA, W) \cong \mathbf{hom}(A, UW).$$

We shall also need the following:

LEMMA 4.3. *The functor V takes cofibrations of T -spectra to level cofibrations of symmetric T -spectra.*

Proof. The proof is just like that of Lemma 5 of [13], and begins with the observation that the functor

$$K \mapsto V(\Sigma_T^\infty K[-n]) = F_n(K)$$

takes cofibrations of pointed simplicial presheaves to level cofibrations of symmetric T -spectra for $n \geq 0$. \square

4.2 THE STABLE STRUCTURE

Say that a map $p : X \rightarrow Y$ of symmetric T -spectra is a *stable fibration* if the underlying map $p_* : UX \rightarrow UY$ is a stable fibration of T -spectra.

PROPOSITION 4.4. *Every map $f : X \rightarrow Y$ of symmetric T -spectra has a natural factorization*

$$\begin{array}{ccc} X & \xrightarrow{j} & Z \\ & \searrow f & \downarrow p \\ & & Y \end{array}$$

such that p is a stable fibration, and j is a level cofibration which has the left lifting property with respect to all stable fibrations.

Proof. By the methods of [4] and Corollary 2.16, a map of symmetric T -spectra is a stable fibration if and only if it has the right lifting property with respect to all maps $i_* : VA \rightarrow VB$ induced by λ -bounded cofibrations $i : A \rightarrow B$ which are stable equivalences. The factorization is constructed by a transfinite small object argument of size $\beta > 2^\lambda$, as in the proof of Lemma 6 of [13]. \square

Observe that if j is a level cofibration which has the left lifting property with respect to all stable fibrations, then j induces a trivial fibration

$$j^* : \mathbf{hom}(Z, W) \rightarrow \mathbf{hom}(X, W)$$

of simplicial sets for each stably fibrant object W , by appropriate use of Quillen’s axiom SM7 for the motivic stable closed model structure on the category of T -spectra.

It follows from Theorem 4.2 and Proposition 4.4 that any morphism $f : X \rightarrow Y$ of symmetric T -spectra may be successively factored

$$\begin{array}{ccccc} X & \xrightarrow{i_1} & X_s & \xrightarrow{i_2} & X_{si} \\ & \searrow f & & \searrow p_1 & \downarrow p_2 \\ & & & & Y \end{array}$$

where

- 1) i_1 is a level cofibration which has the left lifting property with respect to all stable fibrations, and p_1 is a stable fibration;
- 2) i_2 is a level cofibration and a level equivalence, and p_2 is an injective fibration.

In particular, Up_2 is a level fibration, which is level equivalent to the stable fibration Up_1 , so that p_2 is a stable fibration by Lemma 2.7 as well as an injective fibration of symmetric T -spectra. By specializing to $Y = *$, we obtain a natural construction

$$X \xrightarrow{i_1} X_s \xrightarrow{i_2} X_{si}$$

of an *injective stably fibrant model* X_{si} for a given symmetric T -spectrum X .

Say that a map $f : X \rightarrow Y$ of symmetric T -spectra is a *stable equivalence* if it induces a weak equivalence of Kan complexes

$$f^* : \mathbf{hom}(Y, W) \rightarrow \mathbf{hom}(X, W)$$

for each injective stably fibrant object W . The maps i_1 and i_2 above are both stable equivalences. Following [13] we can also show

LEMMA 4.5. *Suppose that the objects X and Y are stably fibrant and injective. Then a map $g : X \rightarrow Y$ is a stable equivalence if and only if it is a level equivalence.*

Proof. If g is a stable equivalence, then the map

$$g^* : \mathbf{hom}(Y, X) \rightarrow \mathbf{hom}(X, X)$$

is a weak equivalence of Kan complexes, since X is stably fibrant and injective. It follows that g is a homotopy equivalence.

The converse follows from the closed simplicial model structure for level cofibrations and level weak equivalences for symmetric T -spectra, since all symmetric T -spectra are cofibrant and all stably fibrant injective objects W are fibrant for that theory. \square

COROLLARY 4.6. *Suppose that X and Y are stably fibrant objects. Then a map $g : X \rightarrow Y$ is a stable equivalence if and only if it is a level equivalence.*

Suppose that Z is a symmetric T -spectrum and that K is a pointed simplicial presheaf. The symmetric T -spectrum

$$Z^K = \mathbf{Hom}_*(K, Z)$$

is defined in levels by

$$\mathbf{Hom}_*(K, Z)^n = \mathbf{Hom}_*(K, Z^n),$$

where \mathbf{Hom}_* denotes the pointed internal hom functor, as in Section 1.1. The structure map

$$T^p \wedge \mathbf{Hom}_*(K, Z^n) \xrightarrow{\sigma} \mathbf{Hom}_*(K, Z^{p+n})$$

is the unique pointed simplicial set map making the diagram

$$\begin{array}{ccc} T^p \wedge \mathbf{Hom}_*(K, Z^n) \wedge K & \xrightarrow{\sigma \wedge K} & \mathbf{Hom}_*(K, Z^{p+n}) \wedge K \\ T^p \wedge \text{ev} \downarrow & & \downarrow \text{ev} \\ T^p \wedge Z^n & \xrightarrow{\sigma} & Z^{p+n} \end{array}$$

commute, where ev is the evaluation map wherever it appears. This construction is natural in K and Z , and there are natural isomorphisms

$$\mathbf{Hom}_*(K \wedge L, Z) \cong \mathbf{Hom}_*(K, \mathbf{Hom}_*(L, Z))$$

for all pointed simplicial presheaves K, L , and symmetric T -spectra Z .

We shall write $\Omega_T X$ for the symmetric T -spectrum $\mathbf{Hom}_*(T, X)$, in order to simplify notation.

Following [13], define a natural *shift functor* $Z \mapsto Z[1]$ for symmetric T -spectra Z by setting $Z[1]^m = Z^{1+m}$, where $\sigma \in \Sigma_m$ acts on $Z[1]^m$ as $1 \oplus \sigma \in \Sigma_{m+1}$. The structure map $\sigma_* : T^p \wedge Z[1]^m \rightarrow Z[1]^{p+m}$ is defined to be the composite

$$T^p \wedge Z^{1+m} \xrightarrow{\sigma} Z^{p+1+m} \xrightarrow{c(p,1) \oplus 1} Z^{1+p+m},$$

where $c(p, 1) \in \Sigma_{p+1}$ is the cyclic permutation of order $p + 1$. One checks that σ_* is $\Sigma_p \times \Sigma_m$ -equivariant. Define the shifted symmetric T -spectrum $Z[s]$ inductively by $Z[s] = Z[s - 1][1]$, or directly.

The standard maps $\sigma_* : Z^n \rightarrow \mathbf{Hom}_*(T, Z^{1+n})$ which are adjoint to the composites

$$Z^n \wedge T \xrightarrow{t} T \wedge Z^n \xrightarrow{\sigma} Z^{1+n}$$

together determine a natural map of symmetric T -spectra

$$\sigma_* : Z \rightarrow \mathbf{Hom}_*(T, Z[1]) \cong \mathbf{Hom}_*(T, Z)[1],$$

or equivalently a map

$$\sigma_* : Z \rightarrow \Omega_T(Z[1]) \cong (\Omega_T Z)[1]. \tag{4.1}$$

Suppose that Z is a symmetric T -spectrum which is level fibrant. Flipping loop factors defines a natural isomorphism

$$t^* : \Omega_T^2 Z[2] \rightarrow \Omega_T^2 Z[2],$$

and there is an isomorphism $(1, 2) : Z[2] \rightarrow Z[2]$ which consists of maps $(1, 2) : Z^{2+n} \rightarrow Z^{2+n}$ induced by the transposition $(1, 2) \in \Sigma_{2+n}$. Write $\tilde{\sigma}$ for the bonding maps of $\Omega_T Z[1]$. Then there is a natural commutative diagram

$$\begin{array}{ccc} \Omega_T Z[1] & \xrightarrow{\Omega_T \sigma_*[1]} & \Omega_T^2 Z[2] \\ & \searrow \tilde{\sigma}_* & \downarrow (1,2)_* t^* \\ & & \Omega_T^2 Z[2] \end{array}$$

which translates into a diagram of simplicial presheaves

$$\begin{array}{ccc} \Omega_T Z^{n+1} & \xrightarrow{\Omega_T \sigma_*} & \Omega_T^2 Z^{n+2} \\ & \searrow \tilde{\sigma}_* & \downarrow (1,2)_* t^* \\ & & \Omega_T^2 Z^{n+2} \end{array} \tag{4.2}$$

for each n .

For a level fibrant object Z , define the symmetric T -spectrum $Q_T^\Sigma Z$ to be the filtered colimit of the system

$$Z \xrightarrow{\sigma_*} \Omega_T Z[1] \xrightarrow{\tilde{\sigma}_*} \Omega_T^2 Z[2] \xrightarrow{\tilde{\sigma}_*} \dots \tag{4.3}$$

LEMMA 4.7. *Suppose that Z is a level fibrant symmetric T -spectrum. Then there is a natural isomorphism*

$$Q_T^\Sigma Z^n \cong Q_T(UZ)^n.$$

WARNING: Lemma 4.7 only says that the T -spectra $U(Q_T^\Sigma Z)$ and $Q_T(UZ)$ are isomorphic in each level. The assertion that these are isomorphic spectrum objects is one of the canonical mistakes in the theory of symmetric spectra.

Proof of Lemma 4.7. To extend the notation for the bonding map $\tilde{\sigma}$ of $\Omega_T Z[1]$ given above, write

$$\sigma_*^{\sim(n)} = \widetilde{\sigma_*^{\sim(n-1)}} : \Omega_T^n Z[n] \rightarrow \Omega_T^{n+1} Z[n+1],$$

so that $\tilde{\sigma}_* = \sigma_*^{\sim(1)}$ and $\tilde{\tilde{\sigma}}_* = \sigma_*^{\sim(2)}$ in the sequence (4.3). Repeated instances of the diagram (4.2) paste together to give a natural commutative diagram

$$\begin{array}{ccc} \Omega_T^k Z^{n+k} & \xrightarrow{\sigma_*^{\sim(k)}} & \Omega_T^{k+1} Z^{n+k+1} \\ & \searrow \Omega_T^k \sigma_* & \downarrow \theta_{k+1} \\ & & \Omega_T^{k+1} Z^{n+k+1} \end{array}$$

where θ_{k+1} is a composite of isomorphisms $\Omega_T^i t^*$ or $(1, 2)_*$.

Now suppose given natural isomorphisms $\gamma_i : \Omega_T^i Z^{n+i} \rightarrow \Omega_T^i Z^{n+i}$ such that the diagram

$$\begin{array}{ccccccc} \Omega_T Z^{n+1} & \xrightarrow{\sigma_*^{\sim(1)}} & \Omega_T^2 Z^{n+2} & \xrightarrow{\sigma_*^{\sim(2)}} & \dots & \xrightarrow{\sigma_*^{\sim(k-1)}} & \Omega_T^k Z^{n+k} \\ \downarrow 1 & & \downarrow \gamma_2 & & & & \downarrow \gamma_k \\ \Omega_T Z^{n+1} & \xrightarrow{\Omega_T \sigma_*} & \Omega_T^2 Z^{n+2} & \xrightarrow{\Omega_T^2 \sigma_*} & \dots & \xrightarrow{\Omega_T^{k-1} \sigma_*} & \Omega_T^k Z^{n+k} \end{array}$$

commutes, and all isomorphisms γ_i are compositions of $\Omega_T^j t^*$ or $(i, i+1)_*$. In particular, presume that $\gamma_2 = t^*(1, 2)_* : \Omega_T^2 Z^{n+2} \rightarrow \Omega_T^2 Z^{n+2}$. Then the isomorphism $\Omega_T^j t^*$ commutes with $\Omega_T^k \sigma_* : \Omega_T^k Z^{n+k} \rightarrow \Omega_T^{k+1} Z^{n+k+1}$, and

$$\sigma_*(i, i+1)_* = (i+1, i+2)_* \sigma_*$$

so there is an isomorphism $\bar{\gamma}_{k+1}$ composed of maps $\Omega_T^j t^*$ and $(i, i+1)_*$ such that the diagram

$$\begin{array}{ccc} \Omega_T^k Z^{n+k} & \xrightarrow{\sigma_*^{\sim(k)}} & \Omega_T^{k+1} Z^{n+k+1} \\ \downarrow \gamma_k & \searrow \Omega_T^k \sigma_* & \downarrow \theta_{k+1} \\ & & \Omega_T^{k+1} Z^{n+k+1} \\ & & \downarrow \bar{\gamma}_{k+1} \\ \Omega_T^k Z^{n+k} & \xrightarrow{\Omega_T^k \sigma_*} & \Omega_T^{k+1} Z^{n+k+1} \end{array}$$

commutes. The natural isomorphism γ_{k+1} is defined by $\gamma_{k+1} = \bar{\gamma}_{k+1} \theta_{k+1}$. \square

Formally, there is a map $c : Q_T^\Sigma X \wedge K \rightarrow Q_T^\Sigma(X \wedge K)$ which fits into a natural commutative diagram

$$\begin{array}{ccc} Q_T^\Sigma X \wedge K & \xrightarrow{c} & Q_T^\Sigma(X \wedge K), \\ \uparrow \gamma_{X \wedge K} & \nearrow \gamma_{X \wedge K} & \\ X \wedge K & & \end{array}$$

for all symmetric T -spectra X and pointed simplicial sets K . It follows that the functor Q_T^Σ prolongs to a simplicial functor

$$Q_T^\Sigma : \mathbf{hom}(X, Y) \rightarrow \mathbf{hom}(Q_T^\Sigma X, Q_T^\Sigma Y).$$

PROPOSITION 4.8. *Suppose that $\alpha : X \rightarrow Y$ is a map of symmetric T -spectra such that $U\alpha : UX \rightarrow UY$ is a stable equivalence of T -spectra. Then α is a stable equivalence of symmetric T -spectra.*

Proof. We can assume that X and Y are level fibrant. If W is a stably fibrant and injective object, then the canonical map $\gamma_W : W \rightarrow Q_T^\Sigma W$ is a level equivalence, and hence induces a weak equivalence

$$\gamma_W^* : \mathbf{hom}(Q_T^\Sigma W, W) \rightarrow \mathbf{hom}(W, W).$$

It follows that there is a map $g_W : Q_T^\Sigma W \rightarrow W$ such that the composite $g_W \gamma_W$ is simplicially homotopic to the identity 1_W on W .

The composite

$$\mathbf{hom}(X, W) \xrightarrow{Q_T^\Sigma} \mathbf{hom}(Q_T^\Sigma X, Q_T^\Sigma W) \xrightarrow{g_W^*} \mathbf{hom}(Q_T^\Sigma X, W) \xrightarrow{\gamma_X^*} \mathbf{hom}(X, W)$$

is induced by composition with $g_W \gamma_W$, and is therefore homotopic to the identity on $\mathbf{hom}(X, W)$. The composition and the homotopy are natural in X . If $\alpha : X \rightarrow Y$ induces a stable equivalence $U\alpha : UX \rightarrow UY$, then the induced map $Q_T^\Sigma \alpha : Q_T^\Sigma X \rightarrow Q_T^\Sigma Y$ is a level equivalence by Lemma 4.7, and so the maps

$$Q_T^\Sigma \alpha^* : \mathbf{hom}(Q_T^\Sigma Y, W) \rightarrow \mathbf{hom}(Q_T^\Sigma X, W)$$

and hence the morphisms

$$\alpha^* : \mathbf{hom}(Y, W) \rightarrow \mathbf{hom}(X, W)$$

are weak equivalences of pointed simplicial sets. □

Recall that if Y is a symmetric T -spectrum and $n \geq 0$, then the shift $Y[n]$ is defined by $Y[n]^p = Y^{n+p}$, with $\alpha \in \Sigma_p$ acting as $1_n \oplus \alpha$. The bonding map $T^q \wedge Y[n]^p \rightarrow Y[n]^{q+p}$ for $Y[n]$ is the composite

$$T^q \wedge Y^{n+p} \xrightarrow{\sigma} Y^{q+n+p} \xrightarrow{c_{q,n} \oplus 1} Y^{n+q+p}$$

where σ is the original bonding map for Y .

Suppose that X is a symmetric T -spectrum, with T -module structure map $\sigma : T \otimes X \rightarrow X$. Then the symmetric sequence $G_n(S^0) \otimes X$ has a symmetric T -spectrum structure, with T -structure given by the composite

$$T \otimes G_n(S^0) \otimes X \xrightarrow{\tau \otimes 1} G_n(S^0) \otimes T \otimes X \xrightarrow{1 \otimes \sigma} G_n(S^0) \otimes X.$$

A symmetric T -spectrum map $f : G_n(S^0) \otimes X \rightarrow Y$ consists of pointed simplicial presheaf maps $f : X^p \rightarrow Y^{n+p}$ which are equivariant for the homomorphisms $\Sigma_p \rightarrow \Sigma_{n+p}$ defined by $\alpha \mapsto 1_n \oplus \alpha$, and such that the diagrams

$$\begin{array}{ccc} T^q \wedge X^p & \xrightarrow{1 \wedge f} & T^q \wedge Y^{n+p} \\ \sigma \downarrow & & \downarrow \sigma \\ & & Y^{q+n+p} \\ & & \downarrow c_{q,n} \oplus 1 \\ X^{q+p} & \xrightarrow{f} & Y^{n+q+p} \end{array}$$

commute. It follows that the symmetric T -spectrum map $f : G_n(S^0) \otimes X \rightarrow Y$ can be identified with a symmetric T -spectrum map $X \rightarrow Y[n]$, and we have proved

LEMMA 4.9. *The functor $X \mapsto G_n(S^0) \otimes X$ is left adjoint to the shift functor $Y \mapsto Y[n]$ for $n \geq 0$.*

The functor $X \mapsto G_n(S^0) \otimes X$ preserves level cofibrations and level equivalences, so we have

COROLLARY 4.10. *The shift functor $Y \mapsto Y[n]$ preserves injective fibrations and level trivial injective fibrations. In particular, if Y is an injective symmetric T -spectrum, then $Y[n]$ is an injective symmetric T -spectrum for $n \geq 0$.*

LEMMA 4.11. *Suppose that the commutative diagram*

$$\begin{array}{ccccc} A_1 & \xrightarrow{i_1} & B_1 & \xrightarrow{\pi_1} & B_1/A_1 \\ f_1 \downarrow & & \downarrow f_2 & & \downarrow f_3 \\ A_2 & \xrightarrow{i_2} & B_2 & \xrightarrow{\pi_2} & B_2/A_2 \end{array}$$

is a comparison diagram of level cofibre sequences. Then if any two of the maps f_1, f_2 and f_3 are stable equivalences of symmetric T -spectra, then so is the third.

Proof. We shall show that f_1 is a stable equivalence if f_2 and f_3 are stable equivalences. This amounts to showing that the map f_1^* in the comparison diagram of fibrations

$$\begin{array}{ccccc}
 \mathbf{hom}(B_2/A_2, W) & \xrightarrow{\pi_2^*} & \mathbf{hom}(B_2, W) & \xrightarrow{i_2^*} & \mathbf{hom}(A_2, W) \\
 f_3^* \downarrow & & \downarrow f_2^* & & \downarrow f_1^* \\
 \mathbf{hom}(B_1/A_1, W) & \xrightarrow{\pi_1^*} & \mathbf{hom}(B_1, W) & \xrightarrow{i_1^*} & \mathbf{hom}(A_1, W)
 \end{array}$$

is a weak equivalence for any choice of stably fibrant injective object W , in the presence of knowing that the simplicial set maps f_2^* and f_3^* are weak equivalences.

There is a levelwise equivalence

$$W \rightarrow \Omega_T W[1] \simeq \Omega_{\mathbb{G}_m} W[1],$$

of stably fibrant injective objects, where $W[1]$ is injective by Corollary 4.10. It is also the case that $\Omega_{\mathbb{G}_m} W[1]$ is stably fibrant and injective. It follows that the comparison diagram of fibrations can be delooped infinitely often. In particular, f_1^* is part of a stable weak equivalence of infinite loop spaces, and is therefore a weak equivalence of simplicial sets. \square

COROLLARY 4.12. *Suppose that the commutative diagram*

$$\begin{array}{ccccc}
 F_1 & \longrightarrow & X_1 & \xrightarrow{p_1} & Y_1 \\
 f_1 \downarrow & & \downarrow f_2 & & \downarrow f_3 \\
 F_2 & \longrightarrow & X_2 & \xrightarrow{p_2} & Y_2
 \end{array}$$

is a comparison diagram of level fibre sequences of symmetric T -spectra. Then if any two of f_1, f_2 and f_3 are stable equivalences, then so is the third.

Proof. Use Lemma 3.9 to replace the comparison of fibre sequences by the a comparison of level cofibre sequences

$$F_i \xrightarrow{i} X_i \xrightarrow{\pi} X_i/F_i. \tag{4.4}$$

More precisely, Lemma 3.9 guarantees that the map of T -spectra underlying $p_{i*} : X_i/F_i \rightarrow Y_i$ is a stable equivalence, so that p_{i*} is a stable equivalence of symmetric T -spectra by Proposition 4.8. Now use Lemma 4.11. \square

We are now ready to prove the following:

PROPOSITION 4.13. *Suppose that $p : X \rightarrow Y$ is a map of symmetric T -spectra which is both a stable fibration and a stable equivalence. Then p is a level equivalence.*

Proof. It suffices to show that the fibre F of p is level contractible. If so, the underlying map Up of T -spectra is a stable fibration and a stable equivalence by a long exact sequence argument in bigraded stable homotopy groups (3.2), and is therefore a level equivalence.

The comparison map

$$\begin{array}{ccccc} F & \longrightarrow & X & \xrightarrow{p} & Y \\ \downarrow & & \downarrow \simeq & & \downarrow 1 \\ * & \longrightarrow & Y & \xrightarrow{1} & Y \end{array}$$

of level fibre sequences and Corollary 4.12 together imply that the map $F \rightarrow *$ is a stable equivalence of stably fibrant objects, so it is a level weak equivalence by Corollary 4.6. \square

COROLLARY 4.14. *A map $p : X \rightarrow Y$ of symmetric T -spectra is a stable fibration and a stable equivalence if and only if it is both a level fibration and a level equivalence.*

Proof. One direction is Proposition 4.13; the other follows from the definition of stable equivalence of symmetric T -spectra and Lemma 2.7. \square

Say that a map $i : A \rightarrow B$ of symmetric T -spectra is a *stable cofibration* if it has the left lifting property with respect to all morphisms $p : X \rightarrow Y$ which are simultaneously stable fibrations and stable equivalences. In view of Corollary 4.14, the maps

$$F_n(A_+) \rightarrow F_n(L_U \Delta_+^r)$$

induced by the inclusions $A \subset L_U \Delta^r$ are stable cofibrations for all r and objects U . Here, L_U denotes the left adjoint to the U -sections functor for simplicial presheaves.

THEOREM 4.15. *The category $\mathbf{Spt}_T^\Sigma(\mathit{Sm}|_S)_{\mathit{Nis}}$ of symmetric T -spectra on the smooth Nisnevich site, and the classes of stable equivalences, stable fibrations and stable cofibrations, together satisfy the axioms for a proper closed simplicial model category.*

Proof. On account of Proposition 4.4, every map $g : X \rightarrow Y$ of symmetric T -spectra has a factorization

$$\begin{array}{ccc} X & \xrightarrow{j} & Z \\ & \searrow g & \downarrow p \\ & & Y \end{array} \quad (4.5)$$

such that p is a stable fibration, and j has the left lifting property with respect to all stable fibrations and induces trivial fibrations $j^* : \mathbf{hom}(Z, W) \rightarrow$

$\mathbf{hom}(X, W)$ for all stably fibrant objects W . In particular, j is a stable equivalence and a stable cofibration. The map j is a level cofibration, by Lemma 4.3.

A transfinite small object argument says that $g : X \rightarrow Y$ has a factorization

$$\begin{array}{ccc} X & \xrightarrow{i} & U \\ & \searrow g & \downarrow q \\ & & Y \end{array}$$

such that i has the left lifting property with respect to all maps which are simultaneously level fibrations and level weak equivalences, and q has the right lifting property with respect to all morphisms $F_n(A_+) \rightarrow F_n(L_U \Delta_+^r)$ corresponding to cofibrations $A \hookrightarrow L_U \Delta^n$ of simplicial presheaves for all n and objects $U \in \mathcal{C}$. In particular, q is a level trivial fibration and hence a stable fibration as well as a stable equivalence by Corollary 4.14. The map i has the left lifting property with respect to all maps which are stable fibrations and stable equivalences, also by Corollary 4.14, so that i is a stable cofibration. It is a consequence of the small object argument that the map i is a level cofibration.

The factorization axiom CM5 has therefore been demonstrated. The existence of the factorization (4.5) implies that every map which is a stable cofibration and a stable equivalence has the left lifting property with respect to all stable fibrations and is a level cofibration, by a standard argument. We have proved CM4, and the axioms CM1 – CM3 are obvious.

If $i : K \hookrightarrow L$ is an inclusion of simplicial sets and $p : X \rightarrow Y$ is a stable fibration of symmetric T -spectra, then the induced map

$$(i^*, p_*) : \mathbf{hom}_*(L_+, X) \rightarrow \mathbf{hom}_*(K_+, X) \times_{\mathbf{hom}_*(K_+, Y)} \mathbf{hom}_*(L_+, Y)$$

is a stable fibration, which is trivial if i is a weak equivalence or p is a stable equivalence. This is on account of the corresponding statement for T -spectra and Corollary 4.14, and implies the axiom SM7 for $\mathbf{Spt}_T^{\Sigma}(Sm|_S)_{Nis}$.

The properness assertion is a consequence of Lemma 4.11 and Corollary 4.12. \square

4.3 THE SMASH PRODUCT

The *smash product* $X \wedge Y$ of the symmetric T -spectra X and Y is defined by the symmetric sequence coequalizer

$$T \otimes X \otimes Y \rightrightarrows X \otimes Y \rightarrow X \wedge Y$$

of the map $m \otimes 1 : T \otimes X \otimes Y \rightarrow X \otimes Y$ with the composite

$$T \otimes X \otimes Y \xrightarrow{\tau \otimes 1} X \otimes T \otimes Y \xrightarrow{1 \otimes m} X \otimes Y$$

where m denotes the T -module structure for each of X and Y . The T -module structure on $X \wedge Y$ is induced by the map $m \otimes 1 : T \otimes X \otimes Y \rightarrow X \otimes Y$.

The smash product gives the category $\mathbf{Spt}_T^\Sigma(Sm|_S)_{Nis}$ of symmetric T -spectra the structure of a symmetric monoidal category. This is a formal consequence of the fact that the symmetric T -spectrum T is a commutative monoid in the category of symmetric sequences, just as in [7].

A map $h : X \wedge Y \rightarrow Z$ of symmetric T -spectra can be characterized as a collection of $(\Sigma_p \times \Sigma_q)$ -equivariant maps $h_{p,q} : X^p \wedge Y^q \rightarrow Z^{p+q}$, $p, q \geq 0$, which are T -linear in the sense that the diagram

$$\begin{array}{ccc}
 T^r \wedge X^p \wedge Y^q & \xrightarrow{\sigma \wedge 1} & X^{r+p} \wedge Y^q \\
 1 \wedge h_{p,q} \downarrow & & \downarrow h_{r+p,q} \\
 T^r \wedge Z^{p+q} & \xrightarrow{\sigma} & Z^{r+p+q}
 \end{array} \tag{4.6}$$

commutes, and are T -bilinear, meaning that the following diagram commutes

$$\begin{array}{ccccc}
 T^r \wedge X^p \wedge Y^q & \xrightarrow{t \wedge 1} & X^p \wedge T^r \wedge Y^q & \xrightarrow{1 \wedge \sigma} & X^p \wedge Y^{r+q} \\
 \sigma \wedge 1 \downarrow & & & & \downarrow h_{p,r+q} \\
 X^{r+p} \wedge Y^q & \xrightarrow{h_{r+p,q}} & Z^{r+p+q} & \xrightarrow{c_{r,p} \oplus 1} & Z^{p+r+q}
 \end{array} \tag{4.7}$$

for each $p, q, r \geq 0$.

LEMMA 4.16. *There is a natural isomorphism*

$$\text{hom}(F_n(S^0) \wedge A, X) \cong \text{hom}(A, X[n])$$

for symmetric T -spectra A and X .

Proof. Recall that the symmetric T -spectrum $F_n(S^0) \cong T \otimes G_n(S^0)$ has the form

$$F_n(S^0)_j = \begin{cases} * & j < n \\ \Sigma_j \otimes_{\Sigma_{j-n} \times \Sigma_n} (T^{j-n} \wedge \Sigma_{n+}) & j \geq n \end{cases}$$

and has the obvious T -action. Here, Σ_{n+} denotes the set $\Sigma_n \sqcup \{*\}$, pointed by the terminal object $*$.

A map $h : F_n(S^0) \wedge X \rightarrow Y$ is therefore determined by $(\Sigma_p \times \Sigma_n \times \Sigma_q)$ -equivariant maps $h_{p+n,q} : T^p \wedge \Sigma_{n+} \wedge X^q \rightarrow Y^{n+p+q}$ for $p, q \geq 0$, which satisfy compatibility conditions given by diagrams (4.6) and (4.7) above. In particular the maps

$$h_{n,q} : \Sigma_{n+} \wedge X^q \rightarrow Y^{n+q}$$

are completely determined by the Σ_q -equivariant composites

$$X^q \xrightarrow{in_e} \Sigma_{n+} \wedge X^q \xrightarrow{h_{n,q}} Y^{n+q},$$

where $\sigma \in \Sigma_q$ acts on Y^{n+q} via $1_n \oplus \sigma$ and in_e is the inclusion of the wedge summand corresponding to the identity element $e \in \Sigma_n$. Then the Σ_q -equivariant maps

$$h_q = h_{n,q} in_e : X^q \rightarrow Y^{n+q}$$

define a map of symmetric T -spectra $h_* : X \rightarrow Y[n]$ — seeing this is a matter of chasing the definitions through instances of the diagrams (4.6) and (4.7).

For the converse, suppose given a map $h : X \rightarrow Y[n]$ of symmetric T -spectra, which is defined by Σ_q -equivariant maps $h_q : X^q \rightarrow Y^{n+q}$. Then h_q uniquely extends to a $(\Sigma_n \times \Sigma_q)$ -equivariant map $h_{n,q} : \Sigma_{n+} \wedge X^q \rightarrow Y^{n+q}$. Define the map $h_{p+n,q} : T^p \wedge \Sigma_{n+} \wedge X^q \rightarrow Y^{p+n+q}$ to be the composite

$$T^p \wedge \Sigma_{n+} \wedge X^q \xrightarrow{1 \wedge h_{n,q}} T^p \wedge Y^{n+q} \xrightarrow{\sigma} Y^{p+n+q}.$$

This description of the maps $h_{n,q}$ is determined by h and the T -linearity requirement. For the T -bilinearity, it suffices to show that the diagram

$$\begin{array}{ccc} T^p \wedge \Sigma_{n+} \wedge X^q & \xrightarrow{1 \wedge 1} & \Sigma_{n+} \wedge T^p \wedge X^q \\ \downarrow 1 \wedge h_{n,q} & & \downarrow 1 \wedge \sigma \\ T^p \wedge Y^{n+q} & & \Sigma_{n+} \wedge X^{p+q} \\ \downarrow \sigma & & \downarrow h_{n,p+q} \\ Y^{p+n+q} & \xrightarrow{c_{p,n} \oplus 1} & Y^{n+p+q} \end{array}$$

commutes, but this follows from the commutativity of the diagram

$$\begin{array}{ccc} T^p \wedge X^q & \xrightarrow{1 \wedge h_q} & T^p \wedge Y^{n+q} \\ \downarrow \sigma & & \downarrow \sigma \\ X^{p+q} & \xrightarrow{h_{p+q}} & Y^{n+p+q} \end{array}$$

Y^{p+n+q} is positioned between the two columns, with a vertical arrow $c_{p,n} \oplus 1$ pointing from Y^{p+n+q} down to Y^{n+p+q} .

that arises from the symmetric T -spectrum map $h : X \rightarrow Y[n]$. □

COROLLARY 4.17. *There is a natural isomorphism of symmetric T -spectra*

$$F_n(S^0) \wedge X \cong G_n(S^0) \otimes X.$$

Proof. Both functors are left adjoint to the shift functor $X \mapsto X[n]$ — see Lemma 4.9. \square

COROLLARY 4.18. *There are isomorphisms*

$$F_n(A) \wedge F_m(B) \cong F_{n+m}(A \wedge B),$$

and these isomorphisms are natural in pointed simplicial presheaves A and B .

PROPOSITION 4.19. *Suppose that $i : A \rightarrow B$ is a stable cofibration and that $j : C \rightarrow D$ is a level cofibration. Then the map*

$$(i, j)_* : (B \wedge C) \cup_{(A \wedge C)} (A \wedge D) \rightarrow B \wedge D$$

is a level cofibration. If i and j are both cofibrations, then $(i, j)_$ is a cofibration. If either i or j is a stable equivalence, then $(i, j)_*$ is a stable equivalence.*

Proof. We shall begin with the statements on stable cofibrations. The map (i_*, j_*) induced by the cofibrations $i_* : F_n(A) \rightarrow F_n(B)$ and $j_* : F_m(C) \rightarrow F_m(D)$ is isomorphic to the map obtained from the pointed simplicial set cofibration

$$(B \wedge C) \cup_{(A \wedge C)} (A \wedge D) \rightarrow B \wedge D$$

by applying the functor F_{n+m} , so (i_*, j_*) is a cofibration.

Suppose that we fix a choice of cofibration $j : C \rightarrow D$. Then the collection of level cofibrations $i : A \rightarrow B$ for which the map (i, j) is a cofibration (respectively a trivial cofibration) is saturated; this means that the collection is closed under pushouts, filtered colimits over ordinals, and retracts. It follows that all maps of the form (i, j_*) and hence all maps (i, j) are cofibrations, for all cofibrations i , and then for all cofibrations j .

The cofibre of the cofibration (i, j) is $B/A \wedge D/C$, and both factors are cofibrant. To show that $(i, j)_*$ is a trivial cofibration if either i or j is a stable equivalence, it suffices to show that, given cofibrant objects A and B , the symmetric T -spectrum $A \wedge B$ is trivially cofibrant if either A or B is trivially cofibrant. For this, it is enough to show that the map $1 \wedge i_* : A \wedge F_n(K) \rightarrow A \wedge F_n(L)$ is a trivial cofibration if A is trivially cofibrant and $i : K \rightarrow L$ is a cofibration of pointed simplicial presheaves.

We have natural isomorphisms

$$F_n(K) \cong F_n(S^0) \wedge K$$

and we also know from Lemma 4.16 that there is an isomorphism

$$\mathrm{hom}(A \wedge F_n(S^0), X) \cong \mathrm{hom}(A, X[n]) \tag{4.8}$$

It follows that the diagram

$$\begin{array}{ccc}
 A \wedge F_n(K) & \longrightarrow & X \\
 1 \wedge i_* \downarrow & \nearrow & \downarrow p \\
 A \wedge F_n(L) & \longrightarrow & Y
 \end{array}$$

is adjoint to a diagram

$$\begin{array}{ccc}
 & & X^L[n] \\
 & \nearrow & \downarrow \\
 A & \longrightarrow & X^K[n] \times_{Y^K[n]} Y^L[n]
 \end{array}$$

and the dotted arrow exists by axiom SM7 and the fact that stable fibrations shift in the category of T -spectra. In particular, $1 \wedge i_*$ is a trivial cofibration.

Suppose more generally that i is a stable cofibration and that j is a level cofibration. To show that $(i, j)_*$ is a level cofibration, it suffices by a saturation argument to show that the map

$$(F_n(L) \wedge C) \cup_{(F_n(K) \wedge C)} (F_n(K) \wedge D) \rightarrow F_n(L) \wedge D$$

is a level cofibration for all cofibrations $K \rightarrow L$ of pointed simplicial presheaves. This amounts to showing that the dotted arrow exists in all diagrams

$$\begin{array}{ccc}
 C & \longrightarrow & X^L[n] \\
 j \downarrow & \nearrow & \downarrow \\
 D & \longrightarrow & (Y^L \times_{Y^K} X^K)[n]
 \end{array}$$

arising from all trivial injective fibrations p , but this is a consequence of the Corollary 4.10 and the properness property for the level model structure on symmetric T -spectra (Theorem 4.2).

The same argument implies that any trivial level cofibration $j : C \rightarrow D$ induces a trivial level cofibration $(i, j)_*$ for any stable cofibration i . It follows that a level weak equivalence $f : E \rightarrow F$ induces a level weak equivalence $1 \wedge f : A \wedge E \rightarrow A \wedge F$ for any cofibrant symmetric T -spectrum A .

The map $(i, j)_*$ is a level cofibration with cofibre $B/A \wedge D/C$, where B/A is cofibrant. To show that $(i, j)_*$ is stably trivial if either i or j is stably trivial, it suffices once again to show that if B is cofibrant, then $A \wedge B$ is stably equivalent to a point if this is so for either A or B . But there is a level weak equivalence $\bar{A} \rightarrow A$ where \bar{A} is cofibrant by Corollary 4.14 and Theorem 4.15, and the induced map $\bar{A} \wedge B \rightarrow A \wedge B$ is a level equivalence by the argument above. The result is therefore a consequence of the cofibration case. \square

Write $\mathbf{Map}_\Sigma(X, Y)$ for the *mapping symmetric T -spectrum* object associated to symmetric T -spectra X and Y . This object exists formally in the category of symmetric T -spectra, just as in [7, Lemma 2.2.2]. In particular, there are natural adjunction isomorphisms

$$\mathbf{hom}(Z \wedge X, Y) \cong \mathbf{hom}(Z, \mathbf{Map}_\Sigma(X, Y))$$

Every symmetric T -spectrum X functorially determines a symmetric T -spectrum object $X[*]$ in the category of symmetric T -spectra, with objects $X[n]$, $n \geq 0$ and having bonding maps $T^p \wedge X[n] \rightarrow X[p+n]$. Each $X[n]$ carries a canonical Σ_n -action, and the maps $\sigma : T^p \wedge X[n] \rightarrow X[p+n]$ are $(\Sigma_p \times \Sigma_n)$ -equivariant. The map σ is defined in level r by the bonding map $T^p \wedge X^{n+r} \rightarrow X^{p+n+r}$ of the original symmetric T -spectrum X .

The point of the remainder of this section is to characterize the levels $\mathbf{Map}_\Sigma(X, Y)^n$ in terms of the internal function spaces $\mathbf{Hom}(X, Y[n])$ arising from shifts of Y .

Write $\alpha : F_{n+p}(S^0) \wedge T^p \rightarrow F_n(S^0)$ for the map of symmetric T -spectra which picks out the copy of T^p corresponding to the identity $e \in \Sigma_n$ in

$$T^p \wedge \Sigma_{n+} \subset F_n(S^0)^{n+p}.$$

Then $\mathbf{Hom}(F_n(S^0), X) \cong X^n$ and precomposition with the map α induces the adjoint $X^n \rightarrow \Omega_T^p X^{n+p}$ of the bonding map $T^p \wedge X^n \rightarrow X^{n+p}$.

It follows that there are isomorphisms

$$\begin{aligned} \mathbf{Map}_\Sigma(X, Y)^n &= \mathbf{Hom}(F_n(S^0), \mathbf{Map}_\Sigma(X, Y)) \\ &\cong \mathbf{Hom}(F_n(S^0) \wedge X, Y) \\ &\cong \mathbf{Hom}(X, Y[n]) \end{aligned}$$

by Lemma 4.16. One sees further that the adjoint bonding map

$$\mathbf{Map}_\Sigma(X, Y)^n \xrightarrow{\sigma^*} \Omega_T^p \mathbf{Map}_\Sigma(X, Y)^{n+p}$$

is determined by precomposition with α .

There is a commutative diagram

$$\begin{array}{ccc} \mathbf{hom}(F_n(S^0) \wedge X, Y) & \xrightarrow{\cong} & \mathbf{hom}(X, Y[n]) \\ \alpha^* \downarrow & & \downarrow \sigma^* \\ \mathbf{hom}(F_{n+p}(S^0) \wedge T^p \wedge X, Y) & \xrightarrow[\cong]{} & \mathbf{hom}(X, \Omega_T^p Y[n+p]) \end{array}$$

involving canonical isomorphisms and the adjoint $Y[n] \rightarrow \Omega_T^p Y[n+p]$ of the map $\sigma : T^p \wedge Y[n] \rightarrow Y[n+p]$. This, in turn, is a consequence of the commu-

tativity of the diagram

$$\begin{array}{ccc}
 F_{n+p}(S^0) \wedge T^p \wedge Y[n] & \xrightarrow{\alpha \wedge 1} & F_n(S^0) \wedge Y[n] \\
 1 \wedge \sigma \downarrow & & \downarrow ev_n \\
 F_{n+p}(S^0) \wedge Y[n+p] & \xrightarrow{ev_{n+p}} & Y
 \end{array}$$

where $ev_n : F_n(S^0) \wedge Y[n] \rightarrow Y$ is adjoint to the identity map $Y[n] \rightarrow Y[n]$. One uses the concrete description of ev_n given by proof of the Lemma 4.16 to show that this diagram commutes.

We have shown the following:

PROPOSITION 4.20. *There is a natural isomorphism*

$$\mathbf{Map}_\Sigma(X, Y)^n \cong \mathbf{Hom}(X, Y[n]),$$

and the bonding maps of $\mathbf{Map}_\Sigma(X, Y)$ are induced by composition with the adjoints $Y[n] \rightarrow \Omega_T^p Y[p+n]$ of the maps $\sigma : T^p \wedge Y[n] \rightarrow Y[p+n]$

4.4 EQUIVALENCE OF STABLE CATEGORIES

The purpose of this section is to show that the stable closed model structure on the category $\mathbf{Spt}_T^\Sigma(Sm|_S)_{Nis}$ of symmetric T -spectra has associated homotopy category equivalent to the motivic stable category arising from the category $\mathbf{Spt}_T(Sm|_S)_{Nis}$ of T -spectra.

The equivalence of homotopy categories is induced by the functors U (which forgets the symmetry) and its left adjoint V . As in [7] and [13], the proof of the equivalence of homotopy categories boils down to showing that any stably fibrant model $j : VX \rightarrow (VX)_s$ associated to a cofibrant T -spectrum X induces a stable equivalence given by the composite

$$X \xrightarrow{\eta} UVX \xrightarrow{Uj} U(VX)_s.$$

The idea of proof is to use a layer filtration for X , and then show that the result for all of the layers implies the statement for X .

The functor V preserves stably trivial cofibrations and level equivalences, and hence preserves stable equivalences. It follows that the functor $X \mapsto U(VX)_s$ preserves stable equivalences. Each of the layers of X is a shifted suspension object up to stable equivalence, so we inductively prove the claim for shifted suspensions, beginning with suspension T -spectra $\Sigma_T^\infty K$ associated to pointed simplicial presheaves K .

The canonical map $\eta : \Sigma_T^\infty K \rightarrow UV(\Sigma_T^\infty K)$ is an isomorphism, so it suffices to find a stably fibrant model

$$V(\Sigma_T^\infty K) \cong T \otimes K \xrightarrow{j} (T \otimes K)_s$$

for the symmetric T -spectrum $T \otimes K$ such that the map j induces a stable equivalence $Uj : U(T \otimes K) \rightarrow U(T \otimes K)_s$ of T -spectra — this is Lemma 4.23 below.

The construction that we use involves T -bispectra. A T -bispectrum X consists of pointed simplicial presheaves $X^{r,s}$, $r, s \geq 0$, together with bonding maps

$$\sigma_h : T \wedge X^{r,s} \rightarrow X^{r+1,s} \quad \text{and} \quad \sigma_v : T \wedge X^{r,s} \rightarrow X^{r,s+1},$$

such that the diagram

$$\begin{array}{ccc}
 T \wedge X^{r,s+1} & \xrightarrow{\sigma_h} & X^{r+1,s+1} \\
 T \wedge \sigma_v \uparrow & & \uparrow \sigma_v \\
 T \wedge T \wedge X^{r,s} & \xrightarrow{t \wedge 1} & T \wedge T \wedge X^{r,s} \xrightarrow{T \wedge \sigma_h} T \wedge X^{r+1,s}
 \end{array}$$

commutes, where $t : T \wedge T \rightarrow T \wedge T$ is the isomorphism which flips smash factors. A T -bispectrum may alternatively be viewed as a T -spectrum object in the category of T -spectra, in the sense that the collections of objects $X^{r,*}$ form T -spectra for all $r \geq 0$, and the horizontal bonding maps σ_h determine morphisms $\sigma_{h*} : X^{r,*} \wedge T \rightarrow X^{r+1,*}$ given in levels by the composites

$$X^{r,s} \wedge T \xrightarrow[\cong]{t} T \wedge X^{r,s} \xrightarrow{\sigma_h} X^{r+1,s}.$$

There is of course another way to interpret X as a T -spectrum object, by starting with the T -spectra $X^{*,s}$ and taking bonding maps $X^{*,s} \wedge T \rightarrow X^{*,s+1}$ induced by the maps σ_v .

These definitions are analogous to those for ordinary bispectra [11]. Perhaps much of that machinery can be pushed through for T -bispectra — the trick for the moment is to avoid doing so.

A morphism $g : X \rightarrow Y$ of T -bispectra is a collection of maps

$$g : X^{r,s} \rightarrow Y^{r,s}$$

which preserve all structure. A map $g : X \rightarrow Y$ is said to be a *level equivalence* (respectively *fibration*) if each of the component maps $g : X^{r,s} \rightarrow Y^{r,s}$ is an equivalence (respectively fibration). It is an easy exercise, using the level model structure for T -spectra, to show that there is a level equivalence $i : X \rightarrow Y$ for every object X , such that Y is level fibrant.

Suppose that X is level fibrant. Then the map $\sigma_{h*} : X^{r,*} \wedge T \rightarrow X^{r+1,*}$ of T -spectra has an adjoint $\sigma_{h*} : X^{r,*} \rightarrow \Omega_T X^{r+1,*}$, and so there are commutative

diagrams

$$\begin{array}{ccc}
 X^{r,s} & \xrightarrow{\sigma_{h*}} & \Omega_T X^{r+1,s} \\
 \sigma_{v*} \downarrow & & \downarrow (\sigma_v)_* \\
 \Omega_T X^{r,s+1} & \xrightarrow{\Omega_T \sigma_{h*}} & \Omega_T^2 X^{r+1,s+1}
 \end{array}$$

One has to be careful here: the map $(\sigma_v)_*$ is the adjoint of the canonical choice of bonding map $\sigma_v : T \wedge \Omega_T X^{r+1,s} \rightarrow \Omega_T X^{r+1,s+1}$ for the T -spectrum $\Omega_T X^{r+1,s}$, and a calculation shows that there is a commutative diagram

$$\begin{array}{ccc}
 \Omega_T X^{r+1,s} & \xrightarrow{\Omega_T \sigma_{v*}} & \Omega_T^2 X^{r+1,s+1} \\
 \searrow (\sigma_v)_* & & \downarrow t^* \\
 & & \Omega_T^2 X^{r+1,s+1}
 \end{array}$$

where t^* is induced by flipping the loop factors. It follows that composing two instances of these diagrams give a picture

$$\begin{array}{ccc}
 X^{r,s} & \xrightarrow{\sigma_{h*}} & \Omega_T X^{r+1,s} \\
 \Omega_T(\sigma_{v*})\sigma_{v*} \downarrow & & \downarrow \Omega_T(\Omega_T(\sigma_{v*})\sigma_{v*}) \\
 & & \Omega_T^3 X^{r+1,s+2} \\
 & & \downarrow c_{2,1}^* \\
 \Omega_T^2 X^{r,s+2} & \xrightarrow{\Omega_T^2 \sigma_{h*}} & \Omega_T^3 X^{r+1,s+2}
 \end{array}$$

where $c_{2,1}^* = \Omega_T(t^*)t^*$ is induced in loop factors by the cyclic permutation $c_{2,1}$ of order 3.

Lemma 3.13 implies that the map c^* induces the identity in presheaves of homotopy groups. We therefore have a commutative diagram of presheaves of groups

$$\begin{array}{ccccc}
 \pi_j X^{r,s} & \longrightarrow & \pi_j \Omega_T^2 X^{r+2,s} & \longrightarrow & \dots \\
 \downarrow & & \downarrow & & \\
 \pi_j \Omega_T^2 X^{r,s+2} & \longrightarrow & \pi_j \Omega_T^4 X^{r+2,s+2} & \longrightarrow & \dots \\
 \downarrow & & \downarrow & & \\
 \vdots & & \vdots & &
 \end{array} \tag{4.9}$$

in which the horizontal morphisms induced by maps $\Omega_T^{2n}(\Omega_T(\sigma_h)\sigma_h)$ and the vertical maps are induced by maps $\Omega_T^{2n}(\Omega_T(\sigma_v)\sigma_v)$

Write $\pi_j QX^{r,s}$ for the filtered colimit of the diagram (4.9), and say that a map $g : X \rightarrow Y$ of level fibrant T -bispectra is a *stable equivalence* if it induces isomorphisms of presheaves of groups

$$\pi_j QX^{r,s} \xrightarrow[\cong]{g^*} \pi_j QY^{r,s}$$

for all j, r and s . One expands the definition of stable equivalence to arbitrary T -bispectra by declaring a map to be a stable equivalence if the induced map on level fibrant models is a stable equivalence.

The presheaves of groups $\pi_j QX^{r,s}$ are filtered colimits of presheaves of stable homotopy groups corresponding to both horizontal and vertical choices of T -spectra. This leads immediately to the following

LEMMA 4.21. *Suppose that $g : X \rightarrow Y$ is a map of T -bispectra such that either all maps $g : X^{r,*} \rightarrow Y^{r,*}$, $r \geq 0$, or all maps $g : X^{*,s} \rightarrow Y^{*,s}$, $s \geq 0$, are stable equivalences of T -spectra. Then g is a stable equivalence of T -bispectra.*

A T -bispectrum Y is said to be *stably fibrant* if it is level fibrant and all bonding maps $\sigma_h : Y^{r,s} \rightarrow \Omega_T Y^{r+1,s}$ and $\sigma_v : Y^{r,s} \rightarrow \Omega_T Y^{r,s+1}$ are equivalences (hence pointwise equivalences).

Every T -spectrum Z has an associated *suspension T -bispectrum* $\Sigma_T^\infty Z$ consisting of the objects

$$Z, Z \wedge T, Z \wedge T^2, \dots$$

The technical device that begins the proof of the main result of this section is the following:

LEMMA 4.22. *Let Z be a T -spectrum and suppose that Y is a stably fibrant T -bispectrum. Suppose that the morphism $g : \Sigma_T^\infty Z \rightarrow Y$ is a stable equivalence of T -bispectra. Then the map $g : Z \rightarrow Y^0$ at level 0 is a stable equivalence of T -spectra, and Y^0 is a stably fibrant T -spectrum.*

Proof. We can suppose that there is a level fibrant model $j : \Sigma_T^\infty Z \rightarrow X$ for $\Sigma_T^\infty Z$ such that the map g factors through j . Make the suspension index of $\Sigma_T^\infty Z$ the horizontal index, so that

$$(\Sigma_T^\infty Z)^{r,s} = Z^s \wedge T^r.$$

The map of T -spectra

$$X^{r,*} \xrightarrow{\Omega_T(\sigma_{h*})\sigma_{h*}} \Omega_T^2 X^{r+2,*}$$

is a stable equivalence by Theorem 3.11 and Lemma 3.15, and so there is an isomorphism

$$\pi_j(Q_T X^{r,*})^s \cong \varinjlim \pi_j \Omega_T^{2n} X^{r,s+2n} \cong \pi_j QX^{r,s}.$$

There is a similar isomorphism

$$\pi_j(Q_T Y^{r,*})^s \cong \varinjlim \pi_j \Omega_T^{2n} Y^{r,s+2n} \cong \pi_j QY^{r,s}.$$

since Y is stably fibrant. The morphisms

$$\pi_j QX^{r,s} \rightarrow \pi_j QY^{r,s}$$

are isomorphisms of presheaves of groups by assumption, so in particular the map

$$\pi_j(Q_T X^{0,*})^s \rightarrow \pi_j(Q_T Y^{0,*})^s$$

is an isomorphism as well. □

LEMMA 4.23. *Suppose that K is a pointed simplicial presheaf, and let $i : T \otimes K \rightarrow (T \otimes K)_s$ be a stably fibrant model for the symmetric T -spectrum $T \otimes K$. Then i induces a stable equivalence $Ui : U(T \otimes K) \rightarrow U(T \otimes K)_s$ of T -spectra.*

COROLLARY 4.24. *Suppose that K is a pointed simplicial presheaf. Then the map*

$$\Sigma_T^\infty K \xrightarrow{\eta_*} UV(\Sigma_T^\infty K)_s$$

is a stable equivalence.

Proof of Lemma 4.23. It suffices to find just one stably fibrant model for $T \otimes K$ which satisfies the statement of the lemma.

There is a T -spectrum object $\Sigma_T^\infty(T \otimes K)$ in the category of symmetric T -spectra, given by

$$\Sigma_T^\infty(T \otimes K)^n = (T \otimes K) \wedge T^n.$$

Suppose that n is the horizontal degree, so that the T -bispectrum underlying this object is specified in bidegrees by

$$U(\Sigma_T^\infty(T \otimes K))^{r,s} = T^s \wedge K \wedge T^r.$$

The functor Q_T and the level fibrant model functor \mathcal{L} are both simplicial functors, so the maps of T -spectra

$$T^s \wedge K \wedge T^* \rightarrow \mathcal{L}Q_T\mathcal{L}(T^s \wedge K \wedge T^*)$$

determine a map

$$\Sigma_T^\infty(T \otimes K) \rightarrow \mathcal{L}Q_T\mathcal{L}(\Sigma_T^\infty(T \otimes K))$$

of T -spectrum objects in the category of symmetric T -spectra whose underlying map of T -bispectra consists of stably fibrant models in each vertical degree. By Theorem 3.11, the vertical bonding map

$$\mathcal{L}Q_T\mathcal{L}(T^s \wedge K \wedge T^*) \rightarrow \Omega_T\mathcal{L}Q_T\mathcal{L}(T^{s+1} \wedge K \wedge T^*)$$

is a stable equivalence and hence a level equivalence, so that the T -bispectrum $U(\mathcal{L}Q_T\mathcal{L}(\Sigma_T^\infty(T \otimes K)))$ is stably fibrant. Thus, the symmetric T -spectrum $\mathcal{L}Q_T\mathcal{L}((T \otimes K) \wedge S^0)$ is stably fibrant, as is its underlying T -spectrum. Finally, Lemma 4.22 implies that the map of T -spectra

$$U((T \otimes K) \wedge S^0) \rightarrow U(\mathcal{L}Q_T\mathcal{L}((T \otimes K) \wedge S^0))$$

is a stable equivalence. □

LEMMA 4.25. *A map $g : X \rightarrow Y$ of symmetric T -spectra is a stable equivalence if and only if the suspension $g \wedge T : X \wedge T \rightarrow Y \wedge T$ is a stable equivalence.*

Proof. If g is a stable equivalence, then $g \wedge T$ is a stable equivalence, on account of the isomorphisms

$$\mathbf{hom}(X \wedge T, W) \cong \mathbf{hom}(X, \Omega_T W)$$

and the fact that the functor Ω_T preserves stably fibrant injective objects.

If $g \wedge T$ is a stable equivalence, then the natural stable equivalence $\sigma_* : W \rightarrow \Omega_T W[1]$ of (4.1) (see also Corollary 4.10) induces a diagram

$$\begin{array}{ccc} \mathbf{hom}(Y, W) & \xrightarrow{g^*} & \mathbf{hom}(X, W) \\ \simeq \downarrow & & \downarrow \simeq \\ \mathbf{hom}(Y, \Omega_T W[1]) & \xrightarrow{g^*} & \mathbf{hom}(X, \Omega_T W[1]) \\ \cong \downarrow & & \downarrow \cong \\ \mathbf{hom}(Y \wedge T, W[1]) & \xrightarrow{(g \wedge T)^*} & \mathbf{hom}(X \wedge T, W[1]) \end{array}$$

If $g \wedge T$ is a stable equivalence, then $(g \wedge T)^*$ is a weak equivalence for all stably fibrant injective W , so g^* is a weak equivalence for all such W . □

COROLLARY 4.26. *The composite*

$$\eta_* : X \xrightarrow{\eta} \Omega_T(X \wedge T) \xrightarrow{\Omega_T j} \Omega_T(X \wedge T)_s$$

is a stable equivalence of symmetric T -spectra, for any choice of stably fibrant model j for $X \wedge T$.

Proof. There is a diagram

$$\begin{array}{ccc} X \wedge T & \xrightarrow{\eta_* \wedge T} & \Omega_T(X \wedge T)_s \wedge T \\ & \searrow j & \downarrow ev \\ & & (X \wedge T)_s \end{array}$$

and the evaluation map ev is a stable equivalence of the underlying T -spectra by Corollary 3.16. Now use the Lemma 4.25. □

LEMMA 4.27. *The natural map $\eta_* : X \rightarrow U(VX)_s$ is a stable equivalence if and only if the map $\eta_* : X \wedge T \rightarrow U(V(X \wedge T))_s$ is a stable equivalence.*

Proof. There is a commutative diagram

$$\begin{array}{ccccc}
 X \wedge T & \xrightarrow{\eta \wedge T} & UV(X) \wedge T & \xrightarrow{Uj \wedge T} & U(VX)_s \wedge T \\
 & \searrow \eta & \cong \downarrow & & \cong \downarrow \\
 & & U(V(X) \wedge T) & \xrightarrow{U(j \wedge T)} & U((VX)_s \wedge T) \\
 & & \cong \downarrow & & \downarrow U\tilde{j} \\
 & & UV(X \wedge T) & \xrightarrow{Uj} & U(V(X \wedge T))_s
 \end{array}$$

Here $\tilde{j} : (VX)_s \wedge T \rightarrow (V(X \wedge T))_s$ is a map of symmetric T -spectra which makes the diagram

$$\begin{array}{ccc}
 V(X) \wedge T & \xrightarrow{j \wedge T} & V(X)_s \wedge T \\
 \cong \downarrow & & \downarrow \tilde{j} \\
 V(X \wedge T) & \xrightarrow{j} & (V(X \wedge T))_s
 \end{array}$$

commute — it exists since $j \wedge T$ is a trivial cofibration if $j : V(X) \rightarrow V(X)_s$ is a trivial cofibration. It therefore suffices to show that $U\tilde{j}$ is a stable equivalence of T -spectra.

It further suffices to show that the composite

$$UY \wedge T \xrightarrow{\cong} U(Y \wedge T) \xrightarrow{Uj} U(Y \wedge T)_s \tag{4.10}$$

is a stable equivalence if Y is a stably fibrant symmetric T -spectrum and $j : Y \wedge T \rightarrow (Y \wedge T)_s$ is a stably fibrant model. This, however, is a consequence of the commutativity of the diagram

$$\begin{array}{ccccccc}
 UY & \xrightarrow{\eta} & \Omega_T(UY \wedge T) & \xrightarrow{\cong} & \Omega_T U(Y \wedge T) & \xrightarrow{\Omega_T Uj} & \Omega_T U(Y \wedge T)_s \\
 & \searrow U\eta & & & \cong \downarrow & & \downarrow \cong \\
 & & & & U\Omega_T(Y \wedge T) & \xrightarrow{U\Omega_T j} & U\Omega_T(Y \wedge T)_s
 \end{array}$$

The top horizontal composite in this diagram is the adjoint of the composite (4.10), while the composite

$$Y \xrightarrow{\eta} \Omega_T(Y \wedge T) \xrightarrow{\Omega_T j} \Omega_T(Y \wedge T)_s$$

is a levelwise equivalence of stably fibrant symmetric T -spectra, by Corollary 4.26. \square

There are canonical stable equivalences

$$\Sigma_T^\infty K[-n] \wedge T^n \rightarrow \Sigma_T^\infty K$$

and

$$\Sigma_T^\infty X^n[-n] \rightarrow L_n X$$

where $L_n X$ is the n^{th} stage of the layer filtration for a T -spectrum X . The following is then a consequence of Corollary 4.24 and Lemma 4.27:

COROLLARY 4.28. 1) Suppose that K is a pointed simplicial presheaf. Then the map

$$\eta_* : \Sigma_T^\infty K[n] \rightarrow UV(\Sigma_T^\infty K[n])_s$$

is a stable equivalence for all $n \in \mathbb{Z}$.

2) Suppose that X is a T -spectrum. Then the map

$$\eta_* : L_n X \rightarrow UV(L_n X)_s$$

is a stable equivalence for all $n \geq 0$.

Proof. For part 2), recall that the functor V preserves stably trivial cofibrations and level equivalences, and hence preserves stable equivalences, so that the functor $X \mapsto U(VX)_s$ preserves stable equivalences. Part 2) is therefore a consequence of part 1), while 1) follows from Lemma 4.27. \square

LEMMA 4.29. Suppose that

$$X_0 \rightarrow X_1 \rightarrow \dots$$

is an inductive system of T -spectra such that all maps $\eta_* : X_n \rightarrow U(VX_n)_s$ are stable equivalences. Then the map

$$\eta_* : \varinjlim X_n \rightarrow UV(\varinjlim X_n)_s$$

is a stable equivalence.

Proof. There is a commutative diagram

$$\begin{array}{ccccc}
 & \varinjlim UV(X_n) & \xrightarrow{\varinjlim Uj} & \varinjlim U(V(X_n))_s & \\
 \nearrow \varinjlim \eta & & \cong \searrow & & \cong \searrow \\
 \varinjlim X_n & & U(\varinjlim V(X_n)) & \xrightarrow{U(\varinjlim j)} & U(\varinjlim V(X_n))_s \\
 \searrow \eta & & \cong \nearrow & & \nearrow U\tilde{j} \\
 & UV(\varinjlim X_n) & \xrightarrow{Uj} & UV(\varinjlim X_n)_s &
 \end{array}$$

where the displayed isomorphisms are canonical and \tilde{j} make the following diagram commute:

$$\begin{array}{ccc} \varinjlim V(X_n) & \xrightarrow{\varinjlim j} & \varinjlim V(X_n)_s \\ \cong \downarrow & & \downarrow \tilde{j} \\ V(\varinjlim X_n) & \xrightarrow{j} & V(\varinjlim X_n)_s \end{array}$$

Note that we can presume that the stably trivial cofibrations $j : V(X_n) \rightarrow V(X_n)_s$ of symmetric T -spectra can be chosen so that the induced map $\varinjlim j : \varinjlim V(X_n) \rightarrow \varinjlim V(X_n)_s$ is a stably trivial cofibration, so that the existence of the map \tilde{j} makes sense. This is the analogue of a step in the proof of Lemma 3.12 (a corresponding result, namely that stable equivalences are closed under filtered colimits, holds for symmetric T -spectra, via the same proof). It follows that \tilde{j} is a stable equivalence, but then Corollary 1.7 implies that \tilde{j} is a level equivalence, and so $U\tilde{j}$ is a level equivalence as well. Observe finally that Lemma 3.12 implies that the composite

$$\varinjlim X_n \xrightarrow{\varinjlim \eta} \varinjlim UV(X_n) \xrightarrow{\varinjlim Uj} \varinjlim U(V(X_n)_s)$$

is a stable equivalence. □

Corollary 4.28 and Lemma 4.29 together imply the following:

PROPOSITION 4.30. *The natural map $\eta_* : X \rightarrow U(V(X))_s$ is a stable equivalence for all T -spectra X .*

THEOREM 4.31. *The functors U and V induce an adjoint equivalence of stable homotopy categories*

$$\mathrm{Ho}(\mathbf{Spt}_T^\Sigma(\mathit{Sm}|_S)_{Nis}) \simeq \mathrm{Ho}(\mathbf{Spt}_T(\mathit{Sm}|_S)_{Nis})$$

Proof. We show that the adjoint pair of functors (U, V) is a Quillen equivalence.

Suppose that W is a stably fibrant symmetric T -spectrum. Then the canonical map $\epsilon : VU(W) \rightarrow W$ is a stable equivalence. To see this, take a factorization

$$\begin{array}{ccc} VU(W) & \xrightarrow{j} & (VU(W))_s \\ \epsilon \downarrow & \swarrow \tilde{j} & \\ W & & \end{array}$$

and apply the functor U to obtain the diagram

$$\begin{array}{ccccc} U(W) & \xrightarrow{\eta} & U(VU(W)) & \xrightarrow{Uj} & U(VU(W))_s \\ & \searrow 1 & U\epsilon \downarrow & \swarrow U\tilde{j} & \\ & & U(W) & & \end{array}$$

The composite $Uj \cdot \eta : U(W) \rightarrow U(VU(W))_s$ is a stable equivalence by Proposition 4.30, so that $U\tilde{j}$ is a stable equivalence of T -spectra. But then \tilde{j} is a stable equivalence of symmetric T -spectra by Proposition 4.8, and so $\epsilon : VU(W) \rightarrow W$ is a stable equivalence.

Proposition 4.13 implies that U preserves stable trivial fibrations, while it preserves stable fibrations by definition.

Suppose that X is a cofibrant T -spectrum and W is a stably fibrant symmetric T -spectrum. We have seen that $\epsilon : VU(W) \rightarrow W$ is a stable equivalence, and we also know that V preserves stable equivalences — see the proof of Corollary 4.28. Thus, if $f : X \rightarrow U(W)$ is a stable equivalence then the adjoint $f_* : V(X) \rightarrow W$ is a stable equivalence.

Conversely, if f_* is a stable equivalence, then f_* factors through a level equivalence $\tilde{f} : (V(X))_s \rightarrow W$, and there is a diagram

$$\begin{array}{ccccc}
 X & \xrightarrow{\eta} & UV(X) & \xrightarrow{Uf_*} & U(W) \\
 & \searrow \eta_* & \downarrow j & \nearrow U\tilde{f} & \\
 & & U(V(X))_s & &
 \end{array}$$

The map η_* is a stable equivalence by Proposition 4.30 and $U\tilde{f}$ is a level equivalence, so that f is a stable equivalence. □

4.5 SYMMETRIC S^1 -SPECTRA

The results proved above for symmetric T -spectra have analogues for symmetric S^1 -spectra, with proofs that are formally the same in many cases. These results will be summarized here.

The analogy begins with the definition. A *symmetric S^1 -spectrum* X is an S^1 -spectrum consisting of pointed simplicial presheaves X^n , $n \geq 0$, with bonding maps $\sigma : S^1 \wedge X^n \rightarrow X^{n+1}$, with symmetric group actions $\Sigma_n \times X^n \rightarrow X^{n+1}$, such that the composite bonding maps $S^p \wedge X^n \rightarrow X^{p+n}$ are $(\Sigma_p \times \Sigma_n)$ -equivariant. There is an obvious category of such things, which is denoted by $\mathbf{Spt}_{S^1}^\Sigma(Sm|_S)_{Nis}$. This category is, in the language of [13], the category of presheaves of symmetric spectra on the smooth Nisnevich site $(Sm|_S)_{Nis}$. We know from [13] that this category carries a well behaved stable closed model structure which is created by the Nisnevich topology. The point of this section is to show that there is an additional motivic stable closed model structure such that the associated homotopy category is equivalent to the motivic stable category for S^1 -spectra.

As for symmetric T -spectra, say that a map $f : X \rightarrow Y$ is a *level equivalence* if each component map $f : X^n \rightarrow Y^n$ is a motivic equivalence. The map f is a *level cofibration* if each $f : X^n \rightarrow Y^n$ is a cofibration of simplicial presheaves. Finally, a map $g : Z \rightarrow W$ is an *injective fibration* if it has the right lifting property with respect to all maps which are level cofibrations and level weak equivalences. We then have the following:

THEOREM 4.32. *The category $\mathbf{Spt}_{S^1}^\Sigma(Sm|_S)_{Nis}$ of symmetric S^1 -spectra on the smooth Nisnevich site, together with the classes of level cofibrations, level equivalences and injective fibrations, satisfies the axioms for a proper closed simplicial model category.*

The proof of this result is just like that of Theorem 4.2: the controlled level fibrant construction $Y \mapsto \mathcal{L}(Y)$ for simplicial presheaves extends to a functor on symmetric S^1 -spectra (diagram (1.2)), and we know from [13] that level cofibrations and level local equivalences of symmetric S^1 -spectra satisfy a bounded cofibration condition. These two facts can be used together with the argument in the proof of Proposition 2.15 to show that the level motivic equivalences and level cofibrations of symmetric S^1 -spectra satisfy a bounded cofibration condition. The rest of the proof is formal.

The definition and properties of the left adjoint V to the forgetful functor

$$U : \mathbf{Spt}_{S^1}^\Sigma(Sm|_S)_{Nis} \rightarrow \mathbf{Spt}_{S^1}(Sm|_S)_{Nis}$$

taking values in S^1 -spectra are already well known.

We say that a map $p : X \rightarrow Y$ of symmetric S^1 -spectra is a *stable fibration* if the underlying map $Up : UX \rightarrow UY$ of S^1 -spectra is a (motivic) stable fibration. Proposition 2.15 has an analogue for S^1 -spectra which implies that a map $q : Z \rightarrow W$ of S^1 -spectra is a stable fibration if and only if it has the right lifting property with respect to all λ -bounded cofibrations $A \rightarrow B$ which are stable equivalences. It follows that a map $p : X \rightarrow Y$ of symmetric S^1 -spectra is a stable fibration if and only if it has the right lifting property with respect to images $V(A) \rightarrow V(B)$ of all λ -bounded trivial cofibrations of S^1 -spectra under the functor V . This implies the following analogue of Proposition 4.4:

PROPOSITION 4.33. *Every map $f : X \rightarrow Y$ of symmetric S^1 -spectra has a natural factorization*

$$\begin{array}{ccc} X & \xrightarrow{j} & Z \\ & \searrow f & \downarrow p \\ & & Y \end{array}$$

such that p is a stable fibration, and j is a level cofibration which has the left lifting property with respect to all stable fibrations.

As before, this result implies the existence of injective stably fibrant models.

Say that a map $f : X \rightarrow Y$ of symmetric S^1 -spectra is a *stable equivalence* if it induces a weak equivalence

$$g^* : \mathbf{hom}(Y, W) \rightarrow \mathbf{hom}(X, W)$$

for all stably fibrant injective objects W .

The shift construction $X \mapsto X[n]$, the natural map $X \rightarrow \Omega X[1]$ and the symmetric stabilization functor $X \mapsto Q^\Sigma X = Q_{S^1}^\Sigma X$ are already well known [7], [13], and the same argument as for Proposition 4.8 gives the following:

PROPOSITION 4.34. *Suppose that $\alpha : X \rightarrow Y$ is a map of symmetric S^1 -spectra such that $U\alpha : UX \rightarrow UY$ is a stable equivalence of S^1 -spectra. Then α is a stable equivalence of symmetric S^1 -spectra.*

The description $X \mapsto G_n(S^0) \otimes X$ of the left adjoint to the shift functor is also well known. This functor preserves level cofibrations and level weak equivalences by construction and the properness of the unstable motivic closed model structure, so that the adjoint $Y \mapsto Y[n]$ preserves injective fibrations. In particular, if W is stably fibrant and injective, then the canonical map $W \rightarrow \Omega W[1]$ is a level equivalence of stably fibrant injective objects. The function complex $\mathbf{hom}(X, W)$ is therefore an infinite loop space for all symmetric S^1 -spectra X and stably fibrant injective objects W , so that we can prove

LEMMA 4.35. *Suppose that the commutative diagram*

$$\begin{array}{ccccc} A_1 & \xrightarrow{i_1} & B_1 & \xrightarrow{\pi_1} & B_1/A_1 \\ f_1 \downarrow & & \downarrow f_2 & & \downarrow f_3 \\ A_2 & \xrightarrow{i_2} & B_2 & \xrightarrow{\pi_2} & B_2/A_2 \end{array}$$

is a comparison diagram of level cofibre sequences. Then if any two of the maps f_1 , f_2 and f_3 are stable equivalences of symmetric S^1 -spectra, then so is the third.

The proof is by analogy with the proof of Lemma 4.11.

Insofar as we know that fibre and cofibre sequences coincide in the motivic stable category of S^1 -spectra (Corollary 3.2), we also have the analogue of Corollary 4.12, and this implies

PROPOSITION 4.36. *Suppose that $p : X \rightarrow Y$ is a map of symmetric S^1 -spectra which is both a stable fibration and a stable equivalence. Then p is a level equivalence.*

COROLLARY 4.37. *A map $p : X \rightarrow Y$ of symmetric S^1 -spectra is a stable fibration and a stable equivalence if and only if it is both a level fibration and a level equivalence.*

Say that a map $i : A \rightarrow B$ of symmetric S^1 -spectra is a *stable cofibration* if it has the left lifting property with respect to all maps $p : X \rightarrow Y$ which are stable equivalences and stable fibrations. Then we have

THEOREM 4.38. *The category $\mathbf{Spt}_{S^1}^{\Sigma}(Sm|_S)_{Nis}$ of symmetric S^1 -spectra on the smooth Nisnevich site, and the classes of stable equivalences, stable fibrations and stable cofibrations, together satisfy the axioms for a proper closed simplicial model category.*

Write η_* for the composite

$$X \xrightarrow{\eta} UVX \xrightarrow{Uj} U(VX)_s$$

where $j : VX \rightarrow (VX)_s$ is a stably fibrant model of the symmetric S^1 -spectrum VX . Then Proposition 4.30 translates as follows:

PROPOSITION 4.39. *The natural map $\eta_* : X \rightarrow U(VX)_s$ is a stable equivalence for all S^1 -spectra X .*

Just as before, this is the key step in demonstrating that the category of symmetric spectrum objects is a model for the stable category:

THEOREM 4.40. *The functors U and V induce an adjoint equivalence of stable homotopy categories*

$$\mathrm{Ho}(\mathbf{Spt}_{S^1}^\Sigma(\mathrm{Sm}|_S)_{\mathrm{Nis}}) \simeq \mathrm{Ho}(\mathbf{Spt}_{S^1}(\mathrm{Sm}|_S)_{\mathrm{Nis}})$$

Again, one shows that the adjoint pair of functors (U, V) is a Quillen equivalence.

The proofs of Proposition 4.30 and Theorem 4.31 occupied all of Section 4.4, and the proofs of Proposition 4.39 and Theorem 4.40 are exactly the same, subject to replacing T by S^1 . As before, the interesting part is proving Proposition 4.39 in the case of suspension objects — the analogue is Lemma 4.23. That proof involved T -bispectra, which translates here to S^1 -bispectra, or presheaves of bispectra in the sense of [11], but interpreted in motivic homotopy theory.

Finally, the categorical material on smash products in Section 4.3 arises from manipulations of free functors that are well known for ordinary symmetric spectra, and therefore hold for symmetric S^1 -spectra. The homotopically significant statement is Proposition 4.19:

PROPOSITION 4.41. *Suppose that $i : A \rightarrow B$ is a stable cofibration and that $j : C \rightarrow D$ is a level cofibration. Then the map*

$$(i, j)_* : (B \wedge C) \cup_{(A \wedge C)} (A \wedge D) \rightarrow B \wedge D$$

is a level cofibration. If i and j are both cofibrations, then $(i, j)_$ is a cofibration. If either i or j is a stable equivalence, then $(i, j)_*$ is a stable equivalence.*

The statement and proof of this result are really quite generic, and hold essentially anywhere that one succeeds in generating the usual machinery of symmetric spectrum objects. This includes the present discussion of symmetric S^1 -spectra in the motivic context, and also translates into a statement for presheaves of symmetric spectra in the sense of [13].

APPENDICES

A PROPERNESS

The purpose of this section is to show that the closed model structure that arises from formally collapsing a simplicial presheaf I to a point satisfies the properness axiom. This is true over arbitrary small Grothendieck sites and, more explicitly, for the f -local theory for any rational point $f : * \rightarrow I$. This result specializes to properness for motivic homotopy theory: that is the case of a rational point $* \rightarrow \mathbb{A}^1$ on the affine line, in the category of simplicial presheaves (or sheaves) for the site $(Sm|_S)_{Nis}$ of smooth k -schemes equipped with the Nisnevich topology. I shall revert to the original homotopy theoretic notation (see also Section 1.2) for the general discussion that follows.

Suppose that \mathcal{C} is a small Grothendieck site, and let α be a cardinal which is an upper bound for the cardinality of the set $\text{Mor}(\mathcal{C})$ of morphisms of \mathcal{C} . Suppose that I is a simplicial presheaf on \mathcal{C} having a rational point $f : * \rightarrow I$. We will show that the f -local closed model structure on $\mathbf{SPre}(\mathcal{C})$ is proper, for any such map $f : * \rightarrow I$.

Let D be a simplicial presheaf on the site \mathcal{C} , and write $f : D \rightarrow D \times I$ for the composite

$$D \cong D \times * \xrightarrow{1_D \times f} D \times I.$$

LEMMA A.1. *Suppose given maps*

$$D \xrightarrow{f} D \times I \xrightarrow{g} X$$

and a global fibration $\pi : U \rightarrow X$, and suppose that X is f -fibrant. Then the induced map

$$f_* : U \times_X D \rightarrow U \times_X (D \times I)$$

is an f -equivalence.

Proof. To make the notation easier, given a map $\alpha : V \rightarrow X$, write $V_\alpha = U \times_X V$ for the pullback of α along $\pi : U \rightarrow X$. In this notation, the statement of the lemma is the assertion that the induced map

$$f_* : D_{gf} \rightarrow (D \times I)_g$$

is an f -equivalence.

The object X is f -fibrant and the projection map $pr : D \times I \rightarrow D$ is an f -equivalence, so there is a simplicial homotopy

$$\begin{array}{ccc} D \times I & \xrightarrow{d^0} & (D \times I) \times \Delta^1 \xleftarrow{d^1} D \times I \\ pr \downarrow & & \downarrow h \\ D & \xrightarrow{gf} & X \end{array} \quad \swarrow g$$

Pulling back along the global fibration $\pi : U \rightarrow X$ gives a diagram

$$\begin{array}{ccccc}
 D_{gf} & \xrightarrow{d_*^0} & (D \times \Delta^1)_{h(f \times 1)} & \xleftarrow{d_*^1} & D_{gf} \\
 f_* \downarrow & & \downarrow (f \times 1)_* & & \downarrow f_* \\
 (D \times I)_{gf \cdot pr} & \xrightarrow{d_*^0} & (D \times I \times \Delta^1)_h & \xleftarrow{d_*^1} & (D \times I)_g
 \end{array}$$

All of the maps labeled d_*^ϵ are local weak equivalences, since π is a global fibration and the ordinary closed model structure for $\mathbf{SPre}(\mathcal{C})$ is proper. It therefore suffices to show that the map $f_* : D_{gf} \rightarrow (D \times I)_{gf \cdot pr}$ is an f -equivalence.

But the map $gf \cdot pr$ factors through the projection map pr , so that there is an isomorphism

$$\theta : (D \times I)_{gf \cdot pr} \xrightarrow{\cong} D_{gf} \times I$$

and a commutative diagram

$$\begin{array}{ccc}
 D_{gf} & & \\
 f_* \downarrow & \searrow f & \\
 (D \times I)_{gf \cdot pr} & \xrightarrow[\theta]{\cong} & D_{gf} \times I
 \end{array}$$

The map f_* is therefore an f -equivalence. □

An *elementary f -trivial cofibration* is a member of the saturation of the family of cofibrations consisting of the maps

$$(* \times L_U \Delta^n) \cup_{(* \times Y)} (I \times Y) \subset I \times L_U \Delta^n,$$

and all maps

$$C \hookrightarrow D$$

which are cofibrations and local weak equivalences, where D is α -bounded. An *f -injective fibration* is a map $p : Z \rightarrow W$ which has the right lifting property with respect to all elementary f -trivial cofibrations.

- LEMMA A.2. 1) *An f -injective fibration p is a global fibration.*
- 2) *The class of f -injective fibrations is closed under composition.*
- 3) *A simplicial presheaf Z is f -local if and only if the map $Z \rightarrow *$ is an f -injective fibration.*

4) Every simplicial presheaf map $g : X \rightarrow Y$ has a factorization

$$\begin{array}{ccc} X & \xrightarrow{g} & Y \\ & \searrow j & \nearrow q \\ & & W \end{array}$$

where q is an f -injective fibration and j is an elementary f -cofibration and an f -equivalence.

5) Every elementary f -cofibration is an f -equivalence.

Proof. Part 4) is the consequence of a standard transfinite small object argument.

The family of maps having the left lifting property with respect to all f -injective fibrations is a saturated class containing the generating elementary f -cofibrations, so that the elementary f -cofibrations have the left lifting property with respect to all f -injective fibrations. It follows from the factorization statement 4) that every elementary f -cofibration is a retract of an elementary f -cofibration which is an f -equivalence. But then every elementary f -cofibration is an f -equivalence, giving 5). \square

Now we can list some consequences of Lemmas A.1 and A.2:

LEMMA A.3. Suppose given maps

$$C \xrightarrow{j} D \xrightarrow{g} X$$

and a global fibration $\pi : U \rightarrow X$, and suppose that X is f -fibrant and j is an elementary f -cofibration. Then the induced map

$$j_* : U \times_X C \rightarrow U \times_X D$$

is an f -equivalence.

Proof. The class of cofibrations $C \hookrightarrow D \rightarrow X$ over X which pull back to f -equivalences $U \times_X C \rightarrow U \times_X D$ is saturated by exactness of pullback, and contains all ordinary trivial cofibrations since the standard closed model structure on $\mathbf{SPre}(\mathcal{C})$ is proper.

In any diagram

$$\begin{array}{ccccc} Y & \xrightarrow{\quad} & L_U \Delta^n & & \\ f \downarrow & & f_* \downarrow & \searrow f & \\ I \times Y & \xrightarrow{\quad} & (I \times Y) \cup_Y L_U \Delta^n & \xrightarrow{\quad} & I \times L_U \Delta^n \xrightarrow{g} X \\ & & \theta \searrow & & \end{array}$$

the maps f and f_* pull back to f -equivalences along π by Lemma A.1, and so θ pulls back to an f -equivalence along π . This means that all generators of the family of elementary f -cofibrations pull back to f -equivalences along π , so all elementary f -cofibrations pull back to f -equivalences along π . \square

COROLLARY A.4. *Suppose given a pullback diagram*

$$\begin{array}{ccc} A \times_X U & \xrightarrow{g_*} & U \\ \downarrow & & \downarrow \pi \\ A & \xrightarrow{g} & X \end{array}$$

where X is f -fibrant, g is an f -equivalence and π is a global fibration. Then the induced map g_* is an f -equivalence.

Proof. Find a factorization

$$\begin{array}{ccc} A & \xrightarrow{g} & X \\ & \searrow j & \nearrow q \\ & W & \end{array}$$

of g , where j is an elementary f -cofibration and q is an f -injective fibration. Then W is f -fibrant by Lemma A.2, and the fact that the classes of f -fibrant objects and f -injective objects coincide [4]. Thus, q is an f -equivalence of f -fibrant objects, and is therefore an ordinary local weak equivalence, and hence pulls back to a local weak equivalence along the global fibration π . But then the elementary f -cofibration j pulls back to an f -equivalence by Lemma A.3. \square

THEOREM A.5 (PROPERNESS). *Suppose given a diagram*

$$\begin{array}{ccc} A \times_X U & \xrightarrow{g_*} & U \\ \downarrow & & \downarrow \pi \\ A & \xrightarrow{g} & Z \end{array}$$

such that π is an f -fibration and g is an f -equivalence. Then the induced map g_* is an f -equivalence.

Proof. Form a diagram

$$\begin{array}{ccc} U & \xrightarrow{i} & V \\ \pi \downarrow & & \downarrow p \\ Z & \xrightarrow{j} & \mathcal{L}Z \end{array}$$

such that i is a cofibration and an f -equivalence, $\mathcal{L}Z$ is f -fibrant, p is an f -fibration, and j is a cofibration and an f -equivalence. Consider the pullback diagram

$$\begin{array}{ccc} Z \times_{\mathcal{L}Z} V & \xrightarrow{j_*} & V \\ p_* \downarrow & & \downarrow p \\ Z & \xrightarrow{j} & \mathcal{L}Z \end{array}$$

The map $j_* : Z \times_{\mathcal{L}Z} V \rightarrow V$ is an f -equivalence by Corollary A.4. The induced comparison

$$\begin{array}{ccc} U & \xrightarrow{\theta} & Z \times_{\mathcal{L}Z} V \\ \pi \searrow & & \swarrow p_* \\ & Z & \end{array}$$

is an f -equivalence of f -fibrant objects in $\mathbf{SPre}(\mathcal{C}) \downarrow X$, hence a homotopy equivalence, and so the map θ is a local weak equivalence. Properness for the standard closed model structure on $\mathbf{SPre}(\mathcal{C})$ implies that the induced map

$$A \times_Z U \xrightarrow{\theta_*} A \times_{\mathcal{L}Z} V$$

is a local weak equivalence. Thus, in the diagram

$$\begin{array}{ccc} A \times_Z U & \xrightarrow{g_*} & U \\ \theta_* \downarrow & & \downarrow \theta \\ A \times_{\mathcal{L}Z} V & \xrightarrow{g'} & Z \times_{\mathcal{L}Z} V \end{array}$$

the map g_* is an f -equivalence if and only if g' is an f -equivalence. But the maps $j_* g'$ and j_* are f -equivalences by Corollary A.4, so g' is an f -equivalence. \square

Theorem A.5 is not the full properness assertion for the f -local theory but it is the heart of the matter. The second half of the properness axiom says that the class of f -equivalences is closed under pushout along cofibrations. This means that, given a pushout diagram

$$\begin{array}{ccc} A & \xrightarrow{g} & C \\ i \downarrow & & \downarrow \\ B & \xrightarrow{g_*} & B \cup_A C \end{array}$$

with i a cofibration and g an f -equivalence, the map g_* should be an f -equivalence. This is easily proved: the functor $\mathbf{hom}(_, W)$ takes pushouts of simplicial presheaves to pullbacks of simplicial sets, and the map $i^* : \mathbf{hom}(B, W) \rightarrow \mathbf{hom}(A, W)$ is a fibration and $g^* : \mathbf{hom}(C, W) \rightarrow \mathbf{hom}(A, W)$ is a weak equivalence if W is f -local. Properness for ordinary simplicial sets implies that the induced map

$$g_*^* : \mathbf{hom}(B \cup_A C, W) \rightarrow \mathbf{hom}(B, W)$$

is a weak equivalence of simplicial sets. This is true for all f -local objects W , so that g_* is an f -equivalence.

B MOTIVIC HOMOTOPY THEORY OF PRESHEAVES

Let $\mathbf{S} \text{Shv}(Sm|_S)_{Nis}$ (respectively $\text{Shv}(Sm|_S)_{Nis}$) denote the category of simplicial sheaves (respectively sheaves) on the smooth Nisnevich site $(Sm|_S)_{Nis}$ for a Noetherian scheme S of finite dimension. Suppose that $\text{Pre}(Sm|_S)_{Nis}$ and $\mathbf{S} \text{Pre}(Sm|_S)_{Nis}$ denote the corresponding categories of presheaves and simplicial presheaves. We know that the categories of simplicial sheaves and simplicial presheaves carry closed model structures obtained from the local structures for the Nisnevich topology by formally contracting the affine line \mathbb{A}^1 , and that the resulting homotopy categories are equivalent, and are models for the motivic homotopy category — see Theorem 1.1 and Theorem 1.2.

The purpose of this section is to explain the Morel-Voevodsky result that the sheaf category $\text{Shv}(Sm|_S)_{Nis}$ inherits a closed model structure from the category of simplicial sheaves in such a way that the associated homotopy category is also a model for the motivic homotopy category. We actually do a little more here (Theorem B.4 below), and show that the category of presheaves $\text{Pre}(Sm|_S)_{Nis}$ has a proper closed simplicial model structure, so that there is an adjoint equivalence of the associated homotopy category $\text{Ho}(\text{Pre}(Sm|_S)_{Nis})$ with the motivic homotopy category. The Morel-Voevodsky result for sheaves (Theorem B.6) is a consequence of Theorem B.4, in a way that one has come to expect.

Morel and Voevodsky construct a singular functor

$$S = S_{\mathbb{A}^1} : \mathbf{S} \text{Shv}(Sm|_S)_{Nis} \rightarrow \mathbf{S} \text{Shv}(Sm|_S)_{Nis}$$

in terms of the internal hom functor by specifying $S(B) = \mathbf{Hom}(\mathbb{A}^\bullet, B)$ for ordinary sheaves B , and then by defining $S(X)$ for a simplicial sheaf X to be the diagonal of the bisimplicial object

$$\mathbf{Hom}(\mathbb{A}^m, X_n).$$

Here, \mathbb{A}^\bullet refers to the standard cosimplicial k -variety made up of the affine planes \mathbb{A}^n . The singular functor specializes, in particular, to a functor

$$S : \text{Shv}(Sm|_S)_{Nis} \rightarrow \mathbf{S} \text{Shv}(Sm|_S)_{Nis},$$

This last functor has a canonical left adjoint

$$|\cdot| : \mathbf{S} \operatorname{Shv}(Sm|_S)_{Nis} \rightarrow \operatorname{Shv}(Sm|_S)_{Nis},$$

which is defined by a suitable coend. This means that there is a coequalizer in the sheaf category having the form

$$\bigsqcup_{\theta: \mathbf{m} \rightarrow \mathbf{n}} X_n \times \mathbb{A}^m \rightrightarrows \bigsqcup_n X_n \times \mathbb{A}^n \rightarrow |X|$$

for a simplicial sheaf X that one expects from the definition of the realization functor from simplicial sets to spaces. Morel and Voevodsky show [14] that, for a suitable closed model structure on the sheaf category $\operatorname{Shv}(Sm|_S)_{Nis}$, these functors define an adjoint equivalence of the associated homotopy categories.

These constructions are easily generalized to simplicial presheaves, with completely analogous definitions. There is a *singular functor*

$$S = S_{\mathbb{A}^1} : \mathbf{S} \operatorname{Pre}(Sm|_S)_{Nis} \rightarrow \operatorname{Pre}(Sm|_S)_{Nis}$$

which is defined on presheaves C by setting $S(C) = \mathbf{Hom}(\mathbb{A}^\bullet, C)$; then $S(Y)$ is defined for a simplicial presheaf Y by taking the diagonal of the bisimplicial presheaf

$$\mathbf{Hom}(\mathbb{A}^m, Y_n).$$

There is a *realization functor*

$$|\cdot| : \mathbf{S} \operatorname{Pre}(Sm|_S)_{Nis} \rightarrow \operatorname{Pre}(Sm|_S)_{Nis},$$

defined by coend, so that there is a coequalizer

$$\bigsqcup_{\theta: \mathbf{m} \rightarrow \mathbf{n}} Y_n \times \mathbb{A}^m \rightrightarrows \bigsqcup_n Y_n \times \mathbb{A}^n \rightarrow |Y|$$

in the presheaf category, for simplicial presheaves Y . The realization functor is left adjoint to the singular functor, just as before.

We now have the following analogue of a string of results for the singular functor on simplicial sheaves, proved by Morel and Voevodsky in [14]:

LEMMA B.1. *The singular functor*

$$S : \mathbf{S} \operatorname{Pre}(Sm|_S)_{Nis} \rightarrow \operatorname{Pre}(Sm|_S)_{Nis}$$

has the following properties:

- 1) *The functor S takes the morphism $f : * \rightarrow \mathbb{A}^1$ to a weak equivalence of simplicial sheaves.*
- 2) *For any simplicial presheaf X , the canonical map $\eta : X \rightarrow S(X)$ is a motivic weak equivalence and a cofibration.*

3) *The realization functor preserves cofibrations and motivic weak equivalences.*

Proof. For 1), it suffices to show that the simplicial set

$$S(\mathbb{A}^1)(Sp(R)) \cong R[t_*]$$

is contractible for affine schemes $Sp(R)$, where $R[t_*]$ is the simplicial R -algebra with n -simplices

$$R[t_*]_n = R[t_0, \dots, t_n] / (\sum t_i = 1),$$

and having face maps defined by

$$d_i(t_j) = \begin{cases} t_j & \text{if } j < i, \\ 0 & \text{if } j = i, \text{ and} \\ t_{j-1} & \text{if } j > i. \end{cases}$$

It is well known (for many years — see [1], for example) that the simplicial set underlying this simplicial R -algebra is contractible, with contracting (chain) homotopy given by

$$f(t_0, \dots, t_n) \mapsto (1 - t_0)f(t_1, \dots, t_{n+1}).$$

For 2), the canonical map η for simplicial sets is the diagonal of a corresponding bisimplicial set map made of canonical maps $\eta : B \rightarrow \mathbf{Hom}(\mathbb{A}^\bullet, B)$ defined for simplicial presheaves B . This map is a morphism of simplicial presheaves which on n -simplices is the map

$$B \rightarrow \mathbf{Hom}(\mathbb{A}^n, B) \tag{B.1}$$

defined by precomposition with the map $\mathbb{A}^n \rightarrow *$. There is a contracting homotopy $h : \mathbb{A}^n \times \mathbb{A}^1 \rightarrow \mathbb{A}^n$ defined by

$$((t_1, \dots, t_n), s) \mapsto (t_1 s, \dots, t_n s).$$

This contracting homotopy induces an obvious map

$$h_* : \mathbf{Hom}(\mathbb{A}^n, B) \times \mathbb{A}^1 \rightarrow \mathbf{Hom}(\mathbb{A}^n, B),$$

and the existence of the homotopy h_* implies that the map (B.1) is an \mathbb{A}^1 homotopy equivalence, and hence a motivic weak equivalence. The motivic model structure for the simplicial presheaf category is proper, so that standard techniques imply that the map $\eta : X \rightarrow S(X)$ is a motivic weak equivalence for all simplicial presheaves X .

To prove statement 3), observe that any cosimplicial set E determines a set-valued realization functor $X \mapsto |X|_E$ defined on simplicial sets by the coequalizer

$$\bigsqcup_{\theta: \mathbf{m} \rightarrow \mathbf{n}} X_n \times E^m \rightrightarrows \bigsqcup_n X_n \times E^n \rightarrow |Y|_E.$$

One sees easily that there is a bijection $|\Delta^n|_E \rightarrow E^n$ defined by the maps $\Delta_k^n \times D^k \rightarrow D^n$ given by $(\theta, x) \mapsto \theta_*(x)$. This bijection is natural in ordinal number maps; in particular, the induced function $|\partial\Delta^1|_E \rightarrow |\Delta^1|_E$ is isomorphic to the function

$$(d^0, d^1) : E^0 \sqcup E^0 \rightarrow E^1.$$

Also, all diagrams

$$\begin{array}{ccc} E^{n-2} & \xrightarrow{d^{j-1}} & E^{n-1} \\ d^i \downarrow & & \downarrow d^i \\ E^{n-1} & \xrightarrow{d^j} & E^n \end{array}$$

corresponding to $i < j$ are pullbacks by the cosimplicial identities for $n \geq 2$. Thus, there is an isomorphism

$$|\partial\Delta^n|_E \cong \partial E^n,$$

where ∂E^n denotes the union of the images $d^i(E^{n-1})$ in E^n , and that the induced map $|\partial\Delta^n|_E \rightarrow |\Delta^n|_E$ is an injection for $n \geq 2$. It follows that the realization functor $X \mapsto |X|_E$ takes cofibrations to injections if and only if E is *unaugmented* in the (traditional — see [3]) sense that the diagram

$$\begin{array}{ccc} \emptyset & \longrightarrow & E^0 \\ \downarrow & & \downarrow d^0 \\ E^0 & \longrightarrow & E^1 \end{array}$$

is a pullback.

Also, if E is unaugmented, one can show that the natural map

$$X_0 \times E^0 \rightarrow |X|_E$$

is an inclusion, by induction on the skeleta of X .

Any cosimplicial object D in the category of simplicial presheaves determines a D -realization functor $Y \mapsto |Y|_D$, defined by a coequalizer diagram

$$\bigsqcup_{\theta: \mathbf{m} \rightarrow \mathbf{n}} Y_n \times D^m \rightrightarrows \bigsqcup_n Y_n \times D^n \rightarrow |Y|_D.$$

as above. Write $|Y|_D^{(p)}$ for the image of

$$\bigsqcup_{0 \leq n \leq p} Y_n \times D^n$$

in $|Y|_D$, and let $s_{[p]}Y_p$ be the degenerate part of Y_{p+1} . Then there is a pushout diagram

$$\begin{array}{ccc} (s_{[p]}Y_p \times D^{p+1}) \cup (Y_{p+1} \times \partial D^{p+1}) & \longrightarrow & |Y|_D^{(p)} \\ \downarrow & & \downarrow \\ Y_{p+1} \times D^{p+1} & \longrightarrow & |Y|_D^{(p+1)} \end{array}$$

The vertical maps are cofibrations, and the canonical map

$$Y_0 \times D^0 \rightarrow |Y|_D^{(0)}$$

is an isomorphism if D is unaugmented.

A properness argument therefore implies that any level motivic equivalence $D \rightarrow E$ of unaugmented cosimplicial presheaves induces a natural motivic equivalence $|Y|_D \rightarrow |Y|_E$. In particular, the maps of cosimplicial objects

$$\mathbb{A}^n \leftarrow \mathbb{A}^n \times \Delta^n \rightarrow \Delta^n$$

are level motivic equivalences, and so there are natural motivic equivalences

$$|Y|_{\mathbb{A}^\bullet} \leftarrow |Y|_{\mathbb{A}^\bullet \times \Delta} \rightarrow |Y|_{\Delta} \cong Y.$$

The realization functor $Y \mapsto |Y| = |Y|_{\mathbb{A}^\bullet}$ therefore preserves motivic equivalences. It follows also that this realization functor preserves cofibrations of simplicial presheaves. \square

COROLLARY B.2. *The singular functor preserves fibrations.*

COROLLARY B.3. *There is a natural motivic weak equivalence $Y \simeq |Y|$, for all simplicial presheaves Y .*

Say that a map $g : X \rightarrow Y$ of presheaves on the smooth Nisnevich site $(Sm|_S)_{Nis}$ is a *motivic weak equivalence* if the associated morphism of constant simplicial presheaves is a motivic weak equivalence. A *cofibration* of presheaves is an inclusion, and a *motivic fibration* is a map which has the right lifting property with respect to all maps which are simultaneously cofibrations and motivic weak equivalences.

Given a presheaf X and a simplicial set K , write $X \otimes K$ for the presheaf given by

$$X \otimes K = |X \times K|.$$

There is an isomorphism

$$X \otimes K \cong \varinjlim_{\sigma: \Delta^n \rightarrow K} X \otimes \Delta^n,$$

where the colimit is indexed over the simplex category of K , and one checks that there is a natural isomorphism

$$X \otimes \Delta^n \cong X \times \mathbb{A}^n.$$

The category of presheaves on $(Sm|_S)_{Nis}$ acquires a simplicial structure from these definitions: the function complex $\mathbf{hom}(X, Y)$ has n -simplices specified by

$$\mathbf{hom}(X, Y)_n = \mathbf{hom}(X \otimes \Delta^n, Y) \cong \mathbf{hom}(X \times \mathbb{A}^n, Y),$$

while for a simplicial set K and a presheaf X , the mapping presheaf $\mathbf{hom}(K, X)$ is given in terms of the internal hom functor by

$$\mathbf{hom}(K, X) = \varinjlim_{\sigma: \Delta^n \rightarrow K} \mathbf{Hom}(\mathbb{A}^n, X).$$

THEOREM B.4. *With these definitions, we have the following:*

- 1) *The category $\mathbf{Pre}(Sm|_S)_{Nis}$ of presheaves on the smooth Nisnevich site of a Noetherian scheme S of finite dimension satisfies the axioms for a proper closed simplicial model category.*
- 2) *The singular and realization functors determine an adjoint equivalence of motivic homotopy categories*

$$\mathbf{Ho}(\mathbf{Pre}(Sm|_S)_{Nis}) \simeq \mathbf{Ho}(\mathbf{SPre}(Sm|_S)_{Nis}).$$

Proof. Recall from [4, p.1086] that the category $\mathbf{SPre}(Sm|_S)_{Nis}$ of simplicial presheaves on the smooth Nisnevich site and the class \mathbf{E} of motivic weak equivalences together satisfy a list of properties analogous to those appearing in the statement of Proposition 4.1. These include, for example, the bounded cofibration condition:

- E7:** There is an infinite cardinal λ which is an upper bound for the cardinality of the set of morphisms of $(Sm|_S)_{Nis}$, such that for every simplicial presheaf diagram

$$\begin{array}{ccc} & & X \\ & & \downarrow i \\ A & \longrightarrow & Y \end{array}$$

with i an \mathbf{E} -trivial cofibration and A an λ -bounded subobject of Y , there is a subobject $B \subset Y$ such that $A \subset B$, the object B is λ -bounded, and the inclusion $B \cap X \hookrightarrow B$ is an \mathbf{E} -trivial cofibration.

Here, an \mathbf{E} -trivial cofibration is a map which is a cofibration and a motivic weak equivalence. We are also tacitly working over a small, full subcategory of

$(Sm|_S)_{Nis}$ consisting of objects of size at most some fixed infinite cardinal, so that the statement of E7 makes sense.

Up to isomorphism, a subobject of a constant simplicial presheaf must be constant, so that the bounded cofibration condition E7 for simplicial presheaves implies a bounded cofibration condition for ordinary presheaves on $(Sm|_S)_{Nis}$. The other axioms E1 – E6 for the class of cofibrations and motivic weak equivalences in the presheaf category are trivial consequences of the corresponding results for simplicial presheaves. It follows that a map $p : X \rightarrow Y$ of presheaves is a fibration if and only if it has the right lifting property with respect to all λ -bounded cofibrations which are motivic equivalences — the argument appears in the proof of Theorem 1.1 of [4]. Continuing in that vein, a transfinite small object argument then implies that every map $g : X \rightarrow Y$ has a factorization

$$\begin{array}{ccc} X & \xrightarrow{j} & Z \\ & \searrow g & \downarrow p \\ & & Y \end{array}$$

such that p is a fibration, and j is a motivic weak equivalence and a cofibration.

Write L_U^* for the free presheaf on a section over U . Then I claim that the presheaf map $p : X \rightarrow Y$ is a fibration and a motivic weak equivalence if it has the right lifting property with respect to all inclusions $A \subset L_U^*$. A map p having this lifting property has the right lifting property with respect to all inclusions, so it is a fibration. The induced map $p_* : S(X) \rightarrow S(Y)$ has the right lifting property with respect to all cofibrations, by an adjointness argument and the fact that realization preserves cofibrations. The map p_* is therefore a fibration and a motivic weak equivalence of simplicial presheaves. The canonical map $\eta : X \rightarrow S(X)$ is a motivic weak equivalence of simplicial presheaves, so the original map $p : X \rightarrow Y$ must also be a motivic weak equivalence of presheaves. A transfinite small object argument then implies that every map $g : X \rightarrow Y$ of presheaves has a factorization

$$\begin{array}{ccc} X & \xrightarrow{i} & W \\ & \searrow g & \downarrow q \\ & & Y \end{array}$$

where i is a cofibration and q is both a fibration and a motivic weak equivalence.

We have proved the factorization axiom CM5. The style of its proof further implies, in a standard way, that every map which is a fibration and a motivic weak equivalence is a retract of a map which has the right lifting property with respect to all cofibrations, and therefore has the same right lifting property. The axiom CM4 follows. The other closed model axioms are trivial to verify. The simplicial model axiom SM7 is a consequence of the corresponding axiom for simplicial presheaves, together with part 3) of Lemma B.1.

To show that motivic weak equivalences of presheaves are stable under pullback along fibrations, it suffices to observe that the singular functor preserves and reflects motivic weak equivalences, in addition to preserving fibrations. The pullback part of the properness assertion therefore follows from the corresponding assertion for simplicial presheaves. The pushout part is a more direct consequence of the statement for simplicial presheaves.

To prove 2), note that the singular and realization functors both preserve motivic weak equivalences, and hence induce functors

$$S : \text{Ho}(\text{Pre}(Sm|_S)_{Nis}) \rightleftarrows \text{Ho}(\mathbf{SPre}(Sm|_S)_{Nis}) : |\cdot|.$$

To show that these functors give an equivalence of categories, it suffices to show that the canonical map $\eta : X \rightarrow S|X|$ is a motivic equivalence for all simplicial presheaves X . Then the map $S\epsilon : S|S(Y)| \rightarrow S(Y)$ would be a motivic weak equivalence for all presheaves Y by a triangle identity, and so $\epsilon : |S(Y)| \rightarrow Y$ would be a motivic weak equivalence since the singular functor reflects motivic weak equivalences.

If X is a constant simplicial presheaf, then the canonical map $\eta : X \rightarrow S|X|$ is isomorphic to the map $\eta : X \rightarrow S(X)$, since $X \cong |X|$ in this case.

Recall that

$$S(Y)_n(U) = \mathbf{Hom}(\mathbb{A}^n, Y)(U) \cong Y(\mathbb{A}^n \times U)$$

for all presheaves Y . It follows that the singular functor preserves all colimits in presheaves and hence in simplicial presheaves. In other words, the singular functor satisfies a very strong excision property.

Every simplicial presheaf X is a coend for the morphisms $X_n \times \Delta^n \rightarrow X$, and the skeletal filtration $\text{sk}_r X$ is defined by pushouts of cofibrations

$$\begin{array}{ccc} (s_{[r]}X_r \times \Delta^{r+1}) \cup (X_{r+1} \times \partial\Delta^{r+1}) & \longrightarrow & \text{sk}_r X \\ \downarrow & & \downarrow \\ X_{r+1} \times \Delta^{r+1} & \longrightarrow & \text{sk}_{r+1} X \end{array}$$

Here, $s_{[r]}X_r$ is the degenerate part of X_{r+1} . More generally, define

$$s_{[k]}X_r = \bigcup_{i=0}^r s_i(X_r) \subset X_{r+1},$$

and observe that there are pushout of cofibration diagrams

$$\begin{array}{ccc} s_{[k]}X_{p-1} & \xrightarrow{s_{k+1}} & s_{[k]}X_p \\ \downarrow & & \downarrow \\ X_p & \xrightarrow{s_{k+1}} & s_{[k+1]}X_p \end{array}$$

for all p and k that make sense. The composite functor $X \mapsto S|X|$ preserves all colimits and hence preserves the skeletal filtration for X in the sense that both of the above species of diagrams are taken to pushouts of cofibrations. On account of properness for the motivic model structure for simplicial presheaves, it therefore suffices to show that the maps

$$X_r \times \Delta^r \rightarrow S|X_r \times \Delta^r|$$

are motivic weak equivalences. But the projections $X_r \times \Delta^r \rightarrow X_r$ are motivic weak equivalences and the composite $S|\cdot|$ preserves motivic weak equivalences, so the claim reduces to the constant case. \square

Here is a corollary of the proof of Theorem B.4:

COROLLARY B.5. *Suppose that $g : X \rightarrow Y$ is a map of simplicial presheaves such that every map $g : X_n \rightarrow Y_n$ is a motivic weak equivalence of presheaves. Then g is a motivic weak equivalence of simplicial presheaves.*

Say that a map of sheaves $g : X \rightarrow Y$ on the Nisnevich site $(Sm|_S)_{Nis}$ is a *motivic weak equivalence* if the associated map of constant simplicial sheaves (or presheaves) is a motivic weak equivalence. A *cofibration* of sheaves is just an inclusion, and a map of simplicial sheaves is a *motivic fibration* if it has the right lifting property with respect to all maps which are simultaneously cofibrations and motivic weak equivalences of simplicial sheaves.

THEOREM B.6. *With these definitions, we have the following:*

- 1) *The category $\text{Shv}(Sm|_S)_{Nis}$ of sheaves on the smooth Nisnevich site of a Noetherian scheme S of finite dimension satisfies the axioms for a proper closed simplicial model category.*
- 2) *The singular and realization functors determine an adjoint equivalence of motivic homotopy categories*

$$\text{Ho}(\text{Shv}(Sm|_S)_{Nis}) \simeq \text{Ho}(\mathbf{S} \text{Shv}(Sm|_S)_{Nis}).$$

- 3) *The associated sheaf functor determines an adjoint equivalence of motivic homotopy categories*

$$\text{Ho}(\text{Pre}(Sm|_S)_{Nis}) \simeq \text{Ho}(\text{Shv}(Sm|_S)_{Nis}).$$

Proof. For 1), note that a map $g : X \rightarrow Y$ of sheaves is a motivic equivalence (respectively cofibration) if and only if is a motivic equivalence (respectively cofibration) of presheaves. The associated sheaf map $A \rightarrow \hat{A}$ is a local isomorphism, and hence a motivic weak equivalence of presheaves. It follows that the classes of motivic weak equivalences and cofibrations of sheaves satisfy the axioms E1 – E7 involved in the proof of Theorem B.4, and then the closed

model structure for the sheaf category is a formal consequence, just as before. Properness is an easy consequence of properness for the presheaf category.

In 2), the singular functor

$$S : \mathrm{Shv}(Sm|_S)_{Nis} \rightarrow \mathbf{S} \mathrm{Shv}(Sm|_S)_{Nis}$$

is defined as for presheaves, and so it preserves and reflects motivic weak equivalences. The simplicial sheaf realization $|X|$ of a simplicial sheaf X is the associated sheaf of the presheaf level realization, so that the map $\eta : X \rightarrow S|X|$ is a motivic weak equivalence, on account of the fact that we know the corresponding statement for simplicial presheaves. The adjoint equivalence of homotopy categories then follows just as in the presheaf case.

Statement 3) is obvious. \square

REFERENCES

- [1] A. K. Bousfield and V. K. A. M. Gugenheim, *On PL De Rham theory and rational homotopy type*, Memoirs AMS 179, no. 8 (1976).
- [2] A. K. Bousfield and E. M. Friedlander, *Homotopy theory of Γ -spaces, spectra, and bisimplicial sets*, Springer Lecture Notes in Math. 658 (1978), 80–130.
- [3] A. K. Bousfield and D. M. Kan, *Homotopy Limits, Completions and Localizations*, Lecture Notes in Math., 304, Springer-Verlag, Berlin-Heidelberg-New York (1972).
- [4] P. G. Goerss and J. F. Jardine, *Localization theories for simplicial presheaves*, Can. J. Math. 50(5) (1998), 1048–1089.
- [5] P. G. Goerss and J. F. Jardine, *Simplicial Homotopy Theory*, Progress in Math., Vol. 174, Birkäuser, Berlin-Basel-Boston (1999).
- [6] M. Hovey, *Spectra and symmetric spectra in general model categories*, Preprint (2000).
- [7] M. Hovey, B. Shipley and J. Smith, *Symmetric spectra*, J. Amer. Math. Soc 13 (2000), 149–208.
- [8] J. F. Jardine, *On the homotopy groups of algebraic groups*, J. Algebra 81 (1983), 180–201.
- [9] J. F. Jardine, *Simplicial presheaves*, J. Pure Applied Algebra 47 (1987), 35–87.
- [10] J. F. Jardine, *Stable homotopy theory of simplicial presheaves*, Can. J. Math 39 (1987), 733–747.
- [11] J. F. Jardine, *Generalized Etale Cohomology Theories*, Progress in Math., Vol. 146, Birkhäuser, Basel-Boston-Berlin (1997).
- [12] J. F. Jardine, *Boolean localization, in practice*, Doc. Math. 1 (1996), 245–275.
- [13] J. F. Jardine, *Presheaves of symmetric spectra*, J. Pure Applied Algebra 150 (2000), 137–154.
- [14] F. Morel and V. Voevodsky, *\mathbb{A}^1 -homotopy theory of schemes*, Preprint (1998).
- [15] Y. A. Nisnevich, *The completely decomposed topology on schemes and associated descent spectral sequences in algebraic K-theory*, Algebraic K-Theory: Connections with Geometry and Topology, NATO ASI Series C, Vol. 279, Kluwer, Dordrecht (1989), 241–342.
- [16] V. Voevodsky, *The Milnor Conjecture*, Preprint (1996).
- [17] V. Voevodsky, *\mathbb{A}^1 -homotopy theory*, Doc. Math. ICM Volume I (1998), 417–442.
- [18] V. Voevodsky, *Voevodsky’s Seattle lectures: K-theory and motivic cohomology*, Algebraic K-theory (Seattle, WA, 1997), Proc. Symp. Pure Math. 67, AMS, Providence (1999), 283–303.
- [19] V. Voevodsky, *Open problems in the motivic stable homotopy theory, I*, Preprint (2000).

C INDEX

- algebraic telescope 503
- bonding maps
 - S^1/\mathbb{G}_m -bispectra..... 489
 - T -bispectra..... 523
 - T -spectra 465
- bounded cofibration condition
 - 466, 481, 482
- cd -excision 457
 - stable..... 458
- cofibration
 - presheaves 545
 - sheaves 549
 - simplicial presheaves 451
 - simplicial sheaves 452
 - T -spectra 465
- elementary cartesian square 457
- elementary f -trivial cofibration .. 537
- empty scheme..... 451
- evaluation map..... 459, 500
- fake suspension..... 501, 502
- f -equivalence 454
- f -fibration 455
- flasque map 461
- free
 - symmetric sequence..... 506
 - symmetric T -spectrum..... 507
- function complex..... 452
- global fibration..... 451
- injective fibration
 - symmetric T -spectra 507
 - T -spectra 465
- internal hom complex 459
- layer filtration..... 496
- level cofibration
 - S^1/\mathbb{G}_m -bispectra..... 491
 - symmetric S^1 -spectra 532
 - symmetric T -spectra 505
 - T -spectra 465
- level equivalence
 - pointwise 506
 - S^1/\mathbb{G}_m -bispectra..... 491
 - symmetric S^1 -spectra 532
 - symmetric T -spectra..... 505
 - T -bispectra 524
 - T -spectra..... 465
- level fibration
 - S^1/\mathbb{G}_m -bispectra..... 491
 - symmetric S^1 -spectra 532
 - T -bispectra 524
 - T -spectra..... 465
- local weak equivalence..... 451
- long exact sequence
 - cofibre sequence 486, 492
 - fibre sequence..... 486, 491
- mapping cylinder..... 463
- model
 - controlled fibrant
 - 456, 467, 480, 506, 533
 - globally fibrant 451
 - injective, T -spectra 467
 - injective stably fibrant 509
 - level fibrant, T -spectra 467
 - stably fibrant, T -spectra 493
- motivic fibration
 - presheaves 545
 - sheaves 549
 - simplicial presheaves 451
 - simplicial sheaves 452
- motivic homotopy theory 451
- motivic stable category..... 473
- motivic weak equivalence
 - presheaves 545
 - sheaves 549
 - simplicial presheaves 451
 - simplicial sheaves 452
- Nisnevich descent
 - stable..... 458
 - unstable 457
- pointwise
 - fibration 452
 - weak equivalence..... 452
- product, symmetric sequences ... 506
- proper closed model category
 - 452, 540

realization functor.....	542	S^1 -spectra	485
S^1/\mathbb{G}_m -bispectrum.....	489	symmetric S^1 -spectra.....	533
S^1 -bispectrum	535	symmetric T -spectra.....	509
S_t^1	487	T -bispectra	525
shift functor.....	501	T -spectra.....	470
symmetric T -spectra	510, 513	stable fibration	
T -spectra	470, 488	symmetric S^1 -spectra.....	533
shuffle permutation $c_{p,q}$	495	symmetric T -spectra.....	508
simplicial presheaf		T -spectra.....	470
α -bounded.....	454	stable homotopy groups.....	485
compact	467	bigraded.....	490
flasque.....	461	weighted.....	488
f -local.....	454	stably fibrant	
motivic fibrant.....	451, 460	T -bispectrum.....	526
motivic flasque.....	467	suspension	
singular functor.....	542	functor	483
SM7, expanded.....	459	functor, fake.....	470
smash product	446, 517	T -bispectrum.....	526
sphere T -spectrum	504	symmetric S^1 -spectrum	532
stabilization functor		symmetric sequence.....	506
$Q_T X$	470	symmetric T -spectrum	504
$Q_T^\Sigma Z$	511	mapping.....	521
$QX = Q_{S^1} X$	485	symmetrization functor V	507
$Q^\Sigma X = Q_{S^1}^\Sigma X$	533	T -bispectrum	523
stable cofibration		T -loops spectrum	469
symmetric S^1 -spectra	534	fake.....	469
symmetric T -spectra	516	T -spectrum	464
stable equivalence		stably fibrant.....	470
local.....	483		

J. F. Jardine
 Department of Mathematics
 Univ. of Western Ontario
 London, Ontario N6A 5B7
 Canada
 jardine@uwo.ca

A MODULAR COMPACTIFICATION
OF THE GENERAL LINEAR GROUP

IVAN KAUSZ

Received: June 2, 2000

Communicated by Peter Schneider

ABSTRACT. We define a certain compactification of the general linear group and give a modular description for its points with values in arbitrary schemes. This is a first step in the construction of a higher rank generalization of Gieseker's degeneration of moduli spaces of vector bundles over a curve. We show that our compactification has similar properties as the "wonderful compactification" of algebraic groups of adjoint type as studied by de Concini and Procesi. As a byproduct we obtain a modular description of the points of the wonderful compactification of PGL_n .

1991 Mathematics Subject Classification: 14H60 14M15 20G

Keywords and Phrases: moduli of vector bundles on curves, modular compactification, general linear group

1. INTRODUCTION

In this paper we give a modular description of a certain compactification KGL_n of the general linear group GL_n . The variety KGL_n is constructed as follows: First one embeds GL_n in the obvious way in the projective space which contains the affine space of $n \times n$ matrices as a standard open set. Then one successively blows up the closed subschemes defined by the vanishing of the $r \times r$ minors ($1 \leq r \leq n$), along with the intersection of these subschemes with the hyperplane at infinity.

We were led to the problem of finding a modular description of KGL_n in the course of our research on the degeneration of moduli spaces of vector bundles. Let me explain in some detail the relevance of compactifications of GL_n in this context.

Let B be a regular integral one-dimensional base scheme and $b_0 \in B$ a closed point. Let $C \rightarrow B$ be a proper flat family of curves over B which is smooth outside b_0 and whose fibre C_0 at b_0 is irreducible with one ordinary double point $p_0 \in C_0$. Let $\tilde{C}_0 \rightarrow C_0$ be the normalization of C_0 and let $p_1, p_2 \in \tilde{C}_0$

the two points lying above the singular point p_0 . Thus the situation may be depicted as follows:

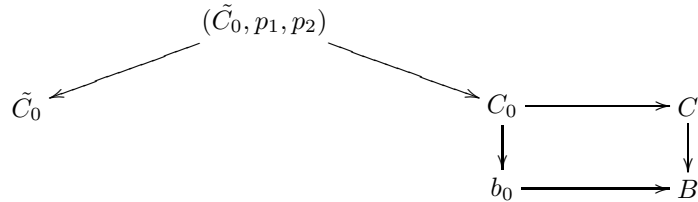

where the left arrow means “forgetting the points p_1, p_2 ”. There is a corresponding diagram of moduli-functors of vector bundles (v.b.) of rank n :

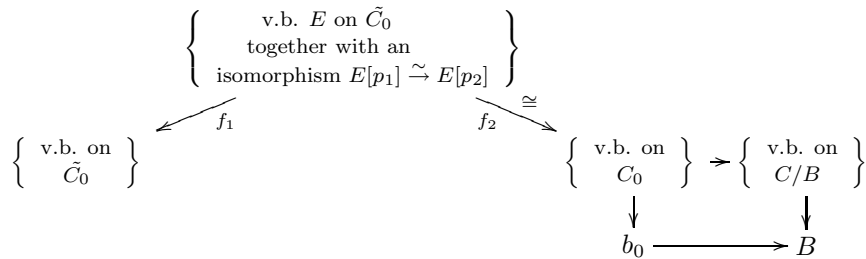

where $E[p_i]$ denotes the fibre of E at the point p_i (cf. section 3 below). The morphism f_1 is “forgetting the isomorphism between the fibres” and f_2 is “gluing together the fibres at p_1 and p_2 along the given isomorphism”. The square on the right is the inclusion of the special fibre. It is clear that f is a locally trivial fibration with fibre Gl_n . Consequently, f_1 is not proper and thus $\{\text{v.b. on } C/B\}$ is not proper over B . It is desirable to have a diagram (*):

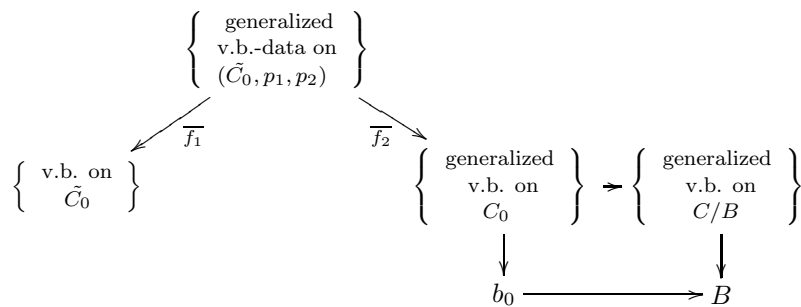

where the functors of “generalized” objects contain the original ones as open subfunctors and where $\{\text{generalized v.b. on } C/B\}$ is proper over B or at least satisfies the existence part of the valuative criterion for properness. The motivation is that such a diagram may help to calculate cohomological invariants of $\{\text{v.b. on } Y\}$ (Y a smooth projective curve) by induction on the genus of Y

(notice that the genus of \tilde{C}_0 is one less than the genus of the generic fibre of C/B).

In the current literature there exist two different approaches for the construction of diagram (*). In the first approach the “generalized v.b.” on C_0 are torsion-free sheaves (cf. [S1], [F], [NR], [Sun]). The second approach is by Gieseker who considered only the rank-two case (cf. [G]). Here the “generalized v.b.” on C_0 are certain vector bundles on C_0, C_1 or C_2 , where C_i is built from C_0 by inserting a chain of i copies of the projective line at p_0 . (Cf. also [Tei] for a discussion of the two approaches). Of course, this is only a very rough picture of what is going on in these papers since I do not mention concepts of stability for the various objects nor the representability of the functors by varieties or by algebraic stacks.

In both approaches the morphism $\overline{f_2}$ is the normalization morphism (at least on the complement of a set of small dimension) and $\overline{f_1}$ is a locally trivial fibration with fibre a compactification of Gl_n . In the torsion-free sheaves approach this compactification is $Gr(2n, n)$, the grassmanian of n -dimensional subspaces of a $2n$ -dimensional vector space. In Gieseker’s construction the relevant compactification of Gl_2 is KGl_2 . An advantage of Gieseker’s construction is that in contrast to the torsion-free sheaves approach, the space {generalized v.b. on C/B } is regular and its special fibre over b_0 is a divisor with normal crossings.

Very recently, Nagaraj and Seshadri have generalized Gieseker’s construction of the right part of diagram (*), i.e. the diagram

$$\begin{array}{ccc} \left\{ \begin{array}{c} \text{generalized} \\ \text{v.b. on} \\ C_0 \end{array} \right\} & \longrightarrow & \left\{ \begin{array}{c} \text{generalized} \\ \text{v.b. on} \\ C/B \end{array} \right\} \\ \downarrow & & \downarrow \\ b_0 & \longrightarrow & B \end{array}$$

to arbitrary rank n (cf. [NS], [S2]). Nagaraj’s and Seshadri’s “generalized vector bundles” on C_0 are certain equivalence classes of vector bundles on one of the curves C_0, \dots, C_n , whose push-forward to C_0 are stable torsion free sheaves.

Without worrying about stability I have recently (and independently from Nagaraj and Seshadri) constructed the full diagram (*) at least at the level of functors (details will appear in a forthcoming paper) and I have reasons to believe that the fibres of the corresponding morphism $\overline{f_1}$ should be represented by KGl_n . The present paper is the first step in the proof of this fact.

The compactification KGl_n of Gl_n has properties similar to those of the “wonderful compactification” of algebraic groups of adjoint type as studied by De Concini and Procesi (cf. [CP]). Namely:

1. The group $Gl_n \times Gl_n$ acts on KGl_n , extending the operation of $Gl_n \times Gl_n$ on Gl_n induced by right and left multiplication (cf. 5.6).
2. The complement of Gl_n in KGl_n is a divisor with normal crossings with irreducible components Y_i, Z_j ($i, j \in \{0, \dots, n - 1\}$) (cf. 4.2).

3. The orbit closures of the operation of $\mathrm{Gl}_n \times \mathrm{Gl}_n$ on KGl_n are precisely the intersections $Y_I \cap Z_J$, where I, J are subsets of $\{0, \dots, n - 1\}$ with $\min(I) + \min(J) \geq n$ and where $Y_I := \bigcap_{i \in I} Y_i$, $Z_J := \bigcap_{j \in J} Z_j$ (cf. 9.4).
4. For each I, J as above there exists a natural mapping from $Y_I \cap Z_J$ to the product of two flag varieties. This mapping is a locally trivial fibration with standard fibre a product of copies of $\overline{\mathrm{PGl}}_{n_k}$ (the wonderful compactification of PGl_{n_k}) for some $n_k \geq 1$ and of one copy of KGl_m for some $m \geq 0$ (cf. 9.3).

Our main theorem 5.5 says that KGl_n parametrizes what we call “generalized isomorphisms” from the trivial bundle of rank n to itself. A generalized isomorphism between vector bundles E and F is by definition a diagram

$$E = E_0 \overset{\otimes}{\leftarrow} E_1 \overset{\otimes}{\leftarrow} E_2 \cdots E_{n-1} \overset{\otimes}{\leftarrow} E_n \overset{\otimes}{\rightsquigarrow} F_n \overset{\otimes}{\rightarrow} F_{n-1} \cdots F_2 \overset{\otimes}{\rightarrow} F_1 \overset{\otimes}{\rightarrow} F_0 = F$$

with certain properties, where the E_i and F_j are vector bundles of the same rank as E and F and where the arrow $\overset{\otimes}{\rightarrow}$ indicates a morphism of the source into the target tensored with a line bundle to be specified. Cf. 5.2 for a precise definition.

The wonderful compactification $\overline{\mathrm{PGl}}_n$ of PGl_n is contained as an orbit closure in KGl_n , in fact $Y_0 \cong \overline{\mathrm{PGl}}_n$. Therefore theorem 5.5 implies a modular description of $\overline{\mathrm{PGl}}_n$. One of the reasons why I decided to publish the present paper separately from my investigations on the degeneration of moduli spaces of vector bundles on curves is the fact that $\overline{\mathrm{PGl}}_n$ has been quite extensively studied in the past (cf. [Lak1] for a historical overview and also the recent paper [Tha2]). Although some effort has been made to find a modular description for it, up to now only partial results in this direction have been obtained (cf. [V], [Lak2], [TK]). In section 8 we explain the connection of these results with ours. Recently Lafforgue has used $\overline{\mathrm{PGl}}_n$ to compactify the stack of Drinfeld’s shtukas (cf. [Laf1], [Laf2]).

Sections 4 and 5 contain the main definitions: In section 4 we give the construction of KGl_n and in section 5 we define the notion of generalized isomorphisms. At the end of section 5 we state our main theorem 5.5. Its proof is given in sections 6 and 7. In section 8 we define complete collineations and compare our notion with the one given by previous authors, in section 9 we study the orbit closures of the operation of $\mathrm{Gl}_n \times \mathrm{Gl}_n$ on KGl_n and in section 10 we define an equivariant morphism of KGl_n onto the Grassmannian compactification of Gl_n and compute its fibres.

My interest in degeneration of moduli spaces of bundles on curves has been greatly stimulated by a workshop on conformal blocks and the Verlinde formula, organized in March 1997 by the physicists Jürgen Fuchs and Christoph Schweigert at the Mathematisches Forschungsinstitut in Oberwolfach. Part of this work has been prepared during a stay at the Mathematical Institute of the University of Oxford. Its hospitality is gratefully acknowledged. Thanks are due to Daniel Huybrechts for mentioning to me the work of Thaddeus, to M. Thaddeus himself for sending me a copy of part of his thesis and to M.

Rapoport for drawing my attention to the work of Laksov and Lafforgue. I would also like to thank Uwe Jannsen for his constant encouragement.

2. AN ELEMENTARY EXAMPLE

This section is not strictly necessary for the comprehension of what follows. But since the rest of the paper is a bit technical, I felt that a simple example might facilitate its understanding.

Let A be a discrete valuation ring, K its field of fractions, \mathfrak{m} its maximal ideal, $t \in \mathfrak{m}$ a local parameter and $k := A/\mathfrak{m}$ the residue class field of A . Let E and F be two free A -modules of rank n and let $\varphi_K : E_K \xrightarrow{\sim} F_K$ be an isomorphism between the generic fibers $E_K := E \otimes_A K$ and $F_K := F \otimes_A K$ of E and F . We can choose A -bases of E and F such that φ_K has the matrix presentation $\text{diag}(t^{m_1}, \dots, t^{m_n})$ with respect to these bases, where $m_i \in \mathbb{Z}$ and $m_1 \leq \dots \leq m_n$. Now let $a_0 := 0 =: b_0$ and for $1 \leq i \leq n$ set $a_i := -\min(0, m_{n+1-i})$ and $b_i := \max(0, m_i)$. Note that we have

$$0 = a_0 = \dots = a_{n-l} \leq a_{n-l+1} \leq \dots \leq a_n$$

$$\text{and } 0 = b_0 = \dots = b_l \leq b_{l+1} \leq \dots \leq b_n$$

for some $l \in \{0, \dots, n\}$. Let

$$E_n \subseteq \dots \subseteq E_1 \subseteq E_0 := E \quad \text{and} \quad F_n \subseteq \dots \subseteq F_1 \subseteq F_0 := F$$

be the A -submodules defined by

$$E_{i+1} := \begin{bmatrix} t^{a_{i+1}-a_i} \mathbb{I}_{n-i} & 0 \\ & \mathbb{I}_i \end{bmatrix} E_i \quad , \quad F_{i+1} := \begin{bmatrix} \mathbb{I}_i & 0 \\ 0 & t^{b_{i+1}-b_i} \mathbb{I}_{n-i} \end{bmatrix} F_i \quad ,$$

where \mathbb{I}_i denotes the $i \times i$ unit matrix. Then φ_K induces an isomorphism $\varphi : E_n \xrightarrow{\sim} F_n$ and we have the natural injections

$$E_i \hookrightarrow \mathfrak{m}^{a_i-a_{i+1}} E_{i+1} \quad , \quad E_i \hookrightarrow E_{i+1}$$

$$F_{i+1} \hookrightarrow F_i \quad , \quad \mathfrak{m}^{b_i-b_{i+1}} F_{i+1} \hookrightarrow F_i \quad .$$

Observe that the compositions $E_{i+1} \hookrightarrow E_i \hookrightarrow \mathfrak{m}^{a_i-a_{i+1}} E_{i+1}$ and $E_i \hookrightarrow \mathfrak{m}^{a_i-a_{i+1}} E_{i+1} \hookrightarrow \mathfrak{m}^{a_i-a_{i+1}} E_i$ are both the injections induced by the inclusion $A \hookrightarrow \mathfrak{m}^{a_i-a_{i+1}}$. Furthermore, if $a_i - a_{i+1} < 0$ then the morphism of k -vectorspaces $E_{i+1} \otimes k \rightarrow E_i \otimes k$ is of rank i and the sequence

$$E_{i+1} \otimes k \rightarrow E_i \otimes k \rightarrow (\mathfrak{m}^{a_i-a_{i+1}} E_{i+1}) \otimes k \rightarrow (\mathfrak{m}^{a_i-a_{i+1}} E_i) \otimes k$$

is exact. This shows that the tuple

$$(\mathfrak{m}^{a_i-a_{i+1}}, 1 \in \mathfrak{m}^{a_i-a_{i+1}}, E_{i+1} \hookrightarrow E_i, \mathfrak{m}^{a_i-a_{i+1}} E_{i+1} \hookrightarrow E_i, i)$$

is what we call a “bf-morphism” of rank i (cf. definition 5.1). Observe now that if $a_i - a_{i+1} < 0$ and (f, g) is one of the following two pairs of morphisms:

$$E \otimes k \xrightarrow{f} (\mathfrak{m}^{-a_i} E_i) \otimes k \xrightarrow{g} (\mathfrak{m}^{-a_{i+1}} E_{i+1}) \otimes k \quad ,$$

$$E_i \otimes k \xleftarrow{g} E_{i+1} \otimes k \xleftarrow{f} E_n \otimes k \quad ,$$

then $\text{im}(g \circ f) = \text{im}(g)$. The above statements hold true also if we replace the E_i -s by the F_i -s and the a_i -s by the b_i -s. Observe finally that in the diagram

$$\begin{array}{ccccccc}
 & & & & 0 & & \\
 & & & & \downarrow & & \\
 & & & & \ker(E_n \otimes k \rightarrow E_0 \otimes k) & & \\
 & & & & \downarrow & \searrow & \\
 0 > \ker(F_n \otimes k \rightarrow F_0 \otimes k) & \longrightarrow & E_n \otimes k & \cong & F_n \otimes k & \longrightarrow & \text{im}(F_n \otimes k \rightarrow F_0 \otimes k) > 0 \\
 & \searrow & & & \downarrow & & \\
 & & & & \text{im}(E_n \otimes k \rightarrow E_0 \otimes k) & & \\
 & & & & \downarrow & & \\
 & & & & 0 & &
 \end{array}$$

the oblique arrows are injections.

All these properties are summed up in the statement that the tuple

$$\begin{aligned}
 \Phi & := ((\mathfrak{m}^{b_i-b_{i+1}}, 1), (\mathfrak{m}^{a_i-a_{i+1}}, 1), E_i \hookrightarrow \mathfrak{m}^{a_i-a_{i+1}} E_{i+1}, E_i \hookrightarrow E_{i+1}, \\
 & \quad F_{i+1} \hookrightarrow F_i, \mathfrak{m}^{b_i-b_{i+1}} F_{i+1} \hookrightarrow F_i \quad (0 \leq i \leq n-1), \varphi : E_n \xrightarrow{\sim} F_n)
 \end{aligned}$$

is a generalized isomorphism from E to F in the sense of definition 5.2, where for $a \leq 0$ we consider \mathfrak{m}^a as an invertible A -module with global section $1 \in \mathfrak{m}^a$. Observe that Φ does not depend on our choice of the bases for E and F . Indeed, it is well-known that the sequence (m_1, \dots, m_n) is independent of such a choice and it is easy to see that $E_n = \varphi_K^{-1}(F) \cap E$, $F_n = \varphi_K(E_n)$ and

$$E_i = E_n + \mathfrak{m}^{a_i} E \quad , \quad F_i = F_n + \mathfrak{m}^{b_i} F$$

for $1 \leq i \leq n-1$, where the $+$ -sign means generation in E_K and F_K respectively. Observe furthermore that by pull-back the generalized isomorphism Φ induces a generalized isomorphism $f^*\Phi$ on a scheme S for every morphism $f : S \rightarrow \text{Spec}(A)$. Of course the morphisms $f^*E_{i+1} \rightarrow f^*E_i$ etc. will be in general no longer injective, but this is not required in the definition.

3. NOTATIONS

We collect some less common notations, which we will use freely in this paper:

- For two integers $a \leq b$ we sometimes denote by $[a, b]$ the set $\{c \in \mathbb{Z} \mid a \leq c \leq b\}$.
- For a $n \times n$ -matrix with entries a_{ij} in some ring, and for two subsets A and B of cardinality r of $\{1, \dots, n\}$, we will denote by $\det_{AB}(a_{ij})$ the determinant of the $r \times r$ -matrix $(a_{ij})_{i \in A, j \in B}$.
- For a scheme X we will denote by \mathcal{K}_X the sheaf of total quotient rings of \mathcal{O}_X .

- For a scheme X , a coherent sheaf \mathcal{E} on X and a point $x \in X$, we denote by $\mathcal{E}[x]$ the fibre $\mathcal{E} \otimes_{\mathcal{O}_X} \kappa(x)$ of \mathcal{E} at x .
- For $n \in \mathbb{N}$, the symbol S_n denotes the symmetric group of permutations of the set $\{1, \dots, n\}$.

4. CONSTRUCTION OF THE COMPACTIFICATION

Let $X^{(0)} := \text{Proj } \mathbb{Z}[x_{00}, x_{ij} \ (1 \leq i, j \leq n)]$. We define closed subschemes

$$\begin{array}{ccccccc}
 Y_0^{(0)} & \hookrightarrow & Y_1^{(0)} & \hookrightarrow & \cdots & \hookrightarrow & Y_{n-1}^{(0)} \\
 & & \downarrow & & & & \downarrow \\
 & & Z_{n-1}^{(0)} & \hookrightarrow & \cdots & \hookrightarrow & Z_1^{(0)} \hookrightarrow Z_0^{(0)}
 \end{array}$$

of $X^{(0)}$, by setting $Y_r^{(0)} := V^+(\mathcal{I}_r^{(0)})$, $Z_r^{(0)} := V^+(\mathcal{J}_r^{(0)})$, where $\mathcal{I}_r^{(0)}$ is the homogenous ideal in $\mathbb{Z}[x_{00}, x_{ij} \ (1 \leq i, j \leq n)]$, generated by all $(r+1) \times (r+1)$ -subdeterminants of the matrix $(x_{ij})_{1 \leq i, j \leq n}$, and where $\mathcal{J}_r^{(0)} = (x_{00}) + \mathcal{I}_{n-r}^{(0)}$ for $0 \leq r \leq n-1$. For $1 \leq k \leq n$ let the scheme $X^{(k)}$ together with closed subschemes $Y_r^{(k)}, Z_r^{(k)} \subset X^{(k)}$ ($0 \leq r \leq n-1$) be inductively defined as follows:

$X^{(k)} \rightarrow X^{(k-1)}$ is the blowing up of $X^{(k-1)}$ along the closed subscheme $Y_{k-1}^{(k-1)} \cup Z_{n-k}^{(k-1)}$. The subscheme $Y_{k-1}^{(k)} \subset X^{(k)}$ (respectively $Z_{n-k}^{(k)} \subset X^{(k)}$) is the inverse image of $Y_{k-1}^{(k-1)}$ (respectively of $Z_{n-k}^{(k-1)}$) under the morphism $X^{(k)} \rightarrow X^{(k-1)}$, and for $r \neq k-1$ (respectively $r \neq n-k$) the subscheme $Y_r^{(k)} \subset X^{(k)}$ (respectively of $Z_r^{(k)} \subset X^{(k)}$) is the complete transform of $Y_r^{(k-1)} \subset X^{(k-1)}$ (respectively $Z_r^{(k-1)} \subset X^{(k-1)}$). We set

$$\text{KGl}_n := X^{(n)} \quad \text{and} \quad Y_r := Y_r^{(n)}, \ Z_r := Z_r^{(n)} \quad (0 \leq r \leq n-1).$$

We are interested in finding a modular description for the compactification KGl_n of $\text{Gl}_n = \text{Spec } \mathbb{Z}[x_{ij}/x_{00} \ (1 \leq i, j \leq n), \det(x_{ij}/x_{00})^{-1}]$. Let $(\alpha, \beta) \in S_n \times S_n$ and set

$$x_{ij}^{(0)}(\alpha, \beta) := \frac{x_{\alpha(i), \beta(j)}}{x_{00}} \quad (1 \leq i, j \leq n) \quad .$$

For $1 \leq k \leq n$ we define elements

$$\begin{array}{ll}
 y_{ji}(\alpha, \beta), \ z_{ij}(\alpha, \beta) & (1 \leq i \leq k, \ i < j \leq n) \\
 x_{ij}^{(k)}(\alpha, \beta) & (k+1 \leq i, j \leq n)
 \end{array}$$

of the function field $\mathbb{Q}(X^{(0)}) = \mathbb{Q}(x_{ij}/x_{00} \ (1 \leq i, j \leq n))$ of $X^{(0)}$ inductively as follows:

$$\begin{aligned}
 y_{ik}(\alpha, \beta) &:= \frac{x_{ik}^{(k-1)}(\alpha, \beta)}{x_{kk}^{(k-1)}(\alpha, \beta)} & (k+1 \leq i \leq n) \quad , \\
 z_{kj}(\alpha, \beta) &:= \frac{x_{kj}^{(k-1)}(\alpha, \beta)}{x_{kk}^{(k-1)}(\alpha, \beta)} & (k+1 \leq j \leq n) \quad , \\
 x_{ij}^{(k)}(\alpha, \beta) &:= \frac{x_{ij}^{(k-1)}(\alpha, \beta)}{x_{kk}^{(k-1)}(\alpha, \beta)} - y_{ik}(\alpha, \beta) z_{kj}(\alpha, \beta) & (k+1 \leq i, j \leq n) \quad .
 \end{aligned}$$

Finally, we set $t_0(\alpha, \beta) := t_0 := x_{00}$ and

$$t_i(\alpha, \beta) := t_0 \cdot \prod_{j=1}^i x_{jj}^{(j-1)}(\alpha, \beta) \quad (1 \leq i \leq n) \quad .$$

Observe, that for each $k \in \{0, \dots, n\}$, we have the following decomposition of the matrix $[x_{ij}/x_{00}]$:

$$\begin{bmatrix} x_{ij} \\ x_{00} \end{bmatrix} = n_\alpha \begin{bmatrix} \begin{array}{c|c} \begin{array}{ccc} \diagup & & \\ & 0 & \\ & & \diagdown \end{array} & \\ \hline y_{ij}(\alpha, \beta) & \\ \hline & \mathbb{I}_{n-k} \end{array} \end{bmatrix} \begin{bmatrix} \frac{t_1(\alpha, \beta)}{t_0} & 0 & \\ \vdots & \vdots & 0 \\ 0 & \frac{t_k(\alpha, \beta)}{t_0} & \\ & 0 & \frac{t_k(\alpha, \beta)}{t_0} [x_{ij}^{(k)}(\alpha, \beta)] \end{bmatrix} \begin{bmatrix} \begin{array}{c|c} \begin{array}{ccc} \diagup & & \\ & z_{ij}(\alpha, \beta) & \\ & & \diagdown \end{array} & \\ \hline 0 & \\ \hline & \mathbb{I}_{n-k} \end{array} \end{bmatrix} n_\beta^{-1}$$

Here, n_α is the permutation matrix associated to α , i.e. the matrix, whose entry in the i -th row and j -th column is $\delta_{i, \alpha(j)}$. For convenience, we define for each $l \in \{0, \dots, n\}$ a bijection $u_l : \{1, \dots, n+1\} \xrightarrow{\sim} \{0, \dots, n\}$, by setting

$$u_l(i) = \begin{cases} i & \text{if } 1 \leq i \leq l \\ 0 & \text{if } i = l+1 \\ i-1 & \text{if } l+2 \leq i \leq n+1 \end{cases}$$

for $1 \leq i \leq n+1$. With this notation, we define for each triple $(\alpha, \beta, l) \in S_n \times S_n \times [0, n]$ polynomial subalgebras $R(\alpha, \beta, l)$ of $\mathbb{Q}(KGl_n) = \mathbb{Q}(X^{(0)})$ together with ideals $\mathcal{I}_r(\alpha, \beta, l)$ and $\mathcal{J}_r(\alpha, \beta, l)$ ($0 \leq r \leq n-1$) of $R(\alpha, \beta, l)$ as follows:

$$\begin{aligned}
 R(\alpha, \beta, l) &:= \mathbb{Z} \left[\frac{t_{u_l(i+1)}(\alpha, \beta)}{t_{u_l(i)}(\alpha, \beta)} \ (1 \leq i \leq n), \ y_{ji}(\alpha, \beta), \ z_{ij}(\alpha, \beta) \ (1 \leq i < j \leq n) \right], \\
 \mathcal{I}_r(\alpha, \beta, l) &:= \left(\frac{t_{u_l(r+2)}(\alpha, \beta)}{t_{u_l(r+1)}(\alpha, \beta)} \right) \text{ if } l \leq r \leq n-1 \text{ and } \mathcal{I}_r(\alpha, \beta, l) := (1) \text{ else,} \\
 \mathcal{J}_r(\alpha, \beta, l) &:= \left(\frac{t_{u_l(n-r+1)}(\alpha, \beta)}{t_{u_l(n-r)}(\alpha, \beta)} \right) \text{ if } n-l \leq r \leq n-1 \text{ and } \mathcal{J}_r(\alpha, \beta, l) := (1) \text{ else.}
 \end{aligned}$$

PROPOSITION 4.1. *There is a covering of KGl_n by open affine pieces $X(\alpha, \beta, l)$ ($(\alpha, \beta, l) \in S_n \times S_n \times [0, n]$), such that $\Gamma(X(\alpha, \beta, l), \mathcal{O}) = R(\alpha, \beta, l)$ (equality as subrings of the function field $\mathbb{Q}(KGl_n)$). Furthermore, for $0 \leq r \leq n-1$ the ideals $\mathcal{I}_r(\alpha, \beta, l)$ and $\mathcal{J}_r(\alpha, \beta, l)$ of $R(\alpha, \beta, l)$ are the defining ideals for the*

closed subschemes $Y_r(\alpha, \beta, l) := Y_r \cap X(\alpha, \beta, l)$ and $Z_r(\alpha, \beta, l) := Z_r \cap X(\alpha, \beta, l)$ respectively.

Proof. We make the blowing-up procedure explicit, in terms of open affine coverings. For each $k \in \{0, \dots, n\}$ we define a finite index set \mathcal{P}_k , consisting of all pairs

$$(p, q) = \left(\begin{bmatrix} p_0 \\ \vdots \\ p_k \end{bmatrix}, \begin{bmatrix} q_0 \\ \vdots \\ q_k \end{bmatrix} \right) \in \{0, \dots, n\}^{k+1} \times \{0, \dots, n\}^{k+1}$$

with the property that $p_i \neq p_j$ and $q_i \neq q_j$ for $i \neq j$ and that $p_i = 0$ for some i , if and only if $q_i = 0$. Observe that for each $k \in \{0, \dots, n\}$ there is a surjection $S_n \times S_n \times \{0, \dots, n\} \rightarrow \mathcal{P}_k$, which maps the triple (α, β, l) to the element

$$(p, q) = \left(\begin{bmatrix} \alpha(\iota_l(1)) \\ \vdots \\ \alpha(\iota_l(k+1)) \end{bmatrix}, \begin{bmatrix} \beta(\iota_l(1)) \\ \vdots \\ \beta(\iota_l(k+1)) \end{bmatrix} \right)$$

of \mathcal{P}_k . (Here we have used the convention that $\alpha(0) := 0$ for any permutation $\alpha \in S_n$). Furthermore, this surjection is in fact a bijection in the case of $k = n$. Let $(p, q) \in \mathcal{P}_k$ and chose an element (α, β, l) in its preimage under the surjection $S_n \times S_n \times \{0, \dots, n\} \rightarrow \mathcal{P}_k$. We define subrings $R^{(k)}(p, q)$ of $\mathbb{Q}(x_{ij}/x_{00} \ (1 \leq i, j \leq n))$ together with ideals $\mathcal{I}_r^{(k)}(p, q), \mathcal{J}_r^{(k)}(p, q) \ (0 \leq r \leq n)$, distinguishing three cases.

First case: $0 \leq l \leq k - 1$

$$R^{(k)}(p, q) := \mathbb{Z} \left[\frac{t_{\iota_l(i+1)}(\alpha, \beta)}{t_{\iota_l(i)}(\alpha, \beta)} \ (1 \leq i \leq k), \ y_{ji}(\alpha, \beta), \ z_{ij}(\alpha, \beta) \ \left(\begin{matrix} 1 \leq i \leq k, \\ i < j \leq n \end{matrix} \right), \right. \\ \left. x_{ij}^{(k)}(\alpha, \beta) \ (k+1 \leq i, j \leq n) \right]$$

$$\mathcal{I}_r^{(k)}(p, q) := \begin{cases} (1) & \text{if } r \in [0, l-1] \\ \left(\frac{t_{\iota_l(r+2)}(\alpha, \beta)}{t_{\iota_l(r+1)}(\alpha, \beta)} \right) & \text{if } r \in [l, k-1] \\ \left(\det_{AB}(x_{ij}^{(k)}(\alpha, \beta)) \ \left(\begin{matrix} A, B \subseteq \{k+1, \dots, n\} \\ \#A = \#B = r+1-k \end{matrix} \right) \right) & \text{if } r \in [k, n-1] \end{cases}$$

$$\mathcal{J}_r^{(k)}(p, q) := \begin{cases} (1) & \text{if } r \in [0, n-l-1] \\ \left(\frac{t_{\iota_l(n-r+1)}(\alpha, \beta)}{t_{\iota_l(n-r)}(\alpha, \beta)} \right) & \text{if } r \in [n-l, n-1] \end{cases}$$

Second case: $l = k$

$$\begin{aligned}
 R^{(k)}(p, q) &:= \mathbb{Z} \left[\frac{t_{l(i+1)}(\alpha, \beta)}{t_{l(i)}(\alpha, \beta)} \ (1 \leq i \leq k), \ y_{ji}(\alpha, \beta), \ z_{ij}(\alpha, \beta) \ \left(\begin{array}{l} 1 \leq i \leq k, \\ i < j \leq n \end{array} \right), \right. \\
 &\quad \left. \frac{t_k(\alpha, \beta)}{t_0} x_{ij}^{(k)}(\alpha, \beta) \ (k+1 \leq i, j \leq n) \right] \\
 \mathcal{I}_r^{(k)}(p, q) &:= \begin{cases} (1) & \text{if } r \in [0, l-1] \\ \left(\det_{AB} \left(\frac{t_k(\alpha, \beta)}{t_0} x_{ij}^{(k)}(\alpha, \beta) \right) \left(\begin{array}{l} A, B \subseteq \{k+1, \dots, n\} \\ \#A = \#B = r+1-k \end{array} \right) \right) & \text{if } r \in [l, n-1] \end{cases} \\
 \mathcal{J}_r^{(k)}(p, q) &:= \begin{cases} (1) & \text{if } r \in [0, n-l-1] \\ \left(\frac{t_{l(n-r+1)}(\alpha, \beta)}{t_{l(n-r)}(\alpha, \beta)} \right) & \text{if } r \in [n-l, n-1] \end{cases}
 \end{aligned}$$

Third case: $k+1 \leq l \leq n$

$$\begin{aligned}
 R^{(k)}(p, q) &:= \mathbb{Z} \left[\frac{t_{l(i+1)}(\alpha, \beta)}{t_{l(i)}(\alpha, \beta)} \ (1 \leq i \leq k), \ \frac{t_0}{t_{k+1}(\alpha, \beta)}, \right. \\
 &\quad \left. y_{ji}(\alpha, \beta), \ z_{ij}(\alpha, \beta) \ \left(\begin{array}{l} 1 \leq i \leq k+1, \\ i < j \leq n \end{array} \right), \ x_{ij}^{(k+1)}(\alpha, \beta) \ (k+2 \leq i, j \leq n) \right] \\
 \mathcal{I}_r^{(k)}(p, q) &:= \begin{cases} (1) & \text{if } r \in [0, k] \\ \left(\det_{AB} \left(x_{ij}^{(k+1)}(\alpha, \beta) \right) \left(\begin{array}{l} A, B \subseteq \{k+2, \dots, n\} \\ \#A = \#B = r-k \end{array} \right) \right) & \text{if } r \in [k+1, n-1] \end{cases} \\
 \mathcal{J}_r^{(k)}(p, q) &:= \begin{cases} \left(\frac{t_0}{t_{k+1}(\alpha, \beta)}, \det_{AB} \left(x_{ij}^{(k+1)}(\alpha, \beta) \right) \left(\begin{array}{l} A, B \subseteq \{k+2, \dots, n\} \\ \#A = \#B = n-r-k \end{array} \right) \right) & \text{if } r \in [0, n-k-1] \\ \left(\frac{t_{l(n-r+1)}(\alpha, \beta)}{t_{l(n-r)}(\alpha, \beta)} \right) & \text{if } r \in [n-k, n-1] \end{cases}
 \end{aligned}$$

Observe that the objects $R^{(k)}(p, q)$, $\mathcal{I}_r^{(k)}(p, q)$, $\mathcal{J}_r^{(k)}(p, q)$ thus defined, depend indeed only on (p, q) and not on the chosen element (α, β, l) . By induction on k one shows that $X^{(k)}$ is covered by open affine pieces $X^{(k)}(p, q)$ ($(p, q) \in \mathcal{P}_k$), such that $\Gamma(X^{(k)}(p, q), \mathcal{O}) = R^{(k)}(p, q)$ (equality as subrings of the function field $\mathbb{Q}(X^{(k)})$), and such that the ideals $\mathcal{I}_r^{(k)}(\alpha, \beta)$ and $\mathcal{J}_r^{(k)}(\alpha, \beta)$ are the defining ideals of the closed subschemes $Y_r^{(k)} \cap X^{(k)}(p, q)$ and $Z_r^{(k)} \cap X^{(k)}(p, q)$ respectively. □

COROLLARY 4.2. *The scheme KGl_n is smooth and projective over $\text{Spec } \mathbb{Z}$ and contains Gl_n as a dense open subset. The complement of Gl_n in KGl_n is the union of the closed subschemes Y_i, Z_i ($0 \leq i \leq n-1$), which is a divisor with normal crossings. Furthermore, we have $Y_i \cap Z_j = \emptyset$ for $i+j < n$.*

Proof. This is immediate from the local description given in 4.1. □

We will now define a certain toric scheme, which will play an important role in the sequel. Let $M := \mathbb{Z}^n$, with canonical basis e_1, \dots, e_n . For $m \in M$ we denote by t^m the corresponding monomial in the ring $\mathbb{Z}[M]$. Furthermore, we write t_i/t_0 for the canonical generator t^{e_i} of $\mathbb{Z}[M]$. Let $N := M^\vee$ be the dual of M with the dual basis $e_1^\vee, \dots, e_n^\vee$. For $0 \leq l \leq n$ let $\sigma_l \subset N_{\mathbb{Q}} := N \otimes \mathbb{Q}$ be

the cone generated by the elements $-\sum_{j=1}^i e_j^\vee$ ($1 \leq i \leq l$) and the elements $\sum_{j=i}^n e_j^\vee$ ($l+1 \leq i \leq n$). In other words:

$$\sigma_l = \sum_{i=1}^l \mathbb{Q}_+ \cdot \left(-\sum_{j=1}^i e_j^\vee \right) + \sum_{i=l+1}^n \mathbb{Q}_+ \cdot \left(\sum_{j=i}^n e_j^\vee \right) .$$

Let Σ be the fan generated by all σ_l ($0 \leq l \leq n$) and let $\tilde{T} := X_\Sigma$ the associated toric scheme (over \mathbb{Z}). See e.g. [Da] for definitions. \tilde{T} is covered by the open sets $\tilde{T}_l := X_{\sigma_l^\vee} = \text{Spec } \mathbb{Z}[t^m \mid (m \in \sigma_l^\vee \cap M)] = \text{Spec } \mathbb{Z}[t_{u_l(i+1)}/t_{u_l(i)} \mid (1 \leq i \leq n)]$. Observe that there are Cartier divisors $Y_{r,\tilde{T}}, Z_{r,\tilde{T}}$ ($0 \leq r \leq n-1$) on \tilde{T} , such that for each $l \in \{0, \dots, n\}$ over the open part $\tilde{T}_l \subset \tilde{T}$,

$$\begin{aligned} Y_{r,\tilde{T}} \text{ is given by the equation } & \begin{cases} 1 & \text{if } 0 \leq r \leq l-1 \\ t_{u_l(r+2)}/t_{u_l(r+1)} & \text{if } l \leq r \leq n-1 \end{cases} \\ Z_{r,\tilde{T}} \text{ is given by the equation } & \begin{cases} 1 & \text{if } 0 \leq r \leq n-l-1 \\ t_{u_l(n-r+1)}/t_{u_l(n-r)} & \text{if } n-l \leq r \leq n-1 \end{cases} \end{aligned}$$

Observe furthermore that $Y_{i,\tilde{T}} \cap Z_{j,\tilde{T}} = \emptyset$ for $i+j < n$ and that for each $r \in \{1, \dots, n\}$, multiplication by t_r/t_0 establishes an isomorphism

$$\mathcal{O}_{\tilde{T}} \left(-\sum_{i=0}^{n-r} Z_{i,\tilde{T}} \right) \xrightarrow{\sim} \mathcal{O}_{\tilde{T}} \left(-\sum_{i=0}^{r-1} Y_{i,\tilde{T}} \right) .$$

LEMMA 4.3. *The toric scheme \tilde{T} together with the “universal” tuple $(\mathcal{O}_{\tilde{T}}(Y_{i,\tilde{T}}), \mathbf{1}_{\mathcal{O}_{\tilde{T}}(Y_{i,\tilde{T}})}, \mathcal{O}_{\tilde{T}}(Z_{i,\tilde{T}}), \mathbf{1}_{\mathcal{O}_{\tilde{T}}(Z_{i,\tilde{T}})})$ ($0 \leq i \leq n-1$), t_r/t_0 ($1 \leq r \leq n$) represents the functor, which to each scheme S associates the set of equivalence classes of tuples*

$$(\mathcal{L}_i, \lambda_i, \mathcal{M}_i, \mu_i \ (0 \leq i \leq n-1), \varphi_r \ (1 \leq r \leq n)) \quad ,$$

where the \mathcal{L}_i and \mathcal{M}_i are invertible \mathcal{O}_S -modules with global sections λ_i and μ_i respectively, such that for $i+j < n$ the zero-sets of λ_i and μ_j do not intersect, and where the φ_r are isomorphisms

$$\bigotimes_{i=0}^{n-r} \mathcal{M}_i^\vee \xrightarrow{\sim} \bigotimes_{i=0}^{r-1} \mathcal{L}_i^\vee .$$

Here two tuples $(\mathcal{L}_i, \lambda_i, \mathcal{M}_i, \mu_i \ (0 \leq i \leq n-1), \varphi_r \ (1 \leq r \leq n))$ and $(\mathcal{L}'_i, \lambda'_i, \mathcal{M}'_i, \mu'_i \ (0 \leq i \leq n-1), \varphi'_r \ (1 \leq r \leq n))$ are called equivalent, if there exist isomorphisms $\mathcal{L}_i \xrightarrow{\sim} \mathcal{L}'_i$ and $\mathcal{M}_i \xrightarrow{\sim} \mathcal{M}'_i$ for $0 \leq i \leq n-1$, such that all the obvious diagrams commute.

Proof. Let S be a scheme and $(\mathcal{L}_i, \lambda_i, \mathcal{M}_i, \mu_i \ (0 \leq i \leq n-1), \varphi_r \ (1 \leq r \leq n))$ a tuple defined over S , which has the properties stated in the lemma. Let us first consider the case, where all the sheaves $\mathcal{L}_i, \mathcal{M}_i$ are trivial and where there exists an $l \in \{0, \dots, n\}$, such that λ_i and μ_j is nowhere vanishing for $0 \leq i < l$ and $0 \leq j < n-l$ respectively. Observe that under these conditions there

exists a unique set of trivializations $\mathcal{L}_i \xrightarrow{\sim} \mathcal{O}_S, \mathcal{M}_i \xrightarrow{\sim} \mathcal{O}_S, (0 \leq i \leq n)$ such that $\lambda_i \mapsto 1$ for $0 \leq i < l, \mu_j \mapsto 1$ for $0 \leq j < n - l$, and such that the diagrams

$$\begin{array}{ccc} \bigotimes_{i=0}^{n-r} \mathcal{M}_i^\vee & \xrightarrow[\sim]{\varphi_r} & \bigotimes_{i=0}^{r-1} \mathcal{L}_i^\vee \\ & \searrow \sim & \swarrow \sim \\ & \mathcal{O}_S & \end{array}$$

commute for $1 \leq r \leq n$. Let $a_\nu \in \Gamma(S, \mathcal{O}_S) (1 \leq \nu \leq n)$ be defined by $\lambda_i \mapsto a_{i+1}$ for $l \leq i \leq n - 1$ and $\mu_j \mapsto a_{n-j}$ for $n - l \leq j \leq n - 1$, and let $f_l : S \rightarrow \tilde{T}_l$ be the morphism defined by $f_l^*(t_{i(\nu+1)}/t_{i(\nu)}) = a_\nu (1 \leq \nu \leq n)$. It is straightforward to check that the induced morphism $f : S \rightarrow \tilde{T}$ does not depend on the chosen number l and that it is unique with the property that the pull-back under f of the universal tuple is equivalent to the given one on S .

Returning to the general case, observe that there is an open covering $S = \cup_k U_k$, such that for each k there exists an l with the property that over U_k all the $\mathcal{L}_i, \mathcal{M}_i$ are trivial and that λ_i and μ_j is nowhere vanishing over U_k for $0 \leq i < l$ and $0 \leq j < n - l$. The above construction shows that there exists a unique morphism $f : S \rightarrow \tilde{T}$ such that for each k the restriction to U_k of the pull-back under f of the universal tuple is equivalent to the restriction to U_k of the given one. Thus it remains only to show that the isomorphisms defining the equivalences over the U_k glue together to give a global equivalence of the pull-back of the universal tuple with the given one. However, this is clear, since it is easy to see that there exists at most one set of isomorphisms $\mathcal{L}_i \xrightarrow{\sim} \mathcal{L}'_i, \mathcal{M}_i \xrightarrow{\sim} \mathcal{M}'_i$ establishing an equivalence between two tuples $(\mathcal{L}_i, \lambda_i, \mathcal{M}_i, \mu_i, \varphi_r)$ and $(\mathcal{L}'_i, \lambda'_i, \mathcal{M}'_i, \mu'_i, \varphi'_r)$. \square

For each pair $(\alpha, \beta) \in S_n \times S_n$ we define the open subset $X(\alpha, \beta) \subseteq \text{KGl}_n$ as the union of the open affines $X(\alpha, \beta, l) (0 \leq l \leq n)$. Let

$$\begin{aligned} U^- &:= \text{Spec } \mathbb{Z}[y_{ji} (1 \leq i < j \leq n)] \quad , \\ U^+ &:= \text{Spec } \mathbb{Z}[z_{ij} (1 \leq i < j \leq n)] \quad . \end{aligned}$$

Let $y : X(\alpha, \beta) \rightarrow U^-$ (respectively $z : X(\alpha, \beta) \rightarrow U^+$) be the morphism defined by the property that $y^*(y_{ji}) = y_{ji}(\alpha, \beta)$ (respectively $z^*(z_{ij}) = z_{ij}(\alpha, \beta)$) for $1 \leq i, j \leq n$. Observe that just as in the case of \tilde{T} , multiplication by the rational function $t_r(\alpha, \beta)/t_0$ provides an isomorphism

$$\mathcal{O}_{X(\alpha, \beta)} \left(- \sum_{i=0}^{n-r} Z_i(\alpha, \beta) \right) \xrightarrow{\sim} \mathcal{O}_{X(\alpha, \beta)} \left(- \sum_{i=0}^{r-1} Y_i(\alpha, \beta) \right)$$

for $1 \leq r \leq n$, where $Y_i(\alpha, \beta)$ (respectively $Z_i(\alpha, \beta)$) denotes the restriction of Y_i (respectively Z_i) to the open set $X(\alpha, \beta)$. Thus, by lemma 4.3, the tuple

$$(\mathcal{O}(Y_i(\alpha, \beta)), \mathbf{1}, \mathcal{O}(Z_i(\alpha, \beta)), \mathbf{1} (i \in [0, n - 1]), t_r(\alpha, \beta)/t_0 (r \in [1, n]))$$

defines a morphism $t : X(\alpha, \beta) \rightarrow \tilde{T}$.

LEMMA 4.4. *The morphism $(y, t, z) : X(\alpha, \beta) \rightarrow U^- \times \tilde{T} \times U^+$ is an isomorphism.*

Proof. Let $\Omega(\alpha, \beta) \subset X(\alpha, \beta)$ be the preimage of Gl_n under the morphism $X(\alpha, \beta) \hookrightarrow \text{KGl}_n \rightarrow X^{(0)}$. By definition of KGl_n , we have for all $l \in \{0, \dots, n\}$:

$$\begin{aligned} \Omega(\alpha, \beta) &= X(\alpha, \beta, l) \setminus \bigcup_{i=0}^{n-1} (Y_i(\alpha, \beta, l) \cup Z_i(\alpha, \beta, l)) \\ &= \text{Spec } \mathbb{Z}[y_{ji}(\alpha, \beta), z_{ij}(\alpha, \beta) \ (1 \leq i < j \leq n), \\ &\quad (t_i(\alpha, \beta)/t_0)^{\pm 1} \ (1 \leq i \leq n)] \ . \end{aligned}$$

Let $T := \text{Spec } \mathbb{Z}[(t_i/t_0)^{\pm 1}] \subset \tilde{T}$ be the Torus in \tilde{T} . We have an isomorphism $\Omega(\alpha, \beta) \xrightarrow{\sim} U^- \times T \times U^+$ defined by $y_{ji} \mapsto y_{ji}(\alpha, \beta)$, $z_{ij} \mapsto z_{ij}(\alpha, \beta)$, $t_i/t_0 \mapsto t_i(\alpha, \beta)/t_0$, and a commutative quadrangle

$$\begin{array}{ccc} X(\alpha, \beta) & \xrightarrow{(y,t,z)} & U^- \times \tilde{T} \times U^+ \\ \uparrow & & \uparrow \\ \Omega(\alpha, \beta) & \xrightarrow{\sim} & U^- \times T \times U^+ \end{array} \ ,$$

where the vertical arrows are the natural inclusions. Furthermore, the map (y, t, z) induces an isomorphism $X(\alpha, \beta, l) \xrightarrow{\sim} U^- \times \tilde{T}_l \times U^+$ for $0 \leq l \leq n$. Using the fact that $X(\alpha, \beta)$ is separated and that $\Omega(\alpha, \beta)$ dense in $X(\alpha, \beta)$, the lemma now follows easily. □

5. BF-MORPHISMS AND GENERALIZED ISOMORPHISMS

DEFINITION 5.1. Let S be a scheme, \mathcal{E} and \mathcal{F} two locally free \mathcal{O}_S -modules and r a nonnegative integer. A *bf-morphism of rank r from \mathcal{E} to \mathcal{F}* is a tuple

$$g = (\mathcal{M}, \mu, \mathcal{E} \rightarrow \mathcal{F}, \mathcal{M} \otimes \mathcal{E} \leftarrow \mathcal{F}, r) \ ,$$

where \mathcal{M} is an invertible \mathcal{O}_S -module and μ a global section of \mathcal{M} such that the following holds:

1. The composed morphisms $\mathcal{E} \rightarrow \mathcal{F} \rightarrow \mathcal{M} \otimes \mathcal{E}$ and $\mathcal{F} \rightarrow \mathcal{M} \otimes \mathcal{E} \rightarrow \mathcal{M} \otimes \mathcal{F}$ are both induced by the morphism $\mu : \mathcal{O}_S \rightarrow \mathcal{M}$.
2. For every point $x \in S$ with $\mu(x) = 0$, the complex

$$\mathcal{E}[x] \rightarrow \mathcal{F}[x] \rightarrow (\mathcal{M} \otimes \mathcal{E})[x] \rightarrow (\mathcal{M} \otimes \mathcal{F})[x]$$

is exact and the rank of the morphism $\mathcal{E}[x] \rightarrow \mathcal{F}[x]$ equals r .

The letters “bf” stand for “back and forth”. As a matter of notation, we will sometimes write g^\sharp for the morphism $\mathcal{E} \rightarrow \mathcal{F}$ and g^\flat for the morphism $\mathcal{F} \rightarrow \mathcal{M} \otimes \mathcal{E}$ occurring in the bf-morphism g . Note that in case μ is nowhere vanishing, the number $\text{rk } g := r$ cannot be deduced from the other ingredients

of g . Sometimes we will use the following more suggestive notation for the bf-morphism g :

$$g = \left(\begin{array}{c} \begin{array}{ccc} & \circlearrowleft & \\ & \mathcal{E} & \mathcal{F} \\ & \mathcal{M}, \mu & \end{array} \\ \mathcal{E} \xrightarrow{r} \mathcal{F} \end{array} \right).$$

In situations where it is clear, what (\mathcal{M}, μ) and r are, we will sometimes omit these data from our notation:

$$g = \left(\begin{array}{c} \begin{array}{ccc} & \circlearrowleft & \\ & \mathcal{E} & \mathcal{F} \\ & \longrightarrow & \end{array} \\ \mathcal{E} \longrightarrow \mathcal{F} \end{array} \right).$$

DEFINITION 5.2. Let S be a scheme, \mathcal{E} and \mathcal{F} two locally free \mathcal{O}_S -modules of rank n . A *generalized isomorphism from \mathcal{E} to \mathcal{F}* is a tuple

$$\Phi = (\mathcal{L}_i, \lambda_i, \mathcal{M}_i, \mu_i, \mathcal{E}_i \rightarrow \mathcal{M}_i \otimes \mathcal{E}_{i+1}, \mathcal{E}_i \leftarrow \mathcal{E}_{i+1}, \mathcal{F}_{i+1} \rightarrow \mathcal{F}_i, \mathcal{L}_i \otimes \mathcal{F}_{i+1} \leftarrow \mathcal{F}_i \quad (0 \leq i \leq n-1), \mathcal{E}_n \xrightarrow{\sim} \mathcal{F}_n),$$

where $\mathcal{E} = \mathcal{E}_0, \mathcal{E}_1, \dots, \mathcal{E}_n, \mathcal{F}_n, \dots, \mathcal{F}_1, \mathcal{F}_0 = \mathcal{F}$, are locally free \mathcal{O}_S -modules of rank n and the tuples

$$\begin{aligned} & (\mathcal{M}_i, \mu_i, \mathcal{E}_{i+1} \rightarrow \mathcal{E}_i, \mathcal{M}_i \otimes \mathcal{E}_{i+1} \leftarrow \mathcal{E}_i, \quad i) \\ \text{and} \quad & (\mathcal{L}_i, \lambda_i, \mathcal{F}_{i+1} \rightarrow \mathcal{F}_i, \mathcal{L}_i \otimes \mathcal{F}_{i+1} \leftarrow \mathcal{F}_i, \quad i) \end{aligned}$$

are bf-morphisms of rank i for $0 \leq i \leq n-1$, such that for each $x \in S$ the following holds:

1. If $\mu_i(x) = 0$ and (f, g) is one of the following two pairs of morphisms:

$$\begin{aligned} \mathcal{E}[x] &\xrightarrow{f} ((\otimes_{j=0}^{i-1} \mathcal{M}_j) \otimes \mathcal{E}_i)[x] \xrightarrow{g} ((\otimes_{j=0}^i \mathcal{M}_j) \otimes \mathcal{E}_{i+1})[x], \\ \mathcal{E}_i[x] &\xleftarrow{g} \mathcal{E}_{i+1}[x] \xleftarrow{f} \mathcal{E}_n[x], \end{aligned}$$

then $\text{im}(g \circ f) = \text{im}(g)$. Likewise, if $\lambda_i(x) = 0$ and (f, g) is one of the following two pairs of morphisms:

$$\begin{aligned} \mathcal{F}_n[x] &\xrightarrow{f} \mathcal{F}_{i+1}[x] \xrightarrow{g} \mathcal{F}_i[x], \\ ((\otimes_{j=0}^i \mathcal{L}_j) \otimes \mathcal{F}_{i+1})[x] &\xleftarrow{g} ((\otimes_{j=0}^{i-1} \mathcal{L}_j) \otimes \mathcal{F}_i)[x] \xleftarrow{f} \mathcal{F}[x], \end{aligned}$$

then $\text{im}(g \circ f) = \text{im}(g)$.

2. In the diagram:

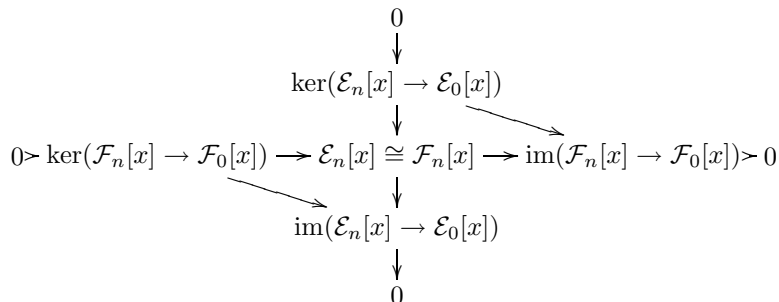

the oblique arrows are injections.

DEFINITION 5.3. A *quasi-equivalence* between two generalized isomorphisms

$$\begin{aligned} \Phi &= (\mathcal{L}_i, \lambda_i, \mathcal{M}_i, \mu_i, \mathcal{E}_i \rightarrow \mathcal{M}_i \otimes \mathcal{E}_{i+1}, \mathcal{E}_i \leftarrow \mathcal{E}_{i+1}, \\ &\quad \mathcal{F}_{i+1} \rightarrow \mathcal{F}_i, \mathcal{L}_i \otimes \mathcal{F}_{i+1} \leftarrow \mathcal{F}_i \quad (0 \leq i \leq n-1), \mathcal{E}_n \xrightarrow{\sim} \mathcal{F}_n), \\ \Phi' &= (\mathcal{L}'_i, \lambda'_i, \mathcal{M}'_i, \mu'_i, \mathcal{E}'_i \rightarrow \mathcal{M}'_i \otimes \mathcal{E}'_{i+1}, \mathcal{E}'_i \leftarrow \mathcal{E}'_{i+1}, \\ &\quad \mathcal{F}'_{i+1} \rightarrow \mathcal{F}'_i, \mathcal{L}'_i \otimes \mathcal{F}'_{i+1} \leftarrow \mathcal{F}'_i \quad (0 \leq i \leq n-1), \mathcal{E}'_n \xrightarrow{\sim} \mathcal{F}'_n) \end{aligned}$$

from \mathcal{E} to \mathcal{F} consists in isomorphisms $\mathcal{L}_i \xrightarrow{\sim} \mathcal{L}'_i$ and $\mathcal{M}_i \xrightarrow{\sim} \mathcal{M}'_i$ for $0 \leq i \leq n-1$, and isomorphisms $\mathcal{E}_i \xrightarrow{\sim} \mathcal{E}'_i$ and $\mathcal{F}_i \xrightarrow{\sim} \mathcal{F}'_i$ for $0 \leq i \leq n$, such that all the obvious diagrams are commutative. A quasi-equivalence between Φ and Φ' is called an *equivalence*, if the isomorphisms $\mathcal{E}_0 \xrightarrow{\sim} \mathcal{E}'_0$ and $\mathcal{F}_0 \xrightarrow{\sim} \mathcal{F}'_0$ are in fact the identity on \mathcal{E} and \mathcal{F} respectively.

After these general definitions, we now return to our scheme KGl_n . The notations are as in the previous section.

From the matrix-decomposition on page 560 (for $k = n$) we see that the matrix $[x_{ij}/x_{00}]_{1 \leq i, j \leq n}$ has entries in the subspace $\Gamma(\text{KGl}_n, \mathcal{O}(\sum_{i=0}^{n-1} Z_i))$ of the function field $\mathbb{Q}(\text{KGl}_n)$ of KGl_n . Therefore it defines a morphism

$$\mathbf{x} : E_0 \longrightarrow \mathcal{O}\left(\sum_{i=0}^{n-1} Z_i\right) \cdot F_0 \quad ,$$

where $E_0 = F_0 = \oplus^n \mathcal{O}_{\text{KGl}_n}$.

Let $E_n \subset E_0$ be the preimage under \mathbf{x} of $F_0 \subset \mathcal{O}(\sum_{i=0}^{n-1} Z_i) \cdot F_0$ and let $F_n \subset F_0$ be the image under \mathbf{x} of E_n . Thus \mathbf{x} induces a morphism

$$E_n \longrightarrow F_n \quad ,$$

which we again denote by \mathbf{x} . For $1 \leq i \leq n-1$ we define $\mathcal{O}_{\text{KGl}_n}$ -submodules E_i and F_i of $\oplus^n \mathcal{K}_{\text{KGl}_n}$ as follows:

$$\begin{aligned} E_i &:= E_n + \mathcal{O}\left(-\sum_{j=0}^{i-1} Z_j\right) \cdot E_0 \\ F_i &:= F_n + \mathcal{O}\left(-\sum_{j=0}^{i-1} Y_j\right) \cdot F_0 \end{aligned}$$

(the plus-sign means generation in $\oplus^n \mathcal{K}_{\text{KGl}_n}$). Observe that for $0 \leq i \leq n-1$ we have the following natural injections:

$$\begin{aligned} E_i &\hookrightarrow \mathcal{O}(Z_i) \cdot E_{i+1} \quad , \quad E_i \hookrightarrow E_{i+1} \\ F_{i+1} &\hookrightarrow F_i \quad , \quad \mathcal{O}(Y_i) \cdot F_{i+1} \hookrightarrow F_i \end{aligned}$$

PROPOSITION 5.4. *The tuple*

$$\begin{aligned} \Phi_{univ} &:= (\mathcal{O}(Y_i), \mathbf{1}_{\mathcal{O}(Y_i)}, \mathcal{O}(Z_i), \mathbf{1}_{\mathcal{O}(Z_i)}, E_i \hookrightarrow \mathcal{O}(Z_i) \cdot E_{i+1}, E_i \hookrightarrow E_{i+1}, \\ &\quad F_{i+1} \hookrightarrow F_i, \mathcal{O}(Y_i) \cdot F_{i+1} \hookrightarrow F_i \quad (0 \leq i \leq n-1), \mathbf{x} : E_n \rightarrow F_n) \end{aligned}$$

is a generalized isomorphism from $\oplus^n \mathcal{O}_{KGl_n}$ to itself.

Proof. It suffices to show that for each $(\alpha, \beta) \in S_n \times S_n$ the restriction of Φ_{univ} to the open set $X(\alpha, \beta)$ is a generalized isomorphism from $\oplus^n \mathcal{O}_{X(\alpha, \beta)}$ to itself. Let $\mathbf{z}(\alpha, \beta)$ ($\mathbf{y}(\alpha, \beta)$) be the upper (lower) triangular $n \times n$ matrix with 1 on the diagonal and entries $z_{ij}(\alpha, \beta)$ ($y_{ji}(\alpha, \beta)$) over (under) the diagonal ($1 \leq i < j \leq n$). For $0 \leq i \leq n$ we define

$$E_i(\alpha, \beta) := \mathbf{z}(\alpha, \beta) \cdot n_\beta^{-1} \cdot E_i|_{X(\alpha, \beta)} \quad ,$$

$$F_i(\alpha, \beta) := \mathbf{y}(\alpha, \beta)^{-1} \cdot n_\alpha^{-1} \cdot F_i|_{X(\alpha, \beta)} \quad .$$

Here we interpret the matrices $\mathbf{z}(\alpha, \beta) \cdot n_\beta^{-1}$ and $\mathbf{y}(\alpha, \beta)^{-1} \cdot n_\alpha^{-1}$ as automorphisms of $\oplus^n \mathcal{K}_{X(\alpha, \beta)}$. Accordingly we view the sheaves $E_i(\alpha, \beta)$ and $F_i(\alpha, \beta)$ as subsheaves of $\oplus^n \mathcal{K}_{X(\alpha, \beta)}$. We have to show that the tuple

$$\Phi(\alpha, \beta) := (\mathcal{O}(Y_i(\alpha, \beta)), \mathbf{1}_{\mathcal{O}(Y_i(\alpha, \beta))}, \mathcal{O}(Z_i(\alpha, \beta)), \mathbf{1}_{\mathcal{O}(Z_i(\alpha, \beta))}) \quad ,$$

$$E_i(\alpha, \beta) \hookrightarrow \mathcal{O}(Z_i(\alpha, \beta)) \cdot E_{i+1}(\alpha, \beta) \quad , \quad E_i(\alpha, \beta) \hookleftarrow E_{i+1}(\alpha, \beta) \quad ,$$

$$F_{i+1}(\alpha, \beta) \hookrightarrow F_i(\alpha, \beta) \quad , \quad \mathcal{O}(Y_i(\alpha, \beta)) \cdot F_{i+1}(\alpha, \beta) \hookleftarrow F_i(\alpha, \beta) \quad ,$$

$$(0 \leq i \leq n-1) \quad ,$$

$$\mathbf{y}(\alpha, \beta)^{-1} n_\alpha^{-1} \mathbf{x} n_\beta \mathbf{z}(\alpha, \beta)^{-1} : E_n(\alpha, \beta) \xrightarrow{\sim} F_n(\alpha, \beta)$$

is a generalized isomorphism from $\oplus^n \mathcal{O}_{X(\alpha, \beta)}$ to itself.

We have for $0 \leq i \leq n$ the following equality of subsheaves of $\oplus^n \mathcal{K}_{X(\alpha, \beta)}$:

$$E_i(\alpha, \beta) = \bigoplus_{j=1}^{n-i} \mathcal{O} \left(- \sum_{\nu=0}^{i-1} Z_\nu(\alpha, \beta) \right) \oplus \bigoplus_{j=n-i+1}^n \mathcal{O} \left(- \sum_{\nu=0}^{n-j} Z_\nu(\alpha, \beta) \right) \quad ,$$

$$F_i(\alpha, \beta) = \bigoplus_{j=1}^i \mathcal{O} \left(- \sum_{\nu=0}^{j-1} Y_\nu(\alpha, \beta) \right) \oplus \bigoplus_{j=i+1}^n \mathcal{O} \left(- \sum_{\nu=0}^{i-1} Y_\nu(\alpha, \beta) \right) \quad .$$

This is easily checked by restricting both sides of the equations to the open subsets $X(\alpha, \beta, l)$, ($0 \leq l \leq n$) of $X(\alpha, \beta)$ and using 4.1. Observe that the morphisms

$$E_i(\alpha, \beta) \hookrightarrow \mathcal{O}(Z_i(\alpha, \beta)) \cdot E_{i+1}(\alpha, \beta) \quad , \quad E_i(\alpha, \beta) \hookleftarrow E_{i+1}(\alpha, \beta)$$

are described by the matrices

$$\begin{bmatrix} \mathbb{I}_{n-i} & 0 \\ 0 & \mu_i \mathbb{I}_i \end{bmatrix} \quad \text{and} \quad \begin{bmatrix} \mu_i \mathbb{I}_{n-i} & 0 \\ 0 & \mathbb{I}_i \end{bmatrix} \quad ,$$

and the morphisms

$$F_{i+1}(\alpha, \beta) \hookrightarrow F_i(\alpha, \beta) \quad , \quad \mathcal{O}(Y_i(\alpha, \beta)) \cdot F_{i+1}(\alpha, \beta) \hookleftarrow F_i(\alpha, \beta)$$

by the matrices

$$\begin{bmatrix} \mathbb{I}_i & 0 \\ 0 & \lambda_i \mathbb{I}_{n-i} \end{bmatrix} \quad \text{and} \quad \begin{bmatrix} \lambda_i \mathbb{I}_i & 0 \\ 0 & \mathbb{I}_{n-i} \end{bmatrix}$$

respectively, where we have abbreviated $\mathbf{1}_{\mathcal{O}(Y_i(\alpha, \beta))}$ by λ_i , and $\mathbf{1}_{\mathcal{O}(Z_i(\alpha, \beta))}$ by μ_i . Furthermore the matrix-decomposition on page 560 (for $k = n$)

shows that $\mathbf{y}(\alpha, \beta)^{-1} n_{\alpha}^{-1} \mathbf{x} n_{\beta} \mathbf{z}(\alpha, \beta)^{-1}$ is the diagonal matrix with entries $(t_1(\alpha, \beta)/t_0, \dots, t_n(\alpha, \beta)/t_0)$. With this information at hand, it is easy to see that $\Phi(\alpha, \beta)$ is indeed a generalized isomorphism from $\oplus^n \mathcal{O}_{X(\alpha, \beta)}$ to itself. \square

THEOREM 5.5. *Let S be a scheme and Φ a generalized isomorphism from $\oplus^n \mathcal{O}_S$ to itself. Then there is a unique morphism $f : S \rightarrow KGl_n$ such that $f^* \Phi_{univ}$ is equivalent to Φ . In other words, the scheme KGl_n together with Φ_{univ} represents the functor, which to each scheme S associates the set of equivalence classes of generalized isomorphisms from $\oplus^n \mathcal{O}_S$ to itself.*

The proof of the theorem will be given in section 7.

COROLLARY 5.6. *There is a (left) action of $Gl_n \times Gl_n$ on KGl_n , which extends the action $((\varphi, \psi), \Phi) \mapsto \psi \Phi \varphi^{-1}$ of $Gl_n \times Gl_n$ on Gl_n . The divisors Z_i and Y_i are invariant under this action.*

Proof. The morphism $(Gl_n \times Gl_n) \times KGl_n \rightarrow KGl_n$ defining the action is given on S -valued points by

$$((\varphi, \psi), \Phi) \mapsto \Phi' \quad ,$$

where Φ is a generalized isomorphism as in definition 5.2 from $\mathcal{E}_0 = \oplus^n \mathcal{O}_S$ to $\mathcal{F}_0 = \oplus^n \mathcal{O}_S$ and Φ' is the generalized isomorphism where for $2 \leq i \leq n$ the bf-morphisms from \mathcal{E}_i to \mathcal{E}_{i-1} , the ones from \mathcal{F}_i to \mathcal{F}_{i-1} and the isomorphism $\mathcal{E}_n \xrightarrow{\sim} \mathcal{F}_n$ are the same as in the tuple Φ , and where the bf-morphisms

$$(\mathcal{M}_0, \mu_0, \mathcal{E}_1 \rightarrow \mathcal{E}_0, \mathcal{M}_0 \otimes \mathcal{E}_0 \leftarrow \mathcal{E}_1, 0)$$

and $(\mathcal{L}_0, \lambda_0, \mathcal{F}_1 \rightarrow \mathcal{F}_0, \mathcal{L}_0 \otimes \mathcal{F}_0 \leftarrow \mathcal{F}_1, 0)$

in the tuple Φ are replaced by the bf-morphisms

$$(\mathcal{M}_0, \mu_0, \mathcal{E}_1 \rightarrow \mathcal{E}_0 \xrightarrow{\varphi} \mathcal{E}_0, \mathcal{M}_0 \otimes \mathcal{E}_1 \leftarrow \mathcal{E}_0 \xleftarrow{\varphi^{-1}} \mathcal{E}_0, 0)$$

and $(\mathcal{L}_0, \lambda_0, \mathcal{F}_1 \rightarrow \mathcal{F}_0 \xrightarrow{\psi} \mathcal{F}_0, \mathcal{L}_0 \otimes \mathcal{F}_1 \leftarrow \mathcal{F}_0 \xleftarrow{\psi^{-1}} \mathcal{F}_0, 0)$

respectively. The invariance of the divisors Z_i and Y_i is clear, since they are defined by the vanishing of μ_i and λ_i respectively. \square

6. EXTERIOR POWERS

LEMMA 6.1. *Let S be a scheme and \mathcal{E}, \mathcal{F} two locally free \mathcal{O}_S -modules of rank n . Let*

$$g = (\mathcal{M}, \mu, \mathcal{E} \rightarrow \mathcal{F}, \mathcal{M} \otimes \mathcal{E} \leftarrow \mathcal{F}, \quad r)$$

be a bf-morphism of rank r from \mathcal{E} to \mathcal{F} . Then each point $x \in S$ has an open neighbourhood U such that over U there exist local frames (e_1, \dots, e_n) and (f_1, \dots, f_n) for \mathcal{E} and \mathcal{F} respectively with the property that the matrices for the morphisms

$$\mathcal{E} \longrightarrow \mathcal{F} \quad \text{and} \quad \mathcal{M} \otimes \mathcal{E} \longleftarrow \mathcal{F}$$

with respect to these frames are

$$\begin{bmatrix} \mathbb{I}_r & 0 \\ 0 & \mu/m \mathbb{I}_{n-r} \end{bmatrix} \quad \text{and} \quad \begin{bmatrix} \mu \mathbb{I}_r & 0 \\ 0 & m \mathbb{I}_{n-r} \end{bmatrix}$$

respectively, where m is a nowhere vanishing section of \mathcal{M} over U .

Proof. Restricting to a neighbourhood of x , we may assume that the sheaves $\mathcal{M}, \mathcal{E}, \mathcal{F}$ are free. Let $(\tilde{e}_1, \dots, \tilde{e}_n)$ and $(\tilde{f}_1, \dots, \tilde{f}_n)$ be global frames for \mathcal{E} and \mathcal{F} respectively. After permutation of their elements, and restricting to a possibly smaller neighbourhood of x , we may further assume that the morphisms

$$\begin{aligned} \langle \tilde{e}_1, \dots, \tilde{e}_r \rangle &\longrightarrow \mathcal{F} / \langle \tilde{f}_{r+1}, \dots, \tilde{f}_n \rangle \\ \langle \tilde{f}_{r+1}, \dots, \tilde{f}_n \rangle &\longrightarrow \mathcal{M} \otimes \mathcal{E} / \langle \tilde{e}_1, \dots, \tilde{e}_r \rangle \end{aligned}$$

induced by g^\sharp and g^\flat respectively, are isomorphisms. Let

$$\begin{aligned} \tilde{\mathcal{E}} &:= \langle \tilde{e}_1, \dots, \tilde{e}_r \rangle \quad , \quad \tilde{\mathcal{E}}' := \ker(\mathcal{E} \rightarrow \mathcal{M} \otimes \mathcal{F} / \langle \tilde{f}_{r+1}, \dots, \tilde{f}_n \rangle) \\ \tilde{\mathcal{F}} &:= \ker(\mathcal{F} \rightarrow \mathcal{E} / \langle \tilde{e}_1, \dots, \tilde{e}_r \rangle) \quad , \quad \tilde{\mathcal{F}}' := \langle \tilde{f}_{r+1}, \dots, \tilde{f}_n \rangle . \end{aligned}$$

Then we have direct-sum decompositions $\mathcal{E} = \tilde{\mathcal{E}} \oplus \tilde{\mathcal{E}}'$, $\mathcal{F} = \tilde{\mathcal{F}} \oplus \tilde{\mathcal{F}}'$, which are respected by g^\sharp and g^\flat . Let m be a nowhere vanishing section of \mathcal{M} . The frames $(e_1, \dots, e_n), (f_1, \dots, f_n)$ of \mathcal{E}, \mathcal{F} , defined by setting $e_i := \tilde{e}_i, f_i := g^\sharp(\tilde{e}_i)$ for $1 \leq i \leq r$ and $e_i := (1/m)g^\flat(\tilde{f}_i), f_i := \tilde{f}_i$ for $r+1 \leq i \leq n$, have the desired property. □

PROPOSITION 6.2. *Let S be a scheme and \mathcal{E}, \mathcal{F} two locally free \mathcal{O}_S -modules of rank n . Let*

$$g = (\mathcal{M}, \mu, \mathcal{E} \rightarrow \mathcal{F}, \mathcal{M} \otimes \mathcal{E} \leftarrow \mathcal{F}, \quad i)$$

be a bf-morphism of rank i from \mathcal{E} to \mathcal{F} and let $1 \leq r \leq n$.

1. *There exists a unique morphism*

$$\wedge^r g : \wedge^r \mathcal{E} \longrightarrow (\mathcal{M}^\vee)^{\otimes \max(0, r-i)} \otimes \wedge^r \mathcal{F}$$

with the following property: If (e_1, \dots, e_n) and (f_1, \dots, f_n) are local frames for \mathcal{E} and \mathcal{F} respectively over an open set $U \subseteq S$, such that the matrices for the morphisms

$$\mathcal{E} \longrightarrow \mathcal{F} \quad \text{and} \quad \mathcal{M} \otimes \mathcal{E} \longleftarrow \mathcal{F}$$

with respect to these frames are

$$\begin{bmatrix} \mathbb{I}_i & 0 \\ 0 & \mu/m\mathbb{I}_{n-i} \end{bmatrix} \quad \text{and} \quad \begin{bmatrix} \mu\mathbb{I}_i & 0 \\ 0 & m\mathbb{I}_{n-i} \end{bmatrix}$$

respectively (m being a nowhere vanishing section of \mathcal{M} over U), then $(\wedge^r g)|_U$ takes the form

$$e_I \wedge e_J \mapsto m^{p-r} \otimes \mu^{\min(i,r)-p} \otimes f_I \wedge f_J \quad ,$$

where $I \subseteq \{1, \dots, i\}, J \subseteq \{i+1, \dots, n\}$ with $\sharp I = p, \sharp J = r-p$ and where $e_I = e_{i_1} \wedge \dots \wedge e_{i_p}$, if $I = \{i_1, \dots, i_p\}$ and $i_1 < \dots < i_p$. The e_J, f_I, f_J are defined analogously.

2. Similarly, there exists a unique morphism

$$\wedge^{-r} g : \wedge^r \mathcal{F} \longrightarrow \mathcal{M}^{\otimes \min(r, n-i)} \otimes \wedge^r \mathcal{E}$$

with the following property: If (e_1, \dots, e_n) and (f_1, \dots, f_n) are local frames for \mathcal{E} and \mathcal{F} respectively over an open set $U \subseteq S$, such that the matrices for the morphisms

$$\mathcal{F} \longrightarrow \mathcal{M} \otimes \mathcal{E} \quad \text{and} \quad \mathcal{E} \longleftarrow \mathcal{F}$$

with respect to these frames are

$$\begin{bmatrix} m\mathbb{I}_{n-i} & 0 \\ 0 & \mu\mathbb{I}_i \end{bmatrix} \quad \text{and} \quad \begin{bmatrix} \mu/m\mathbb{I}_{n-i} & 0 \\ 0 & \mathbb{I}_i \end{bmatrix}$$

respectively (m being a nowhere vanishing section of \mathcal{M} over U), then $(\wedge^{-r} g)|_U$ takes the form

$$f_I \wedge f_J \mapsto m^p \otimes \mu^{\min(r, n-i)-p} \otimes e_I \wedge e_J \quad ,$$

where $I \subseteq \{1, \dots, n-i\}$, $J \subseteq \{n-i+1, \dots, n\}$ with $\#I = p$, $\#J = r-p$.

Proof. 1. An easy calculation shows that the morphism given by the prescription

$$e_I \wedge e_J \mapsto m^{p-r} \otimes \mu^{\min(i, r)-p} \otimes f_I \wedge f_J \quad ,$$

does not depend on the chosen local frames (e_1, \dots, e_n) , (f_1, \dots, f_n) . Therefore using 6.1, we may define $\wedge^r g$ by this local prescription.

2. This can be proven along the same lines as 1. Alternatively, it follows by applying 1. to the bf-morphism $(\mathcal{M}, \mu, \mathcal{E}' \rightarrow \mathcal{F}', \mathcal{M} \otimes \mathcal{E}' \leftarrow \mathcal{F}', n-r)$ obtained from g by setting $\mathcal{E}' := \mathcal{F}$ and $\mathcal{F}' := \mathcal{M} \otimes \mathcal{E}$. □

In the situation of the above proposition 6.2, assume that $\mathcal{E} = \mathcal{E}_1 \oplus \mathcal{E}_2$ and $\mathcal{F} = \mathcal{F}_1 \oplus \mathcal{F}_2$, where $\text{rk } \mathcal{E}_i = \text{rk } \mathcal{F}_i =: n_i$ for $i = 1, 2$. Assume furthermore that the morphisms $\mathcal{E} \rightarrow \mathcal{F}$ and $\mathcal{F} \rightarrow \mathcal{M} \otimes \mathcal{E}$ both respect these direct-sum decompositions and that there are $i_1, i_2 \geq 0$ with $i_1 + i_2 = i$, such that the tuples

$$\begin{aligned} g_1 &:= (\mathcal{M}, \mu, \mathcal{E}_1 \rightarrow \mathcal{F}_1, \mathcal{M} \otimes \mathcal{E}_1 \leftarrow \mathcal{F}_1, i_1) \\ \text{and } g_2 &:= (\mathcal{M}, \mu, \mathcal{E}_2 \rightarrow \mathcal{F}_2, \mathcal{M} \otimes \mathcal{E}_2 \leftarrow \mathcal{F}_2, i_2) \quad , \end{aligned}$$

induced by g , are also bf-morphisms. We write $g = g_1 \oplus g_2$. The following lemma says that exterior powers of bf-morphisms are compatible with direct sums whenever this makes sense.

LEMMA 6.3. *Let $1 \leq r \leq n$ and $r = r_1 + r_2$ for some $r_1, r_2 \geq 0$.*

1. *If $\max(0, r-i) = \max(0, r_1-i_1) + \max(0, r_2-i_2)$, then we have for every $\epsilon_1 \in \Gamma(S, \wedge^{r_1} \mathcal{E}_1)$, $\epsilon_2 \in \Gamma(S, \wedge^{r_2} \mathcal{E}_2)$ the following equality:*

$$(\wedge^r g)(\epsilon_1 \wedge \epsilon_2) = (\wedge^{r_1} g_1)(\epsilon_1) \wedge (\wedge^{r_2} g_2)(\epsilon_2) \quad .$$

2. *If $\min(i, r) = \min(i_1, r_1) + \min(i_2, r_2)$, then we have for every $\omega_1 \in \Gamma(S, \wedge^{r_1} \mathcal{F}_1)$, $\omega_2 \in \Gamma(S, \wedge^{r_2} \mathcal{F}_2)$ the following equality:*

$$(\wedge^{-r} g)(\omega_1 \wedge \omega_2) = (\wedge^{-r_1} g_1)(\omega_1) \wedge (\wedge^{-r_2} g_2)(\omega_2) \quad .$$

Proof. This follows immediately from the local description of $\wedge^r g$ and $\wedge^{-r} g$ respectively. \square

DEFINITION 6.4. Let S be a scheme, \mathcal{E} and \mathcal{F} two locally free \mathcal{O}_S -modules of rank n and

$$\Phi = (\mathcal{L}_i, \lambda_i, \mathcal{M}_i, \mu_i, \mathcal{E}_i \rightarrow \mathcal{M}_i \otimes \mathcal{E}_{i+1}, \mathcal{E}_i \leftarrow \mathcal{E}_{i+1}, \mathcal{F}_{i+1} \rightarrow \mathcal{F}_i, \mathcal{L}_i \otimes \mathcal{F}_{i+1} \leftarrow \mathcal{F}_i \quad (0 \leq i \leq n-1), \mathcal{E}_n \xrightarrow{\sim} \mathcal{F}_n),$$

a generalized isomorphism from $\mathcal{E} = \mathcal{E}_0$ to $\mathcal{F} = \mathcal{F}_0$. For $1 \leq r \leq n$ we define the r -th exterior power

$$\wedge^r \Phi : \bigwedge^r \mathcal{E} \longrightarrow \bigotimes_{\nu=1}^r \left(\bigotimes_{i=0}^{\nu-1} \mathcal{L}_i^\vee \otimes \bigotimes_{i=0}^{n-\nu} \mathcal{M}_i \right) \otimes \bigwedge^r \mathcal{F}$$

of Φ as the composition

$$\wedge^r \Phi := (\wedge^{-r} g_0) \circ (\wedge^{-r} g_1) \circ \dots \circ (\wedge^{-r} g_{n-1}) \circ (\wedge^r h_n) \circ (\wedge^r h_{n-1}) \circ \dots \circ (\wedge^r h_0) \quad ,$$

where g_i and h_i are the bf-morphisms

$$\begin{aligned} & (\mathcal{M}_i, \mu_i, \mathcal{E}_{i+1} \rightarrow \mathcal{E}_i, \mathcal{M}_i \otimes \mathcal{E}_{i+1} \leftarrow \mathcal{E}_i, \quad i) \\ \text{and} \quad & (\mathcal{L}_i, \lambda_i, \mathcal{F}_{i+1} \rightarrow \mathcal{F}_i, \mathcal{L}_i \otimes \mathcal{F}_{i+1} \leftarrow \mathcal{F}_i, \quad i) \end{aligned}$$

respectively for $0 \leq i \leq n-1$, and where h_n is the isomorphism $\mathcal{E}_n \xrightarrow{\sim} \mathcal{F}_n$.

In the situation of the above definition consider especially the case, where $\mathcal{E} = \bigoplus^n \mathcal{O}_S$ and $\mathcal{F} = \bigoplus^n \mathcal{L}$ for some invertible \mathcal{O}_S -module \mathcal{L} . Then we have natural direct sum decompositions

$$\bigwedge^r \mathcal{E} = \bigoplus_B \mathcal{O}_S \quad \text{and} \quad \bigwedge^r \mathcal{F} = \bigoplus_A \mathcal{L}^r \quad ,$$

where A and B run through all subsets of cardinality r of $\{1, \dots, n\}$. For two such subsets A and B , we denote by π_A (respectively by ι_B) the projection $\wedge^r \mathcal{F} \rightarrow \mathcal{L}^r$ onto the A -th component (respectively the inclusion $\mathcal{O}_S \hookrightarrow \wedge^r \mathcal{E}$ of the B -th component). Now we define

$$\det_{A,B} \Phi := \pi_A \circ (\wedge^r \Phi) \circ \iota_B : \mathcal{O}_S \longrightarrow \bigotimes_{\nu=1}^r \left(\bigotimes_{i=0}^{\nu-1} \mathcal{L}_i^\vee \otimes \bigotimes_{i=0}^{n-\nu} \mathcal{M}_i \right) \otimes \mathcal{L}^r \quad .$$

LEMMA 6.5. Let $(\alpha, \beta) \in S_n \times S_n$ and let $X(\alpha, \beta)$ be the open set of KGl_n defined in section 4. Let Φ_{univ} be the generalized isomorphism defined in 5.4. Then the sections $\det_{\alpha[1,r], \beta[1,r]} \Phi_{univ}$ are nowhere vanishing on $X(\alpha, \beta)$ for $1 \leq r \leq n$.

Proof. From the proof of 5.4 it follows readily that the restriction of $\det_{\alpha[1,r], \beta[1,r]} \Phi_{univ}$ to $X(\alpha, \beta)$ is $\prod_{\nu=1}^r (t_\nu(\alpha, \beta)/t_0)$ as an element of

$$\Gamma \left(X(\alpha, \beta), \mathcal{O} \left(\sum_{\nu=1}^r \left(\sum_{i=0}^{n-\nu} Z_i - \sum_{i=0}^{\nu-1} Y_i \right) \right) \right) \subset \Gamma(X(\alpha, \beta), \mathcal{K}_{KGl_n}) \quad .$$

On the other hand, 4.1 tells us that $\prod_{\nu=1}^r (t_\nu(\alpha, \beta)/t_0)$ is a generator of $\mathcal{O}(\sum_{\nu=1}^r (\sum_{i=0}^{n-\nu} Z_i - \sum_{i=0}^{\nu-1} Y_i))$ over $X(\alpha, \beta)$. □

7. PROOF OF THEOREM 5.5

Let S be a scheme, \mathcal{L} an invertible \mathcal{O}_S -module. For $0 \leq i \leq n - 1$ let $(\mathcal{L}_i, \lambda_i)$, (\mathcal{M}_i, μ_i) be invertible \mathcal{O}_S -modules together with global sections, such that the zero sets of λ_i and μ_j do not intersect for $i + j < n$. Given these data, we associate to every tuple $(\varphi_1, \dots, \varphi_n)$ of isomorphisms

$$\varphi_r : \bigotimes_{i=0}^{n-r} \mathcal{M}_i^\vee \xrightarrow{\sim} \bigotimes_{i=0}^{r-1} \mathcal{L}_i^\vee \otimes \mathcal{L} \quad (1 \leq r \leq n)$$

the following generalized isomorphism from $\oplus^n \mathcal{O}_S$ to $\oplus^n \mathcal{L}$:

$$\begin{aligned} \Phi(\varphi_1, \dots, \varphi_n) := & (\mathcal{L}_i, \lambda_i, \mathcal{M}_i, \mu_i, \mathcal{E}_i \rightarrow \mathcal{M}_i \otimes \mathcal{E}_{i+1}, \mathcal{E}_i \leftarrow \mathcal{E}_{i+1}, \\ & \mathcal{F}_{i+1} \rightarrow \mathcal{F}_i, \mathcal{L}_i \otimes \mathcal{F}_{i+1} \leftarrow \mathcal{F}_i \ (0 \leq i \leq n - 1), \mathcal{E}_n \xrightarrow{\sim} \mathcal{F}_n) , \end{aligned}$$

where the locally free modules \mathcal{E}_i and \mathcal{F}_i are defined as

$$\begin{aligned} \mathcal{E}_i & := \bigoplus_{j=1}^{n-i} \left(\bigotimes_{\nu=0}^{i-1} \mathcal{M}_\nu^\vee \right) \oplus \bigoplus_{j=n-i+1}^n \left(\bigotimes_{\nu=0}^{n-j} \mathcal{M}_\nu^\vee \right) , \\ \mathcal{F}_i & := \left(\bigoplus_{j=1}^i \left(\bigotimes_{\nu=0}^{j-1} \mathcal{L}_\nu^\vee \right) \oplus \bigoplus_{j=i+1}^n \left(\bigotimes_{\nu=0}^{i-1} \mathcal{L}_\nu^\vee \right) \right) \otimes \mathcal{L} , \end{aligned}$$

the morphisms

$$\mathcal{E}_i \longrightarrow \mathcal{M}_i \otimes \mathcal{E}_{i+1} \quad \text{and} \quad \mathcal{E}_i \longleftarrow \mathcal{E}_{i+1}$$

are described by the matrices

$$\begin{bmatrix} \mathbb{I}_{n-i} & 0 \\ 0 & \mu_i \mathbb{I}_i \end{bmatrix} \quad \text{and} \quad \begin{bmatrix} \mu_i \mathbb{I}_{n-i} & 0 \\ 0 & \mathbb{I}_i \end{bmatrix} ,$$

the morphisms

$$\mathcal{F}_{i+1} \longrightarrow \mathcal{F}_i \quad \text{and} \quad \mathcal{L}_i \otimes \mathcal{F}_{i+1} \longleftarrow \mathcal{F}_i$$

by the matrices

$$\begin{bmatrix} \mathbb{I}_i & 0 \\ 0 & \lambda_i \mathbb{I}_{n-i} \end{bmatrix} \quad \text{and} \quad \begin{bmatrix} \lambda_i \mathbb{I}_i & 0 \\ 0 & \mathbb{I}_{n-i} \end{bmatrix}$$

respectively, and the isomorphism $\mathcal{E}_n \xrightarrow{\sim} \mathcal{F}_n$ is given by the diagonal matrix with entries $(\varphi_1, \dots, \varphi_n)$.

DEFINITION 7.1. Let S be a scheme, \mathcal{L} an invertible \mathcal{O}_S -module and

$$\begin{aligned} \Phi := & (\mathcal{L}_i, \lambda_i, \mathcal{M}_i, \mu_i, \mathcal{E}_i \rightarrow \mathcal{M}_i \otimes \mathcal{E}_{i+1}, \mathcal{E}_i \leftarrow \mathcal{E}_{i+1}, \\ & \mathcal{F}_{i+1} \rightarrow \mathcal{F}_i, \mathcal{L}_i \otimes \mathcal{F}_{i+1} \leftarrow \mathcal{F}_i \ (0 \leq i \leq n - 1), \mathcal{E}_n \xrightarrow{\sim} \mathcal{F}_n) \end{aligned}$$

an arbitrary generalized isomorphism from $\mathcal{E}_0 = \oplus^n \mathcal{O}_S$ to $\mathcal{F}_0 = \oplus^n \mathcal{L}$. A diagonalization of Φ with respect to a pair $(\alpha, \beta) \in S_n \times S_n$ of permutations is a tuple $(u_i, v_i (0 \leq i \leq n), (\varphi_1, \dots, \varphi_n))$ of isomorphisms

$$\begin{aligned}
 u_i & : \quad \mathcal{E}_i \xrightarrow{\sim} \bigoplus_{j=1}^{n-i} \left(\bigotimes_{\nu=0}^{i-1} \mathcal{M}_\nu^\vee \right) \oplus \bigoplus_{j=n-i+1}^n \left(\bigotimes_{\nu=0}^{n-j} \mathcal{M}_\nu^\vee \right) \quad (0 \leq i \leq n) \\
 v_i & : \quad \mathcal{F}_i \xrightarrow{\sim} \left(\bigoplus_{j=1}^i \left(\bigotimes_{\nu=0}^{j-1} \mathcal{L}_\nu^\vee \right) \oplus \bigoplus_{j=i+1}^n \left(\bigotimes_{\nu=0}^{i-1} \mathcal{L}_\nu^\vee \right) \right) \otimes \mathcal{L} \quad (0 \leq i \leq n) \\
 \varphi_r & : \quad \bigotimes_{i=0}^{n-r} \mathcal{M}_i^\vee \xrightarrow{\sim} \bigotimes_{i=0}^{r-1} \mathcal{L}_i^\vee \otimes \mathcal{L} \quad (1 \leq r \leq n)
 \end{aligned}$$

such that $(u_i, v_i (0 \leq i \leq n))$ establishes a quasi-equivalence between Φ and $\Phi(\varphi_1, \dots, \varphi_n)$ and such that

$$u_n \cdot n_\beta : \mathcal{E}_0 = \oplus^n \mathcal{O}_S \xrightarrow{\sim} \oplus^n \mathcal{O}_S \quad \text{and} \quad v_n \cdot n_\alpha : \mathcal{F}_0 = \oplus^n \mathcal{L} \xrightarrow{\sim} \oplus^n \mathcal{L}$$

are described by upper and lower triangular matrices respectively, with unit diagonal entries.

DEFINITION 7.2. As in the above definition let Φ be a generalized isomorphism from $\oplus^n \mathcal{O}_S$ to $\oplus^n \mathcal{L}$. A pair $(\alpha, \beta) \in S_n \times S_n$ of permutations is called *admissible*, if for all $1 \leq r \leq n$ the global sections $\det_{\alpha[1,r], \beta[1,r]} \Phi$ of

$$\bigotimes_{\nu=1}^r \left(\bigotimes_{i=0}^{n-\nu} \mathcal{M}_i \otimes \bigotimes_{i=0}^{\nu-1} \mathcal{L}_i^\vee \right) \otimes \mathcal{L}^r$$

are nowhere vanishing on S .

PROPOSITION 7.3. Let S be a scheme, \mathcal{L} an invertible \mathcal{O}_S -module and Φ a generalized isomorphism from $\oplus^n \mathcal{O}_S$ to $\oplus^n \mathcal{L}$. Then:

1. For $(\alpha, \beta) \in S_n \times S_n$ the following are equivalent:
 - (a) there exists a diagonalization of Φ with respect to (α, β)
 - (b) (α, β) is admissible for Φ
2. Every point of S has an open neighbourhood U , such that there is a diagonalization of $\Phi|_U$ with respect to some pair $(\alpha, \beta) \in S_n \times S_n$.
3. For a given pair $(\alpha, \beta) \in S_n \times S_n$ there is at most one diagonalization of Φ with respect to (α, β) .

Proof. Let

$$\begin{aligned}
 \Phi & := (\mathcal{L}_i, \lambda_i, \mathcal{M}_i, \mu_i, \mathcal{E}_i \rightarrow \mathcal{M}_i \otimes \mathcal{E}_{i+1}, \mathcal{E}_i \leftarrow \mathcal{E}_{i+1}, \\
 & \quad \mathcal{F}_{i+1} \rightarrow \mathcal{F}_i, \mathcal{L}_i \otimes \mathcal{F}_{i+1} \leftarrow \mathcal{F}_i \quad (0 \leq i \leq n-1), \mathcal{E}_n \xrightarrow{\sim} \mathcal{F}_n),
 \end{aligned}$$

be a generalized isomorphism from $\mathcal{E}_0 = \oplus^n \mathcal{O}_S$ to $\mathcal{F}_0 = \oplus^n \mathcal{L}$. For $0 \leq i \leq n-1$ denote bf-morphisms as follows:

$$\begin{aligned}
 g_i & := (\mathcal{M}_i, \mu_i, \mathcal{E}_{i+1} \rightarrow \mathcal{E}_i, \mathcal{M}_i \otimes \mathcal{E}_{i+1} \leftarrow \mathcal{E}_i, i) \quad , \\
 h_i & := (\mathcal{L}_i, \lambda_i, \mathcal{F}_{i+1} \rightarrow \mathcal{F}_i, \mathcal{L}_i \otimes \mathcal{F}_{i+1} \leftarrow \mathcal{F}_i, i) \quad ,
 \end{aligned}$$

and let h_n the isomorphism $\mathcal{E}_n \xrightarrow{\sim} \mathcal{F}_n$.

1. We may assume that $\alpha = \beta = \text{id}$. We show by induction on n that admissibility of (id, id) for Φ implies the diagonalizability of Φ with respect to (id, id) . The case $n = 1$ is trivial, so assume $n \geq 2$. By assumption, the morphism

$$\det_{\{1\}, \{1\}} \Phi : \mathcal{O}_S \longrightarrow \mathcal{L}_0^\vee \otimes \bigotimes_{i=0}^{n-1} \mathcal{M}_i \otimes \mathcal{L}$$

is an isomorphism. Let

$$\begin{aligned} \tilde{\mathcal{E}}'_i &:= \ker(\pi_1 \circ (\wedge^1 h_0) \circ \dots \circ (\wedge^{-1} g_i) : \mathcal{E}_i \longrightarrow \mathcal{L}_0^\vee \otimes \bigotimes_{j=i}^{n-1} \mathcal{M}_j \otimes \mathcal{L}) && (i \in [0, n]) \\ \tilde{\mathcal{F}}'_i &:= \ker(\pi_1 \circ (\wedge^1 h_0) \circ \dots \circ (\wedge^1 h_{i-1}) : \mathcal{F}_i \longrightarrow \mathcal{L}_0^\vee \otimes \mathcal{L}) && (i \in [1, n]) \\ \tilde{\mathcal{F}}'_0 &:= \ker(\pi_1 : \bigoplus^n \mathcal{L} \longrightarrow \mathcal{L}) = \bigoplus^{n-1} \mathcal{L} \end{aligned}$$

and

$$\begin{aligned} \tilde{\mathcal{E}}_i &:= \text{im}((\wedge^{-1} g_{i-1}) \circ \dots \circ (\wedge^{-1} g_0) \circ \iota_1 : \bigotimes_{j=0}^{i-1} \mathcal{M}_j \longrightarrow \mathcal{E}_i) && (i \in [0, n]) \\ \tilde{\mathcal{F}}_i &:= \text{im}((\wedge^1 h_i) \circ \dots \circ (\wedge^{-1} g_0) \circ \iota_1 : \bigotimes_{j=0}^{n-1} \mathcal{M}_j \longrightarrow \mathcal{F}_i) && (i \in [1, n]) \\ \tilde{\mathcal{F}}_0 &:= \text{im}((\wedge^1 h_0) \circ \dots \circ (\wedge^{-1} g_0) \circ \iota_1 : \mathcal{L}_0^\vee \otimes \bigotimes_{j=0}^{n-1} \mathcal{M}_j \longrightarrow \mathcal{F}_0) \end{aligned}$$

Then we have natural direct sum decompositions

$$\begin{aligned} \mathcal{E}_i &= \tilde{\mathcal{E}}_i \oplus \tilde{\mathcal{E}}'_i && (0 \leq i \leq n) \quad , \\ \mathcal{F}_i &= \tilde{\mathcal{F}}_i \oplus \tilde{\mathcal{F}}'_i && (0 \leq i \leq n) \quad . \end{aligned}$$

Since the bf-morphisms g_i and h_i respect these decompositions, we can write $g_i = \tilde{g}_i \oplus \tilde{g}'_i$ and $h_i = \tilde{h}_i \oplus \tilde{h}'_i$ where \tilde{g}_i (respectively $\tilde{g}'_i, \tilde{h}_i, \tilde{h}'_i$) is a bf-morphism from $\tilde{\mathcal{E}}_{i+1}$ to $\tilde{\mathcal{E}}_i$ (respectively from $\tilde{\mathcal{E}}'_{i+1}$ to $\tilde{\mathcal{E}}'_i$, from $\tilde{\mathcal{F}}_{i+1}$ to $\tilde{\mathcal{F}}_i$, from $\tilde{\mathcal{F}}'_{i+1}$ to $\tilde{\mathcal{F}}'_i$) for $0 \leq i \leq n - 1$. By the same reason, we can write $h_n = \tilde{h}_n \oplus \tilde{h}'_n$, where $\tilde{h}_n : \tilde{\mathcal{E}}_n \xrightarrow{\sim} \tilde{\mathcal{F}}$ and $\tilde{h}'_n : \tilde{\mathcal{E}}'_n \xrightarrow{\sim} \tilde{\mathcal{F}}'$. Observe that $\text{rk } \tilde{g}_i = 0$ and $\text{rk } \tilde{g}'_i = i$ for $0 \leq i \leq n - 1$ and that

$$\text{rk } \tilde{h}_i = \begin{cases} 0, & \text{if } i = 0 \\ 1, & \text{if } i > 0 \end{cases} \quad , \quad \text{rk } \tilde{h}'_i = \begin{cases} 0, & \text{if } i = 0 \\ i - 1, & \text{if } i > 0 \end{cases} \quad .$$

Now we define

$$\begin{aligned} \mathcal{L}' &:= \mathcal{L} \otimes \mathcal{L}_0^\vee \\ \mathcal{L}'_i &:= \mathcal{L}_{i+1} \quad , \quad \lambda'_i := \lambda_{i+1} \quad (0 \leq i \leq n-2) \\ \mathcal{M}'_i &:= \mathcal{M}_i \quad , \quad \mu'_i := \mu_i \quad (0 \leq i \leq n-2) \\ \mathcal{E}'_i &:= \tilde{\mathcal{E}}'_i \quad (0 \leq i \leq n-1) \\ \mathcal{F}'_i &:= \tilde{\mathcal{F}}'_{i+1} \quad (0 \leq i \leq n-1) \end{aligned}$$

where we identify \mathcal{E}'_0 with $\oplus^{n-1}\mathcal{O}_S$ via the isomorphism

$$\mathcal{E}'_0 = \tilde{\mathcal{E}}'_0 \xrightarrow{\text{inclusion}} \mathcal{E}_0 = \oplus^n \mathcal{O}_S \xrightarrow{\pi_{[2,n]}} \oplus^{n-1} \mathcal{O}_S \quad ,$$

and \mathcal{F}'_0 with $\oplus^{n-1}\mathcal{L}'$ via the isomorphism

$$\mathcal{F}'_0 = \tilde{\mathcal{F}}'_1 \xrightarrow{\wedge^1 \tilde{h}'_0} \mathcal{L}'_0 \otimes \oplus^{n-1} \mathcal{L} = \oplus^{n-1} \mathcal{L}' \quad .$$

Let

$$\begin{aligned} \Phi' &:= (\mathcal{L}'_i, \lambda'_i, \mathcal{M}'_i, \mu'_i, \mathcal{E}'_i \rightarrow \mathcal{M}'_i \otimes \mathcal{E}'_{i+1}, \mathcal{E}'_i \leftarrow \mathcal{E}'_{i+1}, \\ &\mathcal{F}'_{i+1} \rightarrow \mathcal{F}'_i, \mathcal{L}'_i \otimes \mathcal{F}'_{i+1} \leftarrow \mathcal{F}'_i \quad (0 \leq i \leq n-2), \mathcal{E}'_{n-1} \xrightarrow{\sim} \mathcal{F}'_{n-1}) \quad , \end{aligned}$$

where $\mathcal{E}'_{n-1} \xrightarrow{\sim} \mathcal{F}'_{n-1}$ is the composition

$$\mathcal{E}'_{n-1} = \tilde{\mathcal{E}}'_{n-1} \xrightarrow{\wedge^{-1} \tilde{g}'_{n-1}} \tilde{\mathcal{E}}'_n \xrightarrow{\tilde{h}'_n} \tilde{\mathcal{F}}'_n = \mathcal{F}'_{n-1} \quad ,$$

and where the other morphisms are the ones from the \tilde{g}'_i and the \tilde{h}'_i . It is easy to see that Φ' is a generalized isomorphism from $\oplus^{n-1}\mathcal{O}_S$ to $\oplus^{n-1}\mathcal{L}'$. Furthermore, it follows from 6.3 that

$$(\wedge^r \Phi')(e_1 \wedge \dots \wedge e_r) = (\wedge^1 \Phi')(e_1) \wedge (\wedge^{r-1} \Phi')(e'_1 \wedge \dots \wedge e'_{r-1}) \quad (2 \leq r \leq n) \quad ,$$

where $(e_1, \dots, e_n) \subset \Gamma(S, \mathcal{E}_0)$ and $(e'_1, \dots, e'_{n-1}) \subset \Gamma(S, \mathcal{E}'_0)$ are the canonical global frames of $\oplus^n \mathcal{O}_S$ and $\oplus^{n-1} \mathcal{O}_S$ respectively. Therefore we have

$$\det_{[1,r][1,r]} \Phi = \det_{\{1\}\{1\}} \Phi \otimes \det_{[1,r-1][1,r-1]} \Phi' \quad (2 \leq r \leq n) \quad .$$

Since, by assumption, the sections $\det_{[1,r][1,r]} \Phi$ are nowhere vanishing, the above equation implies that the same is true also for the sections $\det_{[1,r-1][1,r-1]} \Phi'$ ($2 \leq r \leq n$). In other words, (id, id) is admissible for Φ' . By induction-hypothesis, we conclude that there exists a diagonalization $(u'_i, v'_i, (0 \leq i \leq n-1), (\varphi'_1, \dots, \varphi'_{n-1}))$ of Φ' with respect to (id, id).

Let

$$\begin{aligned} \tilde{u}'_i &:= u'_i \quad (0 \leq i \leq n-1) \quad , \\ \tilde{v}'_i &:= v'_{i-1} \quad (1 \leq i \leq n) \quad , \end{aligned}$$

and

$$\begin{aligned} \tilde{u}'_n &: \tilde{\mathcal{E}}'_n \xrightarrow[\sim]{\tilde{g}'_{n-1}} \tilde{\mathcal{E}}'_{n-1} = \mathcal{E}'_{n-1} \xrightarrow[\sim]{u'_{n-1}} \bigoplus_{j=2}^n \left(\bigotimes_{\nu=0}^{n-j} \mathcal{M}^\vee \right) \quad , \\ \tilde{v}'_0 &: \tilde{\mathcal{F}}'_0 = \bigoplus^{n-1} \mathcal{L} = \mathcal{L}_0 \otimes \mathcal{F}'_0 \xrightarrow[\sim]{v'_0} \bigoplus^{n-1} \mathcal{L} \quad . \end{aligned}$$

Observe that there are natural isomorphisms

$$\begin{aligned} \tilde{u}_i &: \tilde{\mathcal{E}}_i \xrightarrow{\sim} \bigotimes_{j=0}^{i-1} \mathcal{M}_j^\vee \quad (0 \leq i \leq n) \\ \tilde{v}_i &: \tilde{\mathcal{F}}_i \xrightarrow{\sim} \bigotimes_{j=0}^{n-1} \mathcal{M}_j^\vee \xrightarrow{\det_{\{1\}\{1\}} \Phi} \mathcal{L} \otimes \mathcal{L}_0^\vee \quad (1 \leq i \leq n) \\ \tilde{v}_0 &: \tilde{\mathcal{F}}_0 \xrightarrow{\sim} \mathcal{L}_0 \otimes \bigotimes_{j=0}^{n-1} \mathcal{M}_j^\vee \xrightarrow{\det_{\{1\}\{1\}} \Phi} \mathcal{L} \end{aligned}$$

We set $u_i := \tilde{u}_i \oplus \tilde{u}'_i$, $v_i := \tilde{v}_i \oplus \tilde{v}'_i$ for $0 \leq i \leq n$, and $\varphi_r := \varphi'_{r-1}$ for $2 \leq r \leq n$. Finally, we let $\varphi_1 : \bigotimes_{i=0}^{n-1} \mathcal{M}_i^\vee \xrightarrow{\sim} \mathcal{L} \otimes \mathcal{L}_0^\vee$ be the isomorphism induced by $\det_{\{1\}\{1\}} \Phi$. It is now easy to see that the tuple $(u_i, v_i (0 \leq i \leq n), (\varphi_1, \dots, \varphi_n))$ is a diagonalization of Φ with respect to (id, id) . Conversely, assume that there exists a diagonalization $(u_i, v_i (0 \leq i \leq n), (\varphi_1, \dots, \varphi_n))$ of Φ with respect to (id, id) . Observe that the diagram

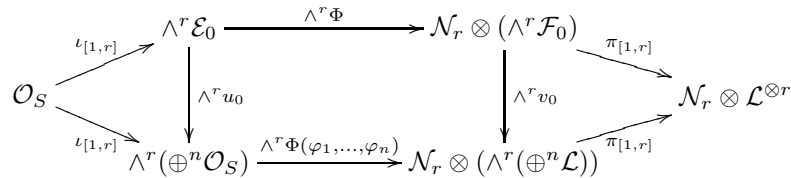

where $\mathcal{N}_r := \bigotimes_{\nu=1}^r (\bigotimes_{i=0}^{n-\nu} \mathcal{M}_i \otimes \bigotimes_{i=0}^{\nu-1} \mathcal{L}_i^\vee)$, is commutative for $1 \leq r \leq n$. Therefore we may assume that $\Phi = \Phi(\varphi_1, \dots, \varphi_n)$. But then $\det_{[1,r][1,r]} \Phi$ is the section induced by the isomorphism

$$\varphi_1 \otimes \dots \otimes \varphi_r : \bigotimes_{\nu=1}^r \bigotimes_{i=0}^{n-\nu} \mathcal{M}_i^\vee \xrightarrow{\sim} \bigotimes_{\nu=1}^r \bigotimes_{i=0}^{\nu-1} \mathcal{L}_i^\vee$$

for $1 \leq r \leq n$. In particular the $\det_{[1,r][1,r]} \Phi$ are nowhere vanishing on S , which is precisely what is required for the admissibility of (id, id) for Φ .

2. By 1, it suffices to show that in the case $S = \text{Spec } k$ (k a field) there exists a pair $(\alpha, \beta) \in S_n \times S_n$ which is admissible for Φ . We apply induction on n , the case $n = 1$ being trivial.

It is an easy exercise in linear algebra, to show that the morphism

$$\wedge^1 \Phi = (h_0^b)^{-1} \circ h_1^\sharp \dots \circ h_{n-1}^\sharp \circ h_n \circ g_{n-1}^b \circ \dots \circ g_0^b$$

has at least rank one. Consequently there exist indices $i_1, j_1 \in \{1, \dots, n\}$, such that the composition $\det_{\{i_1\}\{j_1\}} \Phi = \pi_{i_1} \circ (\wedge^1 \Phi) \circ \iota_{j_1}$ is an isomorphism. Let the sheaves $\tilde{\mathcal{E}}'_i, \tilde{\mathcal{F}}'_i$ ($0 \leq i \leq n$) be defined as on page 575, with π_1 replaced by π_{i_1} , and using these sheaves, let Φ' be defined as on page 576. This is a generalized isomorphism from k^{n-1} to $\bigoplus^{n-1} (\mathcal{L}_0^\vee \otimes \mathcal{L})$. By induction-hypothesis there exists a pair $(\alpha', \beta') \in S_{n-1} \times S_{n-1}$, which is admissible for Φ' . Let $\alpha \in S_n$ be defined by

$$\alpha(r) := \begin{cases} i_1, & \text{if } r = 1 \\ \alpha'(r-1) + 1, & \text{if } 2 \leq r \leq n \end{cases},$$

and let $\beta \in S_n$ be defined analogously. As on page 576 we have

$$\det_{\alpha[1,r], \beta[1,r]} \Phi = \det_{\{i_1\}\{j_1\}} \Phi \otimes \det_{\alpha'[1,r-1], \beta'[1,r-1]} \Phi' \quad (2 \leq r \leq n)$$

for $2 \leq r \leq n$, i.e. the pair (α, β) is admissible for Φ .

3. This follows from the proof of 1, since it is clear that the construction of the diagonalization there is unique. \square

PROPOSITION 7.4. *Let S be a scheme and Φ a generalized isomorphism from $\oplus^n \mathcal{O}_S$ to itself.*

1. *If $(\alpha, \beta) \in S_n \times S_n$ is admissible for Φ , then there exists a unique morphism $S \rightarrow X(\alpha, \beta)$, such that the pull-back of Φ_{univ} to S by this morphism is equivalent to Φ .*
2. *We have the following description of $X(\alpha, \beta)$ as an open subset of KGl_n :*

$$X(\alpha, \beta) = \{x \in KGl_n \mid (\det_{\alpha[1,r], \beta[1,r]} \Phi_{\text{univ}})(x) \neq 0 \text{ for } 1 \leq r \leq n\} \quad .$$
3. *If $(\alpha', \beta') \in S_n \times S_n$ is a further admissible pair for Φ , then the above morphism $S \rightarrow X(\alpha, \beta)$ factorizes over the inclusion $X(\alpha, \beta) \cap X(\alpha', \beta') \hookrightarrow X(\alpha, \beta)$.*

Proof. 1. Let

$$\begin{aligned} \Phi &= (\mathcal{L}_i, \lambda_i, \mathcal{M}_i, \mu_i, \mathcal{E}_i \rightarrow \mathcal{M}_i \otimes \mathcal{E}_{i+1}, \mathcal{E}_i \leftarrow \mathcal{E}_{i+1}, \\ &\quad \mathcal{F}_{i+1} \rightarrow \mathcal{F}_i, \mathcal{L}_i \otimes \mathcal{F}_{i+1} \leftarrow \mathcal{F}_i \quad (0 \leq i \leq n-1), \quad \mathcal{E}_n \xrightarrow{\sim} \mathcal{F}_n) . \end{aligned}$$

By proposition 7.3 there exists a diagonalization $(u_i, v_i \ (0 \leq i \leq n), (\varphi_1, \dots, \varphi_n))$ of Φ with respect to (α, β) . Let $a_{ji} \in \Gamma(S, \mathcal{O}_S)$ (respectively $b_{ij} \in \Gamma(S, \mathcal{O}_S)$) $(1 \leq i < j \leq n)$ be the nontrivial entries of the lower (respectively upper) triangular matrix $(v_0 \cdot n_\alpha)^{-1}$ (respectively $u_0 \cdot n_\beta$). Let $a : S \rightarrow U^-$ and $b : S \rightarrow U^+$ be the morphisms defined by $a^*(y_{ji}) = a_{ji}$ and $b^*(z_{ij}) = b_{ij}$ respectively. Furthermore, let $\varphi : S \rightarrow \tilde{T}$ be the morphism induced by the tuple

$$(\mathcal{L}_i, \lambda_i, \mathcal{M}_i, \mu_i \ (0 \leq i \leq n-1), \varphi_r \ (1 \leq r \leq n)) \quad ,$$

(cf lemma 4.3). Thus we have a morphism

$$f : S \xrightarrow{(a, \varphi, b)} U^- \times \tilde{T} \times U^+ \xrightarrow{\sim} X(\alpha, \beta) \quad ,$$

where the right isomorphism is the inverse of the one in lemma 4.4. It is clear that

$$\begin{aligned} f^* \mathcal{O}(Y_i(\alpha, \beta)) &\cong \mathcal{L}_i \quad , \quad f^* \mathbf{1}_{\mathcal{O}(Y_i(\alpha, \beta))} = \lambda_i \\ f^* \mathcal{O}(Z_i(\alpha, \beta)) &\cong \mathcal{M}_i \quad , \quad f^* \mathbf{1}_{\mathcal{O}(Z_i(\alpha, \beta))} = \mu_i \quad (0 \leq i \leq n-1) . \end{aligned}$$

Denote by $(u'_i, v'_i \ (0 \leq i \leq n), (\varphi'_1, \dots, \varphi'_n))$ the pull-back under f of the diagonalization of $\Phi_{\text{univ}}|_{X(\alpha, \beta)}$, which exists by 6.5 and 7.3. By the uniqueness of diagonalizations (cf 7.3), we have $u_0 = u'_0, v_0 = v'_0$ and $(\varphi_1, \dots, \varphi_n) = (\varphi'_1, \dots, \varphi'_n)$. Therefore the isomorphisms

$$\begin{aligned} (u'_i)^{-1} \circ u_i &: \mathcal{E}_i \xrightarrow{\sim} f^* E_i \\ (v'_i)^{-1} \circ v_i &: \mathcal{F}_i \xrightarrow{\sim} f^* F_i \end{aligned}$$

induce an equivalence between Φ and $f^* \Phi_{\text{univ}}$. This proves the existence part of the proposition. For uniqueness, assume that \tilde{f} is a further morphism from

S to $X(\alpha, \beta)$, such that Φ is equivalent to $\tilde{f}^*\Phi_{\text{univ}}$. Let $\bar{u}_i : \mathcal{E}_i \xrightarrow{\sim} \tilde{f}^*E_i$, $\bar{v}_i : \mathcal{F}_i \xrightarrow{\sim} \tilde{f}^*F_i$, ($0 \leq i \leq n$) be an equivalence. Note that by definition $\bar{u}_0 = \text{id}_{\oplus^n \mathcal{O}_S} = \bar{u}_0$. Let $(\tilde{u}_i, \tilde{v}_i$ ($0 \leq i \leq n$), $(\tilde{\varphi}_1, \dots, \tilde{\varphi}_n)$) be the pull-back under \tilde{f} of the diagonalization with respect to (α, β) of $\Phi_{\text{univ}}|_{X(\alpha, \beta)}$. Then $(\tilde{u}_i \circ \bar{u}_i, \tilde{v}_i \circ \bar{v}_i$ ($0 \leq i \leq n$), $(\tilde{\varphi}_1, \dots, \tilde{\varphi}_n)$) is a diagonalization of Φ with respect to (α, β) . By 7.3.3 we conclude that $\tilde{u}_0 = \tilde{u}_0 \circ \bar{u}_0 = u_0$, $\tilde{v}_0 = \tilde{v}_0 \circ \bar{v}_0 = v_0$ and $(\tilde{\varphi}_1, \dots, \tilde{\varphi}_n) = (\varphi_1, \dots, \varphi_n)$. But this implies that the composite morphism

$$S \xrightarrow{\tilde{f}} X(\alpha, \beta) \xrightarrow{\sim} U^- \times \tilde{T} \times U^+$$

equals (a, φ, b) and thus that $\tilde{f} = f$.

2. Denote for a moment by U the open subset of KGl_n , defined by the non-vanishing of $\det_{\alpha[1,r], \beta[1,r]} \Phi_{\text{univ}}$ for $1 \leq r \leq n$. We have already seen in 6.5 that $X(\alpha, \beta)$ is contained in U . Let $x \in U$. Since $X(\alpha, \beta)$ is dense in U , there exists a generalization $y \in X(\alpha, \beta)$ of x . Then there exists a morphism $f : S \rightarrow U$, where S is the Spec of a valuation ring, such that the special point of S is mapped to x and its generic point to y . By definition of U , the pair (α, β) is admissible for the generalized isomorphism $f^*\Phi_{\text{univ}}$. Therefore 1 tells us that there exists a morphism $f' : S \rightarrow X(\alpha, \beta)$, which coincides with f at the generic point of S . Since KGl_n is separabel, it follows that $f = f'$ and thus that $x \in X(\alpha, \beta)$.

3. This follows immediately from 2. □

Proof. (Of theorem 5.5). Let S be a scheme and Φ a generalized isomorphism from $\oplus^n \mathcal{O}_S$ to itself. By proposition 7.3, there is a covering of S by open sets U_i ($i \in I$), and for every index $i \in I$ a pair $(\alpha_i, \beta_i) \in S_n \times S_n$, which is admissible for $\Phi|_{U_i}$. Proposition 7.4.1 now tells us that there exists for each $i \in I$ a unique morphism $f_i : U_i \rightarrow X(\alpha_i, \beta_i)$ with the property that there is an equivalence, say u_i , from $\Phi|_{U_i}$ to $f_i^*\Phi_{\text{univ}}$. By proposition 7.4.2, the f_i glue together, to give a morphism $f : S \rightarrow \text{KGl}_n$. It remains to show that also the u_i glue together, to give an overall equivalence from Φ to $f^*\Phi_{\text{univ}}$. For this, it suffices to show that for two generalized isomorphisms Φ and Φ' from $\oplus^n \mathcal{O}_S$ to itself there exists at most one equivalence from Φ to Φ' . The question being local, we may assume by proposition 7.3.2 that Φ' is diagonalizable with respect to some pair $(\alpha, \beta) \in S_n \times S_n$. Composing the diagonalization of Φ' with any equivalence from Φ to Φ' gives a diagonalization of Φ with respect to (α, β) . Since different equivalences from Φ to Φ' would yield different diagonalizations of Φ , proposition 7.3.3 tells us that there exists at most one equivalence. □

8. COMPLETE COLLINEATIONS

In this section we prove a modular property for the compactification $\overline{\text{PGL}}_n$ of PGL_n and compare it with the results of other authors.

The scheme $\overline{\text{PGL}}_n$ together with closed subschemes $\overline{\Delta}_r$ ($1 \leq r \leq n-1$) is defined by successive blow ups as follows. Let $\overline{\Omega}^{(0)} := \text{Proj}(\mathbb{Z}[x_{i,j}$ ($1 \leq i, j \leq n$)) and let $\overline{\Delta}_r^{(0)} := V^+((\det_{AB}(x_{ij}) \mid A, B \subseteq \{1, \dots, n\}, \#A = \#B = r + 1))$ ($1 \leq$

$r \leq n - 1$). Inductively, define $\overline{\Omega}^{(\nu)}$ as the blowing up of $\overline{\Omega}^{(\nu-1)}$ along $\overline{\Delta}_\nu^{(\nu-1)}$. The closed subscheme $\overline{\Delta}_r^{(\nu)} \subset \overline{\Omega}^{(\nu)}$ is by definition the strict (resp. total) transform of $\overline{\Delta}_r^{(\nu-1)}$ for $r \neq \nu$ (resp. $r = \nu$). By definition, $\overline{\text{PGL}}_n := \overline{\Omega}^{(n-1)}$ and $\overline{\Delta}_r := \overline{\Delta}_r^{(n-1)}$ for $1 \leq r \leq n - 1$.

The variety $\overline{\text{PGL}}_n \times \text{Spec}(\mathbb{C})$ is the so-called “wonderful compactification” of the homogenous space $\text{PGL}_{n,\mathbb{C}} = (\text{PGL}_{n,\mathbb{C}} \times \text{PGL}_{n,\mathbb{C}}) / \text{PGL}_{n,\mathbb{C}}$ (cf. [CP]). Vainsencher [V], Laksov [Lak2] and Thorup-Kleiman [TK] have given a modular description for (some of) the S -valued points of $\overline{\text{PGL}}_n$. We will give a brief account of their results.

Let $R \subseteq [1, n - 1]$ and let S be a scheme. Following the terminology of Vainsencher, an S -valued *complete collineation of type R* from a rank- n vector bundle E to a rank- n vector bundle F is a collection of morphisms

$$v_i : E_i \rightarrow \mathcal{N}_i \otimes F_i \quad (0 \leq i \leq k),$$

where $R = \{r_1, \dots, r_k\}$, $0 =: r_0 < r_1 < \dots < r_k < r_{k+1} := n$, the \mathcal{N}_i are line bundles, the E_i, F_i are vector bundles on S and v_i has overall rank $r_{i+1} - r_i$; furthermore it is required that $E_0 = E, F_0 = F$, and $E_i = \ker(v_{i-1}), F_i = \mathcal{N}_{i-1}^\vee \otimes \text{coker}(v_{i-1})$ for $1 \leq i \leq k$. Vainsencher proves that the locally closed subscheme $(\cap_{r \in R} \overline{\Delta}_r) \setminus \cup_{r \notin R} \overline{\Delta}_r$ of $\overline{\text{PGL}}_n$ represents the functor which to each scheme S associates the set of isomorphism classes of S -valued complete collineations of type R from $\oplus^n \mathcal{O}_S$ to itself.

Laksov went further. He succeeded to give a modular description for those S -valued points of $\overline{\Delta}(R) := \cap_{r \in R} \overline{\Delta}_r$ for which the pull-back of the divisor $\sum_{r \notin R} \overline{\Delta}_r|_{\overline{\Delta}(R)}$ on $\overline{\Delta}(R)$ is a well-defined divisor on S . We refer the reader to [Lak2] for more details.

Finally, Thorup and Kleiman gave the following description for *all* S -valued points of $\overline{\text{PGL}}_n$. A morphism u from $(\oplus^n \mathcal{O}_S) \otimes (\oplus^n \mathcal{O}_S)^\vee$ to a line bundle \mathcal{L} is called a *divisorial form*, if for each $i \in [1, n]$ the image $\mathcal{M}_i(u)$ of the induced map $\wedge^i(\oplus^n \mathcal{O}_S) \otimes \wedge^i(\oplus^n \mathcal{O}_S)^\vee \rightarrow \mathcal{L}^{\otimes i}$ is an invertible sheaf. In this case denote by u^i the induced surjection $\wedge^i(\oplus^n \mathcal{O}_S) \otimes \wedge^i(\oplus^n \mathcal{O}_S)^\vee \rightarrow \mathcal{M}_i(u)$. Following Thorup and Kleiman, we define a *projectively complete bilinear form* as a tuple $\mathbf{u} = (u_1, \dots, u_n)$, where $u_i : \wedge^i(\oplus^n \mathcal{O}_S) \otimes \wedge^i(\oplus^n \mathcal{O}_S)^\vee \rightarrow \mathcal{M}_i$ is a surjection onto an invertible sheaf \mathcal{M}_i for $1 \leq i \leq n$, such that \mathbf{u} is “locally the pull-back of a divisorial form”. The last requirement means the following: For each point $x \in S$, there exists an open neighborhood U of x , a morphism from U to some scheme S' and a divisorial form $u : (\oplus^n \mathcal{O}_{S'}) \otimes (\oplus^n \mathcal{O}_{S'})^\vee \rightarrow \mathcal{L}'$ on S' such that the restriction of \mathbf{u} to U is isomorphic to the pull-back of (u^1, \dots, u^n) . Thorup and Kleiman show that $\overline{\text{PGL}}_n$ represents the functor that to each scheme S associates the set of isomorphism classes of projectively complete bilinear forms on S .

None of these descriptions is completely satisfactory: Those of Vainsencher and Laksov deal only with special S -valued points and the description of Thorup-Kleiman is not explicit and is not truly modular, since the condition “to

be locally pull-back of a divisorial form” makes reference to the existence of morphisms between schemes.

The terminology in the following definition will be justified by the corollary 8.2 below.

DEFINITION 8.1. Let S be a scheme and \mathcal{E}, \mathcal{F} two locally free \mathcal{O}_S -modules of rank n . A *complete collineation* from \mathcal{E} to \mathcal{F} is a tuple

$$\Psi = (\mathcal{L}_i, \lambda_i, \mathcal{F}_{i+1} \rightarrow \mathcal{F}_i, \mathcal{L}_i \otimes \mathcal{F}_{i+1} \leftarrow \mathcal{F}_i \ (0 \leq i \leq n - 1)) \quad ,$$

where $\mathcal{E} = \mathcal{F}_n, \mathcal{F}_{n-1}, \dots, \mathcal{F}_1, \mathcal{F}_0 = \mathcal{F}$ are locally free \mathcal{O}_S -modules of rank n , the tuples

$$(\mathcal{L}_i, \lambda_i, \mathcal{F}_{i+1} \rightarrow \mathcal{F}_i, \mathcal{L}_i \otimes \mathcal{F}_{i+1} \leftarrow \mathcal{F}_i, i)$$

are bf-morphisms of rank i for $0 \leq i \leq n - 1$ and $\lambda_0 = 0$, such that for each point $x \in S$ and index $i \in \{0, \dots, n - 1\}$ with the property that $\lambda_i(x) = 0$, the following holds:

If (f, g) is one of the following two pairs of morphisms:

$$\begin{aligned} \mathcal{F}_n[x] &\xrightarrow{f} \mathcal{F}_{i+1}[x] \xrightarrow{g} \mathcal{F}_i[x] \ , \\ ((\otimes_{j=0}^i \mathcal{L}_j) \otimes \mathcal{F}_{i+1})[x] &\xleftarrow{g} ((\otimes_{j=0}^{i-1} \mathcal{L}_j) \otimes \mathcal{F}_i)[x] \xleftarrow{f} \mathcal{F}_0[x] \ , \end{aligned}$$

then $\text{im}(g \circ f) = \text{im}(g)$.

Two complete collineations Ψ and Ψ' from \mathcal{E} to \mathcal{F} are called *equivalent*, if there are isomorphisms $\mathcal{L}_i \xrightarrow{\sim} \mathcal{L}'_i, \mathcal{F}_i \xrightarrow{\sim} \mathcal{F}'_i$, such that all the obvious diagrams commute and such that $\mathcal{F}_n \xrightarrow{\sim} \mathcal{F}'_n$ and $\mathcal{F}_0 \xrightarrow{\sim} \mathcal{F}'_0$ is the identity on \mathcal{E} and \mathcal{F} .

COROLLARY 8.2. On $\overline{\text{PGL}}_n$ there exists a universal complete collineation Ψ_{univ} from $\oplus^n \mathcal{O}$ to itself, such that the pair $(\overline{\text{PGL}}_n, \Psi_{\text{univ}})$ represents the functor, which to every scheme S associates the set of equivalence classes of complete collineations from $\oplus^n \mathcal{O}_S$ to itself.

Proof. Observe that $\overline{\text{PGL}}_n$ is naturally isomorphic to the closed subscheme Y_0 of KGL_n . The restriction of Φ_{univ} to $\overline{\text{PGL}}_n$ induces in an obvious way a complete collineation Ψ_{univ} of $\oplus^n \mathcal{O}$ to itself on $\overline{\text{PGL}}_n$. The corollary now follows from theorem 5.5. □

We conclude this section by indicating how one can recover Vainsencher’s and Thorup-Kleiman’s description from corollary 8.2. Let S be a scheme and let

$$\Psi = (\mathcal{L}_i, \lambda_i, \mathcal{F}_{i+1} \rightarrow \mathcal{F}_i, \mathcal{L}_i \otimes \mathcal{F}_{i+1} \leftarrow \mathcal{F}_i \ (0 \leq i \leq n - 1))$$

be a complete collineation from $\oplus^n \mathcal{O}_S$ to itself in the sense of definition 8.1. First assume that there exists a subset R of $[1, n - 1]$, such that the map $S \rightarrow \overline{\text{PGL}}_n$ corresponding to Ψ factors through $(\cap_{r \in R} \overline{\Delta}_r) \setminus \cup_{r \notin R} \overline{\Delta}_r$. This means that λ_r is zero for $r \in R$ and is nowhere vanishing for $r \in [1, n - 1] \setminus R$. As above, let $R = \{r_1, \dots, r_k\}, 0 =: r_0 < r_1 < \dots < r_k < r_{k+1} := n$. For $0 \leq i \leq k$ let

$$\begin{aligned} E_i &:= \ker(\mathcal{F}_n \rightarrow \mathcal{F}_{n-1} \rightarrow \dots \rightarrow \mathcal{F}_{r_i}) \\ F_i &:= \mathcal{N}_i^\vee \otimes \ker(\mathcal{F}_{r_{i+1}} \rightarrow \mathcal{F}_{r_{i+1}-1} \rightarrow \dots \rightarrow \mathcal{F}_{r_i}) \quad , \end{aligned}$$

where $\mathcal{N}_i := \otimes_{j=1}^i \mathcal{L}_{r_i}^\vee$. Observe that the data in Ψ provide natural maps

$$v_i : E_i \rightarrow \mathcal{N}_i \otimes F_i$$

of overall rank $r_{i+1} - r_i$ for $0 \leq i \leq k$. Furthermore we have natural isomorphisms $E_0 = \mathcal{F}_n = \oplus^n \mathcal{O}$, $F_0 \cong \mathcal{F}_0 = \oplus^n \mathcal{O}$, and for $1 \leq i \leq k$:

$$\begin{aligned} \ker(v_{i-1}) &= E_i \\ \operatorname{coker}(v_{i-1}) &\cong \operatorname{coker}(\mathcal{F}_n \rightarrow \mathcal{F}_{r_i}) = \operatorname{coker}(\mathcal{F}_{r_{i+1}} \rightarrow \mathcal{F}_{r_i}) \cong \\ &\cong \ker(\mathcal{L}_{r_i} \otimes \mathcal{F}_{r_{i+1}} \rightarrow \mathcal{L}_{r_i} \otimes \mathcal{F}_{r_i}) \cong \mathcal{N}_{i-1} \otimes F_i \quad . \end{aligned}$$

Thus, $(v_i)_{0 \leq i \leq k}$ is a complete homomorphism of type R in the sense of Vainsencher.

Now let Ψ be arbitrary. As in section 6, Ψ induces nowhere vanishing morphisms

$$\wedge^r \Psi : \wedge^r \mathcal{F}_n \rightarrow \left(\bigotimes_{\nu=1}^r \bigotimes_{i=0}^{\nu-1} \mathcal{L}_i^\vee \right) \otimes \wedge^r \mathcal{F}_0$$

and thus surjections

$$u_r : \wedge^r \mathcal{F}_n \otimes \wedge^r \mathcal{F}_0^\vee \rightarrow \bigotimes_{\nu=1}^r \bigotimes_{i=0}^{\nu-1} \mathcal{L}_i^\vee$$

for $1 \leq r \leq n$. The tuple $(u_r)_{1 \leq r \leq n}$ is a projectively complete bilinear form in the sense of Thorup-Kleiman. This follows from the fact that $\wedge^1 \Psi_{\text{univ}}$ induces a divisorial form on $\overline{\text{PGL}}_n$.

9. GEOMETRY OF THE STRATA

In this section we need relative versions of the varieties $\text{KGL}_n, \overline{\text{PGL}}_n$ and $\overline{\mathcal{O}}_{I,J} := \cap_{i \in I} Z_i \cap \cap_{j \in J} Y_j$, where I and J are subsets of $[0, n - 1]$. They are defined in the following theorem.

THEOREM 9.1. *Let T be a scheme and let \mathcal{E} and \mathcal{F} be two locally free \mathcal{O}_T -modules of rank n . For a T -scheme S we write \mathcal{E}_S and \mathcal{F}_S for the pull-back of \mathcal{E} and \mathcal{F} to S . Let I, J be two subsets of $[0, n - 1]$. Consider the following contravariant functors from the category of T -schemes to the category of sets:*

$$\begin{aligned} \text{KGL}(\mathcal{E}, \mathcal{F}) : S &\mapsto \left\{ \begin{array}{l} \text{equivalence classes of} \\ \text{generalized isomorphisms} \\ \text{from } \mathcal{E}_S \text{ to } \mathcal{F}_S \end{array} \right\} \\ \overline{\text{PGL}}(\mathcal{E}, \mathcal{F}) : S &\mapsto \left\{ \begin{array}{l} \text{equivalence classes of} \\ \text{complete collineations} \\ \text{from } \mathcal{E}_S \text{ to } \mathcal{F}_S \end{array} \right\} \\ \overline{\mathcal{O}}_{I,J}(\mathcal{E}, \mathcal{F}) : S &\mapsto \left\{ \begin{array}{l} \text{equivalence classes of} \\ \text{generalized isomorphisms } \Phi \\ \text{as in definition 5.2 from} \\ \mathcal{E}_S \text{ to } \mathcal{F}_S, \text{ with } \mu_i = 0 \text{ for } i \in I \\ \text{and } \lambda_j = 0 \text{ for } j \in J \end{array} \right\} \end{aligned}$$

These functors are representable by smooth projective T -schemes, which we will call $\text{KGl}(\mathcal{E}, \mathcal{F})$, $\overline{\text{PGl}}(\mathcal{E}, \mathcal{F})$ and $\overline{\mathcal{O}}_{I,J}(\mathcal{E}, \mathcal{F})$ respectively.

Proof. In the case of $T = \text{Spec } \mathbb{Z}$ and $\mathcal{E} = \mathcal{F} = \bigoplus^n \mathcal{O}_{\text{Spec } \mathbb{Z}}$, the theorem is a consequence of 5.5 and 8.2, where the representing objects are KGl_n , $\overline{\text{PGl}}_n$ and $\overline{\mathcal{O}}_{I,J}$ respectively. Let $T = \cup U_i$ an open covering such that there exist trivializations

$$\begin{aligned} \xi_i &: \mathcal{E}|_{U_i} \xrightarrow{\sim} \bigoplus^n \mathcal{O}_{U_i} \\ \zeta_i &: \mathcal{F}|_{U_i} \xrightarrow{\sim} \bigoplus^n \mathcal{O}_{U_i} \end{aligned}$$

Let $\text{KGl}_{U_i} := \text{KGl}_n \times_{\text{Spec } \mathbb{Z}} U_i$ and $\pi_i : \text{KGl}_{U_i} \rightarrow U_i$ the projection. By corollary 5.6, over the intersections $U_i \cap U_j$ the pairs $(\xi_i \xi_j^{-1}, \zeta_i \zeta_j^{-1})$ induce isomorphisms $\pi_i^{-1}(U_i \cap U_j) \xrightarrow{\sim} \pi_j^{-1}(U_i \cap U_j)$. These provide the data for the pieces KGl_{U_i} to glue together to define $\text{KGl}(\mathcal{E}, \mathcal{F})$. Using theorem 5.5 it is easy to check that $\text{KGl}(\mathcal{E}, \mathcal{F})$ has the required universal property. This proves the existence of $\text{KGl}(\mathcal{E}, \mathcal{F})$. The existence of $\overline{\text{PGl}}(\mathcal{E}, \mathcal{F})$ and of $\overline{\mathcal{O}}_{I,J}(\mathcal{E}, \mathcal{F})$ is proved analogously. \square

DEFINITION 9.2. Let T be a scheme and \mathcal{E} a locally free \mathcal{O}_T -module of rank n . Let $\mathbf{d} := (d_0, \dots, d_t)$, where $0 \leq d_0 \leq \dots \leq d_t \leq n$. Let $\text{Fl}^{\mathbf{d}}(\mathcal{E})$ be the flag variety which represents the following contravariant functor from the category of T -schemes to the category of sets:

$$S \mapsto \left\{ \begin{array}{l} \text{All filtrations } F_0\mathcal{E} \subseteq \dots \subseteq F_t\mathcal{E}, \text{ where} \\ F_p\mathcal{E} \text{ is a subbundle of rank } d_p \text{ of } \mathcal{E}_S \\ \text{for } 0 \leq p \leq t \end{array} \right\}$$

Here as usual, a subbundle of \mathcal{E}_S means a locally free subsheaf of \mathcal{E}_S , which is locally a direct summand.

After these preliminaries we can state the main result of this section, which describes the structure of the schemes $\overline{\mathcal{O}}_{I,J}$ defined above.

THEOREM 9.3. *Let T be a scheme and let \mathcal{E} and \mathcal{F} be two locally free \mathcal{O}_T -modules of rank n . Let $I := \{i_1, \dots, i_r\}$ and $J := \{j_1, \dots, j_s\}$, where $i_1 + j_1 \geq n$ and $0 \leq i_1 < \dots < i_{r+1} := n$, $0 \leq j_1 < \dots < j_{s+1} := n$. Let $\mathbf{d} := (d_0, \dots, d_{r+s+1})$ and $\boldsymbol{\delta} := (\delta_0, \dots, \delta_{r+s+1})$, where*

$$d_p := \begin{cases} n - j_{s+1-p} & \text{for } 0 \leq p \leq s \\ i_{p-s} & \text{for } s+1 \leq p \leq r+s+1 \end{cases}$$

and $\delta_q := n - d_{r+s+1-q}$ for $0 \leq q \leq r+s+1$. Let

$$\begin{aligned} 0 &= U_0 \subseteq U_1 \subseteq \dots \subseteq U_{r+s+1} = \mathcal{E}_{\text{Fl}^{\mathbf{d}}(\mathcal{E}) \times \text{Fl}^{\boldsymbol{\delta}}(\mathcal{F})} \\ \text{and } 0 &= V_0 \subseteq V_1 \subseteq \dots \subseteq V_{r+s+1} = \mathcal{F}_{\text{Fl}^{\mathbf{d}}(\mathcal{E}) \times \text{Fl}^{\boldsymbol{\delta}}(\mathcal{F})} \end{aligned}$$

be the pull back to $\text{Fl}^{\mathbf{d}}(\mathcal{E}) \times \text{Fl}^{\boldsymbol{\delta}}(\mathcal{F})$ of the universal flag on $\text{Fl}^{\mathbf{d}}(\mathcal{E})$ and $\text{Fl}^{\boldsymbol{\delta}}(\mathcal{F})$ respectively. Then there is a natural isomorphism

$$\overline{\mathcal{O}}_{I,J}(\mathcal{E}, \mathcal{F}) \xrightarrow{\sim} P_1 \times_{\text{Fl}} \dots \times_{\text{Fl}} P_r \times_{\text{Fl}} Q_s \times_{\text{Fl}} \dots \times_{\text{Fl}} Q_1 \times_{\text{Fl}} K' \quad ,$$

where $Fl := Fl^{\mathbf{d}}(\mathcal{E}) \times Fl^{\delta}(\mathcal{F})$ and where

$$\begin{aligned} P_p &:= \overline{PGL}(V_{r-p+1}/V_{r-p}, U_{s+p+1}/U_{s+p}) \quad (1 \leq p \leq r) \\ Q_q &:= \overline{PGL}(U_{s-q+1}/U_{s-q}, V_{r+q+1}/V_{r+q}) \quad (1 \leq q \leq s) \\ K' &:= KGL(U_{s+1}/U_s, V_{r+1}/V_r) \quad . \end{aligned}$$

Proof. The isomorphism

$$\overline{O}_{I,J} \cong P_1 \times_{F_1} \dots \times P_r \times_{F_1} Q_s \times_{F_1} \dots \times Q_1 \times_{F_1} K'$$

is given on S -valued points by the bijectiv correspondence

$$\Phi \longleftrightarrow ((F_{\bullet}\mathcal{E}, F_{\bullet}\mathcal{F}), \varphi_1, \dots, \varphi_r, \psi_s, \dots, \psi_1, \Phi') \quad ,$$

where

$$\Phi = \left(\begin{array}{ccccccc} \begin{array}{c} \begin{array}{ccc} \mathcal{E}_S & \xleftarrow{0} & \mathcal{E}_1 & \xleftarrow{1} & \mathcal{E}_2 & \cdots & \mathcal{E}_{n-1} & \xleftarrow{n-1} & \mathcal{E}_n & \xrightarrow{\sim} & \mathcal{F}_n & \xrightarrow{n-1} & \mathcal{F}_{n-1} & \cdots & \mathcal{F}_2 & \xrightarrow{1} & \mathcal{F}_1 & \xrightarrow{0} & \mathcal{F}_S \end{array} \\ \begin{array}{cccccccccccccccc} (\mathcal{M}_0, \mu_0) & & (\mathcal{M}_1, \mu_1) & & & & (\mathcal{M}_{n-1}, \mu_{n-1}) & & & & (\mathcal{L}_{n-1}, \lambda_{n-1}) & & & & & & (\mathcal{L}_1, \lambda_1) & & (\mathcal{L}_0, \lambda_0) \end{array} \end{array} \end{array} \right)$$

is a generalized isomorphism from \mathcal{E}_S to \mathcal{F}_S with $\mu_i = \lambda_j = 0$ for $i \in I$ and $j \in J$,

$$\begin{aligned} F_{\bullet}\mathcal{E} &= (0 = F_0\mathcal{E} \subseteq \dots \subseteq F_{r+s+1}\mathcal{E} = \mathcal{E}_S) \\ \text{and} \quad F_{\bullet}\mathcal{F} &= (0 = F_0\mathcal{F} \subseteq \dots \subseteq F_{r+s+1}\mathcal{F} = \mathcal{F}_S) \end{aligned}$$

are flags of type \mathbf{d} and δ in \mathcal{E}_S and \mathcal{F}_S respectively,

$$\varphi_p = \left(\begin{array}{ccc} \begin{array}{ccc} \mathcal{E}_0^{(p)} & \xleftarrow{0} & \mathcal{E}_1^{(p)} \\ (\mathcal{M}_0^{(p)}, \mu_0^{(p)}) & & (\mathcal{M}_1^{(p)}, \mu_1^{(p)}) \end{array} & \cdots & \begin{array}{ccc} \mathcal{E}_{m_p-1}^{(p)} & \xleftarrow{m_p} & \mathcal{E}_{m_p}^{(p)} \\ (\mathcal{M}_{m_p}^{(p)}, \mu_{m_p}^{(p)}) & & \end{array} \end{array} \right)$$

is a complete collineation from $\mathcal{E}_{m_p}^{(p)} = F_{r-p+1}\mathcal{F}/F_{r-p}\mathcal{F}$ to $\mathcal{E}_0^{(p)} = F_{s+p+1}\mathcal{E}/F_{s+p}\mathcal{E}$ for $1 \leq p \leq r$,

$$\psi_q = \left(\begin{array}{ccc} \begin{array}{ccc} \mathcal{F}_{n_q}^{(q)} & \xrightarrow{n_q} & \mathcal{F}_{n_q-1}^{(q)} \\ (\mathcal{L}_{n_q}^{(q)}, \lambda_{n_q}^{(q)}) & & (\mathcal{L}_{n_q-1}^{(q)}, \lambda_{n_q-1}^{(q)}) \end{array} & \cdots & \begin{array}{ccc} \mathcal{F}_1^{(q)} & \xrightarrow{0} & \mathcal{F}_0^{(q)} \\ (\mathcal{L}_0^{(q)}, \lambda_0^{(q)}) & & \end{array} \end{array} \right)$$

is a complete collineation from $\mathcal{F}_{n_q}^{(q)} = F_{s-q+1}\mathcal{F}/F_{s-q}\mathcal{E}$ to $\mathcal{F}_0^{(q)} = F_{r+q+1}\mathcal{F}/F_{r+q}\mathcal{F}$ for $s \geq q \geq 1$ and $\Phi' =$

$$\left(\begin{array}{ccccccc} \begin{array}{c} \begin{array}{ccc} \mathcal{E}'_0 & \xleftarrow{0} & \mathcal{E}'_1 & \xleftarrow{1} & \mathcal{E}'_2 & \cdots & \mathcal{E}'_{n'-1} & \xleftarrow{n'-1} & \mathcal{E}'_{n'} & \xrightarrow{\sim} & \mathcal{F}'_{n'} & \xrightarrow{n'-1} & \mathcal{F}'_{n'-1} & \cdots & \mathcal{F}'_2 & \xrightarrow{1} & \mathcal{F}'_1 & \xrightarrow{0} & \mathcal{F}'_0 \end{array} \\ \begin{array}{cccccccccccccccc} (\mathcal{M}'_0, \mu'_0) & & (\mathcal{M}'_1, \mu'_1) & & & & (\mathcal{M}'_{n'-1}, \mu'_{n'-1}) & & & & (\mathcal{L}'_{n'-1}, \lambda'_{n'-1}) & & & & & & (\mathcal{L}'_1, \lambda'_1) & & (\mathcal{L}'_0, \lambda'_0) \end{array} \end{array} \end{array} \right)$$

is a generalized isomorphism from $\mathcal{E}'_0 = F_{s+1}\mathcal{E}/F_s\mathcal{E}$ to $\mathcal{F}'_0 = F_{r+1}\mathcal{F}/F_r\mathcal{F}$.

The mapping

$$\Phi \mapsto ((F_{\bullet}\mathcal{E}, F_{\bullet}\mathcal{F}), \varphi_1, \dots, \varphi_r, \psi_s, \dots, \psi_1, \Phi')$$

is defined as follows: Let Φ as above be given. For convenience we set $\mathcal{E}_{n+1} := \mathcal{F}_n$, $\mathcal{F}_{n+1} := \mathcal{E}_n$ and we let $\mathcal{F}_{n+1} \rightarrow \mathcal{F}_n$ and $\mathcal{E}_n \leftarrow \mathcal{E}_{n+1}$ be the isomorphism $\mathcal{E}_n \xrightarrow{\sim} \mathcal{F}_n$ and its inverse respectively, whereas we let $\mathcal{E}_n \twoheadrightarrow \mathcal{E}_{n+1}$

we have a natural isomorphism $\mathcal{E}_0^{(p)} = F_{s+p+1}\mathcal{E}/F_{s+p}\mathcal{E} \xrightarrow{\sim} \mathcal{M}_0^{(p)} \otimes \mathcal{E}_1^{(p)}$. We define $\mathcal{E}_0^{(p)} \leftarrow \mathcal{E}_1^{(p)}$ to be the zero morphism. Thus we have a bf-morphism $\mathcal{E}_0^{(p)} \xleftarrow[\otimes]{0} \mathcal{E}_1^{(p)}$ of rank zero. For $1 \leq k \leq m_p - 1$ let $\mathcal{E}_k^{(p)} \xleftarrow[\otimes]{k} \mathcal{E}_{k+1}^{(p)}$ be

the bf-morphism induced by the bf-morphism $\mathcal{E}_{i_p+k} \xleftarrow[\otimes]{i_p+k} \mathcal{E}_{i_p+k+1}$. Observe

that $\ker(\mathcal{E}_{i_p+1} \twoheadrightarrow \mathcal{E}_{i_p+1+1}) = \text{im}(\mathcal{E}_{i_p+1} \leftarrow \mathcal{E}_n) = \mathcal{E}_n / \ker(\mathcal{E}_{i_p+1} \leftarrow \mathcal{E}_n)$ and that the morphism $\mathcal{E}_n \rightarrow \mathcal{F}_S$ maps $\ker(\mathcal{E}_{i_p} \leftarrow \mathcal{E}_n)$ injectively into \mathcal{F}_S . Therefore we have a natural isomorphism $\mathcal{E}_{m_p}^{(p)} \cong F_{r-p+1}\mathcal{F}/F_{r-p}\mathcal{F}$ by which we identify these two sheaves. It is not difficult to see that

$$\varphi_p := \left(\mathcal{E}_0^{(p)} \xleftarrow[\otimes]{0} \mathcal{E}_1^{(p)} \quad \dots \quad \mathcal{E}_{m_p-1}^{(p)} \xleftarrow[\otimes]{m_p} \mathcal{E}_{m_p}^{(p)} \right)$$

is a complete collineation in the sense of 8.1 from $\mathcal{E}_{m_p}^{(p)} = F_{r-p+1}\mathcal{F}/F_{r-p}\mathcal{F}$ to $\mathcal{E}_0^{(p)} = F_{s+p+1}\mathcal{E}/F_{s+p}\mathcal{E}$. In a completely symmetric way the generalized isomorphism Φ induces also complete collineations

$$\psi_q = \left(\mathcal{F}_{n_q}^{(q)} \xrightarrow[\otimes]{n_q} \mathcal{F}_{n_q-1}^{(q)} \quad \dots \quad \mathcal{F}_1^{(q)} \xrightarrow[\otimes]{0} \mathcal{F}_0^{(p)} \right)$$

from $\mathcal{F}_{n_q}^{(q)} = F_{s-q+1}\mathcal{F}/F_{s-q}\mathcal{E}$ to $\mathcal{F}_0^{(q)} = F_{r+q+1}\mathcal{F}/F_{r+q}\mathcal{F}$ for $s \geq q \geq 1$. It remains to construct the generalized isomorphism Φ' . We set

$$\begin{aligned} \mathcal{E}'_k &:= \ker(\mathcal{E}_{n-j_1+k} \twoheadrightarrow \mathcal{E}_{i_1+1}) / \text{im}(\mathcal{E}_{n-j_1+k} \leftarrow \ker(\mathcal{E}_n \rightarrow \mathcal{F}_{j_1})) \\ \mathcal{F}'_k &:= \ker(\mathcal{F}_{j_1+1} \twoheadrightarrow \mathcal{F}_{n-i_1+k}) / \text{im}(\ker(\mathcal{E}_{i_1} \leftarrow \mathcal{F}_n) \rightarrow \mathcal{F}_{n-i_1+k}) \end{aligned}$$

for $0 \leq k \leq n' := i_1 + j_1 - n$ and

$$\begin{aligned} \mathcal{M}'_k &:= \mathcal{M}_{n-j_1+k}, & \mu'_k &:= \mu_{n-j_1+k} \\ \mathcal{L}'_k &:= \mathcal{L}_{n-i_1+k}, & \lambda'_k &:= \lambda_{n-i_1+k} \end{aligned}$$

for $0 \leq k \leq n' - 1$. It is then clear that the \mathcal{E}'_k and \mathcal{F}'_k are locally free of rank $n' = i_1 + j_1 - n$. It follows from definition 5.2.2. that the μ_i and λ_j are nowhere vanishing for $0 \leq i \leq n - j_1 - 1$ and $n - i_1 - 1 \geq j \geq 0$. Therefore we may identify \mathcal{E}_i with \mathcal{E}_S and \mathcal{F}_j with \mathcal{F}_S for $0 \leq i \leq n - j_1 - 1$ and $n - i_1 - 1 \geq j \geq 0$ respectively. This implies in particular that we have $\mathcal{E}'_0 = F_{s+1}\mathcal{E}/F_s\mathcal{E}$ and $\mathcal{F}'_0 = F_{r+1}\mathcal{F}/F_r\mathcal{F}$. Let

$$\mathcal{E}'_k \xleftarrow[\otimes]{k} \mathcal{E}'_{k+1} \quad \text{and} \quad \mathcal{F}'_{k+1} \xrightarrow[\otimes]{k} \mathcal{F}'_k$$

be the bf-morphisms induced by the bf-morphisms

$$\mathcal{E}_{n-j_1+k} \begin{array}{c} \xrightarrow{\circledast} \\ \xleftarrow{n-j_1+k} \\ \mathcal{E}_{n-j_1+k+1} \\ (\mathcal{M}_{n-j_1+k, \mu_{n-j_1+k}}) \end{array} \quad \text{and} \quad \mathcal{F}_{n-i_1+k+1} \begin{array}{c} \xleftarrow{\circledast} \\ \xrightarrow{n-i_1+k} \\ \mathcal{F}_{n-i_1+k} \\ (\mathcal{L}_{n-i_1+k, \lambda_{n-i_1+k}}) \end{array}$$

respectively. We have

$$\ker(\mathcal{E}_{i_1} \twoheadrightarrow \mathcal{E}_{i_1+1}) = \text{im}(\mathcal{E}_{i_1} \leftarrow \mathcal{E}_n) = \mathcal{E}_n / \ker(\mathcal{E}_{i_1} \leftarrow \mathcal{E}_n)$$

and therefore

$$\mathcal{E}'_{n'} = \mathcal{E}_n / (\ker(\mathcal{E}_{i_1} \leftarrow \mathcal{E}_n) + \ker(\mathcal{E}_n \rightarrow \mathcal{F}_{j_1})) \quad .$$

By the same argument:

$$\mathcal{F}'_{n'} = \mathcal{F}_n / (\ker(\mathcal{E}_{i_1} \leftarrow \mathcal{F}_n) + \ker(\mathcal{F}_n \rightarrow \mathcal{F}_{j_1})) \quad .$$

Thus the isomorphism $\mathcal{E}_n \xrightarrow{\sim} \mathcal{F}_n$ induces an isomorphism $\mathcal{E}'_{n'} \xrightarrow{\sim} \mathcal{F}'_{n'}$. Again it is not difficult to check that $\Phi' :=$

$$\left(\begin{array}{ccccccc} \mathcal{E}'_0 & \xleftarrow{0} & \mathcal{E}'_1 & \xleftarrow{1} & \mathcal{E}'_2 & \cdots & \mathcal{E}'_{n'-1} & \xleftarrow{n'-1} & \mathcal{E}'_{n'} & \xrightarrow{\sim} & \mathcal{F}'_{n'-1} & \xrightarrow{n'-1} & \mathcal{F}'_{n'-1} & \cdots & \mathcal{F}'_2 & \xrightarrow{1} & \mathcal{F}'_1 & \xrightarrow{0} & \mathcal{F}'_0 \\ (\mathcal{M}'_0, \mu'_0) & & (\mathcal{M}'_1, \mu'_1) & & & & (\mathcal{M}'_{n'-1}, \mu'_{n'-1}) & & & & (\mathcal{L}'_{n'-1}, \lambda'_{n'-1}) & & & & & (\mathcal{L}'_1, \lambda'_1) & & (\mathcal{L}'_0, \lambda'_0) & & \end{array} \right)$$

is a generalized isomorphism from $\mathcal{E}'_0 = F_{s+1}\mathcal{E}/F_s\mathcal{E}$ to $\mathcal{F}'_0 = F_{r+1}\mathcal{F}/F_r\mathcal{F}$. This completes the construction of the mapping

$$\Phi \mapsto ((F_\bullet\mathcal{E}, F_\bullet\mathcal{F}), \varphi_1, \dots, \varphi_r, \psi_s, \dots, \psi_1, \Phi') \quad .$$

We proceed by constructing the inverse of this mapping. Let data $((F_\bullet\mathcal{E}, F_\bullet\mathcal{F}), \varphi_1, \dots, \varphi_r, \psi_s, \dots, \psi_1, \Phi')$ be given. Let $\mathcal{E}_i := \mathcal{E}_S$ and $\mathcal{F}_j := \mathcal{F}_S$ for $0 \leq i \leq n - j_1$ and $n - i_1 \geq j \geq 0$ respectively. Now let $n - j_1 + 1 \leq i \leq i_1$ and $j_1 \geq j \geq n - i_1 + 1$. Let $\tilde{\mathcal{E}}_i$ and $\tilde{\mathcal{F}}_j$ be defined by the cartesian diagrams

$$\begin{array}{ccc} \tilde{\mathcal{E}}_i & \longrightarrow & \mathcal{E}'_{i+j_1-n} \\ \downarrow & & \downarrow \\ F_{s+1}\mathcal{E} & \twoheadrightarrow & F_{s+1}\mathcal{E}/F_s\mathcal{E} \end{array} \quad \text{and} \quad \begin{array}{ccc} \tilde{\mathcal{F}}_j & \longrightarrow & \mathcal{F}'_{j+i_1-n} \\ \downarrow & & \downarrow \\ F_{r+1}\mathcal{F} & \twoheadrightarrow & F_{r+1}\mathcal{F}/F_r\mathcal{F} \end{array}$$

respectively. For a moment let $\mathcal{M} := \bigotimes_{k=0}^{i+j_1-n-1} \mathcal{M}'_k$. We have a commutative diagram

$$\begin{array}{ccc} \mathcal{M}^\vee \otimes F_{s+1}\mathcal{E} & \longrightarrow & \mathcal{E}'_{i+j_1-n} \\ \downarrow & & \downarrow \\ F_{s+1}\mathcal{E} & \twoheadrightarrow & F_{s+1}\mathcal{E}/F_s\mathcal{E} \end{array} \quad (*)$$

where the left vertical arrow is induced by $\bigotimes_{k=0}^{i+j_1-n-1} \mu'_k : \mathcal{O}_S \rightarrow \mathcal{M}$ and the upper horizontal arrow is the composition

$$\mathcal{M}^\vee \otimes F_{s+1}\mathcal{E} \rightarrow \mathcal{M}^\vee \otimes F_{s+1}\mathcal{E}/F_s\mathcal{E} = \mathcal{M}^\vee \otimes \mathcal{E}'_0 \rightarrow \mathcal{E}'_{i+j_1-n}$$

The diagram (*) induces a morphism $\mathcal{M}^\vee \otimes F_{s+1}\mathcal{E} \rightarrow \tilde{\mathcal{E}}_i$. Analogously, we have a morphism $\mathcal{L}^\vee \otimes F_{r+1}\mathcal{F} \rightarrow \tilde{\mathcal{F}}_j$, where we have employed the abbreviation $\mathcal{L} := \bigotimes_{k=0}^{j+i_1-n-1} \mathcal{L}'_k$. Let \mathcal{E}_i and \mathcal{F}_j be defined by the cocartesian diagrams

$$\begin{array}{ccc} \mathcal{M}^\vee \otimes F_{s+1}\mathcal{E} & \hookrightarrow & \mathcal{M}^\vee \otimes \mathcal{E}_S \\ \downarrow & & \downarrow \\ \tilde{\mathcal{E}}_i & \longrightarrow & \mathcal{E}_i \end{array} \quad \text{and} \quad \begin{array}{ccc} \mathcal{L}^\vee \otimes F_{r+1}\mathcal{F} & \hookrightarrow & \mathcal{L}^\vee \otimes \mathcal{F}_S \\ \downarrow & & \downarrow \\ \tilde{\mathcal{F}}_j & \longrightarrow & \mathcal{F}_j \end{array}$$

respectively.

We define $\mathcal{E}_n = \mathcal{F}_n$ by the cartesian diagram

$$\begin{array}{ccc} \mathcal{E}_n = \mathcal{F}_n & \longrightarrow & \tilde{\mathcal{F}}_{j_1} \\ \downarrow & & \downarrow \\ \tilde{\mathcal{E}}_{i_1} & \longrightarrow & \mathcal{E}'_{i_1+j_1-n} \xrightarrow{\cong} \mathcal{F}'_{i_1+j_1-n} \end{array}$$

Observe that the composed morphism $\mathcal{E}_n \rightarrow \tilde{\mathcal{E}}_{i_1} \rightarrow F_{s+1}\mathcal{E}$ maps the submodule $\ker(\mathcal{E}_n \rightarrow \tilde{\mathcal{F}}_{j_1})$ of \mathcal{E}_n isomorphically onto the submodule $F_s\mathcal{E}$ of $F_{s+1}\mathcal{E}$. Therefore we have canonical injections

$$F_p\mathcal{E} \hookrightarrow F_s\mathcal{E} \xrightarrow{\sim} \ker(\mathcal{E}_n \rightarrow \tilde{\mathcal{F}}_{j_1}) \hookrightarrow \mathcal{E}_n$$

for $0 \leq p \leq s$. Analogously, we have canonical injections

$$F_q\mathcal{F} \hookrightarrow F_r\mathcal{F} \xrightarrow{\sim} \ker(\mathcal{F}_n \rightarrow \tilde{\mathcal{E}}_{i_1}) \hookrightarrow \mathcal{F}_n$$

for $0 \leq q \leq r$.

Now let $1 \leq p \leq r$, $i_p + 1 \leq i \leq i_{p+1}$ and $s \geq q \geq 1$, $j_{q+1} \geq j \geq j_q + 1$. We want to define \mathcal{E}_i and \mathcal{F}_j in this case. Let first $\tilde{\mathcal{E}}_i$ and $\tilde{\mathcal{F}}_j$ be defined by the cocartesian diagrams

$$\begin{array}{ccc} \mathcal{M}^\vee \otimes F_{s+p+1}\mathcal{E}/F_{s+p}\mathcal{E} & \twoheadrightarrow & \mathcal{E}_{i-i_p}^{(p)} \\ \downarrow & & \downarrow \\ \mathcal{M}^\vee \otimes \mathcal{E}_S/F_{s+p}\mathcal{E} & \longrightarrow & \tilde{\mathcal{E}}_i \end{array} \quad \text{and} \quad \begin{array}{ccc} \mathcal{L}^\vee \otimes F_{r+q+1}\mathcal{F}/F_{r+q}\mathcal{E} & \twoheadrightarrow & \mathcal{F}_{j-j_q}^{(q)} \\ \downarrow & & \downarrow \\ \mathcal{L}^\vee \otimes \mathcal{F}_S/F_{r+q}\mathcal{F} & \longrightarrow & \tilde{\mathcal{F}}_j \end{array}$$

where we have set $\mathcal{M} := \bigotimes_{k=0}^{i-i_p-1} \mathcal{M}_k^{(p)}$ and $\mathcal{L} := \bigotimes_{k=0}^{j-j_q-1} \mathcal{L}_k^{(q)}$. Let furthermore $\hat{\mathcal{E}}_i$ and $\hat{\mathcal{F}}_j$ be defined by the cocartesian diagrams

$$\begin{array}{ccc} F_{r-p+1}\mathcal{F}/F_{r-p}\mathcal{F} & \twoheadrightarrow & \mathcal{E}_{i-i_p}^{(p)} \\ \downarrow & & \downarrow \\ \mathcal{F}_n/F_{r-p}\mathcal{F} & \longrightarrow & \hat{\mathcal{E}}_i \end{array} \quad \text{and} \quad \begin{array}{ccc} F_{s-q+1}\mathcal{E}/F_{s-q}\mathcal{E} & \twoheadrightarrow & \mathcal{F}_{j-j_q}^{(q)} \\ \downarrow & & \downarrow \\ \mathcal{E}_n/F_{s-q}\mathcal{E} & \longrightarrow & \hat{\mathcal{F}}_j \end{array}$$

Now we define \mathcal{E}_i and \mathcal{F}_j by the cocartesian diagrams

$$\begin{array}{ccc} \mathcal{E}_{i-i_p}^{(p)} & \longrightarrow & \tilde{\mathcal{E}}_i \\ \downarrow & & \downarrow \\ \hat{\mathcal{E}}_i & \longrightarrow & \mathcal{E}_i \end{array} \quad \text{and} \quad \begin{array}{ccc} \mathcal{F}_{j-j_q}^{(q)} & \longrightarrow & \tilde{\mathcal{F}}_j \\ \downarrow & & \downarrow \\ \hat{\mathcal{F}}_j & \longrightarrow & \mathcal{F}_j \end{array}$$

respectively. For $p = r$ and $i = i_{r+1} = n$ this gives formally a new definition of \mathcal{E}_n , but it is clear that we have a canonical isomorphism between the two \mathcal{E}_n 's. A similar remark applies to \mathcal{F}_n .

We define the invertible sheaves \mathcal{M}_i together with their respective sections μ_i as follows:

$$\begin{aligned} \mathcal{M}_i &:= \mathcal{O}_S, \quad \mu_i := 1 \quad (0 \leq i \leq n - j_1 - 1) \\ \mathcal{M}_i &:= \mathcal{M}'_{i+j_1-n}, \quad \mu_i := \mu'_{i+j_1-n} \quad (n - j_1 \leq i \leq i_1 - 1) \\ \mathcal{M}_i &:= \mathcal{M}_{i-i_p}^{(p)}, \quad \mu_i := \mu_{i-i_p}^{(p)} \quad (1 \leq p \leq r, \quad i_p < i < i_{p+1}) \end{aligned}$$

$$\begin{aligned} \mathcal{M}_{i_1} &:= \mathcal{M}_0^{(1)} \otimes \bigotimes_{k=0}^{i_1+j_1-n-1} (\mathcal{M}'_k)^\vee, \quad \mu_{i_1} := 0 \\ \mathcal{M}_{i_p} &:= \mathcal{M}_0^{(p)} \otimes \bigotimes_{k=0}^{i_p-i_{p-1}-1} (\mathcal{M}_k^{(p-1)})^\vee, \quad \mu_{i_p} := 0 \quad (2 \leq p \leq r) \end{aligned}$$

Let the \mathcal{L}_j and λ_j be defined symmetrically (i.e. by replacing in the above definition the letter \mathcal{M} with \mathcal{L} , μ with λ , i with j , j with i and r with s). It remains to define the bf-morphisms

$$\begin{array}{ccc} \mathcal{E}_i & \xleftarrow{i} & \mathcal{E}_{i+1} \\ & \curvearrowright \otimes & \\ & (\mathcal{M}_i, \mu_i) & \end{array} \quad \text{and} \quad \begin{array}{ccc} \mathcal{F}_{j+1} & \xrightarrow{j} & \mathcal{F}_j \\ & \curvearrowright \otimes & \\ & (\mathcal{L}_j, \lambda_j) & \end{array}$$

for $n - j_1 \leq i \leq n - 1$ and $n - 1 \geq j \geq n - i_1$. Again we restrict ourselves to the left hand side, since the right hand side is obtained by the symmetric construction. For $n - j_1 \leq i \leq i_1 - 1$ (respectively for $1 \leq p \leq r$, $i_p \leq$

$i \leq i_{p+1} - 1$) the bf-morphism $\mathcal{E}_i \xleftarrow{\otimes} \mathcal{E}_{i+1}$ is induced in an obvious way

by the bf-morphism $\mathcal{E}'_{i+j_1-n} \xleftarrow{\otimes} \mathcal{E}'_{i+j_1-n+1}$ (respectively by the bf-morphism

$\mathcal{E}_{i-i_p}^{(p)} \xleftarrow{\otimes} \mathcal{E}_{i-i_{p+1}}^{(p)}$). For the definition of the bf-morphism $\mathcal{E}_{i_1} \xleftarrow{\otimes} \mathcal{E}_{i_1+1}$

consider the two canonical exact sequences

$$\begin{aligned} 0 &\longrightarrow \tilde{\mathcal{E}}_{i_1} \longrightarrow \mathcal{E}_{i_1} \longrightarrow \mathcal{M}^\vee \otimes \mathcal{E}_S / F_{s+1} \mathcal{E} \longrightarrow 0 \\ 0 &\longrightarrow \tilde{\mathcal{E}}_{i_1+1} \longrightarrow \mathcal{E}_{i_1+1} \longrightarrow \hat{\mathcal{E}}_{i_1+1} / \mathcal{E}_1^{(1)} \longrightarrow 0 \end{aligned}$$

where $\mathcal{M} := \bigotimes_{k=0}^{i_1-1} \mathcal{M}_k$. Observe that we have canonical isomorphisms

$$\begin{aligned} \tilde{\mathcal{E}}_{i_1} &\xrightarrow[\cong]{a} \mathcal{F}_n/F_r\mathcal{F} \xrightarrow[\cong]{b} \hat{\mathcal{E}}_{i_1+1}/\mathcal{E}_1^{(1)} \\ \tilde{\mathcal{E}}_{i_1+1} &\xrightarrow[\cong]{c} \mathcal{M}_{i_1}^\vee \otimes \mathcal{M}^\vee \otimes \mathcal{E}_S/F_{s+1}\mathcal{E} \end{aligned}$$

The isomorphism a follows from the observation we made after the definition of $\mathcal{E}_n = \mathcal{F}_n$, namely that the composed morphism $\mathcal{F}_n \rightarrow \tilde{\mathcal{F}}_{j_1} \rightarrow F_{r+1}\mathcal{F}$ maps $\ker(\mathcal{E}_n \rightarrow \tilde{\mathcal{E}}_{i_1})$ isomorphically to $F_r\mathcal{F}$. The isomorphism b comes from the fact that for $i = i_1 + 1$ the left vertical arrow in the defining diagram for $\hat{\mathcal{E}}_i$ vanishes, and the isomorphism c follows since for $i = i_1 + 1$ the left vertical arrow in the defining diagram for $\tilde{\mathcal{E}}_i$ is an isomorphism. Thus we have morphisms

$$\begin{aligned} \mathcal{E}_{i_1} &\longrightarrow \mathcal{M}^\vee \otimes \mathcal{E}_S/F_{s+1} \xrightarrow{c^{-1}} \mathcal{M}_{i_1} \otimes \tilde{\mathcal{E}}_{i_1+1} \hookrightarrow \mathcal{M}_{i_1} \otimes \mathcal{E}_{i_1+1} \\ \mathcal{E}_{i_1} &\longleftarrow \tilde{\mathcal{E}}_{i_1} \xleftarrow{a^{-1}b^{-1}} \hat{\mathcal{E}}_{i_1+1}/\mathcal{E}_1^{(1)} \longleftarrow \mathcal{E}_{i_1+1} \end{aligned}$$

which make up the bf-morphism $\mathcal{E}_{i_1} \overset{\otimes}{\longleftarrow} \mathcal{E}_{i_1+1}$. For $2 \leq p \leq r$ the bf-morphism $\mathcal{E}_{i_p} \overset{\otimes}{\longleftarrow} \mathcal{E}_{i_p+1}$ is constructed similarly from the exact sequences

$$\begin{aligned} 0 &\longrightarrow \hat{\mathcal{E}}_{i_p} \longrightarrow \mathcal{E}_{i_p} \longrightarrow \tilde{\mathcal{E}}_{i_p}/\mathcal{E}_{i_p-i_{p-1}}^{(p-1)} \longrightarrow 0 \\ 0 &\longrightarrow \tilde{\mathcal{E}}_{i_p+1} \longrightarrow \mathcal{E}_{i_p+1} \longrightarrow \hat{\mathcal{E}}_{i_p+1}/\mathcal{E}_1^{(p)} \longrightarrow 0 \end{aligned}$$

and the canonical isomorphisms

$$\begin{aligned} \hat{\mathcal{E}}_{i_p} &\xrightarrow[\cong]{} \mathcal{F}_n/F_{r-p+1}\mathcal{F} \xrightarrow[\cong]{} \hat{\mathcal{E}}_{i_p+1}/\mathcal{E}_1^{(p)} \\ \tilde{\mathcal{E}}_{i_p+1} &\xrightarrow[\cong]{} \mathcal{M}_{i_p}^\vee \otimes \mathcal{M}^\vee \otimes \mathcal{E}/F_{s+p}\mathcal{E} \xrightarrow[\cong]{} \mathcal{M}_{i_p}^\vee \otimes \tilde{\mathcal{E}}_{i_p}/\mathcal{E}_{i_p-i_{p-1}}^{(p-1)} \end{aligned}$$

where $\mathcal{M} := \bigotimes_{k=0}^{i_p-1} \mathcal{M}_k$. This completes the construction of

$$\Phi = \left(\begin{array}{cccc} \mathcal{E}_S & \overset{\otimes}{\longleftarrow} \mathcal{E}_1 & \overset{\otimes}{\longleftarrow} \mathcal{E}_2 & \cdots \\ \text{(\mathcal{M}_0, \mu_0)} & \text{(\mathcal{M}_1, \mu_1)} & & \end{array} \quad \cdots \quad \begin{array}{ccc} \mathcal{E}_{n-1} & \overset{\otimes}{\longleftarrow} \mathcal{E}_n & \xrightarrow{\sim} \mathcal{F}_n \\ \text{(\mathcal{M}_{n-1}, \mu_{n-1})} & & \text{(\mathcal{L}_{n-1}, \lambda_{n-1})} \end{array} \quad \cdots \quad \begin{array}{ccc} \mathcal{F}_2 & \overset{\otimes}{\longleftarrow} \mathcal{F}_1 & \overset{\otimes}{\longleftarrow} \mathcal{F}_S \\ \text{(\mathcal{L}_1, \lambda_1)} & \text{(\mathcal{L}_0, \lambda_0)} & \end{array} \right)$$

It is not difficult to see that Φ is a generalized isomorphism from \mathcal{E}_S to \mathcal{F}_S and that the mapping $((F_\bullet\mathcal{E}, F_\bullet\mathcal{F}), \varphi_1, \dots, \varphi_r, \psi_s, \dots, \psi_1, \Phi') \mapsto \Phi$ is inverse to the mapping $\Phi \mapsto ((F_\bullet\mathcal{E}, F_\bullet\mathcal{F}), \varphi_1, \dots, \varphi_r, \psi_s, \dots, \psi_1, \Phi')$ constructed before. We leave the details to the reader. \square

In the situation of theorem 9.3 we denote by $\text{Gl}(\mathcal{E})$ the group scheme over T , whose S -valued points are the automorphisms of \mathcal{E}_S . There is a natural left

operation of $\mathrm{Gl}(\mathcal{E}) \times_T \mathrm{Gl}(\mathcal{F})$ on $\mathrm{KGl}(\mathcal{E}, \mathcal{F})$, which is given on S -valued points by

$$(f, g) \left(\begin{array}{ccc} \mathcal{E}_S \xleftarrow[u^\#]{u^b} \mathcal{E}_1 & \cdots & \mathcal{F}_1 \xrightarrow[v^\#]{v^b} \mathcal{F}_S \end{array} \right) := \left(\begin{array}{ccc} \mathcal{E}_S \xleftarrow[f \circ u^\#]{u^b \circ f^{-1}} \mathcal{E}_1 & \cdots & \mathcal{F}_1 \xrightarrow[g \circ v^\#]{v^b \circ g^{-1}} \mathcal{F}_S \end{array} \right)$$

COROLLARY 9.4. *The orbits of the $\mathrm{Gl}(\mathcal{E}) \times_T \mathrm{Gl}(\mathcal{F})$ -operation on $\mathrm{KGl}(\mathcal{E}, \mathcal{F})$ are the locally closed subvarieties*

$$O_{I,J}(\mathcal{E}, \mathcal{F}) := \overline{O}_{I,J}(\mathcal{E}, \mathcal{F}) \setminus \left(\bigcup_{i \notin I} Z_i(\mathcal{E}, \mathcal{F}) \cup \bigcup_{j \notin J} Y_j(\mathcal{E}, \mathcal{F}) \right) ,$$

where $I, J \subseteq [0, n - 1]$ with $\min I + \min J \geq n$, and where $Z_i(\mathcal{E}, \mathcal{F}) := \overline{O}_{\{i\}, \emptyset}(\mathcal{E}, \mathcal{F})$ and $Y_j(\mathcal{E}, \mathcal{F}) := \overline{O}_{\emptyset, \{j\}}(\mathcal{E}, \mathcal{F})$.

Proof. The S -valued points of $O_{I,J}(\mathcal{E}, \mathcal{F})$ are the generalized isomorphisms

$$\Phi = \left(\begin{array}{ccccccc} \mathcal{E}_S \xleftarrow[\mathcal{M}_0, \mu_0]{0} \mathcal{E}_1 \xleftarrow[\mathcal{M}_1, \mu_1]{1} \mathcal{E}_2 & \cdots & \mathcal{E}_{n-1} \xleftarrow[\mathcal{M}_{n-1}, \mu_{n-1}]{n-1} \mathcal{E}_n \xrightarrow[\mathcal{L}_{n-1}, \lambda_{n-1}]{n-1} \mathcal{F}_n \xrightarrow[\mathcal{L}_{n-1}, \lambda_{n-1}]{n-1} \mathcal{F}_{n-1} & \cdots & \mathcal{F}_2 \xrightarrow[\mathcal{L}_1, \lambda_1]{1} \mathcal{F}_1 \xrightarrow[\mathcal{L}_0, \lambda_0]{0} \mathcal{F}_S \end{array} \right)$$

where $\mu_i = \lambda_j = 0$ for $i \in I$ and $j \in J$ and where μ_i, λ_j are nowhere vanishing for $i \notin I, j \notin J$. It is clear that $O_{I,J}(\mathcal{E}, \mathcal{F})$ is invariant under the operation of $\mathrm{Gl}(\mathcal{E}) \times_T \mathrm{Gl}(\mathcal{F})$. From the proof of theorem 9.3 it follows that we have the following isomorphism

$$O_{I,J}(\mathcal{E}, \mathcal{F}) \cong \overset{\circ}{P}_{\mathrm{Fl}1} \times \cdots \times \overset{\circ}{P}_{\mathrm{Fl}r} \times \overset{\circ}{Q}_{\mathrm{Fl}1} \times \cdots \times \overset{\circ}{Q}_{\mathrm{Fl}1} \times \overset{\circ}{K}' ,$$

where

$$\begin{aligned} \overset{\circ}{P}_p &:= \mathrm{PGL}(V_{r-p+1}/V_{r-p}, U_{s+p+1}/U_{s+p}) \quad (1 \leq p \leq r) \\ \overset{\circ}{Q}_q &:= \mathrm{PGL}(U_{s-q+1}/U_{s-q}, V_{r+q+1}/V_{r+q}) \quad (1 \leq q \leq s) \\ \overset{\circ}{K}' &:= \mathrm{Isom}(U_{s+1}/U_s, V_{r+1}/V_r) . \end{aligned}$$

There is a left $\mathrm{Gl}(\mathcal{E}) \times_T \mathrm{Gl}(\mathcal{F})$ -operation on the right-hand side of this isomorphism, given on S -valued points by

$$\begin{aligned} (f, g)((F_\bullet \mathcal{E}, F_\bullet \mathcal{F}), \varphi_1, \dots, \varphi_r, \psi_s, \dots, \psi_1, \Phi') &:= \\ ((f(F_\bullet \mathcal{E}), g(F_\bullet \mathcal{F})), f^{-1}\varphi_1 g, \dots, f^{-1}\varphi_r g, g\psi_s f^{-1}, \dots, g\psi_1 f^{-1}, g\Phi' f^{-1}), \end{aligned}$$

where φ_p is an isomorphism (up to multiplication by an invertible section of \mathcal{O}_S) from $F_{r-p+1}\mathcal{F}/F_{r-p}\mathcal{F}$ to $F_{s+p+1}\mathcal{E}/F_{s+p}\mathcal{E}$ for $1 \leq p \leq r$, ψ_q an isomorphism (up to multiplication by an invertible section of \mathcal{O}_S) from $F_{s-q+1}\mathcal{E}/F_{s-q}\mathcal{E}$ to $F_{r+q+1}\mathcal{F}/F_{r+q}\mathcal{F}$ for $s \geq q \geq 1$ and Φ' is an isomorphism from $F_{s+1}\mathcal{E}/F_s\mathcal{E}$ to $F_{r+1}\mathcal{F}/F_r\mathcal{F}$. It is easy to see that this operation is transitive and that the isomorphism

$$O_{I,J}(\mathcal{E}, \mathcal{F}) \cong \overset{\circ}{P}_{\mathrm{Fl}1} \times \cdots \times \overset{\circ}{P}_{\mathrm{Fl}r} \times \overset{\circ}{Q}_{\mathrm{Fl}1} \times \cdots \times \overset{\circ}{Q}_{\mathrm{Fl}1} \times \overset{\circ}{K}' ,$$

is $\mathrm{Gl}(\mathcal{E}) \times_T \mathrm{Gl}(\mathcal{F})$ -equivariant. □

10. A MORPHISM OF KGL_n ONTO THE GRASSMANNIAN COMPACTIFICATION OF THE GENERAL LINEAR GROUP

Let V be an n -dimensional vector space over some field. As mentioned in the introduction, there is another natural compactification of the general linear group $\mathrm{Gl}(V)$: The Grassmannian $\mathrm{Gr}_n(V \oplus V)$ of n -dimensional subspaces of a $V \oplus V$ -dimensional vector space. The embedding $\mathrm{Gl}(V) \hookrightarrow \mathrm{Gr}_n(V \oplus V)$ is given by associating to an automorphism $V \xrightarrow{\sim} V$ its graph in $V \oplus V$. We will see in this section that there exists a natural morphism from $\mathrm{KGl}(V)$ to $\mathrm{Gr}_n(V \oplus V)$. Our motivation here is to obtain a better understanding of the relation between the Gieseker-type degeneration of moduli spaces of vector bundles and the torsion-free sheaves approach as developed in [NS] and [S2]. As in the previous section, we work over an arbitrary base scheme T . Let \mathcal{E}, \mathcal{F} be two locally free \mathcal{O}_T -modules of rank n . Denote by $\mathrm{Gr}_n(\mathcal{E} \oplus \mathcal{F})$ the Grassmanian variety over T which parametrizes subbundles of rank n of $\mathcal{E} \oplus \mathcal{F}$. Let S be a T -scheme and let

$$\Phi = \left(\begin{array}{ccccccc} \begin{array}{c} \mathcal{E}_S \xleftarrow{0} \mathcal{E}_1 \xleftarrow{1} \mathcal{E}_2 \\ (\mathcal{M}_0, \mu_0) \quad (\mathcal{M}_1, \mu_1) \end{array} & \cdots & \begin{array}{c} \mathcal{E}_{n-1} \xleftarrow{n-1} \mathcal{E}_n \\ (\mathcal{M}_{n-1}, \mu_{n-1}) \end{array} & \xrightarrow{\sim} & \begin{array}{c} \mathcal{F}_n \xrightarrow{n-1} \mathcal{F}_{n-1} \\ (\mathcal{L}_{n-1}, \lambda_{n-1}) \end{array} & \cdots & \begin{array}{c} \mathcal{F}_2 \xrightarrow{1} \mathcal{F}_1 \xrightarrow{0} \mathcal{F}_S \\ (\mathcal{L}_1, \lambda_1) \quad (\mathcal{L}_0, \lambda_0) \end{array} \end{array} \right)$$

be a generalized isomorphism from \mathcal{E}_S to \mathcal{F}_S . By 5.2.2, the morphism $\mathcal{E}_n \rightarrow \mathcal{E}_S \oplus \mathcal{F}_S$ induced by the two composed morphisms

$$\begin{array}{c} \mathcal{E}_n \rightarrow \mathcal{E}_{n-1} \rightarrow \cdots \rightarrow \mathcal{E}_1 \rightarrow \mathcal{E}_S \\ \mathcal{E}_n \xrightarrow{\sim} \mathcal{F}_n \rightarrow \mathcal{F}_{n-1} \rightarrow \cdots \rightarrow \mathcal{F}_1 \rightarrow \mathcal{F}_S \end{array}$$

is a subbundle of $\mathcal{E}_S \oplus \mathcal{F}_S$. Let

$$\mathrm{KGl}(\mathcal{E}, \mathcal{F}) \rightarrow \mathrm{Gr}_n(\mathcal{E} \oplus \mathcal{F})$$

be the morphism, which on S -valued points is given by $\Phi \mapsto (\mathcal{E}_n \rightarrow \mathcal{E}_S \oplus \mathcal{F}_S)$. Observe that the following diagram commutes

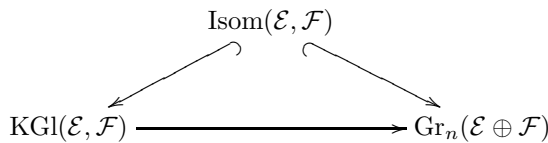

and that furthermore all the arrows in this diagram are equivariant with respect to the natural action of $\mathrm{Gl}(\mathcal{E}) \times_T \mathrm{Gl}(\mathcal{F})$ on the three schemes. In the next proposition we compute the fibres of the morphism $\mathrm{KGl}(\mathcal{E}, \mathcal{F}) \rightarrow \mathrm{Gr}_n(\mathcal{E} \oplus \mathcal{F})$.

PROPOSITION 10.1. *Let S' be a T -scheme and let $\mathcal{H} \hookrightarrow \mathcal{E}_{S'} \oplus \mathcal{F}_{S'}$ be an S' -valued point of $\mathrm{Gr}_n(\mathcal{E}, \mathcal{F})$ such that $\mathrm{im}(\mathcal{H} \rightarrow \mathcal{E}_{S'})$ and $\mathrm{im}(\mathcal{H} \rightarrow \mathcal{F}_{S'})$ are subbundles of $\mathcal{E}_{S'}$ and $\mathcal{F}_{S'}$ respectively. Then the fibre product*

$$\mathrm{KGl}(\mathcal{E}, \mathcal{F}) \times_{\mathrm{Gr}_n(\mathcal{E} \oplus \mathcal{F})} S'$$

is isomorphic to

$$\overline{PGL}(\ker(\mathcal{H} \rightarrow \mathcal{E}_{S'}), \operatorname{coker}(\mathcal{H} \rightarrow \mathcal{E}_{S'})) \times_{S'} \overline{PGL}(\ker(\mathcal{H} \rightarrow \mathcal{F}_{S'}), \operatorname{coker}(\mathcal{H} \rightarrow \mathcal{F}_{S'})),$$

where by convention $\overline{PGL}(\mathcal{N}, \mathcal{N}) := S'$ for the zero-sheaf $\mathcal{N} = 0$ on S' .

Proof. Let S be an S' -scheme. An S -valued point of the fibre product $\operatorname{KGl}(\mathcal{E}, \mathcal{F}) \times_{\operatorname{Gr}_n(\mathcal{E} \oplus \mathcal{F})} S'$ is given by a generalized isomorphism

$$\Phi = \left(\begin{array}{ccccccc} \mathcal{E}_S & \xleftarrow[0]{\otimes} \mathcal{E}_1 & \xleftarrow[1]{\otimes} \mathcal{E}_2 & \cdots & \mathcal{E}_{n-1} & \xleftarrow[n-1]{\otimes} \mathcal{E}_n & \xrightarrow[n-1]{\otimes} \mathcal{F}_n & \xrightarrow[n-1]{\otimes} \mathcal{F}_{n-1} & \cdots & \mathcal{F}_2 & \xrightarrow[1]{\otimes} \mathcal{F}_1 & \xrightarrow[0]{\otimes} \mathcal{F}_S \\ & (\mathcal{M}_0, \mu_0) & (\mathcal{M}_1, \mu_1) & & (\mathcal{M}_{n-1}, \mu_{n-1}) & & (\mathcal{L}_{n-1}, \lambda_{n-1}) & & & (\mathcal{L}_1, \lambda_1) & (\mathcal{L}_0, \lambda_0) \end{array} \right)$$

from \mathcal{E}_S to \mathcal{F}_S such that the induced morphism $\mathcal{E}_n \hookrightarrow \mathcal{E}_S \oplus \mathcal{F}_S$ identifies \mathcal{E}_n with the subbundle \mathcal{H}_S . Let i_1 and j_1 be the ranks of $\operatorname{im}(\mathcal{H} \rightarrow \mathcal{E}_{S'})$ and $\operatorname{im}(\mathcal{H} \rightarrow \mathcal{F}_{S'})$ respectively. Observe that $i_1 + j_1 \geq n$. We restrict ourselves to the case, where i_1 and j_1 are both strictly smaller than n . (The cases where one or both of i_1, j_1 are equal to n are proved analogously). Then the sections $\mu_0, \dots, \mu_{i_1-1}$ and $\lambda_{j_1-1}, \dots, \lambda_0$ are invertible and $\mu_{i_1} = \lambda_{j_1} = 0$. From the proof of theorem 9.3 it follows that such a Φ may be given by a tuple $((F_\bullet \mathcal{E}, F_\bullet \mathcal{F}), \varphi, \psi, \Phi')$ where

$$\begin{aligned} F_\bullet \mathcal{E} &= (0 = F_0 \mathcal{E} \subseteq F_1 \mathcal{E} \subseteq F_2 \mathcal{E} \subseteq F_3 \mathcal{E} = \mathcal{E}_S) \\ F_\bullet \mathcal{F} &= (0 = F_0 \mathcal{F} \subseteq F_1 \mathcal{F} \subseteq F_2 \mathcal{F} \subseteq F_3 \mathcal{F} = \mathcal{F}_S) \end{aligned}$$

are the filtrations given by

$$\begin{aligned} F_1 \mathcal{E} &:= \operatorname{im}(\ker(\mathcal{H}_S \rightarrow \mathcal{F}_S) \rightarrow \mathcal{E}_S) \\ F_2 \mathcal{E} &:= \operatorname{im}(\mathcal{H}_S \rightarrow \mathcal{E}_S) \\ F_1 \mathcal{F} &:= \operatorname{im}(\ker(\mathcal{H}_S \rightarrow \mathcal{E}_S) \rightarrow \mathcal{F}_S) \\ F_2 \mathcal{F} &:= \operatorname{im}(\mathcal{H}_S \rightarrow \mathcal{F}_S) \end{aligned}$$

φ is a complete collineation from $F_1 \mathcal{F}/F_0 \mathcal{F} \cong \ker(\mathcal{H}_S \rightarrow \mathcal{E}_S)$ to $F_3 \mathcal{E}/F_2 \mathcal{E} \cong \operatorname{coker}(\mathcal{H}_S \rightarrow \mathcal{E}_S)$, ψ is a complete collineation from $F_1 \mathcal{E}/F_0 \mathcal{E} \cong \ker(\mathcal{H}_S \rightarrow \mathcal{F}_S)$ to $F_3 \mathcal{F}/F_2 \mathcal{F} \cong \operatorname{coker}(\mathcal{H}_S \rightarrow \mathcal{F}_S)$, and Φ' is the isomorphism

$$F_2 \mathcal{E}/F_1 \mathcal{E} \xrightarrow{\sim} \mathcal{H}_S/(\ker(\mathcal{H}_S \rightarrow \mathcal{E}_S) + \ker(\mathcal{H}_S \rightarrow \mathcal{F}_S)) \xrightarrow{\sim} F_2 \mathcal{F}/F_1 \mathcal{F} \quad .$$

We see in particular that the tuple $((F_\bullet \mathcal{E}, F_\bullet \mathcal{F}), \varphi, \psi, \Phi')$ is already determined by the subbundle $\mathcal{H}_S \hookrightarrow \mathcal{E}_S \oplus \mathcal{F}_S$ (i.e. by the morphism $S \rightarrow S'$) and the pair (φ, ψ) . □

REFERENCES

[CP] C. De Concini and C. Procesi: Complete Symmetric Varieties, Invariant theory (Montecatini, 1982), 1–44, Lecture Notes in Math., 996, Springer, Berlin-New York, 1983.

[Da] V.I. Danilov: The geometry of toric varieties, Russ. Math. Surv. 33: 2 (1978), 97-154

[F] G. Faltings: Moduli-stacks for bundles on semistable curves, Math. Ann. 304, 489-515 (1996)

[G] D. Gieseker: A Degeneration of the Moduli Space of Stable Bundles, J. Differential Geometry 19 (1984), 173-206

- [Laf1] L. Lafforgue: Une compactification des champs classifiant les chtoucas de Drinfeld, *J. of the AMS*, Volume 11, No 4, pp 1001-1036 (1998)
- [Laf2] L. Lafforgue: Chtoucas de Drinfeld et Applications. *Proceedings of the ICM, Berlin 1998*, 563-570.
- [Lak1] D. Laksov: Complete Quadrics and Linear Maps, *Proceedings of Symposia in Pure Mathematics*, Volume 46, 371-387 (1987)
- [Lak2] D. Laksov: The geometry of complete linear maps, *Arkiv för Matematik* 26 (1988) no. 2, 231-263.
- [NR] M.S. Narasimhan and T.R. Ramadas: Factorisation of generalised theta functions I, *Invent. Math.* 114 (1993), 565-623
- [NS] D.S. Nagaraj and C.S. Seshadri: Degenerations of the moduli spaces of vector bundles on curves II. (Generalized Gieseker moduli spaces) *Proc. Indian Acad. Sci., Math. Sci.* 109 (1999) no 2, 165-201
- [S1] C.S. Seshadri: Fibrés vectoriels sur les courbes algébriques. *Société mathématique de France, Astérisque* 96 (1980).
- [S2] C.S. Seshadri: Degenerations of the moduli spaces of vector bundles on curves, (revised version of the hand-written notes distributed at the school in algebraic geometry, ICTP, July-August 1999)
- [Sun] X. Sun: Degeneration of Moduli Spaces and Generalized Theta Functions, *math.AG/9907188*, to appear in *Journal of Algebraic Geometry*
- [Tei] M. Teixidor i Bigas: Compactification of moduli spaces of (semi)stable vector bundles: two points of view. Dedicated to the memory of Fernando Serrano. *Collect. Math.* 49 (1998), no 2-3, 527-548.
- [Tha1] M. Thaddeus: Algebraic geometry and the Verlinde formula, D. Phil. thesis, Oxford 1992
- [Tha2] M. Thaddeus: Complete collineations revisited. *math.AG/9808114* (1998).
- [TK] A. Thorup and S. Kleiman: Complete Bilinear Forms, Algebraic geometry (Sundance 1986, A. Holme and R. Speiser, eds.), *LNM* 1311, Springer-Verlag 1988, pp 251-320.
- [V] I. Vainsencher: Complete Collineations and Blowing up Determinantal Ideals, *Math. Ann.* 267, 417-432 (1984)

Ivan Kausz
NWF I - Mathematik
Universität Regensburg
93040 Regensburg
Germany
ivan.kausz@mathematik.uni-regensburg.de

PSEUDOKÄHLER FORMS ON COMPLEX LIE GROUPS

RALPH J. BREMIGAN

Received: July 26, 2000

Communicated by Thomas Peternell

ABSTRACT. Let G be a semisimple complex group with real form $G_{\mathbb{R}}$. We define and study a pseudokähler form that is defined on a neighborhood of the identity in G and is invariant under left and right translation by $G_{\mathbb{R}}$.

2000 Mathematics Subject Classification: Primary: 32M05. Secondary: 22E10, 53C56, 53D20.

Keywords and Phrases: pseudokaehler, symplectic, moment map, Lie group, cotangent bundle

SUMMARY

Let G be a complex semisimple algebraic group with real form $G_{\mathbb{R}}$, the fixed-point subgroup of an antiholomorphic involution $g \mapsto \bar{g}$. The group $G_{\mathbb{R}} \times G_{\mathbb{R}}$ acts on G by the rule $(r_1, r_2)g = r_1 g r_2^{-1}$. In this paper, we give a construction of a $G_{\mathbb{R}} \times G_{\mathbb{R}}$ -invariant pseudokähler form on a neighborhood of $G_{\mathbb{R}}$ in G . We expect this result will find application in several related areas in complex geometry and representation theory. For example, future work of others will show that symplectic reduction (with respect to the imaginary part of the pseudokähler form) relates this open set in G with a neighborhood of a non-compact Riemannian symmetric space in its complexification, as studied by Akhiezer and Gindikin [AG].

As a first guess, one might attempt to construct such a pseudokähler form as follows: given left-invariant vector fields Z, W on G , define the Hermitian product of Z and W to be $\kappa(Z, \bar{W})$, where κ is the Killing form. However, this fails, since the corresponding 2-form (the imaginary part of the Hermitian form) is not closed. Instead, we take the following approach. We construct a pseudokähler form on a complex manifold $M \subset i\mathfrak{g}_{\mathbb{R}} \times G_{\mathbb{R}}$. We then define $M' \subset M$ such that $f|_{M'} : M' \rightarrow G$ is a diffeomorphism onto an open subset of G . Here $f : i\mathfrak{g}_{\mathbb{R}} \times G_{\mathbb{R}} \rightarrow G$ is the map $(iX, r) \mapsto e^{iX} \cdot r$. This allows us to push

down the pseudokähler form on M' to the open set $f(M') \subset G$. The new form turns out to be closely related to the form $Z, W \mapsto \kappa(Z, \overline{W})$.

Our main results are as follows:

Let $G_{\mathbb{R}} \times G_{\mathbb{R}}$ act on $i\mathfrak{g}_{\mathbb{R}} \times G_{\mathbb{R}}$ by the rule $(r_1, r_2)(iX, r) = (i\text{Ad}_{r_1} X, r_1 r r_2^{-1})$; then f is equivariant. Define $M := \{(iX, r) : df \text{ is nonsingular at } (iX, r)\} \subset i\mathfrak{g}_{\mathbb{R}} \times G_{\mathbb{R}}$. This makes M a complex manifold, with complex structure J induced from the complex structure on G . A useful description of M is:

THEOREM 1. $(iX, r) \notin M$ if and only if ad_X has an eigenvalue of $n\pi$ for some nonzero integer n . Equivalently, for $p := e^{iX}$, $(iX, r) \notin M$ exactly when either Ad_p has an eigenvalue of -1 or Ad_p fixes a vector in \mathfrak{g} not fixed by ad_X . (Proof in §2.) \square

Regard $i\mathfrak{g}_{\mathbb{R}} \times G_{\mathbb{R}}$ as the cotangent bundle of $G_{\mathbb{R}}$. As such, there is a canonical real 1-form λ on $i\mathfrak{g}_{\mathbb{R}} \times G_{\mathbb{R}}$ such that $\omega := d\lambda$ is an (exact) nondegenerate symplectic form. On the other hand, let $\phi : i\mathfrak{g}_{\mathbb{R}} \times G_{\mathbb{R}} \rightarrow \mathbb{R}$, $(iX, r) \mapsto \kappa(X, X)$, which is a $G_{\mathbb{R}} \times G_{\mathbb{R}}$ -invariant function. These objects are related:

THEOREM 2. On the complex manifold $M \subset i\mathfrak{g}_{\mathbb{R}} \times G_{\mathbb{R}}$, we have $2\lambda = d^c\phi$. (Proof in §4.) \square

As an immediate corollary, we have:

THEOREM 3. $\omega = d\lambda = \frac{1}{2}dd^c\phi = -i\partial\bar{\partial}\phi$ is a $G_{\mathbb{R}} \times G_{\mathbb{R}}$ -invariant, J -invariant, nondegenerate, exact, real 2-form on M , and

$$\langle A, B \rangle := \omega(JA, B) + i\omega(A, B) \quad (A, B \in T_m M)$$

is a $G_{\mathbb{R}} \times G_{\mathbb{R}}$ -invariant pseudokähler form on M . \square

We seek to compute the pseudokähler form in terms of a reasonable collection of vector fields on M . Let $Z \in \mathfrak{g}$, that is to say, a tangent vector to G at the identity 1. As usual, we may identify Z with a left G -invariant vector field on G . Let \hat{Z} denote the vector field on M obtained by pulling back the left G -invariant vector field Z on G via the map f . These vector fields, which we call *canonical vector fields*, are the ones we shall use throughout for computations. We also need to define several linear transformations on \mathfrak{g} . Let $(iX, r) \in M$ and write $p := e^{iX}$. First, we define $A_p : \mathfrak{g} \rightarrow \mathfrak{g}$, $A_p := \left(\frac{I + \text{Ad}_p}{2}\right)^{-1}$. (This makes sense, by Theorem 1.) We also define $F_{iX} : \mathfrak{g} \rightarrow \mathfrak{g}$ by $F_{iX}(Z) := \left.\frac{d}{ds}\right|_{s=0} \log(pe^{sZ})$. (Here \log denotes a local inverse for \exp , returning a neighborhood of p in G to a neighborhood of iX in \mathfrak{g} .) Finally, define $E_{iX} := F_{iX} \circ A_p \circ \text{Ad}_p$. Our result is:

THEOREM 4. For $Z, W \in \mathfrak{g}$ and $(iX, r) \in M$, we have that $\left\langle \hat{Z}, \widehat{W} \right\rangle_{(iX, r)} = \kappa(E_{i\text{Ad}_r^{-1} X} Z, \overline{W})$. (Proof in §5.) \square

Theorem 4 is useful since E_{iX} is easy to understand: if ad_X is diagonalizable, then E_{iX} is also diagonalizable, has the same eigenspaces as ad_X , and

its eigenvalues can be expressed in terms of the corresponding eigenvalues of ad_X . In particular, if X lies in a Cartan subalgebra $\mathfrak{t}_{\mathbb{R}}$ of $\mathfrak{g}_{\mathbb{R}}$, then one has a simple expression for $\langle \cdot, \cdot \rangle$ at $(iX, 1)$ when expressed using canonical vector fields corresponding to elements of \mathfrak{g} that are root vectors or vectors in \mathfrak{t} . We refer the reader to §6 for the precise statement. Additionally,

THEOREM 5. *The signature of the pseudokähler form is constant on M , and is equal to the signature of the Hermitian form $Z, W \mapsto \kappa(Z, \bar{W})$ on \mathfrak{g} . (Proof in §6.) \square*

Trivially, if $M' \subset M$ is open and $G_{\mathbb{R}} \times G_{\mathbb{R}}$ -stable, and if $f|_{M'}$ is injective, then the pseudokähler form on M' pushes down to a $G_{\mathbb{R}} \times G_{\mathbb{R}}$ -invariant pseudokähler form on $f(M')$, which is open in G . We produce such a set M' :

THEOREM 6. *Let $\psi : G \rightarrow GL(V)$, $\mathfrak{g} \rightarrow gl(V)$ be a finite-dimensional representation that is defined over \mathbb{R} and is faithful modulo the center of G (e.g. the adjoint representation). Define $M' \subset i\mathfrak{g}_{\mathbb{R}} \times G_{\mathbb{R}}$, where $(iX, r) \in M'$ if and only if for each eigenvalue λ of $\psi(X)$, $|\text{Re } \lambda| < \pi/2$. Then*

- (1) $M' \subset M$,
- (2) M' is $G_{\mathbb{R}} \times G_{\mathbb{R}}$ -stable,
- (3) M' is open in $i\mathfrak{g}_{\mathbb{R}} \times G_{\mathbb{R}}$,
- (4) $f|_{M'}$ is injective. (Proof in §8.) \square

In some applications, it is more convenient to replace the above canonical vector fields with tangent vectors that are either tangent (“orbital vectors”) or transverse (“vertical vectors”) to the $G_{\mathbb{R}} \times G_{\mathbb{R}}$ -orbits. We set up the notation and compute the pseudokähler form using these vectors (§7). The imaginary part of the pseudokähler form is particularly easy, and from it, one easily computes the moment map:

THEOREM 7. *Relative to the symplectic form ω , the moment map $\mu : i\mathfrak{g}_{\mathbb{R}} \times G_{\mathbb{R}} \rightarrow \mathfrak{g}_{\mathbb{R}}^* \times \mathfrak{g}_{\mathbb{R}}^* \simeq \mathfrak{g}_{\mathbb{R}} \times \mathfrak{g}_{\mathbb{R}}$ is given by $(iX, r) \mapsto (X, -\text{Ad}_r^{-1}X)$. The moment map separates $G_{\mathbb{R}} \times G_{\mathbb{R}}$ -orbits. We have $\|\mu\|^2 = 2\phi$. \square*

The present paper extends recent results of Gregor Fels. In [F], pseudokähler forms are defined on certain complex domains which turn out to be subsets of M . In §7, we verify that the restriction of $\langle \cdot, \cdot \rangle$ to these domains coincides with Fels’ definition. That paper uses orbital and vertical vector fields, and includes discussions of the moment map and CR-structures. I am grateful to G. F. for sharing a copy of his preprint with me. I also thank Alan Huckleberry for suggesting this problem to me and for helpful conversations.

§1. THE GROUP ACTION

Let G be a connected complex semisimple algebraic group, endowed with a complex conjugation $g \mapsto \bar{g}$, defining a real form $G_{\mathbb{R}} \subset G$ (the fixed point subgroup of the complex conjugation). The real group $G_{\mathbb{R}} \times G_{\mathbb{R}}$ acts on G by the rule $(r_1, r_2)g = r_1gr_2^{-1}$. Let $\mathfrak{g} = T_e(G)$ denote the Lie algebra of G , with

Killing form κ . Given $Y \in \mathfrak{g}$, the left- and right-invariant vector fields on G generated by Y are denoted $g \mapsto dl_g Y$ and $g \mapsto dr_g Y$.

We can identify the cotangent bundle $T^*(G_{\mathbb{R}})$ with $i\mathfrak{g}_{\mathbb{R}} \times G_{\mathbb{R}}$; namely, from $X \in \mathfrak{g}_{\mathbb{R}}$ and $k \in G_{\mathbb{R}}$, we obtain the 1-form at k that sends $dr_k Y$ to $\kappa(X, Y)$, where $Y \in \mathfrak{g}_{\mathbb{R}}$. The action of $G_{\mathbb{R}} \times G_{\mathbb{R}}$ on $G_{\mathbb{R}}$ (by left/right translation) induces an action on $T^*(G_{\mathbb{R}})$, which in the above identification gives the following action of $G_{\mathbb{R}} \times G_{\mathbb{R}}$ on $i\mathfrak{g}_{\mathbb{R}} \times G_{\mathbb{R}}$:

$$(r_1, r_2)(iX, r) = (\text{Ad}_{r_1}(iX), r_1 r r_2^{-1}).$$

With this action, the map $f : i\mathfrak{g}_{\mathbb{R}} \times G_{\mathbb{R}} \rightarrow G$, $(iX, r) \mapsto e^{iX} r$ is equivariant.

We shall often be particularly interested in the case when X is semisimple, and we now set up some notation. If X is semisimple, then it is contained in $\mathfrak{t}_{\mathbb{R}}$, where \mathfrak{t} is a (complex) Cartan subalgebra of \mathfrak{g} that is stable under complex conjugation. Also $p := e^{ix} \in T$, where T is the maximal (complex) \mathbb{R} -torus of G with $\text{Lie}(T) = \mathfrak{t}$. We have a root system $\Phi(T, G)$ consisting of characters $\alpha : T \rightarrow \mathbb{C}^*$, with differentials $d\alpha : \mathfrak{t} \rightarrow \mathbb{C}$. (By abuse of notation, we write $-\alpha$ for the inverse of α .) Roots are real, imaginary, or complex according to whether $\bar{\alpha} = \alpha$, $-\alpha$, or neither. Imaginary roots arise in two ways, according to whether the set of real points of the corresponding root $sl(2)$ is isomorphic to $sl(2, \mathbb{R})$ or $su(2)$, and are respectively “noncompact imaginary” or “compact imaginary” roots. We have that $d\alpha(iX) \in i\mathbb{R}$ (resp. \mathbb{R}) if α is real (resp. imaginary) and hence $\alpha(p) = e^{d\alpha(iX)} \in U(1)$ (resp. $\mathbb{R}^{>0}$).

We recall some related facts (see [BF]). Let $Z(G) = \{g \in G : \bar{g} = g^{-1}\}$. It is a topologically closed, smooth, $\text{Int } G_{\mathbb{R}}$ -stable submanifold of G of real dimension equal to the complex dimension of G . The subset $B(G) := \{h \cdot \bar{h}^{-1} : h \in G\} \subset Z(G)$ coincides with the connected component of $Z(G)$ containing 1. Since $e^{iX} = e^{iX/2} \cdot \overline{e^{iX/2}}^{-1}$, we have $\exp(i\mathfrak{g}_{\mathbb{R}}) \subset B(G)$.

§2. THE COMPLEX MANIFOLD M AND CANONICAL VECTOR FIELDS

In this section, we define the “canonical vector fields,” which are global vector fields on a dense open subset $M \subset i\mathfrak{g}_{\mathbb{R}} \times G_{\mathbb{R}}$ that are associated to elements of \mathfrak{g} . We define and provide a characterization of M (2.1). Given a point $(iX, r) \in M$ and $Z \in \mathfrak{g}$, we produce a curve through (iX, r) in M whose tangent vector at (iX, r) is the canonical tangent vector associated to Z (2.6).

We would like to define global vector fields on $i\mathfrak{g}_{\mathbb{R}} \times G_{\mathbb{R}}$ by pulling back the left invariant vector fields on G via the map f ; that is, given $Z \in \mathfrak{g}$, we would like to define a vector field $\hat{Z} = Z^\wedge$ on $i\mathfrak{g}_{\mathbb{R}} \times G_{\mathbb{R}}$ by the rule $\hat{Z}_{(iX, r)} = (df)^{-1}(dl_{f(iX, r)} Z)$. This works precisely at the points where df is an isomorphism. We define $M = \{(iX, r) : \text{ad}_X \text{ has no eigenvalue of } \pi n \text{ for any nonzero integer } n\} \subset i\mathfrak{g}_{\mathbb{R}} \times G_{\mathbb{R}}$. Letting $p = e^{iX}$, we see that (iX, r) fails to be in M exactly when either Ad_p has an eigenvalue of -1 , or Ad_p fixes a point in \mathfrak{g} not fixed by ad_X . Below we prove:

THEOREM 2.1. *The differential of f is an isomorphism at (iX, r) precisely when $(iX, r) \in M$. \square*

Thus an element $Z \in \mathfrak{g}$ yields a globally-defined nonvanishing vector field \widehat{Z} on M , which we call the *canonical vector field associated to Z* . We see, by taking a basis of \mathfrak{g} , that the tangent bundle of M is trivial. If we denote the complex structure on M by J , we have that $J(\widehat{Z}) = (iZ)^\wedge$, where i is the complex structure on the vector space \mathfrak{g} . The action of $G_{\mathbb{R}} \times G_{\mathbb{R}}$ on M induces an action on vector fields, and ${}^{(r_1, r_2)}(\widehat{Z}) = (\text{Ad}_{r_2} Z)^\wedge$.

For df to be nonsingular at (iX, r) , we need the exponential map $\exp : i\mathfrak{g}_{\mathbb{R}} \rightarrow B(G)$ to be nonsingular at iX , and we need the multiplication map $B(G) \times G_{\mathbb{R}} \rightarrow G$ to be nonsingular at (e^{iX}, r) . Thus 2.1 follows from 2.2 and 2.3 below.

PROPOSITION 2.2. (See [V].) *Given $\exp : \mathfrak{g} \rightarrow G$ and $Y \in \mathfrak{g}$, then the differential $d\exp : T_Y(\mathfrak{g}) \rightarrow T_{e^Y}(G)$ is given by*

$$d\exp : W \mapsto \left. \frac{d}{ds} \right|_{s=0} e^{Y+sW} = dl_{(e^Y)} \sum_{n=0}^{\infty} \frac{(-\text{ad}_Y)^n}{(n+1)!} W$$

and is an isomorphism exactly when ad_Y has no eigenvalue of $2\pi in$, $n \in \mathbb{Z} \setminus \{0\}$. \square

(In particular, if $Y \in \mathfrak{g}$ has no eigenvalue of $2\pi in$ (n a nonzero integer), then there is a well-defined map $\log = \log_Y$ from a neighborhood of e^Y in G to a neighborhood of Y in \mathfrak{g} . If $Y = iX$ ($X \in \mathfrak{g}_{\mathbb{R}}$), then in addition, \log maps a neighborhood of e^{iX} in $Z(G)$ to a neighborhood of iX in $i\mathfrak{g}_{\mathbb{R}}$.)

PROPOSITION 2.3. *The differential of the multiplication map $Z(G) \times G_{\mathbb{R}} \rightarrow G$ at (p, r) is an isomorphism if and only if Ad_p has no eigenvalue of -1 .*

Before proving 2.3, we need to define an important linear operator on \mathfrak{g} . Let $X \in \mathfrak{g}_{\mathbb{R}}$ and let $p = e^{iX}$. Assume that Ad_p has no eigenvalue of -1 . We define $A_p : \mathfrak{g} \rightarrow \mathfrak{g}$ by $A_p = \left(\frac{I + \text{Ad}_p}{2}\right)^{-1}$. We will often use the following properties of A_p :

LEMMA 2.4.

- (1) $\overline{A_p} = \text{Ad}_p \circ A_p = 2I - A_p$.
- (2) $\kappa(Z, \text{Ad}_p W) = \kappa(\text{Ad}_p^{-1} Z, W)$.
- (3) $\kappa(Z, A_p W) = \kappa(\text{Ad}_p \circ A_p Z, W)$.
- (4) $[X, DW] = D[X, W]$, where $D = \text{Ad}_p$ or A_p .
- (5) $[Z, A_p W] - [\text{Ad}_p \circ A_p Z, W] = \frac{1}{2}(I - \text{Ad}_p)[A_p Z, A_p W]$.
- (6) $\kappa(X, [Z, A_p W]) = \kappa(X, [\text{Ad}_p \circ A_p Z, W])$.
- (7) $A_p W = W$ if $[X, W] = 0$, and more generally, $A_p W = \frac{2}{1+e^\mu}$ if $[iX, W] = \mu W$.

Proof. For (1), we compute that $\overline{A_p} = \left(\frac{I + \text{Ad}_p^{-1}}{2}\right)^{-1} = \text{Ad}_p \circ \left(\frac{\text{Ad}_p + I}{2}\right)^{-1} = \text{Ad}_p \circ A_p$. Moreover, $A_p + \text{Ad}_p \circ A_p = A_p \circ (I + \text{Ad}_p) = 2I$. (2) follows from

the Ad-invariance of κ . To prove (3), let $Z' = A_p Z$ and $W' = A_p W$. Then the left side of (3) is $\kappa(\frac{I+\text{Ad}_p}{2} Z', W') = \frac{1}{2}\kappa(Z', W') + \frac{1}{2}\kappa(\text{Ad}_p Z', W')$, whereas the right side is $\kappa(\text{Ad}_p Z', \frac{I+\text{Ad}_p}{2} W') = \frac{1}{2}\kappa(\text{Ad}_p Z', \text{Ad}_p W') + \frac{1}{2}\kappa(\text{Ad}_p Z', W')$. The proofs of (4), (5), and (6) are similar, using also that A_p and Ad_p fix X . (7) is immediate from the definition of A_p . \square

LEMMA 2.5. *If $p \in Z(G)$, then $T_p(Z(G)) = \{dl_p Z : Z \in T_e(G) \text{ and } \bar{Z} = -\text{Ad}_p(Z)\}$, and for such Z , $pe^{tZ} \in Z(G)$ for all $t \in \mathbb{R}$.*

Proof. Since $Z(G)$ is smooth, any tangent vector at p can be written as $dl_p Z$ for some $Z \in \mathfrak{g}$. If $\bar{Z} = -\text{Ad}_p Z$ then the curve pe^{tZ} is contained in $Z(G)$ since $\overline{pe^{tZ}} = p^{-1}e^{t\bar{Z}}$ and $(pe^{tZ})^{-1} = e^{-tZ}p^{-1} = p^{-1}e^{-t\text{Ad}_p Z} = p^{-1}e^{t\bar{Z}}$. Hence all such Z give tangent vectors in $Z(G)$. Note that since $\bar{p} = p^{-1}$, $Z \mapsto \overline{\text{Ad}_p Z}$ gives a complex conjugation on the vector space \mathfrak{g} ; the choice of Z above amounts to the pure imaginary elements of \mathfrak{g} for this real structure. The lemma follows since $\dim_{\mathbb{R}}(Z(G)) = \dim_{\mathbb{C}} \mathfrak{g}$. \square

Proof of 2.3. Tangent vectors at pr which are in the image of the differential of the multiplication map at (p, r) are exactly those of the form $\frac{d}{dt}|_{t=0} pe^{tZ} e^{tY} r = \frac{d}{dt}|_{t=0} pe^{t(Z+Y)} r$, where $\bar{Z} = -\text{Ad}_p Z$ and $\bar{Y} = Y$. Hence (Z, Y) is in the kernel of the differential exactly when $Z = -Y$, which is possible for Z exactly when Z is real, meaning $\text{Ad}_p Z = -Z$. \square

Let $(iX, r) \in M$ and $Z \in \mathfrak{g}$. Since $t \mapsto e^{iX} r e^{tZ}$ gives an integral curve (starting at $e^{iX} r$) for the left invariant vector field associated to Z , we can obtain (for t small) an integral curve at (iX, r) for \widehat{Z} , by locally inverting f . The resulting curve δ is described below. Unfortunately this curve is unwieldy for computations. Instead, we produce a simpler curve γ in $i\mathfrak{g}_{\mathbb{R}} \times G_{\mathbb{R}}$ which has tangent vector \widehat{Z} at (iX, r) but not at other points on the curve. (This will be sufficient for applications.)

PROPOSITION 2.6. *Let $(iX, r) \in M$, with $p = e^{iX}$, and let $Z \in \mathfrak{g}$. Define the following curves in M :*

$$\begin{aligned} \gamma_{iX,r,Z} : t &\mapsto \left(\log \left(pe^{tA_p \circ \text{Ad}_r i\text{Im } Z} \right), e^{t(\text{Ad}_r Z - A_p \circ \text{Ad}_r i\text{Im } Z)} \cdot r \right) \\ \delta_{iX,r,Z} : t &\mapsto \left(\frac{1}{2} \log_{2iX} (pre^{tZ} e^{-t\bar{Z}} r^{-1} p), p(t)^{-1} pre^{tZ} \right) \\ p(t) &:= \exp \left(\frac{1}{2} \log_{2iX} (pre^{tZ} e^{-t\bar{Z}} r^{-1} p) \right) \end{aligned}$$

Then $\frac{d}{dt}|_{t=0} \gamma = \widehat{Z}_{(iX,r)}$, and δ is an integral curve for \widehat{Z} starting at (iX, r) .

Proof. (a) Both curves have a value of (iX, r) at $t = 0$. (b) We must verify that the curves actually lie in $i\mathfrak{g}_{\mathbb{R}} \times G_{\mathbb{R}}$. For γ , one can use 2.5 to show that $pe^{tA_p \circ \text{Ad}_r i\text{Im } Z} \in Z(G)$, and using 2.4(1), it is easy to verify that $\text{Ad}_r Z - A_p \circ \text{Ad}_r i\text{Im } Z \in \mathfrak{g}_{\mathbb{R}}$. For δ , one has that $pre^{tZ} e^{-t\bar{Z}} r^{-1} p \in Z(G)$ since its

complex conjugate equals its inverse. The fact that $p(t)^{-1}pre^{tZ} \in G_{\mathbb{R}}$ turns out to be equivalent to $p(t)^2 = pre^{tZ}e^{-t\bar{Z}}r^{-1}p$, which is true by definition. (c) Proving that the curves have the correct derivatives follows from pushing them forward via f . We have that $f(\gamma(t)) = pe^{tA_p \circ \text{Ad}_r \circ i\text{Im } Z} e^{t(\text{Ad}_r - A_p \circ \text{Ad}_r \circ i\text{Im } Z)_r}$, whose derivative at $t = 0$ is $dl_p \circ dr_r \circ \text{Ad}_r Z = dl_{pr}Z$, as required. Note that at other values of t , tangent vectors for this curve do not coincide with the left invariant vector field on G ! However, we do have $f(\delta(t)) = pre^{tZ}$, as required. \square

§3. THE DIFFERENTIAL OF THE LOGARITHM MAP

Throughout this section, let $(iX, r) \in M$ and let $p = e^{iX}$. We define:

$$F_{iX} : \mathfrak{g} \rightarrow \mathfrak{g} \quad F_{iX}(Z) = \left. \frac{d}{ds} \right|_{s=0} \log_{iX}(pe^{sZ})$$

This section is devoted to listing properties of this map. By definition $F_{iX} = d(\log_{iX} \circ l_p)$, with the differential taken at the identity. Near the identity element of G , the map $l_{p^{-1}} \circ \exp \circ \log_{iX} \circ l_p$ is (defined and) the identity function, so after taking differentials at the identity, we have

$$I = (dl_p)^{-1} \circ d \exp \circ d(\log_{iX} \circ l_p) = \sum_{n=0}^{\infty} \frac{(-\text{ad}_{iX})^n}{(n+1)!} \circ F_{iX} \quad \text{by 2.2.}$$

LEMMA 3.1. $F_{iX} = \lim_{c \rightarrow 0} (icI - \text{ad}_{iX}) \circ (e^{icI - \text{ad}_{iX}} - I)^{-1}$.

Proof.

Let $T = -\text{ad}_{iX}$ and $\lambda \in \mathbb{C}$. We must prove that

$$\sum_{n=0}^{\infty} \frac{T^n}{(n+1)!} \circ \lim_{c \rightarrow 0} (icI - \text{ad}_{iX}) \circ (e^{icI - \text{ad}_{iX}} - I)^{-1} = I \in GL(\mathfrak{g}).$$

We compute that

$$\begin{aligned} & \sum_{n=0}^{\infty} \frac{T^n}{(n+1)!} \circ \lim_{c \rightarrow 0} (icI - \text{ad}_{iX}) \circ (e^{icI - \text{ad}_{iX}} - I)^{-1} \\ &= \left(\sum_{n=0}^{\infty} \frac{T^n}{(n+1)!} \right) \circ \lim_{\lambda \rightarrow 0} (\lambda I + T) \circ (e^{\lambda I + T} - I)^{-1} \\ &= \lim_{\lambda \rightarrow 0} \left(\sum_{n=0}^{\infty} \frac{(\lambda I + T)^n}{(n+1)!} \right) \circ (\lambda I + T) \circ (e^{\lambda I + T} - I)^{-1} \\ &= \lim_{\lambda \rightarrow 0} \sum_{n=0}^{\infty} \frac{(\lambda I + T)^n}{(n+1)!} \circ (\lambda I + T) \circ (e^{\lambda I + T} - I)^{-1} \end{aligned}$$

and if $S := \lambda I + T$, then $\sum_{n=0}^{\infty} \frac{S^n}{(n+1)!} \circ S \circ (e^S - I)^{-1} = \sum_{n=1}^{\infty} \frac{S^n}{n!} \circ (e^S - I)^{-1} = (e^S - I) \circ (e^S - I)^{-1} = I$. \square

LEMMA 3.2.

- (1) $F_{iX}(W) = W$ if $[X, W] = 0$, and $F_{iX}(W) = \frac{-\mu e^\mu}{1-e^\mu} W$ if $[iX, W] = \mu W$, $\mu \neq 0$.
- (2) $\overline{F}_{iX} = \text{Ad}_p^{-1} \circ F_{iX} = F_{-iX}$.
- (3) $\kappa(Z, F_{iX}W) = \kappa(F_{-iX}Z, W)$ for all $Z, W \in \mathfrak{g}$.
- (4) $\kappa(X, F_{iX}(W)) = \kappa(X, W)$ for all $W \in \mathfrak{g}$.
- (5) $\text{ad}_{iX} = F_{iX} \circ (I - \text{Ad}_p^{-1})$.

Proof. (1,2) are easy. By substitution, (3) is equivalent to $\kappa(Z, d(l_{p^{-1}} \circ \exp)_{iX}W) = \kappa(d(l_p \circ \exp)_{-iX}Z, W)$. By 2.2, $\kappa(Z, d(l_{p^{-1}} \circ \exp)_{iX}W) = \kappa\left(Z, \sum \frac{(-\text{ad}_{iX})^n}{(n+1)!} W\right)$, which equals $\kappa\left(\sum \frac{(\text{ad}_{iX})^n}{(n+1)!} Z, W\right) = \kappa(d(l_p \circ \exp)_{-iX}Z, W)$ by the associativity of the Killing form. Then (4) follows from (1) and (3). For (5), we have $F_{iX} \circ (I - \text{Ad}_p^{-1}) = F_{iX} \circ \left(-\sum_{n=0}^{\infty} \frac{(-\text{ad}_{iX})^n}{n!} + I\right) = F_{iX} \circ \left(-\sum_{n=0}^{\infty} \frac{(-\text{ad}_{iX})^{n+1}}{(n+1)!}\right) = F_{iX} \circ \left(\sum_{n=1}^{\infty} \frac{(-\text{ad}_{iX})^n}{(n+1)!}\right) \circ \text{ad}_{iX} = I \circ \text{ad}_{iX}$. \square

§4. THE LIOUVILLE FORM ON M AND ITS EXTERIOR DERIVATIVE

We recall that the cotangent bundle to any real manifold possesses a canonical 1-form λ and that $\omega := d\lambda$ is a nondegenerate exact symplectic form (see [A], [CG]). We have identified $T^*(G_{\mathbb{R}})$ with $i\mathfrak{g}_{\mathbb{R}} \times G_{\mathbb{R}}$. Given a curve $(iX(t), r(t))$, then one can check that $\lambda\left(\frac{d}{dt}\Big|_{t=0}(iX(t), r(t))\right) = \kappa(X(0), \frac{d}{dt}\Big|_{t=0}r(t)r(0)^{-1})$. It is easy to see that λ is $G_{\mathbb{R}} \times G_{\mathbb{R}}$ -invariant. We wish to obtain a formula for $\lambda(\widehat{Z})$; this conveniently expresses the restriction of λ to M . By 2.6, we have that $\lambda(\widehat{Z})_{(iX,r)} = \kappa(X, \frac{d}{dt}\Big|_{t=0}e^{t(\text{Ad}_r Z - A_p \circ \text{Ad}_r i\text{Im} Z)}) = \kappa(X, \text{Ad}_r Z - A_p \circ \text{Ad}_r i\text{Im} Z)$, where $p = e^{iX}$. This can be sharpened:

PROPOSITION 4.1. *For all $(iX, r) \in M$, $\lambda(\widehat{Z})_{(iX,r)} = \kappa(X, \text{Ad}_r \text{Re} Z)$.*

Proof. We must show that $\kappa(X, \text{Ad}_r i\text{Im} Z) = \kappa(X, A_p \circ \text{Ad}_r i\text{Im} Z)$. This follows from 2.4(3), since $\text{Ad}_p \circ A_p(X) = X$. \square

On M , we have a complex structure J . Even prior to the explicit computation of $d\lambda$, we have the following important observation:

THEOREM 4.2. *As a differential form on M , the 2-form $\omega := d\lambda$ is J -invariant.* \square

This is a consequence of 4.4, for which we recall the customary notation. On any complex manifold, the exterior derivative is written as the sum $d = \partial + \bar{\partial}$. Let $d^c = i(\partial - \bar{\partial})$. From $d^2 = 0$, we know that $\partial\bar{\partial} = -\bar{\partial}\partial$, and hence $dd^c = 2i\bar{\partial}\partial = -d^c d$. One can show (e.g. using local coordinates) that if ϕ is a smooth function and X a vector field on M , then $d^c\phi(X) = d\phi(JX)$; by the derivation property, if μ is a 1-form, then $d^c\mu(X_1, X_2) = JX_1(\mu(X_2)) - JX_2(\mu(X_1)) - \mu(J[X_1, X_2])$.

We confirm that $dd^c(\phi)$ is J -invariant: by the product rule we have

$$\begin{aligned} dd^c\phi(X_1, X_2) &= X_1(d^c\phi(X_2)) - X_2(d^c\phi(X_1)) - d^c\phi([X_1, X_2]) \\ &= X_1(d\phi(JX_2)) - X_2(d\phi(JX_1)) - d\phi(J[X_1, X_2]), \end{aligned}$$

and hence

$$\begin{aligned} dd^c\phi(JX_1, JX_2) &= JX_1(d\phi(-X_2)) - JX_2(d\phi(-X_1)) - d\phi(J[JX_1, JX_2]) \\ &= -JX_1(d\phi(X_2)) + JX_2(d\phi(X_1)) + d\phi(J[X_1, X_2]) \\ &= -d^c d\phi(X_1, X_2) = dd^c\phi(X_1, X_2). \end{aligned}$$

DEFINITION/THEOREM 4.3. *Let $\phi : M \rightarrow \mathbb{R}$ be the $G_{\mathbb{R}} \times G_{\mathbb{R}}$ -invariant function $\phi(iX, r) = \kappa(X, X)$. Then $2\lambda = d^c(\phi)$.*

Proof. By definition,

$$\begin{aligned} d^c\phi(\widehat{Z})_{(iX,r)} &\stackrel{\text{def of } d^c}{=} (J\widehat{Z}(\phi))_{(iX,r)} \stackrel{2.6}{=} \left. \frac{d}{dt} \right|_{t=0} (\phi(\gamma_{iX,r,jZ}(t))) \\ &\stackrel{2.6, \text{def of } \phi}{=} 2\kappa \left(-i \left. \frac{d}{dt} \right|_{t=0} \log(pe^{tA_p \circ \text{Ad}_r \circ i\text{Im } iZ}), X \right) \\ &= 2\kappa(F_{iX} \circ A_p \circ \text{Ad}_r \text{Re } Z, X) \\ &\stackrel{2.4(3), 3.2(4)}{=} 2\kappa(\text{Ad}_r \text{Re } Z, X) \stackrel{4.1}{=} 2\lambda(\widehat{Z})_{(iX,r)}. \quad \square \end{aligned}$$

COROLLARY 4.4. $\omega = d\lambda = \frac{1}{2}dd^c(\phi) = -i\partial\bar{\partial}(\phi)$. \square

§5. COMPUTATION OF THE PSEUDOKÄHLER FORM

Let $\omega = d\lambda$, a 2-form on $i\mathfrak{g}_{\mathbb{R}} \times G_{\mathbb{R}} \supset M$. Here we compute the restriction of ω to M , using the vector fields \widehat{Z} (which are only defined on M). We use the formula $\omega(\widehat{Z}, \widehat{W}) = \widehat{Z}(\lambda(\widehat{W})) - \widehat{W}(\lambda(\widehat{Z})) - \lambda([\widehat{Z}, \widehat{W}])$.

We will require another linear operator on \mathfrak{g} . For $(iX, r) \in M$ and $p := e^{iX}$, let

$$E_{iX} = F_{iX} \circ \text{Ad}_p \circ A_p = d(\log \circ l_p) \circ \text{Ad}_p \circ A_p.$$

(Note that the three factors commute.) We collect some properties of E_{iX} and $F_{iX} \circ A_p$:

LEMMA 5.1.

- (1) $\overline{E}_{iX} = F_{iX} \circ \text{Ad}_p^{-1} \circ A_p$.
- (2) For all $Z, W \in \mathfrak{g}$, $\kappa(E_{iX}Z, W) = \kappa(Z, \overline{E}_{iX}W)$.
- (3) $i\text{Im } E_{iX} = \text{ad}_{iX}$.
- (4) If $[X, W] = 0$ then $E_{iX}W = W$.
- (5) $\overline{F}_{iX} \circ A_p = F_{iX} \circ A_p$ and for all $Z, W \in \mathfrak{g}$, we have $\kappa(F_{iX} \circ A_p Z, W) = \kappa(Z, F_{iX} \circ A_p W)$.

Proof. $\overline{E}_{iX} = \overline{F_{iX} \circ (\text{Ad}_p \circ A_p)} \stackrel{2.4(1), 3.2(2)}{=} (F_{iX} \circ \text{Ad}_p^{-1}) \circ A_p$, proving (1). Then (2) follows from (1), 2.4(1,2), and 3.2(2,3). To prove (3), we note $2i\text{Im } E_{iX} = E_{iX} - \overline{E}_{iX} \stackrel{5.1(1)}{=} F_{iX} \circ A_p \circ \text{Ad}_p - F_{iX} \circ A_p \circ \text{Ad}_p^{-1} = F_{iX} \circ \text{Ad}_p^{-1} \circ A_p \circ (\text{Ad}_p^2 - I) = 2F_{iX} \circ (\text{Ad}_p - I) \circ \text{Ad}_p^{-1} \circ A_p \circ \left(\frac{\text{Ad}_p + I}{2}\right) = 2F_{iX} \circ (I - \text{Ad}_p)^{-1} \stackrel{3.2(5)}{=} 2\text{ad}_{iX}$. Finally, (4) follows from 2.4(7) and 3.2(1), and (5) is similar to (1) and (2). \square

We return to the computation of $d\lambda$. First,

$$\begin{aligned} & \widehat{Z}(\lambda\widehat{W})_{(iX,r)} \\ & \stackrel{4.1}{=} \widehat{Z}(\kappa(X, \text{Ad}_r \text{Re } W)) \\ & \stackrel{2.6}{=} \left. \frac{d}{dt} \right|_{t=0} \kappa(-i \log p e^{tA_p \circ \text{Ad}_r i\text{Im } Z}, \text{Ad}_{e^{t(\text{Ad}_r Z - A_p \circ \text{Ad}_r i\text{Im } Z)}} \circ \text{Ad}_r \text{Re } W) \\ & = \kappa(-iF_{iX} \circ A_p \circ \text{Ad}_r i\text{Im } Z, \text{Ad}_r \text{Re } W) \\ & \quad + \kappa(X, \text{ad}_{\text{Ad}_r Z - A_p \circ \text{Ad}_r i\text{Im } Z} \circ \text{Ad}_r \text{Re } W) \\ & = \kappa(F_{iX} \circ A_p \circ \text{Ad}_r \text{Im } Z, \text{Ad}_r \text{Re } W) \\ & \quad - i\kappa(\text{ad}_{iX}(\text{Ad}_r Z - A_p \circ \text{Ad}_r i\text{Im } Z), \text{Ad}_r \text{Re } W) \\ & = \kappa(F_{iX} \circ A_p \circ \text{Ad}_r \text{Im } Z, \text{Ad}_r \text{Re } W) \\ & \quad - i\kappa(F_{iX} \circ (I - \text{Ad}_p^{-1})(\text{Ad}_r Z - A_p \circ \text{Ad}_r i\text{Im } Z), \text{Ad}_r \text{Re } W) \text{ by 3.2(5)} \\ & = \kappa(F_{iX} \circ A_p \circ \text{Ad}_p^{-1} \circ \text{Ad}_r \text{Im } Z, \text{Ad}_r \text{Re } W) \\ & \quad - i\kappa(F_{iX} \circ (I - \text{Ad}_p^{-1}) \circ \text{Ad}_r Z, \text{Ad}_r \text{Re } W) \\ & = \frac{-i}{4} \kappa(F_{iX} \circ A_p \circ \text{Ad}_p^{-1} \circ \text{Ad}_r(Z - \overline{Z}), \text{Ad}_r(W + \overline{W})) \\ & \quad + \frac{-i}{4} \kappa(F_{iX} \circ (I - \text{Ad}_p^{-1}) \circ \text{Ad}_r 2Z, \text{Ad}_k(W + \overline{W})). \end{aligned}$$

Similarly, we have

$$\begin{aligned} -\widehat{W}(\lambda\widehat{Z})_{(iX,r)} & = \frac{i}{4} \kappa(\text{Ad}_r(Z + \overline{Z}), F_{iX} \circ A_p \circ \text{Ad}_p^{-1} \circ \text{Ad}_r(W - \overline{W})) \\ & \quad + \frac{i}{4} \kappa(\text{Ad}_r(Z + \overline{Z}), F_{iX} \circ (I - \text{Ad}_p^{-1}) \circ \text{Ad}_r 2W) \\ & = \frac{i}{4} \kappa(F_{iX} \circ A_p \circ \text{Ad}_p \circ \text{Ad}_r(Z + \overline{Z}), \text{Ad}_r(W - \overline{W})) \\ & \quad + \frac{i}{4} \kappa(F_{iX} \circ \text{Ad}_p^{-1} \circ (I - \text{Ad}_p) \circ \text{Ad}_r(Z + \overline{Z}), \text{Ad}_r 2W) \\ & \quad \text{by 5.1(5), 3.2(2,3)}. \end{aligned}$$

Finally,

$$\begin{aligned}
 -\lambda[\widehat{Z}, \widehat{W}] &= -\lambda([Z, W]^\wedge) = -\kappa(X, \text{Ad}_r \text{Re}[Z, W]) \\
 &= \frac{i}{2} \kappa(iX, \text{Ad}_r[Z, W]) + \frac{i}{2} \kappa(iX, \text{Ad}_r[\overline{Z}, \overline{W}]) \\
 &= \frac{i}{2} \kappa(F_{iX} \circ (I - \text{Ad}_p^{-1}) \circ \text{Ad}_r Z, \text{Ad}_r W) \\
 &\quad + \frac{i}{2} \kappa(F_{iX} \circ (I - \text{Ad}_p^{-1}) \circ \text{Ad}_r \overline{Z}, \text{Ad}_r \overline{W}).
 \end{aligned}$$

Summing the terms and using 2.4(1), we find

$$\begin{aligned}
 \omega(\widehat{Z}, \widehat{W}) &= \frac{-i}{2} \kappa(F_{iX} \circ A_p \circ \text{Ad}_p \circ \text{Ad}_r Z, \text{Ad}_r \overline{W}) \\
 &\quad + \frac{i}{2} \kappa(F_{iX} \circ A_p \circ \text{Ad}_p^{-1} \circ \text{Ad}_r \overline{Z}, \text{Ad}_r W) \\
 &= \frac{-i}{2} (\kappa(E_{iX} \circ \text{Ad}_r Z, \text{Ad}_r \overline{W}) - \kappa(E_{iX} \circ \text{Ad}_p^{-2} \circ \text{Ad}_r \overline{Z}, \text{Ad}_r W)) \\
 &= \frac{1}{2i} (\kappa(E_{iX} \circ \text{Ad}_r Z, \text{Ad}_r \overline{W}) - \overline{\kappa(E_{iX} \circ \text{Ad}_r Z, \text{Ad}_r \overline{W})}) \\
 &= \text{Im} (\kappa(E_{iX} \circ \text{Ad}_r Z, \text{Ad}_r \overline{W}))
 \end{aligned}$$

We have proved:

THEOREM 5.2. $\omega(\widehat{Z}, \widehat{W}) = \text{Im} \kappa(E_{iX} \circ \text{Ad}_r Z, \text{Ad}_r \overline{W})$ is an exact, nondegenerate, J -invariant, $G_{\mathbb{R}} \times G_{\mathbb{R}}$ -invariant, real-valued 2-form on M , and coincides with the restriction to M of the standard (cotangent bundle) symplectic form on $T^*(G_{\mathbb{R}})$. \square

Recall that on any complex manifold, a closed, nondegenerate, real 2-form ω for which the complex structure is an isometry yields a pseudokähler form, by the rule $\langle \widehat{Z}, \widehat{W} \rangle = \omega(J\widehat{Z}, \widehat{W}) + i\omega(\widehat{Z}, \widehat{W})$. Here $\widehat{Z}, \widehat{W} \mapsto \omega(J\widehat{Z}, \widehat{W})$, the real part of $\langle \widehat{Z}, \widehat{W} \rangle$, is a real, J -invariant, symmetric bilinear form (which need not be positive definite), and the imaginary part of $\langle \cdot, \cdot \rangle$ is just ω .

In our situation, we have:

THEOREM 5.3. The pseudokähler form associated to ω is

$$\left\langle \widehat{Z}, \widehat{W} \right\rangle_{(iX, r)} = \kappa(E_{iX} \circ \text{Ad}_r Z, \text{Ad}_r \overline{W}) = \kappa(E_{i\text{Ad}_r^{-1} X} Z, \overline{W}). \quad \square$$

Note that 5.1(2) shows independently that $\langle \cdot, \cdot \rangle$ is Hermitian.

§6. EVALUATION OF THE PSEUDOKÄHLER FORM ON A BASIS

Our next goal is to compute $\langle \cdot, \cdot \rangle$ with respect to a natural basis of vector fields at (iX, r) , in the (generic) case that X is semisimple. Without loss of

generality, we assume that r is the identity element of $G_{\mathbb{R}}$. We use notation involving T and \mathfrak{t} as in §1.

It is clear that E_{iX} preserves \mathfrak{t} and each root space \mathfrak{g}_{α} . Hence for our Hermitian form, $\mathfrak{t} \perp \mathfrak{g}_{\alpha}$ and $\mathfrak{g}_{\alpha} \perp \mathfrak{g}_{\beta}$ unless $\bar{\beta} = -\alpha$. So, the only products we need compute are $\langle \widehat{Z}, \widehat{W} \rangle$ for $Z, W \in \mathfrak{t}$, and $\langle \widehat{Z}_{\alpha}, \widehat{Z}_{-\alpha} \rangle$, where $Z_{\alpha} \in \mathfrak{g}_{\alpha}$.

By 2.4(1) and the definition of E_{iX} , it follows easily that:

LEMMA 6.1. $E_{iX}(Z) = Z$ if $Z \in \mathfrak{t}$ (or more generally, if $[X, Z] = 0$); and if $Z_{\alpha} \in \mathfrak{g}_{\alpha}$ with $d\alpha(iX) \neq 0$, then $E_{iX}(Z_{\alpha}) = \frac{-\alpha(p^2) \cdot d\alpha(2iX)}{1 - \alpha(p^2)} Z_{\alpha}$. \square

LEMMA 6.2. For $Z, W \in \mathfrak{t}$, we have

$$\begin{aligned} \langle \widehat{Z}, \widehat{W} \rangle &= \kappa(Z, \overline{W}) \\ &= (\kappa(\operatorname{Re} Z, \operatorname{Re} W) + \kappa(\operatorname{Im} Z, \operatorname{Im} W)) \\ &\quad + i(\kappa(\operatorname{Im} Z, \operatorname{Re} W) - \kappa(\operatorname{Re} Z, \operatorname{Im} W)) \\ &= \sum_{\alpha \in \Phi(T, G)} d\alpha(Z) \cdot d\alpha(\overline{W}). \quad \square \end{aligned}$$

From this, it is easy to describe the signature of $\langle \cdot, \cdot \rangle$ on \mathfrak{t} : suppose the connected component of 1 in $T_{\mathbb{R}}$ is a product of n circles and m real lines (here $n + m$ is the complex dimension of T). Then $\langle \cdot, \cdot \rangle$ is negative-definite on the complexified Lie algebra of the circles and positive-definite on the lines, and these two subspaces of \mathfrak{t} are perpendicular. For: in computing signatures, we may assume that $Z \in \mathfrak{t}_{\mathbb{R}}$. If $Z \in \mathfrak{t}_{\mathbb{R}}$, then in the former case $d\alpha(Z) \in i\mathbb{R}$, and in the latter, $d\alpha(Z) \in \mathbb{R}$. Also for $Z \in \mathfrak{t}_{\mathbb{R}}$, $\langle Z, Z \rangle = \sum_{\alpha \in \Phi(T, G)} (d\alpha(Z))^2$. Also if $Z, W \in \mathfrak{t}_{\mathbb{R}}$ but are of “opposite types,” the last lemma shows that $\langle Z, W \rangle \in i\mathbb{R} \cap \mathbb{R} = \{0\}$.

Now let $Z = Z_{\alpha}$ and $W = \overline{Z_{-\alpha}}$. Recall that by our definition of M , we have $\alpha(p) \neq -1$. Also, either $\alpha(p) \neq 1$, or $d\alpha(iX) = 0$ and $\alpha(p) = 1$.

LEMMA 6.3. If $\alpha(p) \neq 1$, then $\langle \widehat{Z}_{\alpha}, \widehat{Z}_{-\alpha} \rangle = \frac{-\alpha(p^2) \cdot d\alpha(2iX) \cdot \kappa(Z_{\alpha}, Z_{-\alpha})}{1 - \alpha(p^2)}$, whereas if $d\alpha(iX) = 0$, then $\langle \widehat{Z}_{\alpha}, \widehat{Z}_{-\alpha} \rangle = \kappa(Z_{\alpha}, Z_{-\alpha})$. \square

This shows that if α is not imaginary, then $\langle \cdot, \cdot \rangle$ is isotropic on $\mathfrak{g}_{\alpha} \oplus \mathfrak{g}_{-\alpha}$. Suppose that α is imaginary; we wish to see whether $\langle \cdot, \cdot \rangle$ is positive- or negative-definite on \mathfrak{g}_{α} . In the copy of $sl(2)$ ($sl(\alpha) \subset \mathfrak{g}$) corresponding to α , recall that we may pick a basis $\{H_{\alpha}, Z_{\alpha}, Z_{-\alpha}\}$ satisfying $[Z_{\alpha}, Z_{-\alpha}] = H_{\alpha}$, $[H_{\alpha}, Z_{\alpha}] = 2Z_{\alpha}$, and $[H_{\alpha}, Z_{-\alpha}] = -2Z_{-\alpha}$. By explicit computation, one sees that one can pick Z_{α} satisfying $\overline{Z_{\alpha}} = \epsilon Z_{-\alpha}$, where $\epsilon = 1$ (resp. -1) if $SL(\alpha)_{\mathbb{R}}$ is noncompact (resp. compact). Then $\langle \widehat{Z}_{\alpha}, \widehat{Z}_{\alpha} \rangle = \frac{-\epsilon \cdot \alpha(p^2) \cdot d\alpha(2iX) \cdot \kappa(Z_{\alpha}, Z_{-\alpha})}{1 - \alpha(p^2)}$, or simply $\epsilon \kappa(Z_{\alpha}, Z_{-\alpha})$ if $d\alpha(iX) = 0$. In the latter case, since $\kappa(Z_{\alpha}, Z_{-\alpha}) > 0$ we

already see that $\langle \cdot, \cdot \rangle$ is positive on \mathfrak{g}_α if α is noncompact and negative if α is compact. In the former case, we get the same information: since α is imaginary, we have $d\alpha(iX) \in \mathbb{R}$, and $\alpha(p) = e^{d\alpha(iX)} > 0$. Note then that $d\alpha(iX)/(1 - \alpha(p)) < 0$; it then follows that the sign of $\langle \widehat{Z}_\alpha, \widehat{Z}_\alpha \rangle$ is ϵ .

Summarizing the above, we have:

THEOREM 6.4. *Suppose that $(iX, 1) \in M$ and $e^{iX} \in T$ for some maximal \mathbb{R} -torus T of G . Write $T = T_s \cdot T_a$, the decomposition of T into an almost direct product of split and anisotropic subtori. For each root α , let \mathfrak{g}_α be the root subspace of \mathfrak{g} . We identify elements of \mathfrak{g} with the induced tangent vectors at $(iX, 1)$ coming from the canonical vector fields. Then under the Hermitian form $\langle \cdot, \cdot \rangle$, \mathfrak{t} is perpendicular to each root space; $\text{Lie } T_a$ is perpendicular to $\text{Lie } T_s$; \mathfrak{g}_α is perpendicular to \mathfrak{g}_β unless $\beta = -\bar{\alpha}$; $\langle \cdot, \cdot \rangle$ is positive definite on $\text{Lie } T_s$ and negative definite on $\text{Lie } T_a$; $\langle \cdot, \cdot \rangle$ is isotropic on $\mathfrak{g}_\alpha \oplus \mathfrak{g}_{-\bar{\alpha}}$ if α is not imaginary; and $\langle \cdot, \cdot \rangle$ is positive (resp. negative) definite on \mathfrak{g}_α if α is noncompact imaginary (resp. compact imaginary). \square*

A priori, the signature of $\langle \cdot, \cdot \rangle$ is only constant on each connected component of M , but in fact more is true:

COROLLARY 6.5. *The signature of $\langle \cdot, \cdot \rangle$ is constant on M .*

Proof. Since $(i\mathbf{0}, 1) \in M$, there exists a connected neighborhood U of $\mathbf{0}$ in $\mathfrak{g}_\mathbb{R}$ such that $iU \times G_\mathbb{R} \subset M$. It follows that $\langle \cdot, \cdot \rangle$ has constant signature on $iU \times G_\mathbb{R}$ (note that while $G_\mathbb{R}$ need not be connected, this is irrelevant since $\langle \cdot, \cdot \rangle$ is $G_\mathbb{R}$ -invariant). We must show that the signature of $\langle \cdot, \cdot \rangle$ on any connected component of M is the same as on $iU \times G_\mathbb{R}$. Without loss of generality we may choose $(iX, r) \in M$ such that X is regular semisimple in \mathfrak{g} , which is to say that $X \in \mathfrak{t}_\mathbb{R}$ for a (unique) Cartan subalgebra $\mathfrak{t}_\mathbb{R} \subset \mathfrak{g}_\mathbb{R}$. We may find $s \in \mathbb{R}^*$ sufficiently small that $sX \in U$, and of course $sX \in \mathfrak{t}_\mathbb{R}$ is still regular semisimple. However by 6.4, the signature at $(iY, r) \in M$ (for Y regular semisimple) depends only on attributes of the unique real Cartan subalgebra containing Y and of its root system. Hence the signature of $\langle \cdot, \cdot \rangle$ at (iX, r) is the same as the signature of $\langle \cdot, \cdot \rangle$ on $iU \times G_\mathbb{R}$. \square

COROLLARY 6.6. *The signature of $\langle \cdot, \cdot \rangle$ equals the signature of the Hermitian form $Z, W \mapsto \kappa(Z, \overline{W})$ on \mathfrak{g} , which equals the signature of the (real) symmetric bilinear form $Z, W \mapsto \kappa(Z, W)$ on $\mathfrak{g}_\mathbb{R}$.*

Proof. By 6.5, it is enough to check the result at a single point of M , and at the point $(i\mathbf{0}, 1)$, $\langle Z, W \rangle = \kappa(Z, \overline{W})$. The second statement is a simple linear algebra fact. \square

7. ALTERNATIVE VECTOR FIELDS AND COMPARISON WITH FELS' WORK

Let $(iX, r) \in M$. Since $G_\mathbb{R} \times G_\mathbb{R}$ acts on M , any pair $(Y_1, Y_2) \in \mathfrak{g}_\mathbb{R} \times \mathfrak{g}_\mathbb{R}$ produces a tangent vector at (iX, r) (indeed it produces an "orbital vector field" on all of $i\mathfrak{g}_\mathbb{R} \times G_\mathbb{R}$). It is easy to see that (Y_1, Y_2) and (Y'_1, Y'_2) produce the same tangent

vector at (iX, r) if and only if $(Y'_1, Y'_2) = (Y_1 + A, Y_2 + \text{Ad}_r^{-1}A)$ for some A in the centralizer in $\mathfrak{g}_{\mathbb{R}}$ of X . Given any V in this centralizer, we obtain a (non-orbital) tangent vector to M at (iX, r) , namely $\frac{d}{dt}\big|_{t=0}(iX + itV, r)$ (however this need not be extendable to a vector field on M). By dimension count, any tangent vector to M at (iX, r) can be obtained from a combination of orbital and transverse vectors; namely, given (Y_1, Y_2, V) as above, we obtain the tangent vector $\frac{d}{dt}\big|_{t=0}(\text{Ad}_{e^{tY_1}}(iX + itV), e^{tY_1}re^{-tY_2})$, and every tangent vector can be obtained in this way. The relationship to canonical vectors is:

PROPOSITION 7.1. *At (iX, r) (with $p = e^{iX}$), the tangent vector coming from the triple (Y_1, Y_2, V) coincides with the canonical vector $(\text{Ad}_{pr}^{-1}Y_1 + i\text{Ad}_r^{-1}V - Y_2)^\wedge$.*

Proof. This is equivalent to the (straightforward) proof that $\frac{d}{dt}\big|_{t=0}(e^{tY_1}e^{iX+itV}e^{-tY_1}) \cdot (e^{tY_1}ke^{-tY_2}) = dl_{pk}(\text{Ad}_{pr}^{-1}Y_1 + i\text{Ad}_r^{-1}V - Y_2)$. \square

Fix $(iX, r) \in M$, and take (Y_1, Y_2, V_1) and (Y_3, Y_4, V_2) as above. Let $Z, W \in \mathfrak{g}$ be the corresponding canonical vectors (only valid for the point (iX, r) !). It follows from 2.4(2) and 5.1(1,2,4) that:

THEOREM 7.2. *At (iX, r) ,*

$$\begin{aligned} \langle \widehat{Z}, \widehat{W} \rangle &= \kappa(\overline{E_{iX}}Y_1, Y_3) - \kappa(F_{iX} \circ A_p Y_1, \text{Ad}_r Y_4) - \kappa(Y_1, iV_2) \\ &\quad - \kappa(F_{iX} \circ A_p \circ \text{Ad}_r Y_2, Y_3) + \kappa(E_{iX} \circ \text{Ad}_r Y_2, \text{Ad}_r Y_4) + \kappa(\text{Ad}_r Y_2, iV_2) \\ &\quad + \kappa(iV_1, Y_3) - \kappa(iV_1, \text{Ad}_r Y_4) + \kappa(iV_1, -iV_2). \quad \square \end{aligned}$$

Using 5.1(1,3,5), we can separate easily the real and imaginary parts of $\langle \widehat{Z}, \widehat{W} \rangle$:

COROLLARY 7.3.

$$\begin{aligned} \text{Re} \langle \widehat{Z}, \widehat{W} \rangle &= \kappa(F_{iX} \circ A_p \text{Re}(\text{Ad}_p Y_1), Y_3) + \kappa(F_{iX} \circ A_p \text{Re}(\text{Ad}_p \text{Ad}_r Y_2), \text{Ad}_r Y_4) \\ &\quad - \kappa(F_{iX} \circ A_p Y_1, \text{Ad}_r Y_4) - \kappa(F_{iX} \circ A_p \circ \text{Ad}_r Y_2, Y_3) + \kappa(V_1, V_2), \end{aligned}$$

and

$$\begin{aligned} \omega(\widehat{Z}, \widehat{W}) &= \text{Im} \langle \widehat{Z}, \widehat{W} \rangle \\ &= \kappa(X, [Y_1, Y_3] - \text{Ad}_r [Y_2, Y_4]) \\ &\quad + \kappa(V_1, Y_3 - \text{Ad}_r Y_4) - \kappa(Y_1 - \text{Ad}_r Y_2, V_2). \quad \square \end{aligned}$$

We recall some facts about moment maps (see [CG, Chapter 1], [HW]). Suppose that a Lie group K acts symplectically on a symplectic manifold (N, ω) . There is a map sending smooth functions on N to symplectic (=locally Hamiltonian) vector fields on N . Since G acts symplectically, there is also a map sending

each element of \mathfrak{k} to a symplectic vector field. The action of K is said to be *Hamiltonian* if there is a Lie algebra homomorphism H from \mathfrak{k} to smooth functions on N which makes a commutative triangle with the other two maps. The associated *moment map* $\mu : N \rightarrow \mathfrak{k}^*$ is the map sending $n \in N$ to the linear function on \mathfrak{k} given by $x \mapsto H_x(n)$. If the manifold in question is a cotangent bundle, with canonical 1-form λ and $\omega := d\lambda$ and with K acting on the base space, then (N, ω) is Hamiltonian, with H sending $x \in \mathfrak{k}$ to the contraction of λ with the vector field coming from the infinitesimal action of x .

In our case, $N = i\mathfrak{g}_{\mathbb{R}} \times G_{\mathbb{R}} \simeq T^*(G_{\mathbb{R}})$ and $\mathfrak{k} = \mathfrak{g}_{\mathbb{R}} \times \mathfrak{g}_{\mathbb{R}}$. Given $(Y_1, Y_2) \in \mathfrak{g}_{\mathbb{R}} \times \mathfrak{g}_{\mathbb{R}}$, the induced tangent vector at (iX, r) is $\frac{d}{dt}\Big|_{t=0} (i\text{Ad}_{e^{tY_1}} X, e^{tY_1} r e^{-tY_2})$, so by the remark at the beginning of §4, we have

$$\begin{aligned} H_{(Y_1, Y_2)} &= \kappa\left(X, \frac{d}{dt}\Big|_{t=0} e^{tY_1} r e^{-tY_2} r^{-1}\right) \\ &= \kappa(X, Y_1 - \text{Ad}_r Y_2) = \kappa(X, Y_1) - \kappa(\text{Ad}_r^{-1} X, Y_2). \end{aligned}$$

We identify $\mathfrak{g}_{\mathbb{R}}$ with $\mathfrak{g}_{\mathbb{R}}^*$ via the Killing form. We have proved:

THEOREM 7.4. *Relative to the symplectic form ω , the moment map $\mu : i\mathfrak{g}_{\mathbb{R}} \times G_{\mathbb{R}} \rightarrow \mathfrak{g}_{\mathbb{R}}^* \times \mathfrak{g}_{\mathbb{R}}^* \simeq \mathfrak{g}_{\mathbb{R}} \times \mathfrak{g}_{\mathbb{R}}$ is given by $(iX, r) \mapsto (X, -\text{Ad}_r^{-1} X)$. \square*

COROLLARY 7.5. *The image of the moment map is $\{(Y_1, Y_2) : Y_1 \text{ and } -Y_2 \text{ are } \text{Ad}(G_{\mathbb{R}})\text{-conjugate}\}$. \square*

Another easy consequence of 7.4 is:

COROLLARY 7.6. *The moment map $\mu : i\mathfrak{g}_{\mathbb{R}} \times G_{\mathbb{R}} \rightarrow \mathfrak{g}_{\mathbb{R}}^* \times \mathfrak{g}_{\mathbb{R}}^* \simeq \mathfrak{g}_{\mathbb{R}} \times \mathfrak{g}_{\mathbb{R}}$ separates $G_{\mathbb{R}} \times G_{\mathbb{R}}$ -orbits. \square*

The formula for $\omega(\widehat{Z}, \widehat{W})$ in (7.3) is essentially due to Gregor Fels [F]. Here we recall his construction in [F] of a pseudokähler form on certain complex manifolds and relate the construction to the one in this paper. (We have changed notation slightly from [F].)

Let $G_{\mathbb{R}} \subset G$ as usual, and let \mathfrak{t} be a Cartan subalgebra of \mathfrak{g} that is stable under complex conjugation. Let $\mathfrak{t}'_{\mathbb{R}}$ denote the regular semisimple elements of $\mathfrak{t}_{\mathbb{R}}$. Define $N = \{(n, n) : n \in N_{G_{\mathbb{R}}}(T_{\mathbb{R}})\} \subset G_{\mathbb{R}} \times G_{\mathbb{R}}$. Since N acts on $\mathfrak{t}'_{\mathbb{R}}$, we have the usual twisted product $(G_{\mathbb{R}} \times G_{\mathbb{R}}) *^N i\mathfrak{t}'_{\mathbb{R}}$. It is easy to see that the map

$$\Theta : (G_{\mathbb{R}} \times G_{\mathbb{R}}) *^N i\mathfrak{t}'_{\mathbb{R}} \longrightarrow M$$

given by $[(r_1, r_2), iX] \mapsto (\text{Ad}_{r_1}(iX), r_1 r_2^{-1})$ is well-defined, injective, and $G_{\mathbb{R}} \times G_{\mathbb{R}}$ -equivariant, with everywhere nonsingular differential. Moreover, the map forms one leg of a commutative triangle with the maps

$$\begin{array}{ccc} (G_{\mathbb{R}} \times G_{\mathbb{R}}) *^N i\mathfrak{t}'_{\mathbb{R}} & \rightarrow & G \\ [(r_1, r_2), iX] & \mapsto & r_1 e^{iX} r_2^{-1} \end{array} \qquad \begin{array}{ccc} & & M \rightarrow G \\ & & (iX, k) \mapsto e^{iX} k. \end{array}$$

It follows that there is a complex structure on $(G_{\mathbb{R}} \times G_{\mathbb{R}})^{*N} i\mathfrak{t}'_{\mathbb{R}}$ that agrees with the ones on G and on M .

Given the point $v = [(r_1, r_2), iX] \in (G_{\mathbb{R}} \times G_{\mathbb{R}})^{*N} i\mathfrak{t}'_{\mathbb{R}}$, one can construct (any) tangent vector as $\frac{d}{ds}\big|_{s=0}$ of the curve $s \mapsto [(r_1 e^{sY_1}, r_2 e^{sY_2}), iX + siY_3]$, where $Y_1, Y_2 \in \mathfrak{g}_{\mathbb{R}}$ and $Y_3 \in \mathfrak{t}_{\mathbb{R}}$. The J -invariant 2-form on $(G_{\mathbb{R}} \times G_{\mathbb{R}})^{*N} i\mathfrak{t}'_{\mathbb{R}}$ constructed in [F] arises as $d\theta$, where θ is the 1-form which sends the above tangent vector to $\kappa(X, Y_1 - Y_2)$. However, one can show that Θ induces an identification between the 1-forms θ and λ , and hence Θ induces an identification between (the restriction of) the pseudokähler form in the present paper and the one in [F].

8. PROOF OF THEOREM 6

Proof of (1). Write H for $GL(V)$. The map $\psi : G \rightarrow H$ induces an embedding $\psi : \mathfrak{g} \hookrightarrow \mathfrak{h}$. Since \mathfrak{g} is reductive, we can choose a G -stable complement of \mathfrak{g} in \mathfrak{h} and obtain embeddings $\Gamma : GL(\mathfrak{g}) \hookrightarrow GL(\mathfrak{h})$ and $\Gamma : \mathfrak{gl}(\mathfrak{g}) \hookrightarrow \mathfrak{gl}(\mathfrak{h})$.

Suppose that $(iX, r) \in M'$; for any eigenvalue λ of $\psi(X)$, $|\operatorname{Re} \lambda| < \pi/2$. Since the eigenvalues of $\operatorname{ad}_{\psi(X)}$ are the pairwise differences of the eigenvalues of $\psi(X)$, we have that for any eigenvalue α of $\operatorname{ad}_{\psi(X)}$, $|\operatorname{Re} \alpha| < \pi$. However $\operatorname{ad}_{\psi(X)} = \Gamma(\operatorname{ad}_X)$, and Γ is an embedding, so we can say that for any eigenvalue β of ad_X , $|\operatorname{Re} \beta| < \pi$. In particular, this shows that $(iX, r) \in M$.

Proof of (2,3). These are trivial.

Proof of (4). Let $(iX_1, r_1), (iX_2, r_2) \in M'$ and suppose that $e^{iX_1} r_1 = e^{iX_2} r_2$. Applying the map $\eta : g \mapsto g\bar{g}^{-1}$, we have that $e^{2iX_1} = e^{2iX_2}$. Applying ψ , we have $e^{\psi(2iX_1)} = e^{\psi(2iX_2)}$. Let λ be any eigenvalue of $\psi(X_1)$ or $\psi(X_2)$. By assumption, $|\operatorname{Re} \lambda| < \pi/2$, hence for any eigenvalue α of $\psi(2iX_1)$ or $\psi(2iX_2)$, we have $|\operatorname{Im} \alpha| < \pi$. By a well-known property of the exponential map for linear groups (see[V, p. 111]), we may conclude that $\psi(2iX_1) = \psi(2iX_2)$. Since ψ is injective on the level of Lie algebras, we have $X_1 = X_2$, and $r_1 = r_2$. \square

REFERENCES

- [A] V. I. Arnold, *Mathematical Methods of Classical Mechanics*, 2nd edition, GTM 60, Springer-Verlag, New York–Berlin–Heidelberg, 1989.
- [AG] D. N. Akhiezer and S. G. Gindikin, *On Stein extensions of real symmetric spaces*, Math. Ann. **286** (1990), 1–12.
- [BF] R. Bremigan and G. Fels, *Bi-invariant domains in semisimple groups: non-principal orbits and boundaries*, Geometriae Dedicata **82** (2000), 225–283.
- [CG] N. Chriss & V. Ginzburg, *Representation Theory and Complex Geometry*, Birkhäuser, Boston–Basel–Berlin, 1997.
- [F] G. Fels, *Pseudokählerian structure on domains in a complex semisimple Lie group*, Math. Ann. (to appear).
- [HW] A. T. Huckleberry and T. Wurzbacher, *Multiplicity-free complex manifolds*, Math. Ann. **286** (1990), 261–280.
- [V] V.S. Varadarajan, *Lie Groups, Lie Algebras, and Their Representations*, GTM 102, Springer-Verlag, New York–Berlin–Heidelberg–Tokyo, 1984.

Ralph J. Bremigan
Department of Mathematical Sciences
Ball State University
Muncie, IN 47306–0490, USA
bremigan@math.bsu.edu

STRONGLY HOMOTOPY-COMMUTATIVE
MONOIDS REVISITED

MICHAEL BRINKMEIER

Received: September 22, 1999

Revised: November 11, 2000

Communicated by Günter M. Ziegler

ABSTRACT. We prove that the delooping, i. e., the classifying space, of a grouplike monoid is an H -space if and only if its multiplication is a homotopy homomorphism, extending and clarifying a result of Sugawara. Furthermore it is shown that the Moore loop space functor and the construction of the classifying space induce an adjunction of the according homotopy categories.

2000 Mathematics Subject Classification: Primary 55P45, 55P35; Secondary 55R35

Keywords and Phrases: H -spaces, Classifying space, Monoid, Strongly homotopy commutative, Homotopy homomorphism

INTRODUCTION

In [Sug60] Sugawara examined structures on topological monoids, which induce H -space multiplications on the classifying spaces. He introduced a form of coherently homotopy commutative monoids, which he called *strongly homotopy commutative*. His main result is that a countable CW -group G is strongly homotopy-commutative if and only if its classifying space BG is an H -space. The proof proceeds as follows. One first shows that the multiplication $G \times G \rightarrow G$ of a strongly homotopy commutative group is a homotopy homomorphism (Sugawara called such maps strongly homotopy multiplicative), i.e. a homomorphism up to coherent homotopies. Then one shows that this map induces an H -space structure on BG . The proof of the converse is very sketchy and far from convincing.

We start with an easy to handle reformulation of the notion of homotopy homomorphisms. The well-pointed and grouplike monoids (cmp. Def. 2.4) and

homotopy classes of these homotopy homomorphisms form a category $\mathcal{H}\mathbf{Gr}_H$. If \mathfrak{Top}_H^* is the category of well-pointed spaces and based homotopy classes of maps, then the classifying space and the Moore loop space functors induces functors $B_H : \mathcal{H}\mathbf{Gr}_H \rightarrow \mathfrak{Top}_H^*$ and $\Omega_H : \mathfrak{Top}_H^* \rightarrow \mathcal{H}\mathbf{Gr}_H$. We first prove the following strengthening of a result of Fuchs ([Fuc65]).

THEOREM (3.7). *The functor B_H is left adjoint to Ω_H .*

The adjunction induces an equivalence of the full subcategories of monoids in $\mathcal{H}\mathbf{Gr}_H$ of the homotopy type of CW-complexes and of the full subcategory of \mathfrak{Top}_H^ of connected spaces of the homotopy type of CW-complexes.*

We then reexamine Sugawara's result starting with grouplike monoids whose multiplications are homotopy homomorphisms. They give rise to H -objects (i.e. Hopf objects) in the category $\mathcal{H}\mathbf{Gr}_H$. We obtain the following extension of Sugawara's theorem.

THEOREM (3.8 AND 4.2). *The classifying space of a grouplike and well-pointed monoid M is an H -space if and only if M is an H -object in $\mathcal{H}\mathbf{Gr}_H$.*

As mentioned above the multiplication of a strongly homotopy commutative monoid is a homotopy homomorphism. We were not able to prove the converse and consider it an open question.

I would like to thank Rainer Vogt for his guidance and help during the preparation of this paper, and James Stasheff for his corrections and suggestions. The author was supported by the Deutsche Forschungsgemeinschaft.

1 THE W-CONSTRUCTION

Let \mathbf{Mon} be the category of well-pointed, topological monoids and continuous homomorphisms between them. Here well-pointed means, that the inclusion of the unit is a closed cofibration.

Remark 1.1. One can functorially replace any monoid M by well-pointed one by adding a whisker (cmp. [BV68], pg 1130f.). This does not change the (unbased) homotopy type of M .

DEFINITION 1.2. Let M and N be topological monoids. A homotopy $H_t : M \rightarrow N$ is called a *homotopy through homomorphisms* if for each $t \in I$ the map $H_t : M \rightarrow N$ is a homomorphism.

DEFINITION 1.3. (cmp. [BV73], [Vog73], [SV86]) We define a functor $W : \mathbf{Mon} \rightarrow \mathbf{Mon}$. For $M \in \mathbf{ob} \mathbf{Mon}$ the monoid WM is the space

$$WM = \coprod_{n \in \mathbb{N}} M^{n+1} \times I^n / \sim$$

with the relation

$$(x_0, t_1, x_1, \dots, t_n, x_n) = \begin{cases} (x_0, \dots, t_{i-1}, x_{i-1}x_i, t_{i+1}, \dots, x_n) & \text{for } t_i = 0 \\ (x_1, t_2, \dots, x_n) & \text{for } x_0 = e \\ (x_0, \dots, x_{i-1}, \max(t_i, t_{i+1}), x_{i+1}, \dots, x_n) & \text{for } x_i = e \\ (x_0, \dots, t_{n-1}, x_{n-1}) & \text{for } x_n = e. \end{cases}$$

The multiplication is given by

$$(x_0, \dots, t_n, x_n) \cdot (y_0, s_1, \dots, y_k) = (x_0, \dots, t_n, x_n, 1, y_0, s_1, \dots, y_k).$$

A continuous homomorphism $F : M \rightarrow N$ is mapped to $WF : WM \rightarrow WN$ with

$$WF(x_0, t_1, x_1, \dots, x_n) = (F(x_0), t_1, F(x_1), \dots, F(x_n)).$$

The *augmentation* $\varepsilon_M : WM \rightarrow M$ with $\varepsilon_M(x_0, \dots, x_n) = x_0 \cdots x_n$ defines a natural transformation $\varepsilon : W \rightarrow \text{id}$. If $i_M : M \rightarrow WM$ is the inclusion, which maps every element x of M to the chain (x) , we get $\varepsilon_M \circ i_M = \text{id}_M$ and a non-homomorphic homotopy $h_t : WM \rightarrow WM$ from $i_M \circ \varepsilon_M$ to id_{WM} , given by

$$h_t(x_0, t_1, x_1, \dots, t_n, x_n) = (x_0, tt_1, x_1, \dots, tt_n, x_n).$$

Therefore ε_M is a homotopy equivalence and M a strong deformation retract of WM at *space level*, i.e. its homotopy inverse is no homomorphism.

One of the most important properties of the W -construction is the following lifting theorem, which is a slight variation of [SV86, 4.2] and is proven in the same way.

THEOREM 1.4. *Given the following diagram in **Mon** with $0 \leq n \leq \infty$ such that*

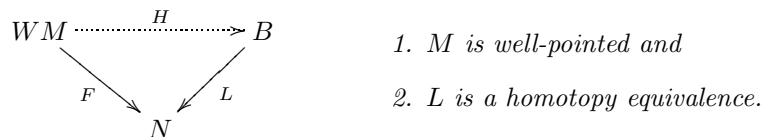

Then there exists a homomorphism $H : WM \rightarrow B$ and a homotopy $K_t : WM \rightarrow N$ through homomorphisms from $L \circ H$ to F . Furthermore H is unique up to homotopy through homomorphisms.

2 HOMOTOPY HOMOMORPHISMS

DEFINITION 2.1. Let M and N be two well-pointed monoids. A *homotopy homomorphism* F from M to N is a homomorphism $F : WM \rightarrow WN$. The map $f := \varepsilon_N \circ F \circ i_M : M \rightarrow N$ is the *underlying map* of F .

Let $\mathcal{H}\mathbf{Mon}$ be the category whose objects are well-pointed, topological monoids, and whose morphisms are homotopy homomorphisms.

Remark 2.2. Our homotopy homomorphisms are closely related to Sugawara's approach. If we compose a homotopy homomorphism with the augmentation, we obtain a map $WM \rightarrow N$ which is, up to the conditions for the unit, a strong homotopy multiplicative map in Sugawara's sense. Since ε_N is a homotopy equivalence, the resulting structures are equivalent, after passage to the homotopy category.

The Moore loop-space construction $\Omega_M X$ and the classifying space functor B define functors $\Omega_W : \mathfrak{Top}^* \rightarrow \mathcal{HMon}$ and $B_W : \mathcal{HMon} \rightarrow \mathfrak{Top}^*$ by $\Omega_W(X) = \Omega_M X$ and $B_W(M) = B(WM)$ on objects and $\Omega_W(f) = W\Omega_M f$ and $B_W(F) = BF$ on morphisms.

For a based map $f : X \rightarrow Y$ let $[f]_*$ denote its based homotopy class. For a homomorphism F of monoids let $[F]$ denote its homotopy class with respect to homotopies through homomorphisms.

Let \mathfrak{Top}_H^* be the category of based, well-pointed spaces and based homotopy classes of based spaces and \mathcal{HMon}_H the category of well-pointed monoids and homotopy classes of homotopy homomorphisms.

Remark 2.3. One can prove that the homotopy homomorphisms, which are homotopy equivalences on space level, represent isomorphisms in \mathcal{HMon}_H .

Since Ω_W and B_W preserve homotopies, they induce a pair of functors

$$B_H : \mathfrak{Top}_H^* \rightleftarrows \mathcal{HMon}_H : \Omega_H$$

DEFINITION 2.4. A monoid M with multiplication μ and unit e is called *grouplike*, if there a continuous map $i : M \rightarrow M$ such that the maps $x \mapsto \mu(x, i(x))$ and $x \mapsto \mu(i(x), x)$ are homotopic to the constant map on e .

Since the Moore loop-spaces are grouplike and since this notion is homotopy invariant, an additional restriction is necessary for Theorem 3.7 to be true. Let \mathcal{HGr} be the full subcategory of \mathcal{HMon} , whose objects are grouplike, and let \mathcal{HGr}_H be the corresponding homotopy category. Then B_H and Ω_H give rise to a pair of functors

$$B_H : \mathfrak{Top}_H^* \rightleftarrows \mathcal{HGr}_H : \Omega_H.$$

We make use of a construction from [SV86]. For an arbitrary monoid M let EM be the contractible space with right M -action such that $EM/M \simeq BM$. We define a monoid structure on the Moore path space

$$P(EM; e, M) := \{(\omega, l) \in EM^{\mathbb{R}_+} \times \mathbb{R}_+ : \omega(0) = e, \omega(l) \in M, \omega(t) = \omega(l) \text{ for } t \geq l\}.$$

The product of two paths (ω, l) and (ν, k) is given by $(\rho, l+k)$, with

$$\rho(t) = \begin{cases} \omega(t) & \text{if } 0 \leq t \leq l \\ \omega(l) \cdot \nu(t-l) & \text{if } l \leq t \leq l+k. \end{cases}$$

The end-point projection $\pi_M : P(EM; e, M) \rightarrow M, (\omega, l) \mapsto \omega(l)$ a continuous homomorphism. Since $P(EM; e, M)$ is the homotopy fiber of the inclusion $i : M \hookrightarrow EM$ and since EM is contractible, π_M is a homotopy equivalence. By Theorem 1.4 there exists a homomorphism $\bar{T}_M : WM \rightarrow P(EWM; e, WM)$ such that the following diagram commutes up to homotopy through homomorphisms.

$$\begin{array}{ccc}
 WM & \xrightarrow{\bar{T}_M} & P(EWM; e, WM) \\
 & \searrow & \swarrow \pi_{WM} \\
 & WM &
 \end{array}$$

Because π_{WM} is strictly natural in WM , \bar{T}_M is natural up to homotopy through homomorphism.

Obviously we have $P(BWM, *, *) = \Omega_M BWM$. Hence the projection $p_{WM} : EWM \rightarrow BWM$ induces a natural homomorphism $P(p_{WM}) : P(EWM; e, WM) \rightarrow \Omega_M BWM$. Because WM is grouplike, $P(p_{WM})$ is a homotopy equivalence. Therefore we obtain a homomorphism $T_M : WM \rightarrow W\Omega_M BWM$, which is induced by Theorem 1.4 and the following diagram.

$$\begin{array}{ccc}
 WM & \xrightarrow{T_M} & W\Omega_M BWM \\
 \bar{T}_M \downarrow & & \downarrow \varepsilon_{\Omega_M BWM} \\
 P(EWM; e, WM) & \xrightarrow{P(p_M)} & \Omega_M BWM
 \end{array}$$

Since all morphisms are natural up to homotopy through homomorphisms, the T_M form a natural transformation $[T]$ from $\text{id}_{\mathcal{HGr}_H}$ to $\Omega_H B_H$ and each T_M is a homotopy equivalence and hence an isomorphism in \mathcal{HGr}_H . Its inverse $[K_M]$ can be constructed by Theorem 1.4 and the following diagram.

$$\begin{array}{ccc}
 W\Omega_M BWM & \xrightarrow{\dots\dots\dots K_M \dots\dots\dots} & WM \\
 & \searrow & \swarrow T_M \\
 & W\Omega_M BWM &
 \end{array}$$

For each well-pointed space X , we chose E_X to be the dotted arrow in the following diagram.

$$\begin{array}{ccc}
 BW\Omega_M BW\Omega_M X & \xrightarrow{BK_{\Omega_M X}} & BW\Omega_M X \\
 B\varepsilon_{\Omega_M BW\Omega_M X} \downarrow & & \downarrow B\varepsilon_{\Omega_M X} \\
 B\Omega_M BW\Omega_M X & & B\Omega_M X \\
 e_{BW\Omega_M X} \downarrow & & \downarrow e_X \\
 BW\Omega_M X & \xrightarrow{\dots\dots\dots E_X \dots\dots\dots} & X
 \end{array}$$

Here the e_\bullet are the maps described in Proposition 5.1. Since all solid arrows, except for e_X , are based homotopy equivalences the morphism E_X exists and is uniquely determined up to based homotopy. The naturality of E_X follows from the naturality up to homotopy of all other maps. Hence we have a natural transformation $[E]_*$ from $B_H\Omega_H$ to the identity on \mathfrak{Top}_H^* .

THEOREM 2.5. *The functor $B_H : \mathcal{HGr}_H \rightarrow \mathfrak{Top}_H^*$ is left adjoint to Ω_H . The natural isomorphism $[T]$ is the unit, and the natural transformation $[E]_*$ the counit of this adjunction.*

Proof. The definition of E_{BWM} and the naturality of several morphisms imply

$$[E_{BWM} \circ BT_M \circ e_{BWM}]_* = [e_{BWM}]_*$$

and since e_{BWM} is a based homotopy equivalence by Proposition 5.1 this results in

$$[E_{B_H(M)}]_* \circ B_H[T_M] = [E_{BWM}]_* \circ [BT_M]_* = [\text{id}_{B_M}]_*.$$

The definition of E_X implies

$$[W\Omega_M E_X \circ W\Omega_M e_{BW\Omega_M X} \circ W\Omega_M B\varepsilon_{\Omega_M BW\Omega_M X} \circ W\Omega_M BT_{\Omega_M X}] = [W\Omega_M e_X \circ W\Omega_M B\varepsilon_{\Omega_M X}]$$

and the naturality of several maps leads to

$$[W\Omega_M E_X \circ W\Omega_M e_{BW\Omega_M X} \circ W\Omega_M B\varepsilon_{\Omega_M BW\Omega_M X} \circ W\Omega_M BT_{\Omega_M X}] = [W\Omega_M e_X \circ W\Omega_M B\varepsilon_{\Omega_M X} \circ W\Omega_M BW\Omega_M E_X \circ W\Omega_M BT_{\Omega_M X}].$$

Since $\varepsilon_{\Omega_M X}$ and $\Omega_M e_X$ are homotopy equivalences the homomorphisms $W\Omega_M e_X$ and $W\Omega_M B\varepsilon_{\Omega_M X}$ represent isomorphisms in \mathcal{HGr}_H . Therefore we have

$$[W\Omega_M BW\Omega_M E_X \circ W\Omega_M BT_{\Omega_M X}] = [\text{id}_{W\Omega_M BW\Omega_M X}].$$

The facts that $T_{\Omega_M X}$ is an isomorphism in \mathcal{HGr}_H and that

$$[T_{\Omega_M X} \circ W\Omega_M E_X \circ T_{\Omega_M X}] = [W\Omega_M BW\Omega_M E_X \circ W\Omega_M BT_{\Omega_M X} \circ T_{\Omega_M X}]$$

imply

$$\Omega_H[E_X]_* \circ [T_{\Omega_H(X)}] = [W\Omega_M E_X \circ T_{\Omega_M X}] = [\text{id}_{W\Omega_M X}]. \quad \square$$

3 HOPF-OBJECTS

DEFINITION 3.1. An H - or *Hopf-object* (X, μ, ρ) in a monoidal category¹ $(\mathcal{C}, \otimes, e)$ is a non-associative monoid, i.e. an object X of \mathcal{C} together with morphisms $\mu : X \otimes X \rightarrow X$ and $\rho : e \rightarrow X$ such that the following diagram commutes.

$$\begin{array}{ccccc}
 e \otimes X & \xrightarrow{\rho \otimes \text{id}_X} & X \otimes X & \xleftarrow{\text{id}_X \otimes \rho} & X \otimes e \\
 & \searrow \simeq & \downarrow \mu & \swarrow \simeq & \\
 & & X & &
 \end{array}$$

A morphism of H -objects (or H -morphism) $f : X \rightarrow Y$ is a morphism such that $\mu_Y \circ (f \otimes f) = f \circ \mu_X$. The H -objects of \mathcal{C} and the H -morphisms form a category $\text{Hopf}\mathcal{C}$.

PROPOSITION 3.2. Let $(\mathcal{C}, \odot, e_{\mathcal{C}})$ and $(\mathcal{D}, \otimes, e_{\mathcal{D}})$ be monoidal categories and

$$(F, G, \eta, \varepsilon) : \mathcal{C} \rightarrow \mathcal{D}$$

an adjunction of monoidal functors² such that the diagrams

$$\begin{array}{ccccc}
 Y \odot Y & \xrightarrow{\eta_Y \odot \eta_Y} & GFY \odot GFY & FGX \otimes FGX & \longrightarrow & F(GX \odot GX) \\
 \downarrow \eta_{Y \odot Y} & & \downarrow & \varepsilon_X \otimes \varepsilon_X \downarrow & & \downarrow \\
 GF(Y \odot Y) & \longleftarrow & G(FY \otimes FY) & X \otimes X & \longleftarrow & FG(X \otimes X)
 \end{array}$$

commute for each $X \in \mathcal{C}$ and $Y \in \mathcal{D}$, then there exists an adjoint pair of functors

$$\text{Hopf}F : \text{Hopf}\mathcal{H}\mathcal{C} \rightleftarrows \text{Hopf}\mathcal{D} : \text{Hopf}G.$$

Proof. $\text{Hopf}F$ is given by

$$\text{Hopf}F(X, \mu, \rho) = (FX, F\mu \circ \varphi, F\rho) \text{ and } \text{Hopf}F(f) = Ff,$$

with $\varphi : FX \otimes FX \rightarrow F(X \odot X)$ the natural transformation. Its adjoint $\text{Hopf}G$ is given analogously. The two commutative diagrams imply that the units η_X and the counits ε_Y of the adjunction are H -morphisms. Therefore they form the unit and counit of an adjunction. \square

Example 3.3. \mathfrak{Top}_H^* with its product is a monoidal category. The H -objects in \mathfrak{Top}_H^* are precisely the H -spaces with the base point as unit. The homotopy class $[\mu]_*$ of the multiplication is called H -space structure of X . H -morphisms are the homotopy classes of H -space morphisms up to homotopy.

¹For a definition of monoidal categories see [McL71].
²For a definition of monoidal functors see [BFSV98]

Example 3.4. \mathcal{HGr}_H has a monoidal structure \otimes given on objects by $M \otimes N = M \times N$. For morphisms $F : WM \rightarrow WM'$ and $G : WN \rightarrow WN'$ we define $F \otimes G : W(M \times N) \rightarrow W(M' \times N')$ as follows: Let $S_{M,N} = (W\text{pr}_M, W\text{pr}_N) : W(M \times N) \rightarrow WM \times WN$ be induced by the two projections. Then the diagram

$$\begin{array}{ccc} W(M \times N) & \xrightarrow{S_{M,N}} & WM \times WN \\ & \searrow \varepsilon_{M \times N} & \swarrow \varepsilon_{M \times N} \\ & M \times N & \end{array}$$

commutes. Obviously $S_{M,N}$ is a homotopy equivalence. By Theorem 1.4 the homotopy class of $S_{M,N}$ in \mathcal{HMon} is uniquely determined.

For two homotopy homomorphisms $F : WM \rightarrow WM'$ and $G : WN \rightarrow WN'$, we define $F \otimes G : W(M \times N) \rightarrow W(M' \times N')$ to be the lifting in the following diagram.

$$\begin{array}{ccc} W(M \times N) & \xrightarrow{F \otimes G} & W(M' \times N') \\ S_{M,N} \downarrow & & \downarrow S_{M',N'} \\ WM \times WN & \xrightarrow{F \times G} & WM' \times WN' \end{array}$$

This construction is compatible with the composition and we can define a functor $\otimes : \mathcal{HGr}_H \times \mathcal{HGr}_H \rightarrow \mathcal{HGr}_H$ with $M \otimes N = M \times N$ and $[F] \otimes [G] = [F \otimes G]$.

The projections $[P_M]$ and $[P_N]$ on $M \otimes N$ are given by $[p_i \circ S_{M,N}]$, where p_i is the according projection from $WM \times WN$. It is easy to check that \otimes and these projections form a product in \mathcal{HGr}_H and that the trivial monoid $*$ is a terminal and initial object of \mathcal{HGr}_H . Therefore \mathcal{HGr}_H is monoidal and we have a notion of H -objects in \mathcal{HGr}_H .

The unit of an H -object in \mathcal{HGr}_H is always the unit of the underlying monoid.

LEMMA 3.5. *If $(M, [F])$ is a H -object in \mathcal{HGr}_H , then the underlying map f of F is homotopic to the multiplication μ of M .*

Proof. The homomorphism $\bar{F} = \varepsilon_M \circ F$ has the property $[\bar{F} \circ Wi_k] = [\varepsilon_M]$ for $k = 1, 2$. The homotopy $h_t : M \times M \rightarrow M$ with $h_t(x, y) = \bar{F}((x, e), t, (e, y))$ runs from $f(x, y)$ to $f(x, e)f(e, y)$, and hence f and μ are based homotopic. \square

Thus the multiplication μ of an H -object $(M, [F])$ in \mathcal{HGr}_H is homotopic to the underlying map of F , and therefore homotopy-commutative with the commuting homotopy from xy to yx derived from $F((e, y), t, (x, e))$. The relations in $W(M \times M)$ define higher homotopies so that the underlying monoid is homotopy commutative in a strong sense.

We now want to examine the structure on a monoid M , that leads to the existence of an H -space multiplication on its classifying space.

PROPOSITION 3.6. *B_H and Ω_H are monoidal functors.*

Proof. For $M, N \in \mathcal{HGr}_H$ the morphism

$$s_{M,N} : BW(M \times N) \rightarrow BWM \times BWN$$

is given by the based homotopy equivalence (BWp_1, BWp_2) , where $p_1, p_2 : M \times M \rightarrow M$ are the projections.

For $X, Y \in \mathfrak{Top}_H^*$ the morphism $\Omega_H(X \times Y) \simeq \Omega_H X \otimes \Omega_H Y$ is given by $W(\Omega_M p_1, \Omega_M p_2) : W\Omega_M(X \times Y) \rightarrow W(\Omega_M X \times \Omega_M Y)$. \square

Theorem 3.2 now implies

THEOREM 3.7. B_H and Ω_H induce an adjunction

$$Hopf B_H : Hopf \mathcal{HGr}_H \rightleftarrows Hopf \mathfrak{Top}_H^* : Hopf \Omega_H$$

with

$$Hopf B_H(M, [F]) = (BWM, [BF \circ s_{M,M}]_*)$$

and

$$Hopf \Omega_H(X, [\mu]_*) = (\Omega_M X, [W\Omega_M \mu \circ R_{X,X}]).$$

THEOREM 3.8. *The classifying space BM of a grouplike and well-pointed monoid M is an H -space if and only if M is an H -object in \mathcal{HGr}_H .*

Proof. If M is an H -object, then BWM and thus BM are H -spaces. Now let BM be an H -space. Then $\Omega_M BWM$ is an H -object in $Hopf \mathcal{HGr}_H$. Since $T_M : WM \rightarrow W\Omega_M BWM$ is a homotopy equivalence, M is an H -object, too. \square

4 EXTENSIONS

A monoid in $Hopf \mathfrak{Top}_H^*$ is a homotopy-associative H -space (X, μ) . A monoid $Hopf \mathcal{HGr}_H$ consists of a well-pointed and grouplike monoid together with homotopy homomorphisms $F_2 : W(M \times M) \rightarrow WM$ and $F_3 : W(M \times M \times M) \rightarrow WM$ such that $(M, [F_2])$ is an H -object and

$$[F_2 \circ (F_2 \otimes \text{id})] = [F_3] = [F_2 \circ (\text{id} \otimes F_2)].$$

We call the H -object $(M, [F_2])$ *associative*.

Since these structures are invariant under isomorphisms we obtain, similar to the non-associative case, the following

THEOREM 4.1. *The classifying space BM of a well-pointed, grouplike monoid M is an homotopy associative H -space, if M is an associative H -object in \mathcal{HGr}_H .*

As we realized earlier, the morphism $e_X : B\Omega_M X \rightarrow X$ need not be a homotopy equivalence. But by Proposition 5.1 $\Omega_M e_X$ is a based homotopy equivalence. Hence, if we restrict to connected, based spaces of the homotopy type of CW -complexes, e_X is a homotopy equivalence.

This implies that the adjunction

$$B_H : \mathcal{HGr}_H \rightleftarrows \mathfrak{Top}_H^* : \Omega_H$$

induces an equivalence of categories, if we restrict to the full subcategories of based spaces of the homotopy type of connected CW -complexes and grouplike monoids of the homotopy type of CW -complexes.

THEOREM 4.2. *The full subcategories $\text{Hopf}\mathcal{HGr}_H^{CW} \subset \text{Hopf}\mathcal{HGr}_H$ of H -objects of the homotopy type of CW -complexes, and $\text{Hopf}\mathfrak{Top}_H^{*,CW} \subset \text{Hopf}\mathfrak{Top}_H^*$ of connected H -spaces of the homotopy type of CW -complexes, are equivalent.*

5 APPENDIX: THE EVALUATION MAP

This section is dedicated to the proof of the following theorem.

PROPOSITION 5.1. *For each based space X there exists a natural map $e_X : B\Omega_M X \rightarrow X$ such that*

1. $\Omega_M e_X$ is a homotopy equivalence for each based space X and
2. if M is a grouplike well-pointed monoid then e_{BM} is a homotopy equivalence.

To prove this we will use based simplicial spaces. A *based simplicial space* is a functor from the dual of the category Δ of finite, ordered sets $[n] = \{0, 1, \dots, n\}$ to \mathfrak{Top}_* . The *based standard simplices* $\nabla_*(n)$ are given by the quotient space $\nabla(n)/V_n$ with $\nabla(n)$ the n -th standard simplex and V_n its subspace of vertices. They induce a based cosimplicial space $\nabla_* : \Delta \rightarrow \mathfrak{Top}_*$.

We define the *based geometric realization* of a based simplicial space \mathfrak{X} as

$$|\cdot|_* = \coprod_n \mathfrak{X}(n) \wedge \nabla_*(n) / \sim$$

with the relation \sim generated by the same equalities as in the unbased case. This induces a functor $|\cdot|_*$ from the category of based simplicial spaces to \mathfrak{Top}_* . Analogous to the unbased singular complex we can define the *based singular complex* $S_* X : \Delta^{op} \rightarrow \mathfrak{Top}_*$ of a based space X by

$$[n] \mapsto \mathfrak{Top}_*(\nabla_*(n), X).$$

S_* induces a functor from \mathfrak{Top}_* to the category of based simplicial sets. As in the unbased case this right adjoint to the based realization $|\cdot|_*$. The unit $\tau_* : \text{id} \rightarrow S_* |\cdot|_*$ is given by

$$\tau_{*,\mathfrak{X}}(x) = (t \mapsto (x, t)), \quad x \in \mathfrak{X}_n, t \in \nabla_*(n)$$

and the counit $\eta_* : |S_* \cdot|_* \rightarrow \text{id}$ by

$$\eta_{*,X}(\omega, t) = \omega(t), \quad \omega \in S_*Y(n), t \in \nabla_*(n).$$

DEFINITION 5.2. (cmp. [Seg74, A.4.]) A based simplicial space \mathfrak{X} is *good* if for each n and $0 \leq i \leq n$ the inclusion $s_i(\mathfrak{X}_{n-1}) \hookrightarrow \mathfrak{X}_n$ is a closed cofibration.

Now observe that the based realization $|\mathfrak{X}|_*$ coincides with the unbased realization $|\mathfrak{X}|$ if the simplicial space \mathfrak{X} has only one 0-simplex. Therefore we obtain the following lemma from well-known facts.

LEMMA 5.3. (cmp. [Seg74, A.1]) Let \mathfrak{X} and \mathfrak{Y} be good, based simplicial spaces with $\mathfrak{X}_0 = * = \mathfrak{Y}_0$ and let $f : \mathfrak{X} \rightarrow \mathfrak{Y}$ be a based simplicial map. If each map f_n is a based homotopy equivalence, then the map

$$|f|_* : |\mathfrak{X}|_* \rightarrow |\mathfrak{Y}|_*$$

is a based homotopy equivalence.

In the following we will show that the nerve $\Omega_M^\bullet X$ of the Moore loop space of an arbitrary well-pointed space X is homotopy equivalent to its based simplicial complex. There exists a based simplicial map $a : \Omega_M^\bullet X \rightarrow S_*X$, given by

$$a_n(\omega_1, \dots, \omega_n)(t_0, \dots, t_n) = (\omega_1 + \dots + \omega_n) \left(\sum_{i=1}^n \sum_{j=1}^i t_i l_j \right)$$

(l_j is the length of the loop ω_j and $+$ the loop addition). Let $\epsilon_j = (t_0, \dots, t_n)$ be the vertex of $\nabla(n)$ given by $t_j = 1, t_k = 0, k \neq j$. Then a maps the loop ω_j to the edge running from ϵ_{j-1} to ϵ_j .

$E_n := \{(t_0, \dots, t_n) \in \nabla(n) : t_i + t_{i+1} = 1 \text{ for some } i\}$ is a strong deformation retract of $\nabla(n)$ and there exists a sequence of homotopy equivalences

$$\mathfrak{Top}_*(\nabla_*(n), X) \simeq \mathfrak{Top}_*(E_n, X) \simeq (\Omega X)^n \simeq (\Omega_M X)^n$$

such that the composition of a with these maps is the endomorphism of $(\Omega_M X)^n$ which changes the length of the loops to length 1. This map is homotopic to the identity, and hence a is a homotopy equivalence. Furthermore a is natural in X and defines a natural transformation from Ω_M^\bullet to S_* . If X and hence $\Omega_M X$ and $\mathfrak{Top}_*(\nabla_*(n), X)$ are well-pointed, then a_X is a based homotopy equivalence.

The map $e_X := \eta_{*,X} \circ |a_X|_* : |\Omega_M^\bullet X|_* \rightarrow X$ is natural in X and therefore induces a natural transformation from $|\Omega_M^\bullet \cdot|_*$ to id . Since Ω_M^\bullet is the nerve of a topological monoid, e is in fact a natural transformation from $B\Omega_M$ to $\text{id}_{\mathfrak{Top}_*}$.

By [Seg74, 1.5] the canonical map $\tau_{\Omega_M X} : \Omega_M X \rightarrow \Omega B\Omega_M X$ with $\tau_{\Omega_M X}(\omega)(t) = (\omega; 1-t, t)$ is a homotopy equivalence because $\Omega_M X$ is grouplike. The composition $\Omega e_X \circ \tau_{\Omega_M X} : \Omega_M X \rightarrow \Omega X$ is the map normalizing the loops

to length 1 and hence a homotopy equivalence. Therefore Ωe_X is a homotopy equivalence. Since the maps $\Omega_M X \rightarrow \Omega X$ are natural in X , this implies the first statement of Proposition 5.1.

Let M be a well-pointed grouplike monoid. Using the adjunction of the based realization and the based singular complex functors, we obtain a sequence

$$BM = |M^\bullet|_* \xrightarrow{|\tau_{*,M^\bullet}|_*} |S_*BM|_* \xrightarrow{\eta_{*,BM}} |M^\bullet|_* = BM$$

The map $\eta_{*,BM} \circ |\tau_{*,M^\bullet}|_*$ is the identity. $S_*BM(1)$ is precisely the non-associative loop space ΩBM and, by [Seg74, 1.5], the map τ_{*,M^\bullet} is a homotopy equivalence on the 1-simplices. Furthermore $S_*BM(n)$ is based homotopy equivalent to $(\Omega_M BM)^n$ and $S_*BM(n)$ is special, i.e. it satisfies the conditions of [Seg74, 1.5]. Therefore τ_{*,M^\bullet} is a based homotopy equivalence in each dimension and thus $|\tau_{*,M^\bullet}|_*$ and $\eta_{*,BM}$. Since $|a_{BM}|_*$ is a based homotopy equivalence this implies the second statement of Proposition 5.1.

REFERENCES

- [BFSV98] C. Balteanu, Z. Fiedorowicz, R. Schwänzl, and R. Vogt. Iterated monoidal categories II. preprint 98–035, Universität Bielefeld, 1998.
- [BV68] J.M. Boardman and R.M. Vogt. Homotopy-everything H-spaces. *Bull. Amer. Math. Soc.*, 74:1117–1122, 1968.
- [BV73] J.M. Boardman and R.M. Vogt. *Homotopy Invariant Algebraic Structures on Topological Spaces*, volume 347 of *Lecture Notes in Mathematics*. Springer, Berlin, 1973.
- [Fuc65] M. Fuchs. Verallgemeinerte Homotopie-Homomorphismen und klassifizierende Räume. *Math. Annalen*, 161:197–230, 1965.
- [McL71] S. McLane. *Categories for the Working Mathematician*. Graduate Texts in Mathematics. Springer, Berlin, 1971.
- [Seg74] G. Segal. Categories and cohomology theories. *Topology*, 13:293–312, 1974.
- [Sug60] M. Sugawara. On the homotopy-commutativity of groups and loop spaces. *Mem. Coll. Sci. Univ. Kyoto, Ser. A*, 33:257–269, 1960.
- [SV86] R. Schwänzl and R.M. Vogt. *Coherence in Homotopy Group Actions*, volume 1217 of *Lecture Notes in Mathematics*, pages 364–390. Springer, Berlin, 1986.
- [Vog73] R.M. Vogt. Homotopy limits and colimits. *Math. Z.*, 134:11–52, 1973.

Michael Brinkmeier
 Fachbereich Mathematik/Informatik
 Universität Osnabrück
 49069 Osnabrück, Germany
 mbrinkme@mathematik.Uni-Osnabrueck.DE

PSEUDODIFFERENTIAL ANALYSIS
ON CONTINUOUS FAMILY GROUPOIDS

ROBERT LAUTER¹, BERTRAND MONTHUBERT, VICTOR NISTOR²

Received: September 13, 2000

Communicated by Joachim Cuntz

ABSTRACT. We study properties and representations of the convolution algebra and the algebra of pseudodifferential operators associated to a continuous family groupoid. We show that the study of representations of the algebras of pseudodifferential operators of order zero completely reduces to the study of the representations of the ideal of regularizing operators. This recovers the usual boundedness theorems for pseudodifferential operators of order zero. We prove a structure theorem for the norm completions of these algebras associated to groupoids with invariant filtrations. As a consequence, we obtain criteria for an operator to be compact or Fredholm. We end with a discussion of the significance of these results to the index theory of operators on certain singular spaces. For example, we give a new approach to the question of the existence of spectral sections for operators on coverings of manifolds with boundary. We expect that our results will also play a role in the analysis on more general singular spaces.

2000 Mathematics Subject Classification: 22A22, 47G30, 58H05, 58J22, 58J40

Keywords and Phrases: groupoid, continuous family groupoid, pseudodifferential operator, continuous representation, index theory, compact and Fredholm operators.

¹supported by a scholarship of the German Academic Exchange Service (DAAD) within the *Hochschulsonderprogramm III von Bund und Ländern*, and the Sonderforschungsbereich 478 *Geometrische Strukturen in der Mathematik* at the University of Münster.

²supported by an NSF Young Investigator Award DMS-9457859 and a Sloan Research Fellowship.

INTRODUCTION

For the proof of his measured index theorem for $C^{\infty,0}$ -foliations [3], Connes introduced pseudodifferential operators on the holonomy groupoid. Two closely related constructions of algebras of pseudodifferential operators for general differentiable groupoids were proposed in [28, 29]. Coming from microlocal analysis of pseudodifferential operators on manifolds with corners, a similar construction was suggested and used by Melrose [21], without mentioning groupoids explicitly. While the initial motivation for these constructions was completely different, eventually it was realized that they all can be used to formalize various constructions with pseudodifferential operators related to adiabatic limits, scattering or spectral problems, and index theoretical computations.

Recall that a groupoid is a small category in which every morphism is invertible. The domain map $d : \mathcal{G}^{(1)} \rightarrow M$ associates to a morphism $g : d(g) \rightarrow r(g)$ its domain $d(g)$, which is an object in M . This yields a decomposition of the set of morphisms

$$\mathcal{G}^{(1)} = \bigcup_{x \in M} d^{-1}(x).$$

The basic idea for a pseudodifferential calculus on groupoids is to consider families $(P_x)_{x \in M}$ of pseudodifferential operators on the “fibers” $\mathcal{G}_x := d^{-1}(x)$ that are equivariant with respect to the action of the groupoid induced by composing compatible morphisms. All that is needed for this construction is in fact a smooth structure on the sets \mathcal{G}_x , $x \in M$. Of course, there is a maze of possible ways to glue these fibers together. Let us only mention *differentiable groupoids*, where the fibers, roughly speaking, depend smoothly on the parameter $x \in M$, and *continuous family groupoids* introduced by Paterson [32] generalizing the holonomy groupoid of a $C^{\infty,0}$ -foliation as considered in [3]. In that case, the dependence on x is merely continuous in an appropriate sense – see Section 1 for precise definitions.

In [28, 29] pseudodifferential operators were introduced on differentiable groupoids; one of the main results is that (under appropriate restrictions on the distributional supports) pseudodifferential operators can be composed. Though the definition is rather simple, these algebras of pseudodifferential operators recover many previously known classes of operators, including families, adiabatic limits, and longitudinal operators on foliations. Moreover, for manifolds with corners, the pseudodifferential calculus identifies with a proper subalgebra of the “b”-calculus [18, 19]. It is possible, however, to recover the “b”-calculus in the framework of groupoids, as shown by the second autor in [27].

In this paper, we first extend the construction of [28, 29] to continuous family groupoids. This more general setting enables us to freely restrict pseudodifferential operators to invariant subsets of the groupoid; these restrictions are necessary to fully understand the Fredholm properties of pseudodifferential operators on groupoids. To see what are the technical problems when dealing with the more restrictive setting of differentiable groupoids, simply note that for instance, the boundary of a manifold with corners is not a manifold with

corners anymore, so that the class of differentiable groupoids is not stable under restriction to invariant subsets.

In the main part of the paper, we set up some analytical foundations for a general pseudodifferential analysis on groupoids. This covers among others the existence of bounded representations on appropriate Hilbert spaces, and criteria for Fredholmness or compactness. This is inspired in part by the central role played by groupoids in the work of Connes on index theory and by some questions in spectral theory [13]. In both cases it is natural to consider norm closures of the algebras of pseudodifferential operators that are of interest, so the study of these complete algebras plays a prominent role in our paper. We show that (and how) the geometry of the space of objects of a given groupoid is reflected by the structure of the C^* -algebra generated by the operators of order zero. The morphism of restricting to invariant subsets is an important tool in this picture; these homomorphisms are in fact necessary ingredients to understand Fredholm and representation theory of pseudodifferential operators. Let us now briefly describe the contents of each section. The first section introduces continuous family groupoids and explains how the results of [28] and [29] can be extended to this setting. However, we avoid repeating the same proofs.

In the second section, we discuss restriction maps, which are a generalization of the indicial maps of Melrose. The third section contains the basic results on the boundedness and representations of algebras of pseudodifferential operators on a continuous family groupoid. We prove that all boundedness results for pseudodifferential operators of order zero reduce to the corresponding results for regularizing operators. This is obtained using a variant of the approach of Hörmander [6]. In the fourth section, we study the structure of the norm closure of the groupoid algebras and obtain a canonical composition series of a groupoid algebra, if there is given an invariant stratification of the space of units. This generalizes a result from [22]. As a consequence of this structure theorem, we obtain characterizations of Fredholm and of compact operators in these algebras in Theorem 4:

- *An order zero operator between suitable L^2 -spaces is Fredholm if, and only if, it is elliptic (i.e., its principal symbol is invertible) and its restrictions to all strata of lower dimension are invertible as operators between certain natural Hilbert spaces.*
- *An order zero operator is compact if, and only if, its principal symbol and all its restrictions to strata of lower dimension vanish.*

See Theorem 4 for the precise statements. These characterizations of compactness and Fredholmness are classical results for compact manifolds without boundary (which correspond in our framework to the product groupoid $\mathcal{G} = M \times M$, M compact without boundary). For other classes of operators, characterizations of this kind were obtained previously for instance in [17, 19, 20, 22, 23, 33, 41].

The last section contains two applications. The first one is a discussion of the relation between the adiabatic groupoid \mathcal{G}_{ad} canonically associated to a groupoid \mathcal{G} and index theory of pseudodifferential operators. The second application is to operators on a covering \widetilde{M} of a manifold with boundary M , with group of deck transformations denoted by $\widetilde{\Gamma}$. We prove that every invariant, b -pseudodifferential, elliptic operator on \widetilde{M} has a perturbation by regularizing operators of the same kind that is C^* (Γ)-Fredholm in the sense of Mishenko and Fomenko. This was first proved in [14] using “spectral sections.”

A differentiable groupoid is a particular case of a continuous family groupoid. In particular, all results of this section remain valid for differentiable groupoids, when they make sense. This also allows us to recover most of the results of [12].

The dimension of the fibers \mathcal{G}_x is constant in x on each component of M . For simplicity, we agree throughout the paper to assume that M is connected and denote by n the common dimension of the fibers \mathcal{G}_x .

Acknowledgments: The first named author is indebted to Richard Melrose for explaining the conormal nature of pseudodifferential operators. He wants to thank the Massachusetts Institute of Technology and the SFB 478 at the University of Münster, and, in particular, Richard Melrose and Joachim Cuntz for the invitation and excellent hospitality. Also, we would like to thank an anonymous referee for comments that helped to improve parts of the manuscript.

1 BASIC DEFINITIONS

We begin this section by recalling some definitions involving groupoids. Then we review and extend some results from [28, 29] on pseudodifferential operators, from the case of differentiable groupoids to that of continuous family groupoids. In the following, we shall use the framework of [28, 29], and generalize it to the context of continuous family groupoids.

A *small category* is a category whose class of morphisms is a set. The class of objects of a small category is then a set as well. By definition, a *groupoid* is a small category \mathcal{G} in which every morphism is invertible. See [37] for general references on groupoids.

We now fix some notation and make the definition of a groupoid more explicit. The set of objects (or *units*) of \mathcal{G} is denoted by M or $\mathcal{G}^{(0)}$. The set of morphisms (or *arrows*) of a groupoid \mathcal{G} is denoted by $\mathcal{G}^{(1)}$. We shall sometimes write \mathcal{G} instead of $\mathcal{G}^{(1)}$, by abuse of notation. For example, when we consider a space of functions on \mathcal{G} , we actually mean a space of functions on $\mathcal{G}^{(1)}$. We will denote by $d(g)$ [respectively $r(g)$] the *domain* [respectively, the *range*] of the morphism $g : d(g) \rightarrow r(g)$. We thus obtain functions

$$d, r : \mathcal{G}^{(1)} \longrightarrow M = \mathcal{G}^{(0)} \quad (1)$$

that will play an important role in what follows. The multiplication gh of $g, h \in \mathcal{G}^{(1)}$ is defined if, and only if, $d(g) = r(h)$. A groupoid \mathcal{G} is completely

determined by the spaces M and \mathcal{G} and by the structural morphisms: d, r , multiplication, inversion, and the inclusion $M \rightarrow \mathcal{G}$.

In [3], A. Connes defined the notion of a $\mathcal{C}^{\infty,0}$ -foliation. This leads to the definition of a *continuous family groupoid* by Paterson [32]. Let us summarize this notion.

By definition, a *continuous family groupoid* is a locally compact topological groupoid such that \mathcal{G} is covered by some open subsets Ω and:

- each chart Ω is homeomorphic to two open subsets of $\mathbb{R}^k \times \mathcal{G}^{(0)}$, $T \times U$ and $T' \times U'$ such that the following diagram is commutative:

$$\begin{array}{ccccc}
 & T' \times U' & \xleftarrow{\cong} & \Omega & \xrightarrow{\cong} & T \times U \\
 & \swarrow & & \searrow & & \swarrow \\
 U' & \xleftarrow{=} & r(\Omega) & & d(\Omega) & \xrightarrow{=} & U
 \end{array}$$

- each coordinate change is given by $(t, u) \mapsto (\phi(t, u), u)$ where ϕ is of class $\mathcal{C}^{\infty,0}$, i.e. $u \mapsto \phi(\cdot, u)$ is a continuous map from U to $\mathcal{C}^{\infty}(T, T')$.

In addition, one requires that the composition and the inversion be $\mathcal{C}^{\infty,0}$ morphisms.

Generally, we will transform several concepts from the smooth to the $\mathcal{C}^{\infty,0}$ setting. The definitions are in the same spirit as the definition of a continuous family groupoid, and the reader can fill in the necessary details without any difficulties. For instance, the restriction $A(\mathcal{G})$ of the d -vertical tangent bundle $T_d\mathcal{G} = \bigcup_{g \in \mathcal{G}} T_g\mathcal{G}_{d(g)}$ of \mathcal{G} to the space of units is called the *Lie algebroid of \mathcal{G}* ; it is a $\mathcal{C}^{\infty,0}$ -vector bundle.

We now review pseudodifferential operators, the main focus being on the definition and properties of the algebra $\Psi^{\infty}(\mathcal{G})$ of pseudodifferential operators on a continuous family groupoid \mathcal{G} , and its variant, $\Psi^{\infty}(\mathcal{G}; E)$, the algebra of pseudodifferential operators on \mathcal{G} acting on sections of a vector bundle.

Consider a complex vector bundle E on the space of units M of a continuous family groupoid \mathcal{G} , and let $r^*(E)$ be its pull-back to \mathcal{G} . Right translations on \mathcal{G} define linear isomorphisms

$$U_g : \mathcal{C}^{\infty}(\mathcal{G}_{d(g)}, r^*(E)) \rightarrow \mathcal{C}^{\infty}(\mathcal{G}_{r(g)}, r^*(E)) : (U_g f)(g') = f(g'g) \in (r^*E)_{g'} \quad (2)$$

which are defined because $(r^*E)_{g'} = (r^*E)_{g'g} = E_{r(g')}$.

Let $B \subset \mathbb{R}^n$ be an open subset. Define the space $\mathcal{S}^m(B \times \mathbb{R}^n)$ of symbols on the bundle $B \times \mathbb{R}^n \rightarrow B$ as in [8] to be the set of smooth functions $a : B \times \mathbb{R}^n \rightarrow \mathbb{C}$ such that

$$|\partial_y^{\alpha} \partial_{\xi}^{\beta} a(y, \xi)| \leq C_{K, \alpha, \beta} (1 + |\xi|)^{m - |\beta|} \quad (3)$$

for any compact set $K \subset B$, for any multi-indices α and β , for any $x \in K$, and for any $\xi \in \mathbb{R}^n$. An element of one of our spaces \mathcal{S}^m should more properly be

said to have “order less than or equal to m ”; however, by abuse of language we will say that it has “order m .”

A symbol $a \in \mathcal{S}^m(B \times \mathbb{R}^n)$ is called *classical* (or polyhomogeneous) if it has an asymptotic expansion as an infinite sum of homogeneous symbols $a \sim \sum_{k=0}^{\infty} a_{m-k}$, a_l homogeneous of degree l :

$$a_l(y, t\xi) = t^l a_l(y, \xi) \quad \text{if } \|\xi\| \geq 1$$

and $t \geq 1$. (“Asymptotic expansion” is used here in the sense that for each $N \in \mathbb{N}$, the difference $a - \sum_{k=0}^{N-1} a_{m-k}$ belongs to $\mathcal{S}^{m-N}(B \times \mathbb{R}^n)$.) The space of classical symbols will be denoted by $\mathcal{S}_{\text{cl}}^m(B \times \mathbb{R}^n)$; its topology is given by the semi-norms induced by the inequalities (3). We shall be working exclusively with classical symbols in this paper.

This definition immediately extends to give spaces $\mathcal{S}_{\text{cl}}^m(E; F)$ of symbols on E with values in F , where $\pi : E \rightarrow B$ and $F \rightarrow B$ are smooth Euclidean vector bundles. These spaces, which are independent of the metrics used in their definition, are sometimes denoted $\mathcal{S}_{\text{cl}}^m(E; \pi^*(F))$. Taking $E = B \times \mathbb{R}^n$ and $F = \mathbb{C}$ one recovers $\mathcal{S}_{\text{cl}}^m(B \times \mathbb{R}^n) = \mathcal{S}_{\text{cl}}^m(B \times \mathbb{R}^n; \mathbb{C})$.

Recall that an operator $T : \mathcal{C}_c^\infty(U) \rightarrow \mathcal{C}^\infty(V)$ is called *regularizing* if, and only if, it has a smooth distribution (or Schwartz) kernel. For any open subset W of \mathbb{R}^n and any complex valued symbol a on $T^*W = W \times \mathbb{R}^n$, let

$$a(y, D_y) : \mathcal{C}_c^\infty(W) \rightarrow \mathcal{C}^\infty(W)$$

be given by

$$a(y, D_y)u(y) = (2\pi)^{-n} \int_{\mathbb{R}^n} e^{iy \cdot \xi} a(y, \xi) \hat{u}(\xi) d\xi. \quad (4)$$

Then, by definition, a pseudodifferential operator P on B is a continuous, linear map $P : \mathcal{C}_c^\infty(B) \rightarrow \mathcal{C}^\infty(B)$ that is locally of the form $P = a(y, D_y) + R$, where R is a regularizing operator.

We shall sometimes refer to pseudodifferential operators acting on a smooth manifold as *ordinary* pseudodifferential operators, in order to distinguish them from pseudodifferential operators on groupoids, a class of operators we now define (and which are really *families* of ordinary pseudodifferential operators). Throughout this paper, we shall denote by $(P_x, x \in M)$ a family of order m pseudodifferential operators P_x , acting on the spaces $\mathcal{C}_c^\infty(\mathcal{G}_x, r^*(E))$ for some vector bundle E over M . Operators between sections of two *different* vector bundles E_1 and E_2 are obtained by considering $E = E_1 \oplus E_2$. (See also below.)

DEFINITION 1 *A family $(P_x, x \in M)$ as above is called continuous if, and only if, for any open chart $V \subset \mathcal{G}$, homeomorphic to $W \times d(V)$, and for any $\phi \in \mathcal{C}_c^{\infty, 0}(V)$, we can find a continuous family of symbols $(a_x, x \in d(V))$ with*

$$a_x \in \mathcal{S}_{\text{cl}}^m(T^*W; \text{End}(E))$$

such that $\phi P_x \phi$ corresponds to $a_x(y, D_y)$ under the diffeomorphism $\mathcal{G}_x \cap V \simeq W$, for each $x \in d(V)$.

Thus, we require that the operators P_x be given in local coordinates by symbols a_x that depend smoothly on longitudinal variables (with respect to d) and continuously on transverse variables.

Let us denote by \mathcal{D} the density bundle of the Lie algebroid $A(\mathcal{G})$.

DEFINITION 2 *An order m , invariant pseudodifferential operator P on a continuous family groupoid \mathcal{G} , acting on sections of the vector bundle E , is a continuous family $(P_x, x \in M)$ of order m , classical pseudodifferential operators P_x acting on $\mathcal{C}_c^\infty(\mathcal{G}_x, r^*(E \otimes \mathcal{D}^{1/2}))$ that satisfies*

$$P_{r(g)}U_g = U_g P_{d(g)}, \quad (5)$$

for any $g \in \mathcal{G}$, where U_g is as in (2).

This definition is a generalization of the one in [28, 29]; moreover, we have replaced the bundle E by $E \otimes \mathcal{D}^{1/2}$.

Let us denote by $\mathcal{C}^{-\infty}(Y; E) := \mathcal{C}_c^\infty(Y, E' \otimes \Omega)'$ the space of distributions on a smooth manifold Y with coefficients in the bundle E ; here E' is the dual bundle of E , and $\Omega = \Omega(Y)$ is the bundle of 1-densities on Y .

We fix from now on a Hermitian metric on E , and we use it to identify E' , the dual of E , with \overline{E} , the complex conjugate of E . Of course, $\overline{\overline{E}} \simeq E$.

For a family of pseudodifferential operators $P = (P_x, x \in \mathcal{G}^{(0)})$ acting on \mathcal{G}_x , let us denote by K_x the distributional kernel of P_x

$$\begin{aligned} K_x &\in \mathcal{C}^{-\infty}(\mathcal{G}_x \times \mathcal{G}_x; r_1^*(E \otimes \mathcal{D}^{1/2}) \otimes r_2^*(E \otimes \mathcal{D}^{1/2})' \otimes \Omega_2) \\ &\simeq \mathcal{C}^{-\infty}(\mathcal{G}_x \times \mathcal{G}_x; r_1^*(E \otimes \mathcal{D}^{1/2}) \otimes r_2^*(E \otimes \mathcal{D}^{1/2})). \end{aligned} \quad (6)$$

Here Ω_2 is the pull-back of the bundle of vertical densities $r^*(\mathcal{D})$ on \mathcal{G}_x to $\mathcal{G}_x \times \mathcal{G}_x$ via the second projection. These distributional kernels are obtained using Schwartz' kernel theorem. Let us denote

$$\text{END}(E) := r^*(E \otimes \mathcal{D}^{1/2}) \otimes d^*(E^* \otimes \mathcal{D}^{1/2}).$$

The space of kernels of pseudodifferential operators on \mathcal{G}_x is denoted, as usual, by $I^m(\mathcal{G}_x \times \mathcal{G}_x, \mathcal{G}_x; \text{END}(E))$ where $\mathcal{G}_x \hookrightarrow \mathcal{G}_x \times \mathcal{G}_x$ is embedded as the diagonal [8].

Let $\mu_1(g', g) = g'g^{-1}$. We define the support of the operator P to be

$$\text{supp}(P) = \overline{\cup_x \mu_1(\text{supp}(K_x))} \subset \mathcal{G}. \quad (7)$$

The family $P = (P_x, x \in \mathcal{G}^{(0)})$ is called *uniformly supported* if, and only if, $\text{supp}(P)$ is a compact subset of $\mathcal{G}^{(1)}$. The composition PQ of two uniformly supported families of operators $P = (P_x, x \in M)$ and $Q = (Q_x, x \in M)$ on $\mathcal{G}^{(1)}$ is defined by pointwise multiplication:

$$PQ = (P_x Q_x, x \in M).$$

Since

$$\text{supp}(PQ) \subset \text{supp}(P) \text{supp}(Q),$$

the product is also uniformly supported. The action of a family $P = (P_x)$ on sections of $r^*(E)$ is also defined pointwise, as follows. For any smooth section $f \in \mathcal{C}^{\infty,0}(\mathcal{G}, r^*(E))$, let f_x be the restriction $f|_{\mathcal{G}_x}$. If each f_x has compact support and $P = (P_x, x \in \mathcal{G}^{(0)})$ is a family of ordinary pseudodifferential operators, then we define Pf such that its restrictions to the fibers \mathcal{G}_x are given by

$$(Pf)_x = P_x(f_x).$$

Let \mathcal{G} be a continuous family groupoid. The space of order m , invariant, *uniformly* supported pseudodifferential operators on \mathcal{G} , acting on sections of the vector bundle E will be denoted by $\Psi^{m,0}(\mathcal{G}; E)$. For the trivial bundle $E = M \times \mathbb{C}$, we write $\Psi^{m,0}(\mathcal{G}; E) = \Psi^{m,0}(\mathcal{G})$. Furthermore, let $\Psi^{\infty,0}(\mathcal{G}; E) = \cup_{m \in \mathbb{Z}} \Psi^{m,0}(\mathcal{G}; E)$ and $\Psi^{-\infty,0}(\mathcal{G}; E) = \cap_{m \in \mathbb{Z}} \Psi^{m,0}(\mathcal{G}; E)$.

Thus, $P \in \Psi^{m,0}(\mathcal{G}; E)$ is actually a continuous family $P = (P_x, x \in \mathcal{G}^{(0)})$ of ordinary pseudodifferential operators. It is sometimes more convenient to consider the convolution kernels of these operators. Let $K_x(g, g')$ be the Schwartz kernel of P_x , a distribution on $\mathcal{G}_x \times \mathcal{G}_x$, as above; thus $(K_x)_{x \in M}$ is a continuous family, equivariant with respect to the action of \mathcal{G} :

$$\forall g_0 \in \mathcal{G}, \forall g \in \mathcal{G}_{r(g_0)}, \forall g' \in \mathcal{G}_{d(g_0)}, K_{r(g_0)}(g, g'g_0^{-1}) = K_{d(g_0)}(gg_0, g').$$

We can therefore define

$$k_P(g) = K_{d(g)}(g, d(g)) \quad (8)$$

which is a distribution on \mathcal{G} , *i.e.* a continuous linear form on $\mathcal{C}^{\infty,0}(\mathcal{G})$.

We denote by $I_c^{m,0}(\mathcal{G}, M; \text{END}(E))$ the space of distributions k on \mathcal{G} such that for any $x \in \mathcal{G}$ the distribution defined by

$$K_x(g, g') := k(gg'^{-1})$$

is a pseudodifferential kernel on $\mathcal{G}_x \times \mathcal{G}_x$, *i.e.* $K_x \in I^m(\mathcal{G}_x \times \mathcal{G}_x, \mathcal{G}_x; \text{END}(E))$, and the family $(K_x)_{x \in M}$ is continuous. Let us denote by $\mathcal{S}_{\text{cl}}^{m,0}(A^*(\mathcal{G}); \text{END}(E))$ the space of continuous families $(a_x)_{x \in M}$ with $a_x \in \mathcal{S}_{\text{cl}}^m(T_x \mathcal{G}_x; \text{END}(E))$. For $P \in \Psi^{m,0}(\mathcal{G}; E)$, let

$$\sigma_m(P) \in \mathcal{S}_{\text{cl}}^{m,0}(A^*(\mathcal{G}); \text{END}(E)) / \mathcal{S}_{\text{cl}}^{m-1,0}(A^*(\mathcal{G}); \text{END}(E)) \quad (9)$$

be defined by

$$\sigma_m(P)(\xi) = \sigma_m(P_x)(\xi),$$

if $\xi \in A(\mathcal{G})_x$. Note that the principal symbol of P determines the principal symbols of the individual operators P_x by the invariance with respect to right translations. More precisely, we have $\sigma_m(P_x) = r^*(\sigma(P))|_{T^* \mathcal{G}_x}$. As in the classical situation, it is convenient to identify the space on the right hand side in (9)

with sections of a certain bundle \mathcal{P}_m . Let $S^*(\mathcal{G})$ be the cosphere bundle of \mathcal{G} , that is, $S^*(\mathcal{G}) = (A^*(\mathcal{G}) \setminus 0)/\mathbb{R}_+^*$ is the quotient of the vector bundle $A^*(\mathcal{G})$ with the zero section removed by the action of positive real numbers. Let \mathcal{P}_m be the bundle on $S^*(\mathcal{G})$ whose sections are $\mathcal{C}^{\infty,0}$ -functions f on $A^*(\mathcal{G}) \setminus 0$ that are homogeneous of degree m . Then the quotient space in Equation (9) can certainly be identified with the space $\mathcal{C}_c^{\infty,0}(S^*(\mathcal{G}), \text{End}(E) \otimes \mathcal{P}_m)$, thus, we have $\sigma_m(P) \in \mathcal{C}_c^{\infty,0}(S^*(\mathcal{G}), \text{End}(E) \otimes \mathcal{P}_m)$. The following theorem is a generalization of results from [26, 28, 29] and extends some well-known properties of the calculus of pseudodifferential operators on smooth manifolds.

THEOREM 1 *Let \mathcal{G} be a continuous family groupoid. Then*

$$\Psi^{m,0}(\mathcal{G}; E)\Psi^{m',0}(\mathcal{G}; E) \subset \Psi^{m+m',0}(\mathcal{G}; E),$$

$\sigma_{m+m'}(PQ) = \sigma_m(P)\sigma_{m'}(Q)$, and the map $P \mapsto k_P$ establishes an isomorphism $\Psi^{m,0}(\mathcal{G}; E) \ni P \mapsto k_P \in I_c^{m,0}(\mathcal{G}, M; \text{END}(E))$.

Moreover, the principal symbol σ_m gives rise to a short exact sequence

$$0 \rightarrow \Psi^{m-1,0}(\mathcal{G}; E) \rightarrow \Psi^{m,0}(\mathcal{G}; E) \xrightarrow{\sigma_m} \mathcal{C}_c^{\infty,0}(S^*(\mathcal{G}), \text{End}(E) \otimes \mathcal{P}_m) \rightarrow 0. \quad (10)$$

It follows that $\Psi^{-\infty,0}(\mathcal{G}; E)$ is a two-sided ideal of $\Psi^{\infty,0}(\mathcal{G}; E)$. Another consequence of the above theorem is that we obtain the asymptotic completeness of the spaces $\Psi^{m,0}(\mathcal{G})$: If $P_k \in \Psi^{m,0}(\mathcal{G})$ is a sequence of operators such that the order of $P_k - P_{k+1}$ converges to $-\infty$ and the kernels k_{P_k} have support contained in a fixed compact set, then there exists $P \in \Psi^{m,0}(\mathcal{G})$, such that the order of $P - P_k$ converges to $-\infty$.

Using an observation from [29], we can assume that E is the trivial one dimensional bundle $M \times \mathbb{C}$. Indeed, we can realize E as a sub-bundle of a trivial bundle $M \times \mathbb{C}^n$, with the induced metric. Let e be the orthogonal projection onto E , which is therefore an $n \times n$ matrix, and hence it is a multiplier of $\Psi^{\infty,0}(\mathcal{G})$. Then $\Psi^{m,0}(\mathcal{G}; E) \simeq eM_n(\Psi^{m,0}(\mathcal{G}))e$, for each m , and for $m = \infty$, it is an isomorphism of algebras. In the last section we shall consider operators between *different* vector bundles. They can be treated similarly, as follows. Suppose E_0 and E_1 are two vector bundles on M and (P_x) , $x \in M$, is a family of pseudodifferential operators $P_x \in \Psi^{m,0}(\mathcal{G}_x; r^*(E_0), r^*(E_1))$ satisfying the usual conditions: (P_x) is a continuous family of invariant, uniformly supported operators. The set of such operators will be denoted $\Psi^{m,0}(\mathcal{G}; E_0, E_1)$. It can be defined using the spaces $\Psi^{m,0}(\mathcal{G})$ by the following procedure. Choose embeddings of E_0 and E_1 into the trivial bundle \mathbb{C}^N such that E_i can be identified with the range of a projection $e_i \in M_N(\mathcal{C}^\infty(M))$. Then $\Psi^{m,0}(\mathcal{G}; E_0, E_1) \simeq e_1M_N(\Psi^{m,0}(\mathcal{G}))e_0$, as filtered vector spaces.

Sometimes it is convenient to get rid of the density bundles in the definition of various algebras associated to a continuous family groupoid. This can easily be achieved as follows. The bundle \mathcal{D} is trivial, but not canonically. Choose a positive, nowhere vanishing section ω of \mathcal{D} . Its pull-back, denoted $r^*(\omega)$, restricts to a nowhere vanishing density on each fiber \mathcal{G}_x , and hence defines

a smooth measure μ_x , with support \mathcal{G}_x . From the definition, we see that the measures μ_x are invariant with respect to right translations.

The choice of ω as above gives rise to an isomorphism

$$\Phi_\omega : \Psi^{-\infty,0}(\mathcal{G}) \rightarrow \mathcal{C}_c^{\infty,0}(\mathcal{G}),$$

such that the convolution product becomes

$$f_0 * f_1(g) = \int_{\mathcal{G}_x} f_0(gh^{-1})f_1(h)d\mu_x(h),$$

where $g, h \in \mathcal{G}$ and $x = d(g)$. If we change ω to $\phi^{-2}\omega$, then we get $\Phi_{\phi^{-2}\omega}(f)(g) = \phi(r(g))\Phi_\omega(f)(g)\phi(d(g))$, and μ_x changes to $(\phi \circ r)^{-1}\mu_x$. See Ramazan's thesis [36] for the question of the existence of Haar systems on groupoids.

2 RESTRICTION MAPS

Let $A \subset M$ and let $\mathcal{G}_A := d^{-1}(A) \cap r^{-1}(A)$. Then \mathcal{G}_A is a groupoid with units A , called the *reduction of \mathcal{G} to A* . An *invariant* subset $A \subset M$ is a subset such that $d(g) \in A$ implies $r(g) \in A$. Then $\mathcal{G}_A = d^{-1}(A) = r^{-1}(A)$.

In this section we establish some elementary properties of the *restriction map*

$$\mathcal{R}_Y : \Psi^{\infty,0}(\mathcal{G}) \rightarrow \Psi^{\infty,0}(\mathcal{G}_Y),$$

associated to a closed, invariant subset $Y \subset M$. Then we study the properties of these indicial maps. For algebras acting on sections of a smooth, hermitian bundle E on M , this morphism becomes

$$\mathcal{R}_Y : \Psi^\infty(\mathcal{G}; E) \rightarrow \Psi^{\infty,0}(\mathcal{G}_Y; E|_Y).$$

Then Y is the space of units of the reduction \mathcal{G}_Y and $d^{-1}(Y) = r^{-1}(Y)$ is the space of arrows of \mathcal{G}_Y , hence

$$\mathcal{G}_Y = (Y, d^{-1}(Y))$$

is a continuous family groupoid for the structural maps obtained by restricting the structural maps of \mathcal{G} to \mathcal{G}_Y . As before, we identify the groupoid \mathcal{G}_Y with its set of arrows $d^{-1}(Y)$.

Clearly, $\mathcal{G}_Y = d^{-1}(Y)$ is a disjoint union of d -fibers \mathcal{G}_x , so if $P = (P_x, x \in \mathcal{G}^{(0)})$ is a pseudodifferential operator on \mathcal{G} , we can restrict P to $d^{-1}(Y)$ and obtain

$$\mathcal{R}_Y(P) := (P_x, x \in Y),$$

which is a family of operators acting on the fibers of $d : \mathcal{G}_Y = d^{-1}(Y) \rightarrow Y$ and satisfies all the conditions necessary to define an element of $\Psi^{\infty,0}(\mathcal{G}_Y)$. This leads to a map

$$\mathcal{R}_Y = \mathcal{R}_{Y,M} : \Psi^{\infty,0}(\mathcal{G}) \rightarrow \Psi^{\infty,0}(\mathcal{G}_Y), \quad (11)$$

which is easily seen to be an algebra morphism.

If $Z \subset Y$ are two closed invariant subsets of M , we also obtain a map

$$\mathcal{R}_{Z,Y} : \Psi^{\infty,0}(\mathcal{G}_Y) \rightarrow \Psi^{\infty,0}(\mathcal{G}_Z), \quad (12)$$

defined analogously. The following proposition summarizes the properties of the maps \mathcal{R}_Y .

PROPOSITION 1 *Let $Y \subset M$ be a closed, invariant subset. Using the notation above, we have:*

- (i) *The convolution kernel $k_{\mathcal{R}_Y(P)}$ of $\mathcal{R}_Y(P)$ is the restriction of k_P to $d^{-1}(Y)$.*
- (ii) *The map \mathcal{R}_Y is an algebra morphism with $\mathcal{R}_Y(\Psi^{m,0}(\mathcal{G})) = \Psi^{m,0}(\mathcal{G}_Y)$ and*

$$\mathcal{C}_0(M \setminus Y)I_c^{m,0}(\mathcal{G}, M; \text{END}(E)) \subseteq \ker(\mathcal{R}_Y).$$

- (iii) *If $Z \subset Y$ is a closed invariant submanifold, then $\mathcal{R}_Z = \mathcal{R}_{Z,Y} \circ \mathcal{R}_Y$.*
- (iv) *If $P \in \Psi^{m,0}(\mathcal{G})$, then $\sigma_m(\mathcal{R}_Y(P)) = \sigma_m(P)$ on $S^*(\mathcal{G}_Y) = S^*(\mathcal{G})|_Y$.*

PROOF: The definition of k_P , equation (8), is compatible with restrictions, and hence (i) follows from the definitions.

The surjectivity of \mathcal{R}_Y follows from the fact that the restriction

$$I_c^{m,0}(\mathcal{G}, M) \rightarrow I_c^{m,0}(\mathcal{G}_Y, Y)$$

is surjective. Finally, (iii) and (iv) follow directly from the definitions. \square

Consider now an *open* invariant subset $\mathcal{O} \subset M$, instead of a *closed* invariant subset $Y \subset M$. Then we still can consider the reduction $\mathcal{G}_{\mathcal{O}} = (\mathcal{O}, d^{-1}(\mathcal{O}))$, which is also a continuous family groupoid, and hence we can define $\Psi^{\infty,0}(\mathcal{G}_{\mathcal{O}})$. If moreover \mathcal{O} is the complement of a closed invariant subset $Y \subset M$, then we can extend a family $(P_x) \in \Psi^{\infty,0}(\mathcal{G}_{\mathcal{O}})$ to be zero outside \mathcal{O} , which gives an inclusion $\Psi^{\infty,0}(\mathcal{G}_{\mathcal{O}}) \subset \Psi^{\infty,0}(\mathcal{G})$. Clearly, $\Psi^{\infty,0}(\mathcal{G}_{\mathcal{O}}) \subset \ker(\mathcal{R}_Y)$, but they are not equal in general, although we shall see later on that the norm closures of these algebras are the same.

3 CONTINUOUS REPRESENTATIONS

As in the classical case of pseudodifferential operators on a compact manifold (without corners) M , the algebra $\Psi^{0,0}(\mathcal{G})$ of operators of order 0 acts by bounded operators on various Hilbert spaces. It is convenient, in what follows, to regard these actions from the point of view of representation theory. Unlike the classical case, however, there are many (non-equivalent, irreducible, bounded, and infinite dimensional) representations of the algebra $\Psi^{0,0}(\mathcal{G})$, in general. The purpose of this section is to introduce the class of representations in which we are interested and to study some of their properties. A consequence of our results is that in order to construct and classify bounded representations of $\Psi^{0,0}(\mathcal{G})$, it is essentially enough to do this for $\Psi^{-\infty,0}(\mathcal{G})$.

Let $\mathcal{D}^{1/2}$ be the square root of the density bundle

$$\mathcal{D} = |\wedge^n A(\mathcal{G})|,$$

as before. If $P \in \Psi^{m,0}(\mathcal{G})$ consists of the family $(P_x, x \in M)$, then each P_x acts on

$$V_x = C_c^\infty(\mathcal{G}_x; r^*(\mathcal{D}^{1/2})).$$

Since $r^*(\mathcal{D}^{1/2}) = \Omega_{\mathcal{G}_x}^{1/2}$ is the bundle of half densities on \mathcal{G}_x , we can define a hermitian inner product on V_x , and hence also the formal adjoint P_x^* of P_x . The following lemma establishes that $\Psi^{\infty,0}(\mathcal{G})$ is stable with respect to taking (formal) adjoints. (The formal adjoint P^* of a pseudodifferential operator P is the pseudodifferential operator that satisfies $(P^*\phi, \psi) = (\phi, P\psi)$, for all *compactly supported*, smooth 1/2-densities ϕ and ψ .) Let

$$\text{END}(\mathcal{D}^{1/2}) := r^*(\mathcal{D}^{1/2}) \otimes d^*(\mathcal{D}^{1/2}).$$

LEMMA 1 *If $P = (P_x, x \in M) \in \Psi^{m,0}(\mathcal{G})$, then $(P_x^*, x \in M) \in \Psi^{m,0}(\mathcal{G})$. Moreover,*

$$k_{P^*}(g) = \overline{k_P}(g^{-1}) \in I_c^{\infty,0}(\mathcal{G}, M; \text{END}(\mathcal{D}^{1/2})), \tag{13}$$

and hence $\sigma_m(P^*) = \overline{\sigma_m(P)}$.

PROOF: It follows directly from the invariance of the family P_x that the family P_x^* is invariant. The support $\text{supp}(P^*) = \text{supp}(k_{P^*}) \subset \mathcal{G}$ of the reduced kernel k_{P^*} is $\iota(\text{supp}(P)) = \{g^{-1}, g \in \text{supp}(P)\}$, also a compact set. Since the adjoint of a continuous family is a continuous family, we obtain that $(P_x^*)_{x \in M}$ defines an element of $\Psi^{m,0}(\mathcal{G})$.

We now obtain the explicit formula (13) for the kernel of k_{P^*} stated above. Suppose first that $P \in \Psi^{-n-1,0}(\mathcal{G})$. Then the convolution kernel k_P of P is a compactly supported continuous section of $\text{END}(\mathcal{D}^{1/2})$, and the desired formula follows by direct computation. In general, we can choose $P_m \in \Psi^{-n-1,0}(\mathcal{G})$ such that $k_{P_m} \rightarrow k_P$ as distributions. Then $k_{P_m^*} \rightarrow k_{P^*}$ as distributions also, which gives (13) in general. □

Having defined the involution $*$ on $\Psi^{\infty,0}(\mathcal{G})$, we can now introduce the representations we are interested in. Fix $m \in \{0\} \cup \{\pm\infty\}$ and let \mathcal{H}_0 be a dense subspace of a Hilbert space.

DEFINITION 3 *A bounded $*$ -representation of $\Psi^{m,0}(\mathcal{G})$ on the inner product space \mathcal{H}_0 is a morphism $\rho : \Psi^{m,0}(\mathcal{G}) \rightarrow \text{End}(\mathcal{H}_0)$ satisfying*

$$(\rho(P^*)\xi, \eta) = (\xi, \rho(P)\eta) \tag{14}$$

and, if $P \in \Psi^{0,0}(\mathcal{G})$,

$$\|\rho(P)\xi\| \leq C_P \|\xi\|, \tag{15}$$

for all $\xi, \eta \in \mathcal{H}_0$, where $C_P > 0$ is independent of ξ . One defines similarly bounded $*$ -representations of the algebras $\Psi^{m,0}(\mathcal{G}; E)$.

Note that for $m > 0$ and $P \in \Psi^{m,0}(\mathcal{G})$, $\rho(P)$ does not have to be bounded, even if ρ is bounded. However, $\rho(P)$ will be a densely defined operator with $\rho(P^*) \subset \rho(P)^*$.

THEOREM 2 *Let \mathcal{H} be a Hilbert space and let $\rho : \Psi^{-\infty,0}(\mathcal{G}; E) \rightarrow \text{End}(\mathcal{H})$ be a bounded $*$ -representation. Then ρ extends to a bounded $*$ -representation of $\Psi^{0,0}(\mathcal{G}; E)$ on \mathcal{H} and to a bounded $*$ -representation of $\Psi^{\infty,0}(\mathcal{G}; E)$ on the subspace $\mathcal{H}_0 := \rho(\Psi^{-\infty,0}(\mathcal{G}; E))\mathcal{H}$ of \mathcal{H} . Moreover, any extension of ρ to a $*$ -representation of $\Psi^{0,0}(\mathcal{G}; E)$ is bounded and is uniquely determined provided that \mathcal{H}_0 is dense in \mathcal{H} .*

PROOF: We assume that $E = \mathbb{C}$ is a trivial line bundle, for simplicity. The general case can be treated in exactly the same way. We first address the question of the existence of the extension ρ with the desired properties. Let $P \in \Psi^{m,0}(\mathcal{G})$. If \mathcal{H}_0 is not dense in \mathcal{H} , we let $\rho(P) = 0$ on the orthogonal complement of \mathcal{H}_0 . Thus, in order to define $\rho(P)$, we may assume that \mathcal{H}_0 is dense in \mathcal{H} .

On \mathcal{H}_0 we let

$$\rho(P)\xi = \rho(PQ)\eta,$$

if $\xi = \rho(Q)\eta$, for some $Q \in \Psi^{-\infty,0}(\mathcal{G})$ and $\eta \in \mathcal{H}$; however, we need to show that this is well-defined and that it gives rise to a bounded operator for each $P \in \Psi^{0,0}(\mathcal{G})$. Thus, we need to prove that $\sum_{k=1}^N \rho(PQ_k)\xi_k = 0$, if $P \in \Psi^{0,0}(\mathcal{G})$ and $\sum_{k=1}^N \rho(Q_k)\xi_k = 0$, for some $Q_k \in \Psi^{-\infty,0}(\mathcal{G})$ and $\xi_k \in \mathcal{H}$.

We will show that, for each $P \in \Psi^{0,0}(\mathcal{G})$, there exists a constant $C_P > 0$ such that

$$\left\| \sum_{k=1}^N \rho(PQ_k)\xi_k \right\| \leq C_P \left\| \sum_{k=1}^N \rho(Q_k)\xi_k \right\|. \quad (16)$$

This will prove that $\rho(P)$ is well defined and bounded at the same time. To this end, we use an argument of [8]. Let $M \geq |\sigma_0(P)| + 1$, $M \in \mathbb{R}$, and let

$$b = (M^2 - |\sigma_0(P)|^2)^{1/2}. \quad (17)$$

Then $b - M$ is in $\mathcal{C}_c^{\infty,0}(S^*(\mathcal{G}))$, and it follows from Theorem 1 that we can find $Q_0 \in \Psi^{0,0}(\mathcal{G})$ such that $\sigma_0(Q_0) = b - M$. Let $Q = Q_0 + M$. Using again Theorem 1, we obtain, for

$$R = M^2 - P^*P - Q^*Q \in \Psi^{0,0}(\mathcal{G}),$$

that

$$\sigma_0(R) = \sigma_0(M^2 - P^*P - Q^*Q) = 0,$$

and hence $R \in \Psi^{-1,0}(\mathcal{G})$. We can also assume that Q is self-adjoint. We claim that we can choose Q so that R is of order $-\infty$. Indeed, by the asymptotic completeness of the space of pseudodifferential operators, it is enough to find Q such that R is of arbitrary low order and has principal symbol in a fixed

compact set. So, assume that we have found Q such that R has order $-m$. Then, if we let $Q_1 = Q + (RS + SR)/4$, where S is a self-adjoint parametrix of Q (i.e., $SQ - 1$ and $QS - 1$ have negative order), then $R_1 = M^2 - P^*P - Q_1^2$ has lower order.

So, assume that R has order $-\infty$, and let

$$\xi = \sum_{k=1}^N \rho(Q_k)\xi_k, \quad \eta = \sum_{k=1}^N \rho(PQ_k)\xi_k, \quad \text{and} \quad \zeta = \sum_{k=1}^N \rho(Q_kQ_k)\xi_k. \quad (18)$$

Then we have

$$\begin{aligned} & (\eta, \eta) \\ &= \sum_{j,k=1}^N (\rho(Q_k^*P^*PQ_j)\xi_j, \xi_k) \\ &= \sum_{j,k=1}^N (M^2(\rho(Q_kQ_j)\xi_j, \xi_k) - (\rho(Q_k^*Q^*Q_j)\xi_j, \xi_k) - (\rho(Q_k^*RQ_j)\xi_j, \xi_k)) \\ &= M^2\|\xi\|^2 - \|\zeta\|^2 - (\rho(R)\xi, \xi) \leq (M^2 + \|\rho(R)\|)\|\xi\|^2. \end{aligned} \quad (19)$$

The desired representation of $\Psi^{0,0}(\mathcal{G})$ on \mathcal{H} is obtained by extending $\rho(P)$ by continuity to \mathcal{H} .

To extend ρ further to $\Psi^{\infty,0}(\mathcal{G})$, we proceed similarly: we want

$$\rho(P)\rho(Q)\xi = \rho(PQ)\xi,$$

for $P \in \Psi^{\infty,0}(\mathcal{G})$ and $Q \in \Psi^{-\infty,0}(\mathcal{G})$. Let ξ and η be as in Equation (18). We need to prove that $\eta = 0$ if $\xi = 0$. Now, because \mathcal{H}_0 is dense in \mathcal{H} , we can find T_j in A_ρ the norm closure of $\rho(\Psi^{-\infty,0}(\mathcal{G}))$ and $\eta_j \in \mathcal{H}$ such that $\eta = \sum_{j=1}^N T_j\eta_j$. Choose an approximate unit u_α of the C^* -algebra A_ρ , then $u_\alpha T_j \rightarrow T_j$ (in the sense of generalized sequences). We can replace then the generalized sequence (net) u_α by a subsequence, call it u_m such that $u_m T_j \rightarrow T_j$, as $m \rightarrow \infty$. By density, we may assume $u_m = \rho(R_m)$, for some $R_m \in \Psi^{-\infty,0}(\mathcal{G})$. Consequently, $\rho(R_m)\eta \rightarrow \eta$, as $m \rightarrow \infty$. Then

$$\eta = \lim \sum_{k=1}^N \rho(R_m)\rho(PQ_k)\xi_k = \lim \sum_{k=1}^N \rho(R_mP)\rho(Q_k)\xi_k = 0,$$

because $R_mP \in \Psi^{-\infty,0}(\mathcal{G})$.

We now consider the uniqueness of the extension of ρ to $\Psi^{0,0}(\mathcal{G})$. First, the uniqueness of this extension acting on the closure of $\mathcal{H}_0 = \rho(\Psi^{-\infty,0}(\mathcal{G}))\mathcal{H}$ is immediate. This implies the boundedness of any extension of ρ to $\Psi^{0,0}(\mathcal{G})$ if \mathcal{H}_0 is dense.

In general, a completely similar argument applies to give that on the orthogonal complement of \mathcal{H}_0 any extension of ρ to $\Psi^{0,0}(\mathcal{G})$ factors through a representation of $\Psi^{0,0}(\mathcal{G})/\Psi^{-1,0}(\mathcal{G})$, and hence it is again bounded. \square

Let $x \in M$, then the *regular representation* π_x associated to x is the natural representation of $\Psi^{\infty,0}(\mathcal{G})$ on $C_c^\infty(\mathcal{G}_x; r^*(\mathcal{D}^{1/2}))$, that is $\pi_x(P) = P_x$. (Because $C_c^\infty(\mathcal{G}_x; r^*(\mathcal{D}^{1/2}))$ consists of half-densities, it has a natural inner product and a natural Hilbert space completion.) As for locally compact groups, the regular representation(s) will play an important role in our study and are one of the main sources of examples of bounded $*$ -representations.

Assume that M is connected, so that all the manifolds \mathcal{G}_x have the same dimension n . We now proceed to define a Banach norm on $\Psi^{-n-1,0}(\mathcal{G})$. This norm depends on the choice of a trivialization of the bundle of densities \mathcal{D} , which then gives rise to a right invariant system of measures μ_x on \mathcal{G}_x . Indeed, for $P \in \Psi^{-n-1,0}(\mathcal{G})$, we use the chosen trivialization of \mathcal{D} to identify k_P , which is a priori a continuous family of distributions, with a compactly supported, $C^{\infty,0}$ -function on \mathcal{G} , still denoted k_P . We then define

$$\|P\|_1 = \sup_{x \in M} \left\{ \int_{\mathcal{G}_x} |k_P(g^{-1})| d\mu_x(g), \int_{\mathcal{G}_x} |k_P(g)| d\mu_x(g) \right\}. \quad (20)$$

If we change the trivialization of \mathcal{D} , then we obtain a new norm $\|P\|'_1$, which is however related to the original norm by $\|P\|'_1 = \|\phi P \phi^{-1}\|_1$, for some continuous function $\phi > 0$ on M . This shows that the completions of $\Psi^{-n-1,0}(\mathcal{G})$ with respect to $\|\cdot\|_1$ and $\|\cdot\|'_1$ are isomorphic.

COROLLARY 1 *Let $x \in M$. Then the regular representation π_x is a bounded $*$ -representation of $\Psi^{0,0}(\mathcal{G})$ such that $\|\pi_x(P)\| \leq \|P\|_1$, if $P \in \Psi^{-n-1,0}(\mathcal{G})$.*

PROOF: Suppose first that $P \in \Psi^{-n-1,0}(\mathcal{G})$. Then the convolution kernel k_P of P , which is a priori a distribution, turns out in this case to be a compactly supported continuous section of

$$\text{END}(\mathcal{D}^{1/2}) = r^*(\mathcal{D}^{1/2}) \otimes d^*(\mathcal{D}^{1/2}).$$

Choose a trivialization of \mathcal{D} , which then gives trivializations of $d^*(\mathcal{D})$ and $r^*(\mathcal{D})$. Also denote by μ_x the smooth measure on \mathcal{G}_x obtained from the trivialization of $\Omega_{\mathcal{G}_x} = r^*(\mathcal{D})$, so that $L^2(\mathcal{G}_x, r^*(\mathcal{D}^{1/2}))$ identifies with $L^2(\mathcal{G}_x, \mu_x)$. Using the same trivialization, we identify k_P with a continuous, compactly supported function.

The action of P_x on $C_c^\infty(\mathcal{G}_x)$ is given then by

$$P_x u(g) = \int_{\mathcal{G}_x} k_P(gh^{-1}) u(h) d\mu_x(h).$$

Let $y = r(g)$, $x = d(g) = d(h)$, and $z = r(h)$. Then the integrals

$$\int_{\mathcal{G}_x} |k_P(gh^{-1})| d\mu_x(h) = \int_{\mathcal{G}_y} |k_P(h^{-1})| d\mu_y(h),$$

and

$$\int_{\mathcal{G}_x} |k_P(gh^{-1})| d\mu_x(g) = \int_{\mathcal{G}_z} |k_P(g)| d\mu_z(g),$$

are uniformly bounded by a constant M that depends only on k_P and the trivialization of \mathcal{D} , but not on $g \in \mathcal{G}_x$ or $h \in \mathcal{G}_x$. A well-known estimate implies then that P_x is bounded on $L^2(\mathcal{G}_x, \mu_x)$ with

$$\|\pi_x(P)\| = \|P_x\| \leq M.$$

Then Theorem 2 gives the result. \square

Note that the boundedness of order zero operators depends essentially on the fact that we use *uniformly supported* operators. For properly supported operators this is not true, as seen by considering the multiplication operator with an unbounded function $f \in \mathcal{C}(M)$.

Define now the *reduced norm* of P by

$$\|P\|_r = \sup_x \|\pi_x(P)\| = \sup_x \|P_x\|, \quad x \in M.$$

Then $\|P\|_r$ is the norm of the operator $\pi(P) := \prod \pi_x(P)$ acting on the Hilbert space direct sum

$$l^2 - \bigoplus_{x \in M} L^2(\mathcal{G}_x).$$

The Hilbert space l^2 -direct sum space $l^2 - \bigoplus_{x \in M} L^2(\mathcal{G}_x)$ is called the space of the *total regular* representation. Also, let

$$\|P\| = \sup_{\rho} \|\rho(P)\|,$$

where ρ ranges through all bounded $*$ -representations ρ of $\Psi^{0,0}(\mathcal{G})$ such that

$$\|\rho(P)\| \leq \|P\|_1,$$

for all $P \in \Psi^{-\infty,0}(\mathcal{G})$ and for some fixed choice of the measures μ_x corresponding to a trivialization of \mathcal{D} .

The following result shows, in particular, that we have $\|P\|_r \leq \|P\| < \infty$, for all $P \in \Psi^{0,0}(\mathcal{G})$, which is not clear a priori from the definition.

COROLLARY 2 *Let $P \in \Psi^{0,0}(\mathcal{G})$, then $\|P\|$ and $\|P\|_r$ are finite and we have the inequalities $\|\mathcal{R}_Y(P)\|_r \leq \|P\|_r$ and $\|\mathcal{R}_Y(P)\| \leq \|P\|$, for any closed invariant submanifold Y of M .*

PROOF: Consider the product representation $\pi = \prod_{x \in M} \pi_x$ of $\Psi^{-\infty,0}(\mathcal{G})$ acting on

$$\mathcal{H} := \prod L^2(\mathcal{G}_x; \mathcal{D}^{1/2}).$$

It follows from Corollary 1 that π is bounded. By Theorem 2, π is bounded on $\Psi^{0,0}(\mathcal{G})$. This shows that $\|P\|_r := \|\pi(P)\|$ is finite for all $P \in \Psi^{0,0}(\mathcal{G})$.

Moreover, we have

$$\|\mathcal{R}_Y(P)\|_r = \sup_{y \in Y} \|\pi_y(P)\| \leq \sup_{x \in M} \|\pi_x(P)\| = \|P\|_r.$$

The rest is proved similarly. \square

Denote by $\mathfrak{A}(\mathcal{G})$ [respectively, by $\mathfrak{A}_r(\mathcal{G})$] the closure of $\Psi^{0,0}(\mathcal{G})$ in the norm $\|\cdot\|$ [respectively, in the norm $\|\cdot\|_r$]. Also, denote by $C^*(\mathcal{G})$ [respectively, by $C_r^*(\mathcal{G})$] the closure of $\Psi^{-\infty,0}(\mathcal{G})$ in the norm $\|\cdot\|$ [respectively, in the norm $\|\cdot\|_r$].

We also obtain an extension of the classical results on the boundedness of the principal symbol and of results on the distance of an operator to the regularizing ideal. In what follows, $S^*(\mathcal{G})$ denotes the space of rays in $A^*(\mathcal{G})$, as in Section 1. By choosing a metric on $A(\mathcal{G})$, we may identify $S^*(\mathcal{G})$ with the subset of vectors of length one in $A^*(\mathcal{G})$.

COROLLARY 3 *Let $P \in \Psi^{0,0}(\mathcal{G})$. Then the distance from P to $C_r^*(\mathcal{G})$ in $\mathfrak{A}(\mathcal{G})$ is $\|\sigma_0(P)\|_\infty$. Similarly, $\text{dist}(P, C^*(\mathcal{G})) = \|\sigma_0(P)\|_\infty$, for all $P \in \Psi^{0,0}(\mathcal{G})$. Consequently, the principal symbol extends to continuous algebra morphisms $\mathfrak{A}_r(\mathcal{G}) \rightarrow \mathcal{C}_0(S^*(\mathcal{G}))$ and $\mathfrak{A}(\mathcal{G}) \rightarrow \mathcal{C}_0(S^*(\mathcal{G}))$ with kernels $C_r^*(\mathcal{G})$ and $C^*(\mathcal{G})$, respectively.*

PROOF: Let $P = (P_x)$. Then, by classical results,

$$\|\sigma_0(P)\|_\infty = \sup_{x \in M} \|\sigma_0(P_x)\|_\infty \leq \sup_{x \in M} \|P_x\| = \|P\|_r \leq \|P\|.$$

This proves the first part of this corollary.

Consider now the morphism $\rho : \Psi^{0,0}(\mathcal{G}) \rightarrow \mathfrak{A}_r(\mathcal{G})/C_r^*(\mathcal{G})$. Then we proceed as in the proof of Theorem 2, but we take $M = \|\sigma_0(P)\|_\infty + \epsilon$ in the definition of b of Equation (17), where $\epsilon > 0$ is small but fixed. Since we may assume that $\mathfrak{A}_r(\mathcal{G})/C_r^*(\mathcal{G})$ is embedded in the algebra of bounded operators on a Hilbert space, we may apply the same argument as in the proof of Theorem 2, and construct $Q \in \Psi^{0,0}(\mathcal{G}) + \mathcal{C}1$ and $R \in \Psi^{-\infty,0}(\mathcal{G})$ such that $P^*P = M^2 - Q^*Q - R$. Then Equation (19) gives $\|\rho(P)\| \leq M$, because ρ vanishes on $\Psi^{-\infty,0}(\mathcal{G})$. \square

We shall continue to denote by σ_0 the extensions by continuity of the principal symbol map $\sigma_0 : \Psi^{0,0}(\mathcal{G}) \rightarrow \mathcal{C}_c^{\infty,0}(S^*(\mathcal{G}))$. The above corollary extends to operators acting on sections of a vector bundle E , in an obvious way.

See [28] for a result related to Corollary 3. Another useful consequence is the following.

COROLLARY 4 *Using the above notation, we have that $\Psi^{-\infty,0}(\mathcal{G})$ is dense in $\Psi^{-1,0}(\mathcal{G})$ in the $\|\cdot\|$ -norm, and hence $\Psi^{-1,0}(\mathcal{G}) \subset C^*(\mathcal{G})$ and $\Psi^{-1,0}(\mathcal{G}) \subset C_r^*(\mathcal{G})$.*

4 INVARIANT FILTRATIONS

Let \mathcal{G} be a continuous family groupoid with space of units denoted by M . In order to obtain more insight into the structure of the algebras $\mathfrak{A}(\mathcal{G})$ and $\mathfrak{A}_r(\mathcal{G})$, we shall make certain assumptions on \mathcal{G} .

DEFINITION 4 *An invariant filtration $Y_0 \subset Y_1 \subset \dots \subset Y_n = M$ is an increasing sequence of closed invariant subsets of M .*

Fix now an invariant filtration $Y_0 \subset Y_1 \subset \dots \subset Y_n = M$. For each k , we have restriction maps \mathcal{R}_{Y_k} and we define ideals \mathfrak{I}_k as follows:

$$\mathfrak{I}_k = \ker \mathcal{R}_{Y_{k-1}} \cap C^*(\mathcal{G}). \quad (21)$$

(by convention, we define $\mathfrak{I}_0 = C^*(\mathcal{G})$).

We shall also consider the “ L^1 -algebra” $L^1(\mathcal{G})$ associated to a groupoid \mathcal{G} ; it is obtained as the completion of $\Psi^{-\infty,0}(\mathcal{G}) \simeq \mathcal{C}_c^{\infty,0}(\mathcal{G})$ (using a trivialization of the density bundle \mathcal{D}) in the $\|\cdot\|_1$ -norm, defined in Equation (20). More precisely, $L^1(\mathcal{G})$ is the completion of $\mathcal{C}_c^{\infty,0}(\mathcal{G})$ in the algebra of bounded operators on

$$\ell^\infty - \bigoplus (L^1(\mathcal{G}_x) \oplus L^\infty(\mathcal{G}_x)),$$

so it is indeed an algebra. If $Y \subset M$ is invariant, then we obtain sequences

$$0 \rightarrow L^1(\mathcal{G}_{M \setminus Y}) \rightarrow L^1(\mathcal{G}) \rightarrow L^1(\mathcal{G}_Y) \rightarrow 0, \quad (22)$$

and

$$0 \rightarrow C^*(\mathcal{G}_{M \setminus Y}) \rightarrow C^*(\mathcal{G}) \rightarrow C^*(\mathcal{G}_Y) \rightarrow 0. \quad (23)$$

LEMMA 2 *The sequences (22) and (23) are exact.*

PROOF: The exactness of (22) follows from the fact that the two functions,

$$x \mapsto \int_{\mathcal{G}_x} |f(g)| d\mu_x(g) \quad \text{and} \quad x \mapsto \int_{\mathcal{G}_x} |f(g^{-1})| d\mu_x(g),$$

are continuous in x for $f \in L^1(\mathcal{G})$.

Indeed, to prove exactness in (22), let $f \in L^1(\mathcal{G})$ be a function that vanishes in $L^1(\mathcal{G}_Y)$. Then we can find $\phi_n \in \mathcal{C}_c^\infty(M \setminus Y)$ such that $\|f - \phi_n f\|_1 < 1/n$, by the continuity of the above two functions. Choose $f_n \in \mathcal{C}_c^{\infty,0}(\mathcal{G})$ such that $\|f_n - f\|_1 \rightarrow 0$, as $n \rightarrow \infty$. Then $\phi_n f_n \in \mathcal{C}_c^{\infty,0}(\mathcal{G}_{M \setminus Y})$ and $\|\phi_n f_n - f\|_1 \rightarrow 0$, as $n \rightarrow \infty$.

Let π be an irreducible representation of $C^*(\mathcal{G})$ that vanishes on $C^*(\mathcal{G}_{M \setminus Y})$. To prove the exactness of (23), it is enough to prove that π comes from a representation of $C^*(\mathcal{G}_Y)$. Now π vanishes on $L^1(\mathcal{G}_{M \setminus Y})$, and hence it induces a bounded $*$ -representation of $L^1(\mathcal{G}_Y)$, by the exactness of (22). This proves the exactness of (23). \square

The exactness of the second exact sequence was proved in [37], and is true in general for locally compact groupoids. It is worthwhile mentioning that the corresponding results for reduced C^* -algebras is not true (at least in the general setting of locally compact groupoids).

We then have the following generalization of some results from [9, 22, 26]:

THEOREM 3 *Let \mathcal{G} be a continuous family groupoid with space of units M and $Y_0 \subset Y_1 \subset \dots \subset Y_n = M$ be an invariant filtration. Then Equation (21) defines a composition series*

$$(0) \subset \mathfrak{I}_n \subset \mathfrak{I}_{n-1} \subset \dots \subset \mathfrak{I}_0 \subset \mathfrak{A}(\mathcal{G}),$$

with not necessarily distinct ideals, such that \mathfrak{I}_0 is the norm closure of $\Psi^{-\infty,0}(\mathcal{G})$ and \mathfrak{I}_k is the norm closure of $\Psi^{-\infty,0}(\mathcal{G}_{M \setminus Y_{k-1}})$. The subquotients are determined by $\sigma_0 : \mathfrak{A}_M / \mathfrak{I}_0 \xrightarrow{\sim} C_0(S^*(\mathcal{G}))$, and by

$$\mathfrak{I}_k / \mathfrak{I}_{k+1} \simeq C^*(\mathcal{G}_{Y_k \setminus Y_{k-1}}), \quad 0 \leq k \leq n.$$

The above theorem extends right away to operators acting on sections of a vector bundle E , the proof being exactly the same.

PROOF: We have that \mathfrak{I}_0 is the closure of $\Psi^{-\infty,0}(\mathcal{G})$, by definition. By the Corollaries 3 and 4, \mathfrak{I}_0 is also the kernel of σ_0 .

The rest of the theorem follows by applying Lemma 2 to the groupoids $\mathcal{G}_{M \setminus Y_{k-1}}$ and the closed subsets $Y_k \setminus Y_{k-1}$ of $M \setminus Y_{k-1}$, for all k . \square

The above theorem leads to a characterization of compactness and Fredholmness for operators in $\Psi^{0,0}(\mathcal{G})$, a question that was discussed also in [12, 26]. This generalizes the characterization of Fredholm operators in the “ b -calculus” or one of its variants on manifolds with corners, see [19, 23]. Characterizations of compact and of Fredholm operators on manifolds with more complicated boundaries were obtained in [11, 17], see also [41].

Recall that the *product groupoid* with units X is the groupoid with set of arrows $X \times X$, so there exists exactly one arrow between any two points of X , and we have $(x, y)(y, z) = (x, z)$.

THEOREM 4 *Suppose that, using the notation of the above theorem, the restriction of \mathcal{G} to $M \setminus Y_{n-1}$ is the product groupoid, and that the regular representation π_x is injective on $\mathfrak{A}(\mathcal{G})$ (for one, and hence for all $x \in M \setminus Y_{n-1}$).*

(i) *The algebra $\mathfrak{A}(\mathcal{G})$ contains (an ideal isomorphic to) the algebra of compact operators acting on $L^2(M \setminus Y_{n-1})$, where on $M \setminus Y_{n-1}$ we consider the (complete) metric induced by a metric on $A(\mathcal{G})$.*

(ii) *An operator $P \in \Psi^{0,0}(\mathcal{G})$ is compact on $L^2(M \setminus Y_{n-1})$ if, and only if, the principal symbol $\sigma_0(P)$ vanishes, and $\mathcal{R}_{Y_{n-1}}(P) = 0 \in \Psi^{0,0}(\mathcal{G}_{Y_{n-1}})$.*

(iii) *An operator $P \in \mathfrak{A}(\mathcal{G})$ is Fredholm on $L^2(M \setminus Y_{n-1})$ if, and only if, $\sigma_0(P)(\xi)$ is invertible for all $\xi \in S^*(\mathcal{G})$ (which can happen only when M is compact) and $\mathcal{R}_{Y_{n-1}}(P)$ is invertible in $\mathfrak{A}(\mathcal{G}_{Y_{n-1}})$.*

In (ii) and (iii), we may assume, more generally, that we have $P \in \mathfrak{A}(\mathcal{G})$ or $P \in M_N(\mathfrak{A}(\mathcal{G}))$.

The above theorem extends right away to operators acting on sections of a vector bundle E , the proof being exactly the same. If the representation(s) π_x , $x \in M \setminus Y_{n-1}$, are not injective, then the above theorem gives only sufficient conditions for an operator P as above to be compact or Fredholm.

PROOF: First we need to prove the following lemma:

LEMMA 3 *Let $Y \subset M$ be an invariant subset and let $S^*\mathcal{G}_Y$ be the restriction of the cosphere bundle of $A(\mathcal{G})$, $S^*\mathcal{G} \rightarrow M$, to Y . Then the following sequence is exact:*

$$0 \longrightarrow C^*(\mathcal{G}_{M \setminus Y}) \longrightarrow \mathfrak{A}(\mathcal{G}) \xrightarrow{\mathcal{R}_Y \oplus \sigma_0} \mathfrak{A}(\mathcal{G}_Y) \times_{C_0(S^*\mathcal{G}_Y)} C_0(S^*\mathcal{G}) \longrightarrow 0.$$

Above we have denoted by $\mathfrak{A}(\mathcal{G}_Y) \times_{C_0(S^*\mathcal{G}_Y)} C_0(S^*\mathcal{G})$ the fibered product algebra obtained as the pair of elements (P, f) , $P \in \mathfrak{A}(\mathcal{G}_Y)$ and $f \in C_0(S^*\mathcal{G})$ that map to the same element in $C_0(S^*\mathcal{G}_Y)$.

PROOF: This exact sequence comes out directly from the following commutative diagram:

$$\begin{array}{ccccccc}
 & & 0 & & & & \\
 & & \downarrow & & & & \\
 & & C^*(\mathcal{G}_{M \setminus Y}) & & & & \\
 & & \downarrow & & & & \\
 0 & \rightarrow & C^*(\mathcal{G}) & \rightarrow & \mathfrak{A}(\mathcal{G}) & \xrightarrow{\sigma_0} & C_0(S^*\mathcal{G}) \rightarrow 0 \\
 & & \downarrow & & \downarrow \mathcal{R}_Y & & \downarrow \\
 0 & \rightarrow & C^*(\mathcal{G}_Y) & \rightarrow & \mathfrak{A}(\mathcal{G}_Y) & \rightarrow & C_0(S^*\mathcal{G}_Y) \rightarrow 0 \\
 & & \downarrow & & & & \downarrow \\
 & & 0 & & & & 0
 \end{array}$$

□

We can now prove the theorem itself.

(i) As $\mathcal{G}_{M \setminus Y_{n-1}} = (M \setminus Y_{n-1}) \times (M \setminus Y_{n-1})$, its C^* -algebra is isomorphic to that of compact operators on $L^2(M \setminus Y_{n-1})$.

(ii) A bounded operator $P \in \mathcal{L}(\mathcal{H})$, acting on the Hilbert space \mathcal{H} , is compact if, and only if, its image in the Calkin algebra $Q(\mathcal{H}) := \mathcal{L}(\mathcal{H})/\mathcal{K}(\mathcal{H})$ is zero. The assumption that π_x is injective guarantees that the induced map $\mathfrak{A}(\mathcal{G})/C^*(\mathcal{G}_{M \setminus Y_{n-1}}) \rightarrow Q(\mathcal{H})$ is also injective. Then the lemma above, applied to Y_{n-1} , implies that P is compact if and only if

$$P \in \ker(\mathcal{R}_{Y_{n-1}} \oplus \sigma_0) = \ker \mathcal{R}_{Y_{n-1}} \cap \ker \sigma_0 .$$

(iii) By Atkinson’s theorem, a bounded operator $P \in \mathcal{L}(\mathcal{H})$ is Fredholm if, and only if, its image in the Calkin algebra $Q(\mathcal{H}) := \mathcal{L}(\mathcal{H})/\mathcal{K}(\mathcal{H})$ is invertible. Also, recall that an injective morphism ρ of C^* -algebras has the property that $\rho(T)$ is invertible if, and only if, T is invertible. Thus we can use again the fact that the morphism $\mathfrak{A}(\mathcal{G})/C^*(\mathcal{G}_{M \setminus Y_{n-1}}) \rightarrow Q(\mathcal{H})$ induced by π_x is injective to conclude that P is Fredholm if, and only if, $(\mathcal{R}_{Y_{n-1}} \oplus \sigma_0)(P)$ is invertible, *i.e.* if, and only if, $\mathcal{R}_{Y_{n-1}}(P)$ and $\sigma_0(P)$ are invertible. □

The significance of Theorem 3 is that often in practice we can find nice invariant filtrations of M , possibly given by a stratification of M , such that the subquotients $C^*(\mathcal{G}_{Y_k \setminus Y_{k-1}})$ have a relatively simpler structure than that of $C^*(\mathcal{G})$. In that case, the ideal structure reflects the geometric structure of M [12]. In this context, let us mention only the edge-calculus on manifolds with boundary [13, 16], and the b - resp. cusp-calculus, or, slightly more general, the c_n -calculus on manifolds with corners [10, 13, 22, 23, 26, 27].

Let us now assume, until the end of this section, that \mathcal{G} is a differentiable groupoid. In many cases, the subquotients $C^*(\mathcal{G}_{Y_k \setminus Y_{k-1}})$ are then related to foliation algebras, to which the results of [38] can be applied. Actually, we

can always find an ideal in $\mathfrak{A}(\mathcal{G})$, whose structure resembles that of foliation algebras. The construction of this ideal goes as follows. Recall that for a differentiable groupoid \mathcal{G} there is a canonical map $q : A(\mathcal{G}) \rightarrow TM$ of vector bundles, called the *anchor map*.

Consider, for each $k \leq n = \dim \mathcal{G}_x$, the set

$$X_k \subset M$$

of points x such that the dimension of $q(A(\mathcal{G})_x) \subset T_x M$ is k . Then

$$Y_k := X_0 \cup X_1 \cup \cdots \cup X_k$$

is a closed subset of M . It is known [15], that $\dim(q(A(\mathcal{G})_y))$ is constant for $y \in r(\mathcal{G}_x)$, and hence each X_k is an *invariant* subset of M . If p is the largest integer for which $X_p \neq \emptyset$, then $\mathcal{O} = X_p$ is an open invariant subset of M , foliated by the sets $r(\mathcal{G}_x)$, $x \in \mathcal{O}$. Denote by \mathcal{F} this foliation of \mathcal{O} and by $T\mathcal{F} = q(A(\mathcal{G})|_{\mathcal{O}})$ its tangent space. The set \mathcal{O} will be called the *maximal regular open subset* of M .

Finally, still in the setting of differentiable groupoids, let us define a representation π of $\Psi^{\infty,0}(\mathcal{G})$ on $\mathcal{C}_c^\infty(M)$ by

$$(\pi(P)u) \circ r = P(u \circ r);$$

this representation is called the *vector representation*.

LEMMA 4 *Let \mathcal{O} be an invariant open subset of M . Then the operator $\pi(P)$ map $\mathcal{C}_c^\infty(\mathcal{O})$ to itself.*

PROOF: The support of $\pi(P)u$ is contained in the product

$$\text{supp } (P) \text{ supp } (u),$$

a compact subset of M , which, we claim, does not intersect $Y := M \setminus \mathcal{O}$. Indeed, if we assume by contradiction that

$$y \in Y \cap \text{supp } (P) \text{ supp } (u),$$

then the intersection of $\text{supp } (P)^{-1}Y$ and $\text{supp } (u)$ is not empty. However, this is not possible since we have $\text{supp } (P)^{-1}Y \subset Y$, by the invariance of Y , and $\text{supp } (u) \subset \mathcal{O}$. \square

The representation of $\Psi^{\infty,0}(\mathcal{G})$ on $\mathcal{C}_c^\infty(\mathcal{O})$ obtained in the above lemma will be denoted by $\pi_{\mathcal{O}}$. In particular, $\pi_M = \pi$.

Let \mathcal{F} be the foliation of the maximal regular open subset \mathcal{O} of M . Also, let $\Omega_{\mathcal{F}}$ be the bundle of densities along the fibers of \mathcal{F} . The bundle $\Omega_{\mathcal{F}}$ is trivial and the notion of *positive* section of $\Omega_{\mathcal{F}}$ is defined invariantly. Recall that a *transverse measure* μ on \mathcal{F} is a linear map $\mu : \mathcal{C}_c(\mathcal{O}, \Omega_{\mathcal{F}}) \rightarrow \mathbb{C}$ such that

$\mu(f) \geq 0$ if f is positive. A transverse measure μ on \mathcal{O} gives rise to an inner product $(\cdot, \cdot)_\mu$ on

$$C_c^{\infty,0}(\mathcal{O}; \Omega_{\mathcal{F}}^{1/2})$$

by the formula $(f, g)_\mu := \mu(f\bar{g})$. Let $L^2(\mathcal{O}, d\mu)$ be the completion of $C_c^{\infty,0}(\mathcal{O}, \Omega_{\mathcal{F}})$ with respect to the Hilbert space norm $\|f\|_\mu = (f, f)_\mu^{1/2}$.

THEOREM 5 *For any transverse measure μ on \mathcal{O} the representation $\pi_{\mathcal{O}}$ extends to a bounded $*$ -representation of $\mathfrak{A}(\mathcal{G})$ on $L^2(\mathcal{O}, d\mu)$.*

PROOF: The results from [3] and, more specifically, [38] show that $\pi_{\mathcal{O}}$ extends to a bounded $*$ -representation of $C^*(\mathcal{G}_{M \setminus \mathcal{O}})$. Since $C^*(\mathcal{G}_{M \setminus \mathcal{O}})$ is an ideal in $\mathfrak{A}(\mathcal{G})$, we can extend further $\pi_{\mathcal{O}}$ to a bounded $*$ -representation of $\mathfrak{A}(\mathcal{G})$ acting on the same Hilbert space. \square

The above construction generalizes to give a large class of representations of the algebras $\mathfrak{A}(\mathcal{G})$ for groupoids \mathcal{G} whose spaces of units are endowed with some specific filtrations. Let us assume that $Y_0 \subset Y_1 \subset \dots \subset Y_n = M$ is an invariant filtration, such that for each stratum $S_k = Y_k \setminus Y_{k-1}$, the map $r : \mathcal{G}_x \rightarrow S_k$ has the same rank for all $x \in S_k$. When this is the case, we shall call $M = \cup S_k$ a *regular invariant stratification*. Then each S_k is invariant and foliated by the orbits of \mathcal{G} (whose leaves are the sets $r(\mathcal{G}_x)$, $x \in S$). In particular, each S_k is an invariant open subset of Y_k , and hence plays the role of \mathcal{O} above for the groupoid \mathcal{G}_{Y_k} .

COROLLARY 5 *Let \mathcal{G} be a differentiable groupoid with space of units M . Assume that $M = \cup S$ is a regular, invariant stratification. Then any non-zero transverse measure on a stratum S gives rise to a $*$ -representation of $\mathfrak{A}(\mathcal{G})$.*

PROOF: Any transverse measure on S_k gives rise to a representation of the C^* -algebra $\mathfrak{A}(\mathcal{G}_{Y_k})$, by the above theorem. Then use the restriction morphism $\mathcal{R}_{Y_k} : \mathfrak{A}(\mathcal{G}) \rightarrow \mathfrak{A}(\mathcal{G}_{Y_k})$ to obtain the desired representations. \square

In the following, we shall denote by \otimes_{min} the *minimal* tensor product of C^* -algebras, defined using the tensor product of Hilbert spaces, see [40]. We shall use the following well-known result several times in the last section.

PROPOSITION 2 *If \mathcal{G}_i , $i = 0, 1$, are two differential groupoids, then*

$$C_r^*(\mathcal{G}_0 \times \mathcal{G}_1) \simeq C_r^*(\mathcal{G}_0) \otimes_{min} C_r^*(\mathcal{G}_1).$$

PROOF: Let M_0 and M_1 be the space of units of \mathcal{G}_0 and \mathcal{G}_1 , and define

$$\mathcal{H}_i = \bigoplus_{x \in M_i} L^2((\mathcal{G}_i)_x)$$

[respectively, $\mathcal{H} = \bigoplus_{x \in M_0 \times M_1} L^2((\mathcal{G}_0 \times \mathcal{G}_1)_x)$] to be the space of the total regular representation of $\Psi^{-\infty}(\mathcal{G}_i)$ [respectively, of $\Psi^{-\infty}(\mathcal{G}_0 \times \mathcal{G}_1)$]. Then the

reduced C^* -algebras $C_r^*(\mathcal{G}_i)$ [respectively, $C_r^*(\mathcal{G}_0 \times \mathcal{G}_1)$] are the completions of $\Psi^{-\infty}(\mathcal{G}_i)$ [respectively, of $\Psi^{-\infty}(\mathcal{G}_0 \times \mathcal{G}_1)$] acting on \mathcal{H}_i [respectively, on \mathcal{H}]. Let $\overline{\otimes}$ be the completed tensor product of Hilbert spaces. Since $\mathcal{H} \simeq \mathcal{H}_0 \overline{\otimes} \mathcal{H}_1$, the isomorphism

$$C_r^*(\mathcal{G}_0 \times \mathcal{G}_1) \simeq C_r^*(\mathcal{G}_0) \otimes_{min} C_r^*(\mathcal{G}_1)$$

follows directly from the definition of the minimal C^* -algebra tensor product of $C_r^*(\mathcal{G}_0)$ and $C_r^*(\mathcal{G}_1)$ as the completion of $C_r^*(\mathcal{G}_0) \otimes C_r^*(\mathcal{G}_1)$ acting on $\mathcal{H}_0 \otimes \mathcal{H}_1$. \square

5 APPLICATIONS TO INDEX THEORY ON SINGULAR SPACES

We now discuss in greater detail two examples, the adiabatic limit groupoid and the “ b - Γ -groupoid.” The first example is relevant for the index theory on singular manifolds, or open manifolds with a uniform structure at infinity; it generalizes the construction of the tangent groupoid, that plays a key role in index theory as showed in [4]. The second example is related to the theory of elliptic (or Fredholm) boundary value problems.

Let X be a locally compact space and B be a Banach algebra. We shall denote, as usual, by $\mathcal{C}_0(X; B)$ the space of continuous functions $X \rightarrow B$ that vanish in norm at infinity. Also, recall that $K_i(\mathcal{C}_0(\mathbb{R}, B)) \simeq K_{i-1}(B)$ and $K_0(\mathcal{C}_0(X)) \simeq K^0(X)$.

If \mathcal{G} is a continuous family groupoid with space of units M , then we construct its *adiabatic groupoid*, denoted \mathcal{G}_{ad} , as follows. First, the space of units of \mathcal{G}_{ad} is $M \times [0, \infty)$.

The underlying set of the groupoid \mathcal{G}_{ad} is the disjoint union:

$$\mathcal{G}_{ad} = A(\mathcal{G}) \times \{0\} \cup \mathcal{G} \times (0, \infty).$$

We endow $A(\mathcal{G}) \times \{0\}$ with the structure of a commutative bundle of Lie groups and $\mathcal{G} \times (0, \infty)$ with the product (or pointwise) groupoid structure. Then the groupoid operations of \mathcal{G}_{ad} are such that $A(\mathcal{G}) \times \{0\}$ and $\mathcal{G} \times (0, \infty)$ are subgroupoids with the induced structure.

Now let us endow this groupoid with a continuous family groupoid structure. Let us consider an atlas (Ω) .

Let Ω be a chart of \mathcal{G} , such that $\Omega \cap \mathcal{G}^{(0)} \neq \emptyset$; one can assume without loss of generality that $\Omega \simeq T \times U$ with respect to d , and $\Omega \simeq T' \times U$ with respect to r ; let us denote by ϕ and ψ these homeomorphisms. Thus, if $x \in U$, $\mathcal{G}_x \simeq T$, and $A(\mathcal{G})_U \simeq \mathbb{R}^k \times U$. Let $(\Theta_x)_{x \in U}$ (resp. $(\Theta'_x)_{x \in U}$) be a continuous family of diffeomorphisms from \mathbb{R}^k to T (resp. T') such that $\iota(x) = \phi(\Theta_x(0), x)$ (resp. $\iota(x) = \psi(\Theta'_x(0), x)$), where ι denotes the inclusion of $\mathcal{G}^{(0)}$ into \mathcal{G} .

Then $\overline{\Omega} = A(\mathcal{G})_U \times \{0\} \cup \Omega \times (0, \infty)$ is an open subset of \mathcal{G}_{ad} , homeomorphic

to $\mathbb{R}^k \times U \times \mathbb{R}_+$ with respect to d and to r as follows:

$$\begin{aligned} \bar{\phi}(\xi, u, \alpha) &= \begin{cases} (\phi(\Theta_u(\alpha\xi), u), \alpha) & \text{if } \alpha \neq 0 \\ (\xi, u, 0) & \text{if } \alpha = 0 \end{cases} \\ \bar{\psi}(\xi, u, \alpha) &= \begin{cases} ((\phi(\Theta_u(\alpha\xi), u))^{-1}, \alpha) & \text{if } \alpha \neq 0 \\ (\xi, u, 0) & \text{if } \alpha = 0 \end{cases} \end{aligned}$$

This defines an atlas of \mathcal{G}_{ad} , endowing it with a continuous family groupoid structure.

The tangent groupoid of \mathcal{G} is defined to be the restriction of \mathcal{G}_{ad} to $M \times [0, 1]$. We are interested in the adiabatic groupoid (or in the tangent groupoid) because it may be used to formalize certain constructions in index theory, as we shall show below.

First, note that

$$M \times [0, \infty) = M \times \{0\} \cup M \times (0, \infty)$$

is an invariant stratification of the space of units. Consequently, Theorem 3 gives rise to the short exact sequence

$$0 \rightarrow SC^*(\mathcal{G}) := \mathcal{C}_0((0, \infty), C^*(\mathcal{G})) \rightarrow C^*(\mathcal{G}_{ad}) \rightarrow \mathcal{C}_0(A^*(\mathcal{G})) \rightarrow 0.$$

The boundary map ∂ of the K -theory six term exact sequence associated to the above exact sequence of C^* -algebras then provides us with a map

$$\text{ind}_a : K^i(A^*(\mathcal{G})) = K_i(\mathcal{C}_0(A^*(\mathcal{G}))) \xrightarrow{\partial} K_{i+1}(SC^*(\mathcal{G})) \simeq K_i(C^*(\mathcal{G})), \quad (24)$$

the *analytic index morphism*, which we shall discuss below in relation with the Fredholm index. Remark that this morphism does not necessarily take its values in \mathbb{Z} ; however, in the case of the groupoid $M \times M$ of a smooth manifold M one has $K_i(C^*(M \times M)) = \mathbb{Z}$.

We assume from now on, for simplicity, that M , the space of units of \mathcal{G} , is compact. Let $P = (P_x) \in \Psi^{m,0}(\mathcal{G}; E_0, E_1)$ be a family of *elliptic* operators acting on sections of $r^*(E_0)$, with values sections of $r^*(E_1)$, for some bundles E_0 and E_1 on M . (Here “elliptic” means, as before, that the principal symbol is invertible.) We shall denote the pull-backs of E_0 and E_1 to $A^*(\mathcal{G})$ by the same letters. Then the triple $(E_0, E_1, \sigma_m(P))$ defines an element $[\sigma_m(P)]$ in $K^0(A^*(\mathcal{G}))$, the K -theory groups with compact supports of $A^*(\mathcal{G})$. Furthermore, the morphism ind_a provides us with an element $\text{ind}_a([\sigma_m(P)])$, which we shall also write as $\text{ind}_a(P)$, and call the *analytic index* of the family P . As we shall see below, this construction generalizes the usual analytic (or Fredholm) index of elliptic operators.

Suppose now that $M = \cup S$ is an invariant stratification of the space of units of the continuous family groupoid \mathcal{G} . Then we obtain a natural, invariant stratification of the space of units of \mathcal{G}_{ad} as

$$M \times [0, \infty) = \bigcup_S (S \times (0, \infty)) \cup M \times \{0\}.$$

To recover the Fredholm index, we shall assume that there exists a unique stratum of maximal dimension in the above stratification, let us call it S_{\max} , and let us assume that the restriction of \mathcal{G} to S_{\max} is the product groupoid:

$$\mathcal{G}_{S_{\max}} := r^{-1}(S_{\max}) = d^{-1}(S_{\max}) \simeq S_{\max} \times S_{\max}. \quad (25)$$

Let \mathcal{K} denote the algebra of compact operators on $L^2(S_{\max}) \simeq L^2(M)$. Then $S_{\max} \times (0, \infty)$ is the unique stratum of maximal dimension of $M \times [0, \infty)$, and the ideal associated to it is $SK := \mathcal{C}_0((0, \infty), \mathcal{K})$. This leads to an exact sequence of C^* -algebras

$$0 \rightarrow SK \rightarrow C^*(\mathcal{G}_{ad}) \rightarrow Q(\mathcal{G}_{ad}) \rightarrow 0, \quad (26)$$

where $Q(\mathcal{G}_{ad}) := C^*(\mathcal{G}_{ad})/\mathcal{C}_0((0, \infty), \mathcal{K})$.

As above, this exact sequence of C^* -algebras leads to a six term exact sequence in K -theory, and hence to a map

$$\text{ind}_f : K_0(Q(\mathcal{G}_{ad})) \xrightarrow{\partial} K_1(SK) \simeq \mathbb{Z}. \quad (27)$$

(The second isomorphism is obtained from the boundary map associated to the exact sequence

$$0 \rightarrow SK \rightarrow \mathcal{C}_0((0, \infty], \mathcal{K}) \rightarrow \mathcal{K} \rightarrow 0.)$$

Below we shall use the ‘‘graph projection’’ of a densely defined, unbounded operator P , which we now define. Let τ be a smooth, even function on \mathbb{R} satisfying $\tau(x^2)^2 x^2 = e^{-x^2}(1 - e^{-x^2})$. Then *the graph projection* of P is

$$\mathbb{B}(P) = \begin{bmatrix} 1 - e^{-P^*P} & \tau(P^*P)P^* \\ \tau(P P^*)P & e^{-P P^*} \end{bmatrix}. \quad (28)$$

This projection is also called the Bott or the Wasserman projection by some authors. Also, let

$$e_0 = \begin{bmatrix} 1 & 0 \\ 0 & 0 \end{bmatrix}.$$

Denote by $\rho : Q(\mathcal{G}_{ad}) \rightarrow \mathcal{C}_0(A^*(\mathcal{G}))$ the canonical projection, and let

$$\rho_* : K_i(Q(\mathcal{G}_{ad})) \rightarrow K_i(\mathcal{C}_0(A^*(\mathcal{G})))$$

be the morphism induced on K -theory. For operators of positive order, we shall consider Sobolev spaces on S_{\max} , defined using the bounded geometry metric on S_{\max} obtained from a metric on $A(\mathcal{G})$ (recall that we assume M to be compact, and that S_{\max} is smooth as it is a fiber of \mathcal{G}). We then have the following result.

PROPOSITION 3 *Let S_{\max} and \mathcal{G} be as above, $\mathcal{G}_{S_{\max}} \simeq S_{\max} \times S_{\max}$. Assume that the regular representation $\pi_x : \mathfrak{A}(\mathcal{G}) \rightarrow \mathcal{L}(L^2(\mathcal{G}_x)) \simeq \mathcal{L}(L^2(S_{\max}))$, associated to some $x \in S_{\max}$, is injective. If $P \in \Psi^{m,0}(\mathcal{G}; E_0, E_1)$ is a Fredholm differential operator $H^m(S_{\max}) \rightarrow L^2(S_{\max})$, then it defines a canonical class $[P] \in K_0(Q(\mathcal{G}_{ad}))$ such that $\rho_*([P]) = [\sigma_m(P)]$ and $\text{ind}_f([P])$ coincides with the Fredholm index of P .*

PROOF: We may assume that the family P consists of operators of order $m > 0$. The Fredholmness of P implies that $\sigma_m(P)$ is invertible outside the zero section, by Theorem 4.

Because P is a family of differential operator of order m , we can define a new family $Q \in \Psi^{m,0}(\mathcal{G}_{ad})$ by

$$Q_{(x,t)} = t^m P_x, \text{ if } (x, t) \in M \times (0, \infty),$$

and

$$Q_{(x,0)} = \sigma_m(P),$$

a polynomial function on $A(\mathcal{G})_x^* \times \{0\}$ (the complete symbol of a homogeneous differential operator on $A(\mathcal{G})_x$).

Moreover, let $\mathcal{C}_0((0, \infty], \mathcal{K})$ be the space of all continuous functions $(0, \infty) \rightarrow \mathcal{K}$ vanishing for $t \rightarrow 0$ and having limits for $t \rightarrow \infty$. Also, let us denote by \mathcal{B} the algebra $\mathcal{B} := C^*(\mathcal{G}_{ad}) + \mathcal{C}_0((0, \infty], \mathcal{K})$.

Consider now the graph projection $\mathbb{B}(Q)$. The algebra \mathcal{B} can be identified with a subalgebra of $\mathcal{C}_0((0, \infty], \mathcal{L}(L^2(S_{\max}))$), naturally. Then $\mathbb{B}(Q)$ identifies with the function whose value at $t > 0$ is $\mathbb{B}(t^m P)$. Because of

$$\lim_{t \rightarrow \infty} \mathbb{B}(t^m P) = \begin{pmatrix} 1 - \pi_{N(P)} & 0 \\ 0 & \pi_{N(P^*)} \end{pmatrix},$$

where $\pi_{N(P)}$ [respectively $\pi_{N(P^*)}$] stands for the orthogonal projection onto the kernel $N(P)$ [respectively the cokernel $N(P^*)$], we have $\mathbb{B}(t^m P) - e_0 \in M_N(\mathcal{B})$, thus, we obtain a class $[\mathbb{B}(t^m P)] - [e_0] \in K_0(\mathcal{B})$. (The scalar matrix e_0 was defined shortly before the statement of this theorem.) Let us observe now that the C^* -algebra \mathcal{B} fits into the following commutative diagram with exact rows.

$$\begin{array}{ccccccccc} 0 & \longrightarrow & \mathcal{C}_0((0, \infty), \mathcal{K}) & \longrightarrow & C^*(\mathcal{G}_{ad}) & \longrightarrow & Q(\mathcal{G}_{ad}) & \longrightarrow & 0 \\ & & \downarrow id & & \downarrow & & \downarrow id \oplus 0 & & \\ 0 & \longrightarrow & \mathcal{C}_0((0, \infty), \mathcal{K}) & \longrightarrow & \mathcal{B} & \xrightarrow{q} & Q(\mathcal{G}_{ad}) \oplus \mathcal{K} & \longrightarrow & 0 \\ & & \uparrow id & & \uparrow & & \uparrow 0 \oplus id & & \\ 0 & \longrightarrow & \mathcal{C}_0((0, \infty), \mathcal{K}) & \longrightarrow & \mathcal{C}_0((0, \infty], \mathcal{K}) & \longrightarrow & \mathcal{K} & \longrightarrow & 0 \end{array}$$

We shall use this information in the following way. The two right vertical morphisms identify $K_*(q(\mathcal{B})) \cong K_*(Q(\mathcal{G}_{ad})) \oplus K_*(\mathcal{K})$. We shall decompose accordingly the elements in $K_*(q(\mathcal{B}))$. Thus, there exists a uniquely defined class $[P] \in K_0(Q(\mathcal{G}_{ad}))$ satisfying

$$\begin{aligned} q_*([\mathbb{B}(t^m P)] - [e_0]) &= \left([P], \left[\begin{pmatrix} 1 - \pi_{N(P)} & 0 \\ 0 & \pi_{N(P^*)} \end{pmatrix} \right] - [e_0] \right) \\ &= ([P], -[\pi_{N(P)}] + [\pi_{N(P^*)}]). \end{aligned}$$

The property $\rho_*([P]) = [\sigma_m(P)]$ is now an immediate consequence of the definitions.

Let now $\partial : K_0(\cdot) \rightarrow K_1(\mathcal{C}_0((0, \infty), \mathcal{K})) \cong K_0(\mathcal{K}) \cong \mathbb{Z}$ be the boundary maps of the corresponding three cyclic 6-term exact sequences. Note that all the previous isomorphisms are canonical, as explained above. Then we get

$$0 = \partial q_*([\mathbb{B}(t^m P)] - [e_0]) = \partial[P] + \partial(-[\pi_{N(P)}] + [\pi_{N(P^*)}]) = \text{ind}_f([P]) - \text{ind}(P),$$

where $\text{ind}(P)$ is the Fredholm index. This completes the proof. \square

We now briefly discuss a different example, that of elliptic operators on coverings of manifolds with boundary and interpret in our framework the existence of spectral sections considered in [14] and [24]. We need to remind first two constructions, the first one is that of the “*b*-groupoid” associated to a manifold with boundary and the second one is that of the groupoid associated to a covering of a manifold without boundary.

Let M be a manifold with boundary with fundamental group Γ acting on \widetilde{M} . We need to first recall the definition of the *b*-groupoid of M . For the simplicity of the presentation, we shall assume that the boundary of M is *connected*. Not all results extend to the case when ∂M is not connected. (We are indebted to Severino Melo for this remark.) The *b*-groupoid $\mathcal{G}_{M,b}$ is a submanifold of the *b*-stretched product defined by Melrose [18, 19]. It consists of the disjoint union of $\partial M \times \partial M \times \mathbb{R}$ and $(M \setminus \partial M) \times (M \setminus \partial M)$, with groupoid operations induced from the product groupoid structures on each component. Choose a defining function f of the boundary of M . Then the topology on $\mathcal{G}_{M,b}$ is such that

$$(y_n, z_n) \rightarrow (y, z, t) \in \partial M \times \partial M \times \mathbb{R}$$

if, and only if,

$$(y_n, z_n) \rightarrow (y, z)$$

in $M \times M$ and

$$\log f(y_n) - \log f(z_n) \rightarrow t.$$

Second, recall that if π is a discrete group that acts freely on the space X , then $(X \times X)/\pi$ is naturally a groupoid with units X/π , such that the domain and the range maps are the projections onto the first and, respectively, onto the second variable. The composition is such that $(x, y)\pi \circ (y, z)\pi = (x, z)\pi$.

We are now ready to define the *b*- Γ -groupoid associated to a covering

$$\Gamma \rightarrow \widetilde{M} \rightarrow M$$

(with Γ the group of deck transformations) of a manifold with boundary M . This groupoid will be denoted $\mathcal{G}_{\widetilde{M},b}$. To form the groupoid $\mathcal{G}_{\widetilde{M},b}$, we proceed in a similar way, by combining the above two constructions. Consider first the actions of Γ on $\widetilde{M} \setminus \partial \widetilde{M}$ and on $\partial \widetilde{M}$ to form the induced groupoids

$$\mathcal{G}_1 = ((\widetilde{M} \setminus \partial \widetilde{M}) \times (\widetilde{M} \setminus \partial \widetilde{M}))/\Gamma$$

and

$$\mathcal{G}_2 = (\partial\widetilde{M} \times \partial\widetilde{M})/\Gamma.$$

Then we form the disjoint union

$$\mathcal{G}_{\widetilde{M},b} := (\mathcal{G}_2 \times \mathbb{R}) \cup \mathcal{G}_1,$$

to which we give the structure of a continuous family groupoid by requiring that the projection $\mathcal{G}_{\widetilde{M},b} \rightarrow \mathcal{G}_{M,b}$ is a local diffeomorphism. (Here $\mathcal{G}_{M,b}$ is Melrose's b -groupoid, as above.)

Let \mathcal{T}_0 denote $C^*(\mathcal{G}_{I,b})$, if I is the manifold with boundary $[0, \infty)$. Then \mathcal{T}_0 is the closure of the algebra of Wiener-Hopf operators acting on $[0, \infty)$, and hence its closure is isomorphic to the (non-unital) Toeplitz algebra, defined as the kernel of the evaluation at 1 of the symbol map of a Toeplitz operator. In other words, if \mathcal{T} denotes the C^* -algebra of Toeplitz operators on the unit circle, then we have an exact sequence

$$0 \rightarrow \mathcal{T}_0 \rightarrow \mathcal{T} \rightarrow \mathbb{C} \rightarrow 0.$$

The structure of the C^* -algebra $C^*(\mathcal{G}_{\widetilde{M},b})$ is given by the isomorphism

$$C^*(\mathcal{G}_{\widetilde{M},b}) \cong \mathcal{T}_0 \otimes C^*(\Gamma) \otimes \mathcal{K}$$

and similarly for the reduced algebras. Since the reduced Toeplitz algebra \mathcal{T}_0 is contractible, the K -groups of $C^*(\mathcal{G}_{\widetilde{M},b})$ vanish, and hence the map

$$p_* : K_*(\mathfrak{A}(\mathcal{G}_{\widetilde{M},b})) \longrightarrow K_*(\mathfrak{A}(\mathcal{G}_{\widetilde{M},b})/C^*(\mathcal{G}_{\widetilde{M},b})) \cong K_*(\mathcal{C}(S^*M)),$$

induced by the canonical projection $p : \mathfrak{A}(\mathcal{G}_{\widetilde{M},b}) \longrightarrow \mathfrak{A}(\mathcal{G}_{\widetilde{M},b})/C^*(\mathcal{G}_{\widetilde{M},b})$, is an isomorphism. On the other hand, let $p_1 : \mathfrak{A}(\mathcal{G}_{\widetilde{M},b}) \longrightarrow \mathfrak{A}(\mathcal{G}_{\widetilde{M},b})/C^*(\mathcal{G}_1)$ and $q : \mathfrak{A}(\mathcal{G}_{\widetilde{M},b})/C^*(\mathcal{G}_1) \longrightarrow \mathfrak{A}(\mathcal{G}_{\widetilde{M},b})/C^*(\mathcal{G}_{\widetilde{M},b})$ be the obvious projection maps. Then we have $p = q \circ p_1$, which gives the surjectivity of the induced map

$$q_* : K_*(\mathfrak{A}(\mathcal{G}_{\widetilde{M},b})/C^*(\mathcal{G}_1)) \longrightarrow K_*(\mathfrak{A}(\mathcal{G}_{\widetilde{M},b})/C^*(\mathcal{G}_{\widetilde{M},b})) \cong K_*(\mathcal{C}(S^*M)).$$

(Here it is essential to assume that ∂M is connected.)

Consequently, any elliptic operator $P \in M_N(\Psi^{m,0}(\mathcal{G}_{\widetilde{M},b}))$ (which identifies with a Γ -invariant b -pseudodifferential operator acting on a trivial vector bundle on \widetilde{M}) has a perturbation by an element in $M_N(\Psi^{-\infty,0}(\mathcal{G}_{\widetilde{M},b}))$ to an operator in $M_N(\Psi^{m,0}(\mathcal{G}_{\widetilde{M},b}))$ that has an invertible boundary indicial map. (This is proved as the corresponding statement in [31].) Consequently, this perturbation is $C^*(\Gamma)$ -Fredholm, in the sense of Mishenko and Fomenko, [25]. The existence of this kind of perturbations was obtained before in [14] using the concept of spectral section. A completely similar argument can be used in the study of elliptic boundary value problems for families of elliptic operators to prove that every family of elliptic b -pseudodifferential operators on a manifold with boundary has a perturbation by a family of regularizing operators that makes this family a family of Fredholm operators. This result was obtained in [24] also using spectral sections.

REFERENCES

- [1] R. Almeida and P. Molino, *Suites d'Atiyah et feuilletages transversalement complets*, C.R. Acad. Sci. Paris 300 (1985), 13–15.
- [2] J.-L. Brylinski and V. Nistor, *Cyclic cohomology of étale groupoids*, K-Theory 8 (1994), 341–365.
- [3] A. Connes. *Sur la théorie non commutative de l'intégration*. Algèbres d'opérateurs, LNM 725, Springer Verlag, 19–143, 1979.
- [4] A. Connes. *Noncommutative Geometry*. Academic Press, New York - London, 1994.
- [5] J. Dixmier. *Von Neumann algebras*. North-Holland, Amsterdam - New York - Oxford, 1981.
- [6] L. Hörmander. Fourier integral operators I. *Acta Math.*, 127:79–183, 1971.
- [7] L. Hörmander, *The analysis of linear partial differential operators*, vol. 1, Springer-Verlag, Berlin, Heidelberg, New York, Tokyo, 1983.
- [8] L. Hörmander, *The analysis of linear partial differential operators*, vol. 3, Springer-Verlag, Berlin, Heidelberg, New York, Tokyo, 1985.
- [9] R. Lauter. On the existence and structure of Ψ^* -algebras of totally characteristic operators on compact manifolds with boundary. *J. Functional Analysis*, 169:81–120, 1999.
- [10] R. Lauter. The length of C^* -algebras of b-pseudodifferential operators. *Proc. of the Amer. Math. Soc.*, 128:1955–1961, 2000.
- [11] R. Lauter and S. Moroianu. Fredholm theory for degenerate pseudodifferential operators on manifolds with fibered boundaries. to appear in: *Comm. Partial Differential Equations*.
- [12] R. Lauter and V. Nistor. Pseudodifferential analysis on groupoids and singular spaces. Preprint Nr. 12/99, Fachbereich Mathematik, Johannes Gutenberg-Universität Mainz, June 1999.
- [13] R. Lauter and V. Nistor. Analysis of geometric operators on open manifolds: a groupoid approach. Heft 108, Universität Münster, SFB 478 *Geometrische Strukturen in der Mathematik*, May 2000. to appear in: *Quantization of Singular Symplectic Quotients*, Edts. N. P. Landsman, M. Pflaum, M. Schlichtenmaier, Birkhäuser, Basel.
- [14] E. Leichtnam and P. Piazza, *Spectral sections and higher Atiyah-Patodi-Singer index theory on Galois coverings*, *Geom. Funct. Anal.*, 8 (1998), 1–58.
- [15] K. Mackenzie, *Lie groupoids and Lie algebroids in differential geometry*, Lecture Notes Series 124, London Mathematical Society, 1987.
- [16] R. R. Mazzeo. Elliptic theory of differential edge operators I. *Comm. Partial Differential Equations*, 16:1615–1664, 1991.

- [17] R. R. Mazzeo and R. B. Melrose. Pseudodifferential operators on manifolds with fibered boundaries. *Asian J. Math.*, 2:833–866, 1998.
- [18] R. B. Melrose. Transformation of boundary value problems. *Acta Math.*, 147:149–236, 1981.
- [19] R. B. Melrose, *The Atiyah-Patodi-Singer index theorem*, A.K. Peters, Wellesley, Mass. 1993.
- [20] R. B. Melrose, *Geometric scattering theory*, Stanford Lectures, Cambridge University Press, Cambridge, 1995.
- [21] R. B. Melrose. Fibrations, compactifications and algebras of pseudodifferential operators. In L. Hörmander and A. Mellin, editors, *Partial Differential Equations and Mathematical Physics*, pages 246–261, 1996.
- [22] R. B. Melrose and V. Nistor, *K-Theory of C^* -algebras of b -pseudodifferential operators*, *Geom. Funct. Anal.* 8 (1998), 99–122.
- [23] R. B. Melrose and P. Piazza. Analytic K-theory on manifolds with corners. *Adv. Math.*, 92:1–26, 1992.
- [24] R. B. Melrose and P. Piazza, *Families of Dirac operators, boundaries, and the b -calculus*, *J. Diff. Geom.*, 146 (1997), 99–180.
- [25] A. Mishenko and A. Fomenko, *The index of elliptic operators over C^* -algebras*, *Izv. Akad. Nauk SSSR, Ser. Mat.* 43 (1979), 831–859.
- [26] B. Monthubert. Groupoïdes et calcul pseudo-différentiel sur les variétés à coins *PhD thesis*, Université Paris 7 (1998).
- [27] B. Monthubert. Pseudodifferential calculus on manifolds with corners and groupoids, *Proc. Amer. Math. Soc.* 127,10 (1999), pages 2871–2881.
- [28] B. Monthubert and F. Pierrot. Indice analytique et groupoïdes de Lie. *C. R. Acad. Sci. Paris Ser. I*, 325(2):193–198, 1997.
- [29] V. Nistor, A. Weinstein, and P. Xu. *Pseudodifferential operators on groupoids*. *Pacific. J. Math.* 189 (1999), 117–152.
- [30] V. Nistor, *Groupoids and the integration of Lie algebroids*, Penn State Preprint No. 205 (1998), to appear.
- [31] V. Nistor, *An index theorem for families of operators invariant with respect to a bundle of Lie groups*, Inst. Fourier preprint 1999, revised in 2000.
- [32] A. L. T. Paterson, *Continuous family groupoids*, Preprint.
- [33] B. A. Plamenevskij and V. N. Senichkin. Solvable algebras of operators. *St. Petersburg Math. J.*, 6:895–968, 1995. Originally published in Russian – *Algebra i Anal.*, 1994.
- [34] J. Pradines, *Troisième théorème de Lie pour les groupoïdes différentiables*, *C. R. Acad. Sci. Paris, Série A* 267 (1968), 21–23.
- [35] J. Pradines, *Théorie de Lie par les groupoïdes différentiables*, *C. R. Acad. Sci. Paris, Série A* 267 (1968), 245–248.

- [36] B. Ramazan, *Quantification par Déformation des variété de Lie-Poisson*, Ph.D. Thesis, Orléans (1998).
- [37] J. Renault, *A groupoid approach to C^* -algebras*, Lect. Notes in Math., vol. 793, Springer, Berlin-Heidelberg-New York, 1980.
- [38] J. Renault, *Représentation des produits croisé d'algèbres de groupoïdes*, J. Operator Theory, 93 (1987), 67–97.
- [39] G.S. Rinehart, *Differential forms on general commutative algebras*, Trans. Amer. Math. Soc. 108 (1963), 195–222.
- [40] S. Sakai, *C^* -algebras and W^* -algebras*, reprint of the 1971 edition. *Classics in Mathematics*, Springer-Verlag, Berlin, 1998, xii+256.
- [41] B.-W. Schulze. *Pseudo-differential boundary value problems, conical singularities, and asymptotics*. Akademie Verlag, Berlin, 1994.
- [42] E. Winkelkemper, *The graph of a foliation*, Ann. Global Anal. Geom. 1 (1983), 51–75.
- [43] E. Witten, *Global gravitational anomalies*, Comm. Math. Phys. 100 (1985), 197–229.

Robert Lauter
Universität Mainz
FB 17-Mathematik
D-55099 Mainz
Germany
lauter@mathematik.uni-mainz.de

Bertrand Monthubert
Laboratoire Emile Picard
Université Paul Sabatier (UFR MIG)
118 route de Narbonne
F-31062 Toulouse CEDEX 4
monthube@picard.ups-tlse.fr

Victor Nistor
Pennsylvania State
University, Math. Dept.
University Park, PA 16802
nistor@math.psu.edu

LOCAL LEOPOLDT'S PROBLEM
FOR RINGS OF INTEGERS IN ABELIAN p -EXTENSIONS
OF COMPLETE DISCRETE VALUATION FIELDS

M. V. BONDARKO

Received: April 12, 2000

Revised: December 8, 2000

Communicated by A. S. Merkuriev

ABSTRACT. Using the standard duality we construct a linear embedding of an associated module for a pair of ideals in an extension of a Dedekind ring into a tensor square of its fraction field. Using this map we investigate properties of the coefficient-wise multiplication on associated orders and modules of ideals. This technique allows to study the question of determining when the ring of integers is free over its associated order. We answer this question for an Abelian totally wildly ramified p -extension of complete discrete valuation fields whose different is generated by an element of the base field. We also determine when the ring of integers is free over a Hopf order as a Galois module.

1991 Mathematics Subject Classification: 11S15, 11S20, 11S31

Keywords and Phrases: Complete discrete valuation (local) fields, additive Galois modules, formal groups, associated Galois modules

INTRODUCTION

0.1. Additive Galois modules and especially the ring of integers of local fields are considered from different viewpoints. Starting from H. Leopoldt [L] the ring of integers is studied as a module over its associated order. To be precise, if K is an extension of a local field k with Galois group being equal to G and \mathfrak{D}_K is the ring of integers of K , then \mathfrak{D}_K is considered as a module over $\mathfrak{A}_{K/k}(\mathfrak{D}_K) = \{\lambda \in k[G], \lambda \mathfrak{D}_K \subset \mathfrak{D}_K\}$.

One of the main questions is to determine when \mathfrak{D}_K is free as an $\mathfrak{A}_{K/k}(\mathfrak{D}_K)$ -module. Another related problem is to describe explicitly the ring $\mathfrak{A}_{K/k}(\mathfrak{D}_K)$ (cf. [Fr], [Chi], [CM]).

This question was actively studied by F. Bertrandias and M.-J. Ferton (cf. [Be], [B-F], [F1-2]) and more recently by M. J. Taylor, N. Byott and G. Lettl (cf. [T1], [By], [Le1]).

In particular, G. Lettl proved that if K/\mathbb{Q}_p is Abelian and $k \subset K$, then $\mathfrak{D}_K \approx \mathfrak{A}_{K/k}(\mathfrak{D}_K)$ (cf. [Le1]). The proof was based on the fact that all Abelian extensions of \mathbb{Q}_p are cyclotomic. So the methods of that paper and of most of preceding ones are scarcely applicable in more general situations.

M. J. Taylor [T1] considers intermediate extensions in the tower of Lubin-Tate extensions. He proves that for some of these extensions \mathfrak{D}_K is a free $\mathfrak{A}_{K/k}(\mathfrak{D}_K)$ -module. Taylor considers a formal Lubin-Tate group $F(X, Y)$ over the ring of integers \mathfrak{o} of a local field k . Let π be a prime element of the field k and T_m be equal to $\text{Ker}[\pi^m]$ in the algebraic closure of the field k . For $1 \leq r \leq m$, let L be equal to $k(T_{m+r})$, and let K be equal to $k(T_m)$. Lastly, let q be the cardinality of the residue field of k .

Taylor proves that

- (1) the ring \mathfrak{D}_L is a free $\mathfrak{A}_{L/K}(\mathfrak{D}_L)$ -module and any element of L whose valuation is equal to $q^r - 1$ generates it, and
- (2) $\mathfrak{A}_{L/K}(\mathfrak{D}_L) = \mathfrak{D}_K + \sum_{i=0}^{q^r-2} \mathfrak{D}_K \sigma_i$, where $\sigma_i \in K[G]$ and are described explicitly (cf. the details in [T1], subsection 1.4).

This result was generalized to relative formal Lubin-Tate groups in the papers [Ch] and [Im]. Results of these papers were proved by direct computation. So these works do not show how one can obtain a converse result, i.e., how to find all extensions, that fulfill some conditions on the Galois structure of the ring of integers. To the best of author's knowledge the only result obtained in this direction was proved in [By1] and refers only to cyclotomic Lubin-Tate extensions.

0.2. In the examples mentioned above the associated order is also a Hopf order in the group algebra (i.e., it is an order stable under comultiplication). Several authors are interested in this situation. The extra structure allows to deal with wild extensions as if they were tame (in some sense). This is why in this situation, following Childs, one speaks of "taming wild extensions by Hopf orders". In the paper [By1], Byott proves that the associated order can be a Hopf order only in the case when the different of the extension is generated by an element of the smaller field. The present paper is also dedicated to extensions of this sort. More precisely, Theorem 4.4 of the paper [By1] implies that the order $\mathfrak{A}_{K/k}(\mathfrak{D}_K)$ can be a Hopf order (in the case when the ring \mathfrak{D}_K is $\mathfrak{o}[G]$ -indecomposable) only if K/k fulfills the stated condition on the different and \mathfrak{D}_K is free over $\mathfrak{A}_{K/k}(\mathfrak{D}_K)$. Our main Theorem settles completely the question to determine when the order $\mathfrak{A}_{K/k}(\mathfrak{D}_K)$ is a Hopf order. It also describes completely Hopf orders that can be obtained as associated Galois orders. We shall also prove in subsection 3.4 that under the present assumptions if \mathfrak{D}_K is free over $\mathfrak{A}_{K/k}(\mathfrak{D}_K)$, then $\mathfrak{A}_{K/k}(\mathfrak{D}_K)$ is a Hopf order and determine when the inverse different of an Abelian totally ramified p -extension of a complete discrete valuation field is free over its associated order (cf. [By1] Theorem 3.10).

In the first section we study a more general situation. We consider a Galois extension K/k of fraction fields of Dedekind rings, with Galois group G . We prove a formula for the module

$$\mathfrak{C}_{K/k}(I_1, I_2) = \text{Hom}_{\mathfrak{o}}(I_1, I_2) ,$$

where I_1, I_2 are fractional ideals of K (this set also can be defined for ideals that are not G -stable) in Theorem 1.3.1. We introduce two submodules of $\mathfrak{C}_{K/k}(I_1, I_2)$:

$$\begin{aligned} \mathfrak{A}_{K/k}(I_1, I_2) &= \{f \in k[G] \mid f(I_1) \subset I_2\} \\ \mathfrak{B}_{K/k}(I_1, I_2) &= \text{Hom}_{\mathfrak{o}[G]}(I_1, I_2) , . \end{aligned}$$

These modules coincide in the case when K/k is Abelian (cf. Proposition 1.4.2). We call these modules the *associated modules* for the pair I_1, I_2 . In case $I_1 = I_2$ we call the associated module *associated order*.

In subsection 1.5 we define a multiplication on the modules of the type $\mathfrak{C}_{K/k}(I_1, I_2)$ and show the product of two such modules lies in some third one. We have also used this multiplication in the study of the decomposability of ideals in extensions of complete discrete valuation fields with inseparable residue field extension (cf. [BV]).

Starting from the second section we consider totally wildly ramified extensions of complete discrete valuation fields with residue field of characteristic p with the restriction on the different:

$$\mathfrak{D}_{K/k} = (\delta), \delta \in k \tag{*}$$

This second section is dedicated to the study of conditions ensuring that the ring of integers \mathfrak{D}_K is free over its associated order $\mathfrak{A}_{K/k}(\mathfrak{D}_K)$ or $\mathfrak{B}_{K/k}(\mathfrak{D}_K)$. Let $n = [K : k]$.

We prove the following statement.

PROPOSITION. *If in the associated order $\mathfrak{A}_{K/k}(\mathfrak{D}_K)$ ($\mathfrak{B}_{K/k}(\mathfrak{D}_K)$ resp.) there is an element ξ which maps some (and so, any) element $a \in \mathfrak{D}_K$ with valuation equal to $n - 1$ onto a prime element of the ring \mathfrak{D}_K , then $\mathfrak{D}_K \approx \mathfrak{A}_{K/k}$ (resp. $\mathfrak{B}_{K/k}$) and besides that $\mathfrak{A}_{K/k}$ (resp. $\mathfrak{B}_{K/k}$) has a "power" base (in the sense of multiplication $\overset{\Delta}{*}$, cf. the second section), which is constructed explicitly using the element ξ .*

The converse to this statement is also proved in the case when $\mathfrak{A}_{K/k}(\mathfrak{D}_K)$ (resp. $\mathfrak{B}_{K/k}(\mathfrak{D}_K)$) is indecomposable (cf. the Theorems 2.4.1, 2.4.2). An important part of our reasoning is due to Byott (cf. [By1]).

0.3. The third, fourth and fifth sections are dedicated to proving a more explicit form of the condition of the second section for the Abelian case. The main result of the paper is the following one. We will call an Abelian p -extension of complete discrete valuation fields of characteristic 0 *almost maximally ramified* if its degree divides the different.

THEOREM A. *Let K/k be an Abelian totally ramified p -extension of p -adic fields, which in case $\text{char } k = 0$ is not almost maximally ramified, and suppose that the different of the extension is generated by an element in the base field (see (*)). Then the following conditions are equivalent:*

1. *The extension K/k is Kummer for a formal group F , that there exists a formal group F over the ring of integers \mathfrak{o} of the field k , a finite torsion subgroup T of the formal module $F(\mathfrak{M}_{\mathfrak{o}})$ and a prime element π_0 of k such that $K = k(x)$, where x is a root of the equation $P(X) = \pi_0$, where*

$$P(X) = \prod_{t \in T} (X - t)_F .$$

2. *The ring \mathfrak{D}_K is isomorphic to the associated order $\mathfrak{A}_{K/k}(\mathfrak{D}_K)$ as an $\mathfrak{o}[G]$ -module.*

Remark 0.3.1. Besides proving Theorem A we will also construct the element ξ explicitly and so describe $\mathfrak{A}_{K/k}(\mathfrak{D}_K)$ (cf. the theorems of §2).

Remark 0.3.2. IF k is of characteristic 0 the fact that \mathfrak{D}_K is indecomposable as an $\mathfrak{o}[G]$ -module if and only if K/k is not almost maximally ramified, was proved in [BVZ]. The case of almost maximally ramified extensions is well understood (cf., for example, [Be]). It is obvious, that in the case $\text{char } k = p$ the ring \mathfrak{D}_K is indecomposable as an $\mathfrak{o}[G]$ -module, because in this case the algebra $k[G]$ is indecomposable.

Remark 0.3.3. In the paper [CM] rings of integers in Kummer extensions for formal groups are also studied as modules over their associated orders. In that paper Kummer extensions are defined with the use of homomorphisms of formal groups. For extensions obtained in this way freeness of the ring of integers over its associated orders is proved. Childs and Moss also use some tensor product to prove their results. Yet their methods seem to be inapplicable for proving inverse results.

Our notion of a Kummer extension for a formal group is essentially equivalent to the one in [CM]. We however only use one formal group and do not impose finiteness restriction on its height.

Besides we consider also the equal characteristic case i.e., $\text{char } k = \text{char } \bar{k} = p$. Using the methods presented here one can prove that we can actually take the formal group F in Theorem A of finite height. Yet such a restriction does not seem to be natural.

Remark 0.3.4. Theorem A shows which Hopf orders can be associated to Galois orders for some Abelian extensions. The papers of mathematicians that “tame wild extensions by Hopf orders” do not show that their authors know or guess that such an assertion is valid.

In the third section we study the fields that are Kummer in the sense of part 1 of Theorem A and deduce 2 from 1. In the fourth section we prove that we can suppose the coefficient b_1 in $\xi = \delta^{-1} \sum b_{\sigma} \sigma$ to be equal to 0. Further, if

b_1 is equal to 0, then we show that there exists a formal group F over \mathfrak{o} , such that for $\sigma \in G$ the b_σ , form a torsion subgroup in the formal module $F(\mathfrak{M}_\mathfrak{o})$, i.e.,

$$b_\sigma \underset{F}{+} b_\tau = b_{\sigma\tau} .$$

In the fifth section we prove that if $b_\sigma \underset{F}{+} b_\tau$ is indeed equal to $b_{\sigma\tau}$, then K/k is Kummer for the group F .

0.4. This paper is the first in a series of papers devoted to associated orders and associated modules. The technique introduced in this paper (especially the map ϕ and the multiplication $*$ defined below) turns out to be very useful in studying The Galois structure of ideals. It allows the author to prove in another paper some results about freeness of ideals over their associated orders in extensions that do not fulfill the condition on the different (*). In particular, using Kummer extensions for formal groups we construct a wide variety of extensions in which some ideals are free over their associated orders. These examples are completely new. We also calculate explicitly the Galois structure of all ideals in such extensions. Such a result is very rare. In a large number of cases the necessary and sufficient condition for an ideal to be free over its associated order is found.

The author is deeply grateful to professor S. V. Vostokov for his help and advice.

The work paper is supported by the Russian Fundamental Research Foundation N 01-00-000140.

§1 GENERAL RESULTS

Let

\mathfrak{o} be a Dedekind ring,

k be the fraction field of the ring \mathfrak{o} ,

K/k be a Galois extension with Galois group equal to G ,

$\mathfrak{D} = \mathfrak{D}_{K/k}$ be the different of the extension K/k ,

$n = [K : k]$,

tr be the trace operator in K/k .

We also define some associated modules.

For I_1 and I_2 G -stable ideals in K put

$\mathfrak{B}_{K/k}(I_1, I_2) = \text{Hom}_{\mathfrak{o}[G]}(I_1, I_2)$. For I_1, I_2 not being G -stable one can define

$$\mathfrak{B}_{K/k}(I_1, I_2) = \{f \in \text{Hom}_{\mathfrak{o}[G]}(K, K), f(I_1) \subset I_2\}.$$

For arbitrary $I_1, I_2 \subset K$ we define

$$\mathfrak{A}_{K/k}(I_1, I_2) = \{f \in k[G] | f(I_1) \subset I_2\},$$

$$\mathfrak{C}_{K/k}(I_1, I_2) = \text{Hom}_{\mathfrak{o}}(I_1, I_2).$$

Obviously, any \mathfrak{o} -linear map from I_1 into I_2 can be extended to a k -linear homomorphism from K into K . The dimension of $\text{Hom}_k(K, K)$ over k is equal to n^2 . Now we consider the group algebra $K[G]$. This algebra acts on K and

the statement in (Bourbaki, algebra, §7, no. 5) implies that a non-zero element of $K[G]$ corresponds to a non-zero map from K into K . Besides the dimension of $K[G]$ over k is also equal to n^2 . It follows that any element of $\text{Hom}_k(K, K)$ can be expressed uniquely as an element of $K[G]$. So we reckon $\mathfrak{C}_{K/k}(I_1, I_2)$ being embedded in $K[G]$.

1.1. We consider the G -Galois algebra $K \otimes_k K$. It is easily seen that the tensor product $K \otimes_k K$ is isomorphic to a direct sum of n copies of K as a k -algebra. Being more precise, let K_σ , $\sigma \in G$ denote a field, isomorphic to K .

LEMMA 1.1.1. *There is an isomorphism of K -algebras*

$$\psi : K \otimes_k K \rightarrow \sum_{\sigma \in G} K_\sigma,$$

where $\psi = \sum_{\sigma} \psi_{\sigma}$ and ψ_{σ} is the projection on the coordinate σ , defined by the equality

$$\psi_{\sigma}(x \otimes y) = x\sigma(y) \in K_{\sigma}.$$

The proof is quite easy, you can find it, for example, in "Algebra" of Bourbaki. Also see 1.2 below.

Now we construct a map ϕ from the G -Galois algebra $K \otimes_k K$ into the group algebra $K[G]$:

$$\begin{aligned} \phi : K \otimes_k K &\rightarrow K[G] \\ (1) \quad \alpha = \sum_i x_i \otimes y_i &\rightarrow \phi(\alpha) = \sum_i x_i \left(\sum_{\sigma \in G} \sigma(y_i) \sigma \right). \end{aligned}$$

It is clear that $\phi(\alpha)$ as a function acts on K as follows:

$$(2) \quad \phi(\alpha)(z) = \sum_i x_i \text{tr}(y_i z), \quad z \in K.$$

Besides that, the map ϕ may be expressed through ψ_{σ} in the form

$$(3) \quad \phi(\alpha) = \sum_{\sigma} \psi_{\sigma}(\alpha) \sigma, \quad \alpha \in K \otimes_k K.$$

PROPOSITION 1.1.2. *The map ϕ is an isomorphism of k -vector spaces between $K \otimes_k K$ and $K[G]$.*

Cf. the sketch of the proof in Remark 1.2 below.

1.2 PAIRINGS ON $K \otimes_k K$ AND $K[G]$.

There is a natural isomorphism of the k -space K and its dual space of k -functionals:

$$\begin{aligned} K &\rightarrow \widehat{K} \\ a &\rightarrow f_a(b) = \text{tr}(ab). \end{aligned}$$

We define a pairing $\langle \cdot, \cdot \rangle_{\otimes}$ on $K \otimes_k K$, that takes its values in k :

$$(K \otimes_k K) \times (K \otimes_k K) \rightarrow k$$

$$\langle a \otimes b, c \otimes d \rangle_{\otimes} \rightarrow (f_a \otimes f_c)(b \otimes d) = (\text{tr } ac)(\text{tr } bd).$$

This pairing is correctly defined and is non-degenerate. The second fact is easily proved with the use of dual bases.

We also define a pairing on $K[G]$ that takes its values in k :

$$K[G] \times K[G] \rightarrow k$$

$$\alpha = \sum_{\sigma} a_{\sigma} \sigma, \beta = \sum_{\sigma} b_{\sigma} \sigma \rightarrow \sum_{\sigma} \text{tr } a_{\sigma} b_{\sigma} = \langle \alpha, \beta \rangle_{K[G]}.$$

The pairing $\langle \cdot, \cdot \rangle_{K[G]}$ is also non-degenerate because it is a direct sum of $n = [K : k]$ non-degenerate pairings

$$K \times K \rightarrow k$$

$$(a, b) \rightarrow \text{tr } ab.$$

We check that for any two x, y the following equality is fulfilled:

$$(4) \quad \langle x, y \rangle_{\otimes} = \langle \phi(x), \phi(y) \rangle_{K[G]}.$$

Indeed, it follows from linearity that it is sufficient to prove that for $x = a \otimes b, y = c \otimes d$. In that case we have

$$\langle a \otimes b, c \otimes d \rangle_{\otimes} = \text{tr } ac \text{tr } bd,$$

and besides that

$$\begin{aligned} & \langle \phi(a \otimes b), \phi(c \otimes d) \rangle_{K[G]} \\ &= \langle a \sum_{\sigma} \sigma(b) \sigma, c \sum_{\sigma} \sigma(d) \sigma \rangle_{K[G]} \\ &= \sum_{\sigma} \text{tr}(ac \sigma(bd)) = \sum_{\sigma} \sum_{\tau} \tau(ac \sigma(bd)) \\ &= \sum_{\tau} \sum_{\sigma} \tau(ac) \tau \sigma(bd) = \text{tr } ac \text{tr } bd. \end{aligned}$$

and the equality (4) is proved.

Remark 1.2. It follows from (4) that the map ϕ from (1) is an injection. Indeed, let $\phi(\alpha)$ be equal to 0 for $\alpha \in K \otimes_k K$, then $\langle \phi(\alpha), \phi(\beta) \rangle_{K[G]} = 0$ for any $\beta \in K \otimes_k K$. So, according to (4), $\langle \alpha, \beta \rangle_{\otimes} = 0$ for any $\beta \in K \otimes_k K$. From the non-degeneracy of the pairing $\langle \cdot, \cdot \rangle_{\otimes}$ it follows that $\alpha = 0$. That implies $\text{Ker}(\phi) = 0$.

Using the equality of dimensions we can deduce that ϕ is an isomorphism.

1.3 MODULES OF HOMOMORPHISMS FOR A PAIR OF IDEALS.

Let I_1, I_2 be fractional ideals of the field K .

THEOREM 1.3.1. *Let ϕ be the bijection from (1) and let $I_1^* = \mathfrak{D}^{-1}I_1^{-1}$ (this is dual of I_1 for the bilinear trace form on K). For the associated modules the following equality holds:*

$$\mathfrak{C}_{K/k}(I_1, I_2) = \phi(I_2 \otimes_{\mathfrak{o}} I_1^*).$$

Proof. First we show that $\phi(I_2 \otimes_{\mathfrak{o}} I_1^*) \subset \mathfrak{C}_{K/k}(I_1, I_2)$. If $x \in I_2$, $y \in I_1^*$, then for any $z \in I_1$ we have, according to the definition (2):

$$\phi(x \otimes y)(z) = x \operatorname{tr}(yz) \in I_2,$$

since $x \in I_2$ and $\operatorname{tr}(yz) \in \mathfrak{o}$, which follows from the definition of I_1^* and of the different \mathfrak{D} .

Conversely, let $f \in \mathfrak{C}_{K/k}(I_1, I_2)$. We define a map θ_f and show that it is sent onto f by ϕ . Let:

$$(5) \quad \begin{aligned} \theta_f : I_2^* \otimes_{\mathfrak{o}} I_1 &\rightarrow \mathfrak{o} \\ x \otimes y &\rightarrow \operatorname{tr}(xf(y)). \end{aligned}$$

This map is correctly defined since $x \in I_2^* = \mathfrak{D}^{-1}I_2^{-1}$ and $f(y) \in I_2$, thus

$$\operatorname{tr}(xf(y)) \in \mathfrak{o}.$$

For a \mathfrak{o} -module M we denote by \widehat{M} the module of \mathfrak{o} -linear functions from M into \mathfrak{o} . It is clear that

$$(6) \quad \theta_f \in (\widehat{I_2^* \otimes_{\mathfrak{o}} I_1}).$$

We identify the ideal I_2 with the \mathfrak{o} -module $\widehat{I_2^*}$ via:

$$\begin{aligned} I_2 &\rightarrow \widehat{I_2^*} \\ a &\rightarrow f_a = \sum_{\sigma \in G} \sigma(a)\sigma. \end{aligned}$$

Obviously $f_a(z) = \operatorname{tr}(az)$ for any $z \in \widehat{I_2^*}$.

In a completely analogous way we identify I_1^* with $\widehat{I_1}$.

Using these identifications and the fact that I_1 and I_2^* are projective \mathfrak{o} -modules we obtain an isomorphism

$$(7) \quad \begin{aligned} I_2 \otimes_{\mathfrak{o}} I_1^* &\rightarrow (\widehat{I_2^* \otimes_{\mathfrak{o}} I_1}) \\ a \otimes b &\rightarrow h_{a,b}, \end{aligned}$$

where $h_{a,b}(x \otimes y) = \langle a \otimes b, x \otimes y \rangle_{\otimes} = (\text{tr } ax)(\text{tr } by)$ for all x in I_2^* and y in I_1 . The map θ_f in (5) lies in $(I_2^* \otimes_{\sigma} I_1)$ (cf. (6)), and so, according to the isomorphism (7), it corresponds to an element α_f in $I_2 \otimes_{\sigma} I_1^*$, i.e.,

$$\alpha_f = \sum_i a_i \otimes b_i, \quad a_i \in I_2, \quad b_i \in I_1^*.$$

Then (7) implies that the functional h_{α_f} , that corresponds to the element α_f , is defined in the following way:

$$h_{\alpha_f}(x \otimes y) = \langle \alpha_f, x \otimes y \rangle_{\otimes} = \sum_i \text{tr } a_i x \text{tr } b_i y.$$

On the other hand, from the definition of θ_f (cf. (5)) we obtain:

$$h_{\alpha_f}(x \otimes y) = \theta_f(x \otimes y) = \text{tr}(xf(y)).$$

It follows that $f(y) = \sum_i a_i \text{tr}(b_i y)$. So we have

$$f = \phi\left(\sum a_i \otimes b_i\right),$$

and for any f in $\mathfrak{C}_{K/k}(I_1, I_2)$ we have found its preimage in $I_2 \otimes I_1^*$, i.e.,

$$\mathfrak{C}_{K/k}(I_1, I_2) \subset \phi(I_2 \otimes_{\sigma} I_1^*).$$

The theorem is proved. \square

Remark 1.3.2. In the same way as above we can prove, that if we replace the ideals I_1, I_2 by two arbitrary free σ -submodules X and Y of K of dimension n , then we will obtain the following formula:

$$\mathfrak{C}_{K/k}(X, Y) = \phi(Y \otimes \widehat{X}),$$

where \widehat{X} is the dual module to X in K with respect to the pairing $K \times K \rightarrow k$ defined by the trace tr .

Remark 1.3.3. All elements in $\mathfrak{C}_{K/k}(I_1, I_2)$, $\mathfrak{A}_{K/k}(I_1, I_2)$, $\mathfrak{B}_{K/k}(I_1, I_2)$ have unique extensions to k -linear maps from K to K . To be more precise, if $f : I_1 \rightarrow I_2$ is an σ -homomorphism, then for all $x \in K$ we can assume $f(x) = \alpha f(a)$ if $x = \alpha a$, $\alpha \in k$, $a \in I_1$. It is easily seen that the map we obtained in this way is a correctly defined k -linear homomorphism from K into K .

1.4. Now we compare the modules \mathfrak{A} and \mathfrak{B} .

PROPOSITION 1.4.

$$(8) \quad \mathfrak{A}_{K/k}(I_1, I_2) = \mathfrak{B}_{K/k}(I_1, I_2)$$

if and only if K/k is an Abelian extension.

Proof. 1. Let K/k be an Abelian extension. To verify the equality (8) in this case, let first f belong to $\mathfrak{A}_{K/k}(I_1, I_2)$, then f is an \mathfrak{o} -homomorphism from I_1 into I_2 . Besides that, f commutes with all elements of G since G is an Abelian group, i.e., $\sigma f(a) = f(\sigma(a))$ for all $\sigma \in G$ and $a \in I_1$. So we obtain that f is an $\mathfrak{o}[G]$ -homomorphism from I_1 into I_2 , thus $f \in \mathfrak{B}_{K/k}(I_1, I_2)$.

For the reverse inclusion, let f belong to $\mathfrak{B}_{K/k}(I_1, I_2)$. Then f induces an $\mathfrak{o}[G]$ -homomorphism from K into K . We take an element x that generates a normal base of the field K over k . Then there exists an element $g \in k[G]$ such that $f(x) = g(x)$, to be more precise, if $f(x) = \sum_{\sigma} a_{\sigma} \sigma(x)$, $a_{\sigma} \in k$ then we take $g = \sum a_{\sigma} \sigma$. We consider the $\mathfrak{o}[G]$ -homomorphism g from K into K . Since G is an Abelian group, $f(\sigma(x)) = \sigma(f(x)) = \sigma(g(x)) = g(\sigma(x))$ for any $\sigma \in G$. We obtain that k -homomorphisms f and g coincide on the basic elements and so $f = g \in k[G]$ and $f(I_1) \subset I_2$, i.e., $f \in \mathfrak{A}_{K/k}(I_1, I_2)$.

2. Now we suppose that $\mathfrak{A}_{K/k}(I_1, I_2) = \mathfrak{B}_{K/k}(I_1, I_2)$ and check that K/k is an Abelian extension. Indeed, since $k\mathfrak{A}_{K/k}(I_1, I_2) = k[G]$, $\mathfrak{A}_{K/k}(I_1, I_2)$ contains elements of the form $a\sigma$, where $a \in k^*$, for any $\sigma \in G$. It follows from our assumption that $a\sigma \in \mathfrak{B}_{K/k}(I_1, I_2)$, and so $a\sigma$ is an $\mathfrak{o}[G]$ -homomorphism. We obtain that G commutes with all elements $\sigma \in G$. Proposition is proved. \square

PROPOSITION 1.5. *If we assume the action of G on $K \otimes_k K$ to be diagonal, then*

$$\mathfrak{B}_{K/k}(I_1, I_2) = \phi((I_2 \otimes_{\mathfrak{o}} I_1^*)^G).$$

Proof. Let α belong to $(I_2 \otimes_{\mathfrak{o}} I_1^*)^G$. We have to show that $\phi(a)$ is an $\mathfrak{o}[G]$ -homomorphism from I_1 into I_2 . This means that

$$\sigma\phi(a)(z) = \phi(a)(\sigma(z))$$

for all $z \in I_1$. Let α be equal to $\sum a_i \otimes b_i$, $a_i \in I_2$, $b_i \in I_1^*$. Then from the definition of ϕ (cf. (2)) it follows that

$$\begin{aligned} \phi(a)(\sigma(z)) &= \sum_i a_i \operatorname{tr}(b_i \sigma(z)) \\ &= \sum_i a_i \operatorname{tr}(\sigma^{-1}(b_i) \sigma(z)) = \phi \left(\sum_i a_i \otimes \sigma^{-1}(b_i) \right) (z). \end{aligned}$$

On the other hand,

$$\begin{aligned} \sigma\phi(a)(z) &= \sigma \left(\sum_i a_i \operatorname{tr}(b_i z) \right) \\ &= \sum_i (\sigma(a_i) \operatorname{tr}(b_i z)) = \phi \left(\sum_i \sigma(a_i) \otimes b_i \right) (z). \end{aligned}$$

From the G -invariance of the element α it follows that

$$\phi\left(\sum a_i \otimes \sigma^{-1}(b_i)\right) = \phi\left(\sum \sigma(a_i) \otimes \sigma(\sigma^{-1}(b_i))\right) = \phi\left(\sum \sigma(a_i) \otimes b_i\right).$$

Thus $\phi(\alpha)(\sigma(z)) = \sigma\phi(\alpha)(z)$ for any $\sigma \in G$, i.e., $\phi(\alpha) \in \mathfrak{B}_{K/k}(I_1, I_2)$. Conversely, let f belong to $\mathfrak{B}_{K/k}(I_1, I_2)$, then $f \in \mathfrak{C}_{K/k}(I_1, I_2)$ and so, according to Theorem 1.3.1, there is an $\alpha \in I_2 \otimes I_1^*$, such that $f = \phi(\alpha)$. It remains to check that α is G -invariant. We use the fact that f is an G -homomorphism, i.e., $\sigma f(z) = f(\sigma z)$ for all $\sigma \in G$ and $z \in I_1$. We obtain an equality $\sigma\phi(\alpha)(z) = \phi(\alpha)(\sigma z)$. By writing the left and the right side of the equality as above we obtain for $\alpha = \sum a_i \otimes b_i$:

$$\begin{aligned} \sigma\phi(\alpha)(z) &= \phi\left(\sum \sigma a_i \otimes \sigma(\sigma^{-1}b_i)\right)(z) \\ \phi(\alpha)(\sigma z) &= \phi\left(\sum a_i \otimes \sigma^{-1}b_i\right)(z). \end{aligned}$$

It follows that

$$\phi\left(\sum \sigma a_i \otimes \sigma(\sigma^{-1}b_i)\right) = \phi\left(\sum a_i \otimes \sigma^{-1}b_i\right).$$

Now using the fact that ϕ is a bijection we obtain

$$\sum \sigma a_i \otimes \sigma(\sigma^{-1}b_i) = \sum a_i \otimes \sigma^{-1}b_i.$$

We apply to both sides of the equality the map

$$\begin{aligned} 1 \otimes \sigma : K \otimes_k K &\rightarrow K \otimes_k K \\ a \otimes b &\rightarrow a \otimes \sigma(b) \end{aligned} ,$$

that obviously is an homomorphism. We have

$$\sum \sigma a_i \otimes \sigma b_i = \sum a_i \otimes b_i,$$

i.e., $\sigma(\alpha) = \alpha$. \square

1.6 THE MULTIPLICATION $*$ ON $K[G]$.

On the algebra $K \otimes_k K$ there is a natural multiplication: $(a \otimes b) \cdot (c \otimes d) = ac \otimes bd$. Using it and the bijection ϕ we define a multiplication on $K[G]$. To be more precise, if $f, g \in K[G]$, then we define

$$f * g = \phi(\phi^{-1}(f) \cdot \phi^{-1}(g)) \in K[G]. \tag{9}$$

PROPOSITION 1.6.1. *If $f = \sum_{\sigma} a_{\sigma}\sigma$ and $g = \sum_{\sigma} b_{\sigma}\sigma$, then*

$$f * g = \sum_{\sigma} a_{\sigma}b_{\sigma}\sigma.$$

Proof. Let f be equal to $\phi(\alpha)$, g be equal to $\phi(\beta)$, where $\alpha, \beta \in K \otimes_k K$. If $\alpha = \sum x_i \otimes y_i$, $\beta = \sum u_j \otimes v_j$, then from the definition of ϕ (cf. (1)) we obtain

$$\phi(\alpha) = \sum x_i \sum_{\sigma} \sigma y_i \sigma, \quad \phi(\beta) = \sum u_j \sum_{\sigma} \sigma v_j \sigma.$$

It follows that

$$\sum_{\sigma} a_{\sigma}b_{\sigma}\sigma = \sum_{i,j} x_i u_j \sigma(y_i v_j) \sigma.$$

On the other hand,

$$f * g = \phi(\alpha\beta) = \phi\left(\sum_{i,j} (x_i u_i \otimes y_i v_j)\right) = \sum_{i,j} x_i u_j \sigma(y_i v_j) \sigma$$

and we obtain the proof of Proposition. \square

Remark 1.6.2. The formula from Proposition 1.6.1 will be used further as an another definition of the multiplication $*$.

1.7 MULTIPLICATION ON ASSOCIATED MODULES.

Now we consider the multiplication (9) on the different associated modules. Here we will see appearing the different which we will suppose to be induced from the base field in the following sections.

PROPOSITION 1.7.1. *Let f belong to $\mathfrak{C}_{K/k}(I_1, I_2)$, and let g belong to $\mathfrak{C}_{K/k}(I_3, I_4)$. Then*

$$f * g \in \mathfrak{C}_{K/k}(I_1 I_3 \mathfrak{D}, I_2 I_4).$$

Proof. It is clear that $\phi^{-1}(f)$ and $\phi^{-1}(g)$ belong to $I_2 \otimes_o I_1^*$ and $I_4 \otimes I_3^*$ respectively. So we obtain that $\phi^{-1}(f)\phi^{-1}(g)$ lies in the product

$$\begin{aligned} (I_2 \otimes_o I_1^*)(I_4 \otimes_o I_3^*) &= I_2 I_4 \otimes_o (I_1^* I_3^*) \\ &= I_2 I_4 \otimes_o \mathfrak{D}^{-2} I_1^{-1} I_3^{-1} = I_2 I_4 \otimes_o (\mathfrak{D} I_1 I_3)^*. \end{aligned}$$

So from the Theorem 1.3.1 it follows that $f * g$ belongs to $\mathfrak{C}_{K/k}(I_1 I_3 \mathfrak{D}, I_2 I_4)$. \square

Now we study the multiplication $*$ on the modules $\mathfrak{B}_{K/k}$.

PROPOSITION 1.7.2. *Let f belong to $\mathfrak{B}_{K/k}(I_1, I_2)$ and let g belong to $\mathfrak{B}_{K/k}(I_3, I_4)$, then*

$$f * g \in \mathfrak{B}_{K/k}(I_1 I_3 \mathfrak{D}, I_2 I_4).$$

Proof. Since $\mathfrak{B}_{K/k}(I, J)$ is a submodule in $\mathfrak{C}_{K/k}(I, J)$, from Proposition 1.7 it follows that $f * g \in \mathfrak{C}_{K/k}(I_1 I_3 \mathfrak{D}, I_2 I_4)$. From Proposition 1.5 we deduce that f and g belong to $\phi(K \otimes_k K^G)$, $g \in \phi(K \otimes_k K^G)$. So $f * g \in \phi(K \otimes_k K^G)$, and this implies that

$$f * g \in \mathfrak{C}_{K/k}(I_1 I_3 \mathfrak{D}, I_2 I_4) \cap \phi(K \otimes_k K^G) = \mathfrak{B}_{K/k}(I_1 I_3 \mathfrak{D}, I_2 I_4).$$

□

PROPOSITION 1.7.3. *Let f belong to $\mathfrak{A}_{K/k}(I_1, I_2)$ and LET g belong to $\mathfrak{A}_{K/k}(I_3, I_4)$, then*

$$f * g \in \mathfrak{A}_{K/k}(I_1 I_3 \mathfrak{D}, I_2 I_4).$$

Proof. From Proposition 1.7 it follows that

$$f * g \in \mathfrak{C}_{K/k}(I_1 I_3 \mathfrak{D}, I_2 I_4) \tag{10}$$

since $\mathfrak{A}_{K/k}(I_1, I_2)$ and $\mathfrak{A}_{K/k}(I_3, I_4)$ are submodules OF $\mathfrak{C}_{K/k}(I_1, I_2)$ and $\mathfrak{C}_{K/k}(I_3, I_4)$ respectively. From the definition of $\mathfrak{A}_{K/k}$ it follows that f and g belong to $k[G]$. So the coefficients of f and g lie in k , and from Proposition 1.6.1 it follows that $f * g$ also belongs to $k[G]$. Then (10) implies that

$$f * g \in \mathfrak{C}_{K/k}(I_1 I_3 \mathfrak{D}, I_2 I_4) \cap k[G] = \mathfrak{A}_{K/k}(I_1 I_3 \mathfrak{D}, I_2 I_4),$$

and thus the proposition is proved. □

§2 ISOMORPHISM OF RINGS OF INTEGERS OF TOTALLY
WILDLY RAMIFIED EXTENSIONS OF COMPLETE DISCRETE
VALUATION FIELDS WITH THEIR ASSOCIATED ORDERS.

2.1. Let K/k be a totally wildly ramified Galois extension of a complete discrete valuation field with residue field of characteristic p . Let \mathfrak{D} be the different of the extension and let \mathfrak{D}_K be the ring of integers of the field K . From this moment and up to the end of the paper we will suppose the condition (*) of the introduction to be fulfilled, i.e., that $\mathfrak{D} = (\delta)$, with $\delta \in k$. We will write $\mathfrak{A}_{K/k}(\mathfrak{D}_K)$, $\mathfrak{B}_{K/k}(\mathfrak{D}_K)$ instead of $\mathfrak{A}_{K/k}(\mathfrak{D}_K, \mathfrak{D}_K)$, $\mathfrak{B}_{K/k}(\mathfrak{D}_K, \mathfrak{D}_K)$. We denote prime elements of the fields k and K by π_0 and π respectively, and their maximal ideals by \mathfrak{M}_0 and \mathfrak{M} .

PROPOSITION 2.1. *The modules $\mathfrak{C}_{K/k}(\mathfrak{D}_K)$, $\mathfrak{A}_{K/k}(\mathfrak{D}_K)$, $\mathfrak{B}_{K/k}(\mathfrak{D}_K)$ are \mathfrak{o} -algebras with a unit with respect to the multiplication*

$$f \overset{\Delta}{*} g = \delta f * g = \delta^{-1} \phi(\phi^{-1}(\delta f) \phi^{-1}(\delta g))$$

(cf. (9)). *The unit is given by $\delta^{-1} \text{tr}$.*

The motivation for the above definition is given by Theorem 2.4.1 below.

Proof. Let f and g belong to $\mathfrak{C}_{K/k}(\mathfrak{D}_K)$, then according to Proposition 1.7, the product $f * g$ maps the different \mathfrak{D} into the ring \mathfrak{D}_K . It follows that $f \overset{\Delta}{*} g$ maps \mathfrak{D} into \mathfrak{D} , and so it also maps \mathfrak{o} into itself since $\mathfrak{D} = \delta \mathfrak{D}_K$. We obtain that $\overset{\Delta}{*}$ defines a multiplication on the each of the modules associated to \mathfrak{D}_K . Now we consider the element $\delta^{-1} \text{tr}$ and prove that it is the unit for the multiplication $\overset{\Delta}{*}$ in each of these modules. It is clear that $\delta^{-1} \text{tr}$ maps \mathfrak{D}_K into itself and that $\delta^{-1} \text{tr}$ belongs to $k[G]$, so $\delta^{-1} \text{tr}$ belongs to $\mathfrak{A}_{K/k}(\mathfrak{D}_K)$. Besides that, $\delta^{-1} \text{tr}$ commutes with all elements of G and so $\delta^{-1} \text{tr}$ lies in $\mathfrak{B}_{K/k}(\mathfrak{D}_K)$.

Let now f belong to $K[G]$, then

$$f = \sum_{\sigma} a_{\sigma} \sigma, \quad a_{\sigma} \in K, \quad \delta^{-1} \text{tr} = \sum_{\sigma} \delta^{-1} \sigma.$$

So, according to proposition 1.6.1,

$$f * (\delta^{-1} \text{tr}) = \sum_{\sigma} \delta^{-1} a_{\sigma} \sigma$$

and we obtain

$$f \overset{\Delta}{*} (\delta^{-1} \text{tr}) = \sum a_{\sigma} = f.$$

Since $\mathfrak{A}_{K/k}(\mathfrak{D}_K), \mathfrak{B}_{K/k}(\mathfrak{D}_K)$ are \mathfrak{o} -submodules in $\mathfrak{C}_{K/k}(\mathfrak{D}_K)$, $\delta^{-1} \text{tr} \in \mathfrak{A}_{K/k}(\mathfrak{D}_K), \mathfrak{B}_{K/k}(\mathfrak{D}_K)$, $\delta^{-1} \text{tr}$ is also an identity in $\mathfrak{A}_{K/k}(\mathfrak{D}_K), \mathfrak{B}_{K/k}(\mathfrak{D}_K)$ with respect to the multiplication $\overset{\Delta}{*}$.

2.2. Let as before n be equal to $[K : k]$.

LEMMA 2.2.1. *Let x be an element of the ring \mathfrak{D}_K whose valuation equals $n - 1$, i.e., $v_K(x) = n - 1$. Then*

$$v_k(\text{tr } x) = v_k(\delta).$$

In particular, there is an element a in \mathfrak{D}_K with $v_K(a) = n - 1$ and such that $\text{tr } a = \delta$.

Proof. Let \mathfrak{M} and $\mathfrak{M}_{\mathfrak{o}}$ be the maximal ideals of K and k respectively. From the definition of the different and surjectivity of the trace operator it follows that $\text{tr}(\mathfrak{M}^{-1} \mathfrak{D}^{-1}) = \mathfrak{M}_{\mathfrak{o}}^{-1}$. Moreover any element of $\mathfrak{M}^{-1} \mathfrak{D}^{-1}$, that does not belong to \mathfrak{D}^{-1} , has a non-integral trace. So the trace of the element $z = \pi_0^{-1} \delta^{-1} x$ is equal to

$$\text{tr } z = \pi_0^{-1} \delta^{-1} \text{tr } x = \pi_0^{-1} \varepsilon, \quad \varepsilon \in \mathfrak{o}^*.$$

Thus $\text{tr } x = \varepsilon \delta$. Further, if we multiply the element x by $\varepsilon^{-1} \in \mathfrak{o}^*$, then we get the element a . \square

LEMMA 2.2.2. *In the ring \mathfrak{D}_K we can choose a basis $a_0, a_1, \dots, a_{n-2}, a$, where a is as in Lemma 2.2.1, and the a_i for $0 \leq i \leq n-2$ are such that $v_K(a_i) = i$, and satisfy $\text{tr } a_i = 0$.*

Proof. The kernel $\text{Ker tr}(\mathfrak{D}_K)$ has \mathfrak{o} -rank equal to $n-1$. Let x_0, \dots, x_{n-2} be an \mathfrak{o} -basis of $\text{Ker tr}(\mathfrak{D}_K)$. Along with the element a they form a \mathfrak{o} -base of the ring \mathfrak{D}_K . By elementary operations in $\text{Ker tr}(\mathfrak{D}_K)$ we can get from x_0, \dots, x_{n-2} a set of elements with pairwise different valuations. Their valuations have to be less than $n-1$. Indeed, otherwise by subtracting from the element x_0 of valuation $n-1$ an element a of the same valuation multiplied by a coefficient in \mathfrak{o}^* we can obtain an element of \mathfrak{M}^n , which is impossible. \square

2.3. Let a be an element of \mathfrak{D}_K with valuation equal to $n-1$, where $n = [K : k]$, and let

$$\text{tr } a = \delta, \tag{12}$$

where δ is a generator of the different $\mathfrak{D}_{K/k}$ (cf. Lemma 2.2.1).

PROPOSITION 2.3.1. 1. *The module $\mathfrak{A}_{K/k}(\mathfrak{D}_K)(a) \bmod \mathfrak{M}^n$ is a subring with an identity in $\mathfrak{D}_K \bmod \mathfrak{M}^n$ (with standard multiplication).*

2. *The multiplication $\overset{\Delta}{*}$ in $\mathfrak{A}_{K/k}(\mathfrak{D}_K)$ (cf. (11)) induces the standard multiplication in the ring $\mathfrak{A}_{K/k}(\mathfrak{D}_K)(a) \bmod \mathfrak{M}^n$, i.e.,*

$$f \overset{\Delta}{*} g(a) \equiv f(a)g(a) \bmod \mathfrak{M}^n.$$

Proof. Let f and g belong to $\mathfrak{A}_{K/k}(\mathfrak{D}_K)$. Then the preimages $\phi^{-1}(\delta f)$, $\phi^{-1}(\delta g)$ with respect to the bijection ϕ belong to $\mathfrak{D}_K \otimes_{\mathfrak{o}} \mathfrak{D}_K$, since

$$\mathfrak{D} \otimes_{\mathfrak{o}} \mathfrak{D}^{-1} = \delta \mathfrak{D}_K \otimes_{\mathfrak{o}} \delta^{-1} \mathfrak{D}_K = \mathfrak{D}_K \otimes_{\mathfrak{o}} \mathfrak{D}_K.$$

We prove that

$$\phi^{-1}(\delta a) = x \otimes 1 + y, \tag{13}$$

where $x \in \mathfrak{D}_K$ and $y \in \mathfrak{D}_K \otimes \mathfrak{M}$.

Indeed, $\phi^{-1}(\delta a) = \sum a_i \otimes b_i$. If $b_i \in \mathfrak{M}$, then $a_i \otimes b_i \in \mathfrak{D}_K \otimes \mathfrak{M}$, otherwise $b_i = c_i + d_i$, where $c_i \in \mathfrak{o}$, $d_i \in \mathfrak{M}$ and so $a_i \otimes b_i = a_i \otimes c_i + a_i \otimes d_i = c_i x_i \otimes 1 + y_i$, where $c_i x_i \in \mathfrak{D}_K$, since $c_i \in \mathfrak{o}$ and $y_i \in \mathfrak{D}_K \otimes \mathfrak{M}$. So (13) follows.

Similarly

$$\phi^{-1}(\delta g) = x' \otimes 1 + y', \tag{14}$$

where $x' \in \mathfrak{D}_K$, $y' \in \mathfrak{D}_K \otimes \mathfrak{M}$.

Thus

$$\begin{aligned} \phi^{-1}(\delta f)\phi^{-1}(\delta g) &= (x \otimes 1 + y)(x' \otimes 1 + y') \\ &= xx' \otimes 1 + y((x' \otimes 1) + y') + (x \otimes 1)y' \\ &= xx' \otimes 1 + z, \text{ where } z \in \mathfrak{D}_K \otimes \mathfrak{M}. \end{aligned} \tag{15}$$

We consider the action of the element $f \in \mathfrak{A}_{K/k}(\mathfrak{D}_K)$ on the element a with valuation equal to $n - 1$. From (13) we obtain $f = \delta^{-1}\phi(x \otimes 1 + y)$, where $x \in \mathfrak{D}_K$, $y \in \mathfrak{D}_K \otimes \mathfrak{M}$. Then from the definition of the map ϕ we have:

$$\begin{aligned} f(a) &= \delta^{-1}\phi(x \otimes 1 + y)(a) \\ &= \delta^{-1}(\phi(x \otimes 1)(a) + \phi(y)(a)) \\ &= \delta^{-1}x \operatorname{tr} a + \delta^{-1}\phi(y)(a). \end{aligned}$$

We show that $\delta^{-1}\phi(y)(a) \in \mathfrak{M}^n$,
i.e.,

$$f(a) = \delta^{-1}x \operatorname{tr} a + z, \text{ where } z \in \mathfrak{M}^n. \quad (16)$$

Indeed, let y be equal to $\sum a_i \otimes b_i$, then from the definition of ϕ we deduce that

$$\phi(y)(a) = \sum a_i \operatorname{tr}(b_i a).$$

Moreover $\operatorname{tr} b_i a \in \mathfrak{DM}_0$, thus $\delta^{-1}a_i \operatorname{tr}(b_i a) \in \mathfrak{M}^n$, i.e., $z = \delta^{-1}\phi(y)(a) \in \mathfrak{M}^n$ and we obtain (16).

Our assumptions imply that $\operatorname{tr} a = \delta$, so

$$f(a) \equiv x \pmod{\mathfrak{M}^n}$$

and similarly

$$g(a) \equiv x' \pmod{\mathfrak{M}^n},$$

where x' is the element from (14). Then

$$f(a)g(a) \equiv xx' \pmod{\mathfrak{M}^n}.$$

On the other hand from the definition of the multiplication $f \overset{\Delta}{*} g$ (cf. (11)) it follows that

$$f \overset{\Delta}{*} g(a) = \delta^{-1}\phi(\phi^{-1}(\delta f)\phi^{-1}(\delta g))(a).$$

Using this and keeping in mind (15) and (16) we obtain

$$f \overset{\Delta}{*} g(a) = \delta^{-1}\phi(xx' \otimes 1 + z)(a) \equiv xx' \pmod{\mathfrak{M}^n}.$$

So we have the congruence

$$f \overset{\Delta}{*} g(a) \equiv f(a)g(a) \pmod{\mathfrak{M}^n}.$$

Also, the element $\delta^{-1} \operatorname{tr}$ in $\mathfrak{A}_{K/k}(\mathfrak{D}_K)$ gives us an identity element in the ring $\mathfrak{A}_{K/k}(\mathfrak{D}_K)(a) \pmod{\mathfrak{M}^n}$, since $\delta^{-1} \operatorname{tr} a = 1$ (cf. (12)). \square

Remark 2.3.2. For any other element a' in the ring \mathfrak{D}_K with valuation equal to $n - 1$ we have $\mathfrak{A}_{K/k}(\mathfrak{D}_K)(a') \equiv \varepsilon \mathfrak{A}_{K/k}(\mathfrak{D}_K)(a) \pmod{\mathfrak{M}^n}$, $\varepsilon \in \mathfrak{o}^*$.

Remark 2.3.3. A similar statement also holds for the module $\mathfrak{B}_{K/k}(\mathfrak{D}_K)(a) \pmod{\mathfrak{M}^n}$.

2.4. Now we formulate the statements which we will begin to prove in the next subsection.

We will investigate the following condition:
in the order $\mathfrak{A}_{K/k}(\mathfrak{D}_K)$ (resp. $\mathfrak{B}_{K/k}(\mathfrak{D}_K)$) there exists an element ξ such that

$$\xi(a) = \pi, \tag{17}$$

where π is a prime element of the field K and a is some element with valuation equal to $n - 1$.

THEOREM 2.4.1. *If in the ring $\mathfrak{A}_{K/k}(\mathfrak{D}_K)$ (resp. $\mathfrak{B}_{K/k}(\mathfrak{D}_K)$) the condition (17) is fulfilled, then the element ξ generates a "power" basis of $\mathfrak{A}_{K/k}(\mathfrak{D}_K)$ ($\mathfrak{B}_{K/k}(\mathfrak{D}_K)$ resp.) over \mathfrak{o} with respect to the multiplication $\overset{\Delta}{*}$ (cf. 11), i.e.,*

$$\mathfrak{A}_{K/k}(\mathfrak{D}_K) = \langle \xi^0, \xi^1, \dots, \xi^{n-1} \rangle,$$

where $\xi^0 = \delta^{-1} \text{tr}$ is the unit and $\xi^i = \xi \overset{\Delta}{*} \xi^{i-1}$.

THEOREM 2.4.2. 1. *If for the ring $\mathfrak{A}_{K/k}(\mathfrak{D}_K)$ (resp. $\mathfrak{B}_{K/k}(\mathfrak{D}_K)$) the condition (17) is fulfilled, then the ring \mathfrak{D}_K is a free $\mathfrak{A}_{K/k}(\mathfrak{D}_K)$ -module (resp. free $\mathfrak{B}_{K/k}(\mathfrak{D}_K)$ -module).*

2. *If the ring \mathfrak{D}_K is a free module over the ring $\mathfrak{A}_{K/k}(\mathfrak{D}_K)$ (resp. $\mathfrak{B}_{K/k}(\mathfrak{D}_K)$) and if moreover the order $\mathfrak{A}_{K/k}(\mathfrak{D}_K)$ (resp. $\mathfrak{B}_{K/k}(\mathfrak{D}_K)$) is indecomposable (i.e. does not contain non-trivial idempotents), then for the ring $\mathfrak{A}_{K/k}(\mathfrak{D}_K)$ (resp. $\mathfrak{B}_{K/k}(\mathfrak{D}_K)$) the condition (17) and so also the assertions of the theorem 2.4.1 are fulfilled.*

Remark 2.4.3. If ξ maps some element with valuation equal to $n - 1$ onto an element with valuation equal to 1, then ξ also maps any other element with valuation equal to $n - 1$ onto an element with valuation equal to 1.

Indeed, if $a \in K$, $v_k(a) = n - 1$ and $v_K(\xi(a)) = 1$, then any other element $a' \in \mathfrak{D}_K$, for which $v_K(a') = n - 1$, is equal to $\varepsilon a + b$, where $\varepsilon \in \mathfrak{o}^*$, $b \in \mathfrak{M}^n$, so $b = \pi_0 b'$, where π_0 is a prime element in k . Besides that $b' \in \mathfrak{D}_K$ and we obtain $\xi(b) = \pi_0 \xi(b')$ and this implies $v_K(\xi(b)) \geq n$.

We also have $v_K(\xi(\varepsilon a)) = v_K(\varepsilon \xi(a)) = v_K(\varepsilon) + 1 = 1$ i.e., $\varepsilon \in \mathfrak{o}^*$, and so $v_K(\xi(a')) = 1$.

Remark 2.4.4. Any element ξ in $\mathfrak{A}_{K/k}(\mathfrak{D}_K)$ (resp. in $\mathfrak{B}_{K/k}(\mathfrak{D}_K)$) that fulfills the condition (17) generates a power base of the \mathfrak{o} -module $\mathfrak{A}_{K/k}(\mathfrak{D}_K)$ (resp. $\mathfrak{B}_{K/k}(\mathfrak{D}_K)$) with respect to the multiplication $\overset{\Delta}{*}$.

2.5 PROOF OF THEOREM 2.4.1 AND OF THE FIRST PART OF THEOREM 2.4.2..

We take the element a in the ring \mathfrak{D}_K such that $v_K(a) = n - 1$ and $\text{tr } a = \delta$ (cf. (12)). By assumption we have $\xi(a) = \pi$, where π is a prime element of the field K . We check that

$$\xi^i(a) \equiv \pi^i \pmod{\mathfrak{M}_K^n}. \tag{18}$$

Indeed, if $i = 0$, then for the usual product $\xi^0(a)\delta^{-1}\text{tr}(a) = 1$. Let further $\xi^{i-1}(a)$ be equal to $\pi^{i-1} \pmod{\mathfrak{M}_K^n}$, then according to Proposition 2.3.1 we have

$$\pi^i \equiv \xi^{i-1}(a)\xi(a) \equiv (\xi^{i-1} \overset{\Delta}{*} \xi)(a) \equiv \xi^i(a) \pmod{\mathfrak{M}_K^n}$$

and the congruence (18) is proved. This equality implies that $\xi^i(a)$, $0 \leq i \leq n - 1$, generate \mathfrak{D}_K , i.e., $\mathfrak{D}_K = \mathfrak{o}\xi^0(a) \oplus \dots \oplus \mathfrak{o}\xi^{n-1}(a)$. Now we show that

$$\mathfrak{A}_{K/k}(\mathfrak{D}_K) = \langle \xi^0, \dots, \xi^{n-1} \rangle.$$

If there exists an element $\eta \in \mathfrak{A}_{K/k}(\mathfrak{D}_K)$ that does not belong to a \mathfrak{o} -module $\langle \xi^0, \dots, \xi^{n-1} \rangle$, then $\eta(a) = b \in \mathfrak{D}_K$. So we obtain

$$\eta(a) = \sum_{i=0}^{n-1} \alpha_i \xi^i(a), \quad \alpha_i \in \mathfrak{o},$$

i.e.,

$$(\eta - \sum \alpha_i \xi^i)(a) = 0 \tag{19}$$

Now we show that

$$\eta = \sum \alpha_i \xi^i. \tag{20}$$

Indeed the spaces $k\mathfrak{A}_{K/k}(\mathfrak{D}_K)$ and $k\langle \xi^0, \dots, \xi^{n-1} \rangle$ have equal dimensions and so coincide. It follows from (19) that

$$\eta - \sum \alpha_i \xi^i \in \mathfrak{A}_{K/k}(\mathfrak{D}_K) \subset k\mathfrak{A}_{K/k}(\mathfrak{D}_K) = k\langle \xi^0, \dots, \xi^{n-1} \rangle,$$

and so

$$\eta - \sum \alpha_i \xi^i = \sum_{i=0}^{n-1} \alpha'_i \xi^i,$$

where $\alpha'_i \in k$. Since $\alpha'_i \in k$ and the valuations of the elements $\xi^i(a)$, $0 \leq i \leq n - 1$ are pairwise non-congruent \pmod{n} (cf. (16)), the valuations $v_K((\alpha'_i \xi^i)(a))$ are also pairwise non-congruent \pmod{n} , and so $\sum \alpha'_i \xi^i(a) \neq 0$ if not all the α'_i are equal to 0. This reasoning proves (20).

So we have obtained that the ring \mathfrak{D}_K is a free $\mathfrak{A}_{K/k}(\mathfrak{D}_K)$ -module:

$$\mathfrak{D}_K = \mathfrak{A}_{K/k}(\mathfrak{D}_K)(a)$$

and we have proved Theorem 2.4.1 and the first part of Theorem 2.4.2.

LEMMA 2.6. *Let x be an element of the ring \mathfrak{D}_K such that $\text{tr } x = 0$, then for any $f \in \mathfrak{A}_{K/k}(\mathfrak{D}_K)$ and $g \in \mathfrak{B}_{K/k}(\mathfrak{D}_K)$ the following equalities hold:*

$$\text{tr } f(x) = 0 = \text{tr } g(x) = 0.$$

Proof. If $f \in \mathfrak{A}_{K/k}(\mathfrak{D}_K)$, then $f = \sum_{\sigma \in G} a_\sigma \sigma$, $a_\sigma \in k$, and so

$$\text{tr } f(x) = \text{tr}(\sum a_\sigma \sigma(x)) = \sum a_\sigma \text{tr } \sigma(x) = 0.$$

If $g \in \mathfrak{B}_{K/k}(\mathfrak{D}_K)$, then $\text{tr } g(x) = g(\text{tr}(x)) = g(0) = 0$, since g is an $\mathfrak{o}[G]$ -homomorphism. \square

2.7. PROOF OF NECESSITY IN THEOREM 2.4.2.

Let \mathfrak{D}_K be a free $\mathfrak{A}_{K/k}(\mathfrak{D}_K)$ -module and assume the order $\mathfrak{A}_{K/k}(\mathfrak{D}_K)$ IS indecomposable. We prove that in the order $\mathfrak{A}_{K/k}(\mathfrak{D}_K)$ there exists an element ξ that fulfills the condition (17) of 2.4. We take elements a_0, \dots, a_{n-2} such that $v_K(a_i) = i$ and such that $\text{tr } a_i = 0$ (cf. Lemma 2.2.2 and also [By1]). We take further an element a with valuation equal to $n - 1$. Let $\chi : \mathfrak{D}_K \rightarrow \mathfrak{A}_{K/k}(\mathfrak{D}_K)$ be an isomorphism of $\mathfrak{o}[G]$ -modules, then

$$\mathfrak{A}_{K/k}(\mathfrak{D}_K) = \langle \chi(a_0), \dots, \chi(a) \rangle_{\mathfrak{o}}.$$

Thus, in particular, there exist $\alpha_i, \alpha \in \mathfrak{o}$ such that

$$1 = \alpha_0 \chi(a_0) + \dots + \alpha_{n-2} + \alpha \chi(a).$$

The ring $\mathfrak{A}_{K/k}(\mathfrak{D}_K)$ is indecomposable by assumption, and so, according to the Krull-Schmidt Theorem, it is a local ring. We obtain that one of the $\chi(a_i)$ OR $\chi(a)$ has to be invertible in the ring $\mathfrak{A}_{K/k}(\mathfrak{D}_K)$. The elements $\chi(a_i)$ cannot be invertible since, according to Lemma 2.6, $\mathfrak{A}_{K/k}(\mathfrak{D}_K)(a_i) \in \text{Ker tr } \mathfrak{D}_K$. Thus $\chi(a)$ is invertible and it follows that $\mathfrak{A}_{K/k}(\mathfrak{D}_K)(a) = \mathfrak{D}_K$. We obtain that there exists a ξ in $\mathfrak{A}_{K/k}(\mathfrak{D}_K)$ such that $\xi(a) = \pi$. Theorem 2.4.2 is proved.

Remark 2.7. The corresponding reasoning for the ring $\mathfrak{B}_{K/k}(\mathfrak{D}_K)$ almost literally repeats the one we used above.

§3 KUMMER EXTENSIONS FOR FORMAL GROUPS.
THE PROOF OF SUFFICIENCY IN THEOREM A.

Starting from this section we assume that the extension K/k is Abelian.

3.1. We denote the valuation on k by v_0 . We also denote by v_0 the valuation on K that coincides with v_0 on k .

We suppose that the field k fulfills the conditions of §2 and that F is some formal group over the ring \mathfrak{o} (the coefficients of the series $F(X, Y)$ may, generally speaking, lie, for example, in the ring of integers of some smaller field). On the maximal ideal $\mathfrak{M}_{\mathfrak{o}}$ of the ring \mathfrak{o} we introduce a structure of a formal \mathbb{Z}_p -module using the formal group F by letting for $x, y \in \mathfrak{M}_{\mathfrak{o}}$ and $\alpha \in \mathbb{Z}_p$

$$\begin{aligned} x \underset{F}{+} y &= F(x, y), \\ \alpha x &= [\alpha](x). \end{aligned}$$

We denote the \mathbb{Z}_p -module obtained in this way by $F(\mathfrak{M}_{\mathfrak{o}})$. Let T be a finite torsion subgroup in $F(\mathfrak{M}_{\mathfrak{o}})$ and let $n = \text{card } T$ be the cardinality of the group T . Obviously, n is a power of p .

We construct the following series:

$$P(X) = \prod_{t \in T} (X \underset{F}{-} t). \tag{21}$$

Remark 3.1.1. The constant term of the series $P(X)$ is equal to zero, the coefficient at X^n is invertible in \mathfrak{o} , and the coefficients at the powers, not equal to n , belong to the ideal $\mathfrak{M}_{\mathfrak{o}}$.

LEMMA 3.1.2. *Let a be a prime element of the field k and $K = k(x)$ be the extension obtained from k by adjoining the roots of the equation $P(X) = a$, where the series P is as in (21). Then the extension K/k is a totally ramified Abelian extension of degree n and the different \mathfrak{D} of the extension K/k is generated by an element of the base field, i.e., $\mathfrak{D} = (\delta)$, $\delta \in k$. The ramification jumps of the extension K/k are equal to $h_l = nv_0(t_l) - 1$, $t_l \in T$.*

Proof. Using the Weierstrass Preparation Lemma we decompose the series $P(X) - a$ into a product

$$P(X) - a = cf(X)\varepsilon(X),$$

where $\varepsilon(X) \in \mathfrak{o}[[X]]^*$ is an invertible series (with respect to multiplication), $f(X)$ is a unitary polynomial, $c \in \mathfrak{o}$. Then, according to Remark 3.1.1, $f(X)$ is an Eisenstein polynomial of degree n . The series $P(X) - a$ has the same roots (we consider only the roots of $P(X) - a$ with positive valuation) as the polynomial $f(X)$, and so there are exactly n roots. It is obvious that if $P(x) = a$, then

$$P(x \underset{F}{+} \tau) = \prod_{t \in T} (x \underset{F}{-} t \underset{F}{+} \tau) = \prod_{t \in T} (x \underset{F}{-} t) = P(x) = a, \quad \tau \in T$$

and so the roots of $P(X) - a$ and $f(X)$ are exactly the elements $x \underset{F}{+} \tau$, $\tau \in T$.

Thus we proved that all roots of $f(X)$ lie in K and are all distinct. It follows that K/k is a Galois extension. We denote the Galois group of the extension K/k by G . Obviously if $\sigma_1, \sigma_2 \in G$, $\sigma_1(x) = x \underset{F}{+} t_1$, $\sigma_2(x) = x \underset{F}{+} t_2$, then $\sigma_2(\sigma_1(x)) = \sigma_2(x \underset{F}{+} t_1) = \sigma_2(x) \underset{F}{+} t_1 = x \underset{F}{+} t_2 \underset{F}{+} t_1$ (as $F(X, Y)$ is defined over \mathfrak{o} , $t_1 \in T$). Since the addition $\underset{F}{+}$ is commutative, the extension K/k is Abelian. We also have that $\prod \sigma(x) = a$, $v_k(a) = 1$, and so $v_0(x) = \frac{e(K/k)}{n}$. This implies that the extension K/k is totally ramified and that x is a prime element in K . Now we compute the ramification jumps of the extension K/k . Let $F(X, Y) = X + Y + \sum_{i, j > 0} a_{ij} X^i Y^j$ be the formal group law, then we have

$$x - \sigma_l(x) = x - (x \underset{F}{+} t_l) = t_l + \sum_{i, j > 0} a_{ij} x^i t_l^j = t_l \varepsilon_t,$$

where ε_t is a unit of the ring \mathfrak{D}_K . It follows that the ramification jumps of the extension K/k are equal to $nv_k(t_l) - 1$. Hence the exponent of the different is equal to $\sum_{t_l \in T} (h_l + 1) = n \sum_{t_l \in T} v_k(t_l)$ (cf., for example, [Se], Ch. 4, Proposition 4) and so $v_k(\mathfrak{D}) \equiv 0 \pmod{n}$. \square

3.2. Before beginning the proof of Theorem A we prove that the first condition of Theorem A is equivalent to a weaker one.

PROPOSITION 3.2. *Let a belong to \mathfrak{o} , $v_k(a) = ns + 1$, where $0 \leq s < \min_{t \in T} v_k(t)$. Then the extension $k(x)/k$, where x is A root of the equation $P(X) = a$, has the same properties as the extensions from the first condition of Theorem A.*

Proof. We consider the series

$$F_s(X, Y) = \pi_0^{-s} F(\pi_0^s X, \pi_0^s Y).$$

It is easily seen that F_s also defines a formal group law and the elements of $T_s = \{\pi_0^{-s}t, t \in T\}$ form some torsion subgroup in the formal module $F_s(\mathfrak{M}_\mathfrak{o})$. Indeed, if $F(X, Y) = \sum a_{ij} X^i Y^j$, then $F_s(X, Y) = \sum \pi_0^{s(i+j-1)} a_{ij} X^i Y^j$, and so the coefficients of $F_s(X, Y)$ are integral. Since $\pi_0^{-s} X + \pi_0^{-s} Y = \pi_0^{-s} (X + Y)$, F_s indeed defines an associative and commutative addition. Besides that if $u_1, u_2 \in T_s$, then $u_1 +_{F_s} u_2 = \pi_0^{-s} (\pi_0^s u_1 +_F \pi_0^s u_2) \in T_s$ and so T_s is indeed a subgroup in $F(\mathfrak{M}_\mathfrak{o})$.

Now we compute the series $P_{F_s}(X)$ for the formal group F_s . We obtain:

$$\begin{aligned} P_{F_s}(X) &= \prod_{t \in T} (X -_{F_s} \pi_0^{-s} t) = \prod_t (\pi_0^{-s} (\pi_0^s X) -_{F_s} \pi_0^{-s} t) \\ &= \prod_t \pi_0^{-s} (\pi_0^s X -_F t) = \pi_0^{-sn} P_F(\pi_0^s X). \end{aligned}$$

Thus the equation $P_f(X) = a$ is equivalent to $P_{F_s}(\pi_0^{-s} X) = a\pi_0^{-sn}$. Besides that $v(\pi_0^{-sn} a) = v(a) - sn$, i.e., $\pi_0^{-sn} a$ is a prime element in k .

Now it remains to note that a root of the equation $P_f(X) = a$ can be obtained by multiplication of a root of the equation $P_{F_s}(Y) = a\pi_0^{-sn}$ by π_0^s , and so the extensions obtained by adjoining the roots of these equations coincide. \square

3.3 THE PROOF OF THEOREM A: 1 \implies 2.

Let K/k be an extension obtained by adjoining the roots of the equation $P(X) = \pi_0$. So $K = k(x)$ for some root x . We consider the maximal ideal \mathfrak{M}_\otimes of the tensor product $\mathfrak{O}_K \otimes \mathfrak{O}_K$. Obviously $\mathfrak{M}_\otimes = \mathfrak{O}_K \otimes \mathfrak{M} + \mathfrak{M} \otimes \mathfrak{O}_K$. We also have $\mathfrak{M}_\otimes^i = \sum_{j=0}^i \mathfrak{M}^j \otimes \mathfrak{M}^{i-j}$, $i > 0$, and so it is easily seen that $\cap_{i>0} \mathfrak{M}_\otimes^i = 0$. It follows that we can introduce \mathbb{Z}_p -module structure $F(\mathfrak{M}_\otimes)$ on \mathfrak{M}_\otimes . We consider the element

$$\alpha = x \otimes 1 - 1 \otimes x \in \mathfrak{M}_\otimes .$$

We can define ξ in the following way:

$$\xi = \delta^{-1} \phi(\alpha). \tag{22}$$

We check the following properties of the element ξ :

1. $\xi \in \mathfrak{A}_{K/k}(\mathfrak{D}_K)$
2. If y belongs to \mathfrak{D}_K and $v(y) = n - 1$, then $\xi(y)$ is a prime element in K .

For (1):

Let $X \underset{F}{-} Y$ be equal to $\sum b_{ij} X^i Y^j$, then the equalities

$$\begin{aligned} \phi(\alpha) &= \sum b_{ij} \phi(x^i \otimes 1^i) * \phi(1^j \otimes x^j) \\ &= \sum_{\sigma \in G, i, j} b_{ij} x^i \sigma(x^j) \sigma = \sum (x \underset{F}{-} \sigma x) \sigma = \sum t_\sigma \sigma \in k[G] \end{aligned}$$

follow from the definitions of ϕ and $*$. It also follows from Theorem 1.3.1 that ξ belongs to $\mathfrak{C}_{K/k}(\mathfrak{D}_K)$. Thus $\xi \in k[G] \cap \mathfrak{C}_{K/k}(\mathfrak{D}_K) = \mathfrak{A}_{K/k}(\mathfrak{D}_K)$.

For (2):

It easily seen that

$$(x \otimes 1) \underset{F}{-} (1 \otimes x) = x \otimes 1 + y, \quad (23)$$

where $y \in \mathfrak{M} \otimes \mathfrak{M}$. Indeed,

$$x \otimes 1 \underset{F}{-} 1 \otimes x = x \otimes 1 + \sum_{i \geq 1, j \geq 0} b_{ij} x^i \otimes x^j.$$

Since $b_{ij} \in \mathfrak{o}$, $b_{ij} x^i \otimes x^j \in \mathfrak{D}_K \otimes \mathfrak{M}$ and we obtain (23).

We can assume that $\text{tr}(xa) = \delta$ (cf. Remark 2.4.3).

Then, as in Proposition 2.3.1, we have

$$\xi(a) = \delta^{-1} \phi(x \otimes 1 + y)(a) \equiv x \pmod{\mathfrak{M}^n}.$$

Since $v(x) = 1$, we have proved the property 2.

3.4. Now we construct explicitly a basis of an associated order for extensions that fulfill the condition 1 of Theorem A. We have proved above that we can take the element ξ to be equal to $\delta^{-1} \sum t_\sigma \sigma$. Then it follows from Theorem 2.4.1 that

$$\mathfrak{A}_{K/k}(\mathfrak{D}_K) = \langle \delta^{-1} \sum_{\sigma} t_\sigma^i \sigma, i = 0, \dots, n-1 \rangle.$$

Now suppose that K is generated by a root of the equation $P(X) = b$, where $v_k(b) = sn + 1$, $s < \min v_0(t_i)$. In 3.2 we proved that K may be generated by a root of the equation $P_s(X) = b\pi_0^{-sn}$, and so it follows in this case that

$$\mathfrak{A}_{K/k}(\mathfrak{D}_K) = \langle \delta^{-1} \pi_0^{-si} t_\sigma^i \sigma, i = 0, \dots, n-1 \rangle.$$

PROPOSITION 3.4.1. *Suppose that the extension K/k fulfills the condition 1 of Theorem A. Then $\mathfrak{A}_{K/k}(\mathfrak{O}_K)$ is a Hopf order in the group ring $k[G]$ with respect to the standard Hopf structure.*

Proof. $\mathfrak{A}_{K/k}(\mathfrak{O}_K)$ is an order in the group ring. It is easily seen, that if $f = \sum_{\sigma \in G} c_\sigma \sigma \in \mathfrak{A}_{K/k}(\mathfrak{O}_K)$, then $\sum c_\sigma \sigma^{-1} \in \mathfrak{A}_{K/k}(\mathfrak{O}_K)$. Indeed, we have $\phi^{-1}(f) \in \delta^{-1}\mathfrak{O}_K \otimes_o \mathfrak{O}_K$. Now consider the \mathfrak{o} -linear map $i : K \otimes_k K \rightarrow K \otimes_k K$, that maps $x \otimes y$ into $y \otimes x$. Obviously, $i(\phi^{-1}(f)) \in \delta^{-1}\mathfrak{O}_K \otimes_o \mathfrak{O}_K$. Besides, we have $\phi(x \otimes y) = \sum_{\sigma \in G} x\sigma(y)$, $\phi(y \otimes x) = \sum_{\sigma \in G} y\sigma(x) = \sum_{\sigma \in G} \sigma(x\sigma^{-1}(y))$. Thus we have

$$\sum c_\sigma \sigma^{-1} = \phi(i(\phi^{-1}(f))) \in \mathfrak{A}_{K/k}(\mathfrak{O}_K).$$

Thus it is sufficient to prove that for any $f \in \mathfrak{A}_{K/k}(\mathfrak{O}_K)$ we have

$$\Delta(f) \in \mathfrak{A}_{K/k}(\mathfrak{O}_K) \otimes \mathfrak{A}_{K/k}(\mathfrak{O}_K),$$

, where $\Delta(\sum c_\sigma \sigma) = \sum c_\sigma \sigma \otimes \sigma$. Theorem 2.4.1 implies immediately that it is sufficient to check this assertion for $f = \xi^l$, $l \geq 0$, the power is taken with respect to multiplication $\overset{\Delta}{*}$.

We consider the polynomial

$$J(X) = \prod_{t \in T \setminus \{0\}} \frac{t - X}{t}.$$

We have $J(0) = 1$, $J(t) = 0$ for $t \in T \setminus \{0\}$. The standard formula for the valuation of the different (cf. [Se]) and the last assertion of Lemma 3.1.2 imply that $J(X) \in \delta^{-1}\mathfrak{o}[X]$.

The fact that $\mathfrak{A}_{K/k}(\mathfrak{O}_K)$ is an \mathfrak{o} -algebra with a unit with respect to the multiplication $\overset{\Delta}{*}$ implies that for $f_1, f_2 \in \mathfrak{A}_{K/k}(\mathfrak{O}_K) \otimes \mathfrak{A}_{K/k}(\mathfrak{O}_K)$ their product $f_1 * f_2$ which is defined coefficient-wise lies in $\delta^{-2}\mathfrak{A}_{K/k}(\mathfrak{O}_K) \otimes \mathfrak{A}_{K/k}(\mathfrak{O}_K)$. Thus for the element $I = \sum_{\tau, \sigma \in G} t_{\sigma\tau^{-1}} \sigma\tau$ belongs to $\delta^2\mathfrak{A}_{K/k}(\mathfrak{O}_K) \otimes \mathfrak{A}_{K/k}(\mathfrak{O}_K)$ since

$$I = \sum_{\tau, \sigma \in G} (t_\sigma - t_\tau)_F = \delta^2 \sum_{i, j \geq 0} b_{ij} \xi^i \otimes \xi^j,$$

where the powers are taken with respect to $\overset{\Delta}{*}$ and b_{ij} are the coefficients in the expansion of the formal difference $X - Y$ into the powers of X and Y .

We also obtain that the element

$$L = \Delta(\text{tr}) = \sum_{\sigma \in G} \sigma \otimes \sigma = J(I)$$

belongs to $\delta\mathfrak{A}_{K/k}(\mathfrak{O}_K) \otimes \mathfrak{A}_{K/k}(\mathfrak{O}_K)$. Then we have the equality

$$\Delta(\xi^l) = (\xi^l \otimes \text{tr}) * L \in \mathfrak{A}_{K/k}(\mathfrak{O}_K) \otimes \mathfrak{A}_{K/k}(\mathfrak{O}_K)$$

since $\text{tr} \in \delta\mathfrak{A}_{K/k}(\mathfrak{O}_K)$. \square

In a future paper we will prove a similar statement for an extension that fulfills the second condition of Theorem A not supposing K/k to be Abelian.

§4 CONSTRUCTION OF A FORMAL GROUP

4.1. We suppose that in the associated order $\mathfrak{A}_{K/k}(\mathfrak{D}_K)$ there exists an element ξ such that it maps an element $a \in \mathfrak{D}_K$, $v_K(a) = n - 1$ into a prime element π of the field K , i.e.,

$$\xi(a) = \pi \quad (24)$$

(cf. Lemma 2.2.1 and Theorem 2.4.2). We choose an element a such that $\text{tr } a = \delta$ (cf. Lemma 2.2.1). Let

$$\begin{aligned} \psi_1 : K \otimes_k K &\rightarrow K \\ x \otimes y &\rightarrow xy \end{aligned} \quad (25)$$

be the map from 1.1, and let ϕ be the bijection between $K \otimes_k K$ and $K[G]$, that was defined in subsection 1.1.

LEMMA 4.1.1. *We can choose an element ξ in $\mathfrak{A}_{K/k}(\mathfrak{D}_K)$ fulfilling (4) so that*

1. $\phi^{-1}(\delta\xi) = \pi \otimes 1 - 1 \otimes \pi + z$, where z belongs to the maximal ideal \mathfrak{M} of the ring \mathfrak{D}_K .
2. In the expansion $\xi = \sum_{\sigma \in G} a_\sigma \sigma$, we have $a_1 = 0$ and $\delta a_\sigma \in \mathfrak{M}_\sigma$ for $\sigma \neq 1$, where \mathfrak{M}_σ is the maximal ideal in \mathfrak{o} .

Proof. Theorem 1.3.1 implies that the preimage $\phi^{-1}(\xi)$ belongs to $\mathfrak{D}_K \otimes \mathfrak{D}^{-1}$. From our assumptions we also have $\mathfrak{D} = (\delta)$, $\delta \in k$ (cf. (*)), so $\phi^{-1}(\delta\xi) \in \mathfrak{D}_K \otimes \mathfrak{D}_K$. As in 2.3, we can prove that

$$\phi^{-1}(\delta\xi) = x \otimes 1 + y,$$

where $x = \xi(a)\delta \text{tr}(a)^{-1} = \pi$, $y \in \mathfrak{D}_K \otimes \mathfrak{M}$. It follows that

$$\phi^{-1}(\delta\psi) = \pi \otimes 1 + y, \quad y \in \mathfrak{D}_K \otimes \mathfrak{M}.$$

We compute the coefficient at $1 = \text{id}_K$ of the element $\xi = \phi(\delta^{-1}(\pi \otimes 1 + y))$. From the definition of ϕ it follows that it is equal to $\psi_1(\delta^{-1}\alpha)$. We have

$$\psi_1(\delta^{-1}(\pi \otimes 1 + y)) = \delta^{-1}(\pi + \psi_1(y)). \quad (26)$$

We decompose the element y in the base of $\mathfrak{D}_K \otimes \mathfrak{M}$:

$$y = \sum_{i \geq 0, j \geq 1} a_{ij}(\pi^i \otimes \pi^j), \quad a_{ij} \in \mathfrak{o}.$$

Then

$$\psi_1\left(\sum a_{ij}\pi^i \otimes \pi^j\right) = \sum_{ij} a_{ij}\pi^{i+j} \quad (27)$$

If $\xi = \sum a_\sigma \sigma$, $a_\sigma \in k$, then $\psi_1(\delta^{-1}\alpha) = a_1 \in k$.

This implies that in order for the element (26) to lie in $\mathfrak{A}_{K/k}(\mathfrak{D}_K)$ it is necessary that the coefficient a_{01} in (27) is congruent with $-1 \pmod{\pi_0}$, where π_0 is the prime element of k . It follows that $y = -1 \otimes \pi + z$ where $z \in \mathfrak{M} \otimes \mathfrak{M}$. The first claim of the lemma is proved.

Now we consider

$$\xi' = \xi - \psi_1(\xi) \operatorname{tr} = \sum_{\sigma \in G} (a_\sigma - a_1)\sigma = \sum_{\sigma \in G, \sigma \neq 1} (a_\sigma - a_1)\sigma.$$

We have $\psi_1(\xi') = 0$. Besides that, $\delta a_1 = \pi + \sum a_{ij}\pi^{i+j}$, $a_1 \in k$, and it follows that $\delta a_1 \in \mathfrak{M}_\sigma$. Thus $a_1 \operatorname{tr} \in \mathfrak{M}_0 \mathfrak{A}_{K/k}(\mathfrak{D}_K)$, and it follows that $\xi' \in \mathfrak{A}_{K/k}(\mathfrak{D}_K)$ and $\xi'(a) \equiv \xi(a) \pmod{\mathfrak{M}^n}$. So ξ may be replaced by ξ' .

It remains to prove that in the expansion $\xi = \sum a_\sigma \sigma$ all δa_σ lie in \mathfrak{M} . From the definition of ψ_σ we have

$$\delta a_\sigma = \psi_\sigma(\delta \xi) = \psi_\sigma(\pi \otimes 1) = \psi_\sigma(1 \otimes \pi) + \psi_\sigma(z) = \pi - \sigma(\pi) + \psi_\sigma(z) \in \mathfrak{M} \tag{28}$$

since $z \in \mathfrak{M} \otimes \mathfrak{M}$. Yet $a_\sigma \in k$ and it follows that $a_\sigma \in \mathfrak{M} \cap k = \mathfrak{M}_\sigma$. \square

Corollary 4.1.2. We introduce the following notation: $\delta \xi = \sum_\sigma b_\sigma \sigma$. If $\phi^{-1}(\delta \xi) = \pi \otimes 1 - 1 \otimes \pi + \sum_{1 \leq i, j \leq n} a_{ij} \pi^i \otimes \pi^j$, $a_{ij} \in \mathfrak{o}$, then we have

$$b_\sigma = \pi - \sigma(\pi) + \sum a_{ij} \pi^i \sigma \pi^j \tag{29}$$

and

$$b_{\sigma^{-1}\tau} = \sigma\pi - \tau\pi + \sum a_{ij} \sigma \pi^i \tau \pi^j. \tag{30}$$

(the last statement follows from (29) and an obvious equality $\sigma b_{\sigma^{-1}\tau} = b_{\sigma^{-1}\tau}$).

4.2 A PRELIMINARY GROUP LAW.

We consider the expansion

$$\phi^{-1}(\delta \xi) = \pi \otimes 1 - 1 \otimes \pi + \sum_{1 \leq i, j < n} a_{ij} \pi^i \otimes \pi^j, \quad a_{ij} \in \mathfrak{o}. \tag{31}$$

We replace $\pi \otimes 1$ in this decomposition by X , and $1 \otimes \pi$ by Y and decompose $\pi^i \otimes \pi^j$ into the product $(\pi^i \otimes 1)(1 \otimes \pi^j)$. Then from the expansion (31) we obtain a polynomial in two variables of degree not greater than n ; we denote it by

$$R(X, Y) = X - Y + \sum_{1 \leq i, j \leq n} a_{ij} X^i Y^j, \quad a_{ij} \in \mathfrak{o}. \tag{32}$$

Now we identify $\pi \otimes 1$ with π , and $1 \otimes \pi$ with Z and obtain from (31) a polynomial in Z of degree not greater than n . We denote it by $s(Z)$:

$$s(Z) = \pi - Z + \sum_{1 \leq j \leq n} \left(\sum_{1 \leq i \leq n} a_{ij} \pi^i \right) Z^j. \tag{33}$$

All the coefficients of this polynomial except the coefficient at Z belong to \mathfrak{M} , and the coefficient at Z is invertible, so the polynomial $s(Z)$ is invertible in $\mathfrak{D}_K[[Z]]$ with respect to composition. We denote the inverse to s by $s^{-1}(Z)$. It follows from (28) and (31) that

$$b_\sigma = \delta a_\sigma = (\pi - \sigma(\pi)) + \sum_{1 \leq i, j \leq n} a_{ij} \pi^i \sigma \pi^j.$$

So, keeping in mind (33), we obtain

$$s(\sigma\pi) = b_\sigma, \quad s^{-1}(b_\sigma) = \sigma\pi.$$

Besides that, (32) and (30) imply:

$$G(b_\sigma, b_\tau) = R(s^{-1}(b_\sigma), s^{-1}(b_\tau)) = b_{\sigma^{-1}\tau},$$

we also know that the series $G(X, Y) = R(s^{-1}(X), s^{-1}(Y)) \in \mathfrak{D}_K[[X, Y]]$ and

$$G(b_\sigma, b_\tau) \equiv (b_\sigma - b_\tau) \pmod{\mathfrak{M}\mathfrak{D}_K[[X, Y]]}.$$

So the series $G(b_\sigma, b_\tau)$ is invertible with respect to composition as a series in b_τ . We denote this inverse series by $H(b_\sigma, b_\tau) \in \mathfrak{D}_K[[b_\sigma, b_\tau]]$. We also note that $H(b_\sigma, b_\tau) = b_{\sigma\tau}$.

We introduce the following notation:

$$M(X) = \prod_{\sigma \in G} (X - b_\sigma). \quad (34)$$

Consider the reduction of the series $H(X, Y)$ modulo the ideal $(M(X), M(Y))$. We obtain a polynomial $J(X, Y)$, whose degree in each variable is less than n . Since $M(b_\sigma) = 0$,

$$J(b_\sigma, b_\tau) = b_{\sigma\tau}. \quad (35)$$

PROPOSITION 4.2. $J(X, Y) \in \mathfrak{o}[[X, Y]]$.

Proof. We denote by $f(X, Y)$ the interpolation polynomial whose degree in each variable is less than n and that fulfills the system of relations

$$f(b_\sigma, b_\tau) = b_{\sigma\tau}, \quad \sigma, \tau \in G. \quad (36)$$

The polynomial J also fulfills the system of equalities (36) and so

$$f(X, Y) = J(X, Y).$$

Since $f \in k[X, Y]$, $J \in \mathfrak{D}_K[X, Y]$, the coefficients of J belong to $k \cap \mathfrak{D}_K = \mathfrak{o}$. \square

4.3 THE MAIN STATEMENT CONCERNING FINITE TORSION SUBMODULES OF FORMAL MODULES OVER FORMAL GROUPS.

Let G be an Abelian group and suppose that for any $\sigma \in G$ there is an element $b_\sigma \in \mathfrak{M}_\mathfrak{o}$ chosen, and suppose that $b_1 = 0$.

THEOREM 4.3.1. *The following conditions are equivalent*

- 1 *There exists a formal group $F(X, Y)$ over the ring of integers \mathfrak{o}_E of some extension E of the field k such that $b_\sigma + b_\tau = b_{\sigma\tau}$ for all $\sigma, \tau \in G$.*
2. *There exists a formal group $F(X, Y)$ over the ring \mathfrak{o} , fulfilling the same conditions: $b_\sigma + b_\tau = b_{\sigma\tau}$.*
3. *The coefficients of the interpolation polynomial $f(X, Y)$, of degree less than n in X and Y and such that for $\sigma, \tau \in G$*

$$f(b_\sigma, b_\tau) = b_{\sigma\tau}$$

belong to \mathfrak{o} .

Remark 4.3.2. This Theorem gives us a schematic description of finite subsets of $\mathfrak{M}_\mathfrak{o}$ that are finite groups with respect to an addition defined by some formal group with integral coefficients.

Additive Galois modules are not mentioned in the stating of this theorem and so it can be used without them.

Proof of Theorem 4.3.1: $2 \implies 1 \implies 3$. The condition 2 obviously implies 1. Now we prove that 1 implies 3. We consider the reduction of $F(X, Y)$ modulo the ideal $(M(X), M(Y))$ (cf. (34)) and denote it by $F_{\text{red}}(X, Y)$. It follows from the condition 1 that $F_{\text{red}}(b_\sigma, b_\tau) = b_{\sigma\tau}$, since $M(b_\sigma) = 0$. So $F_{\text{red}}(X, Y)$ coincides with the interpolation polynomial $f(X, Y)$, whose coefficients belong to k . Yet $F_{\text{red}}[X, Y] \in \mathfrak{o}_E[X, Y]$, so the coefficients of $f(X, Y)$ lie in $\mathfrak{o} = k \cap \mathfrak{o}_E$. It remains to prove that 3 implies 2.

4.4 SOME UNIVERSAL FORMAL GROUP LAWS.

We construct a formal group law in the same way as Hazewinkel (cf. [Ha], Ch. I, §3, subsection 3.1).

Consider the ring of polynomials $\mathbb{Z}_p[S_2, S_3, \dots, S_n] = \mathbb{Z}_p[S] \subset \mathbb{Q}_p[S]$. We introduce the following notation:

$$\sigma : \mathbb{Q}_p[S] \rightarrow \mathbb{Q}_p[S], S_i \rightarrow S_i^p.$$

We consider the series $f_S(X)$, whose coefficients are found from the equation

$$f_S(X) = g(X) + \sum_{i \geq 1} \frac{S_{p^i}}{p} \sigma_*^i f_S(X^{p^i}), \quad g(X) = X + \sum_{i \geq 2} S_i X^i - \sum_{i \geq 1} S_{p^i} X^{p^i},$$

where $\sigma_*^i f_S$ is the series obtained from f_S by applying the homomorphism σ^i to the coefficients, for $i > n$ we reckon S_i being equal to 0. It is easily seen that

$f_S = X + \sum_{i>1} a_i X^i$, $a_i \in Q[S]$. Then the Hazewinkel's Functional Equation Lemma implies that

$$F_S(X, Y) = f_S^{-1}(f_S(X) + f_S(Y))$$

is a formal group law over $\mathbb{Z}_p[S]$. Besides that

$$F_S[X, Y] \equiv X + Y + S_m v_p(m)^{-1} B_m(X, Y) \pmod{(S_2, \dots, S_{m-1}, \deg(m+1))}, \quad 2 \leq m \leq n, \quad (37)$$

where $v_p(m) = p$ if $m = p^r$, $r \in \mathbb{Z}$, $r > 0$, else $v_p(m) = 1$, and

$$B_m(X, Y) = X^m + Y^m - (X + Y)^m.$$

We note that the series F_S is a formal group law also in the case $\text{char } k = p$ (in that case we should compute the coefficients of $v_p(m)^{-1} B_m(X, Y)$ 'formally' in \mathbb{Z}). This formal group differs from Hazewinkel's only because $S_i = 0$ for $i > n$. Now we modify the formal group law we have obtained. To be more precise, we make the following change of variables.

Now we define some values r_m in the following way. Let r^m be equal to s if $m = p^s m_0$ and $(m_0, p) = 1$, $m_0 > 1$ or $m_0 = p$.

Then

$$F_S(X, Y) = X + Y + \sum_{2 \leq m \leq n} d_m X^{p^{r_m}} Y^{m-p^{r_m}} + \text{summands of other degrees.}$$

We consider the ring

$$\mathbb{Z}_p[V] = \mathbb{Z}_p[V_2, \dots, V_n], \quad V_i = d_i. \quad (38)$$

LEMMA 4.4. *We can express the variables S_i as polynomials in V_i with integral coefficients and so obtain a new formal group law over $\mathbb{Z}_p[V]$.*

Proof. We have the equality $V_2 = S_2$

Besides that, for $i > 2$ the equality $V_i = S_i + f_i(S_2, \dots, S_{i-1})$, $f_i \in \mathbb{Z}_p[S_2, \dots, S_{i-1}]$ is fulfilled (cf. (37)). It follows that we can express S_i as a polynomial in d_i, S_2, \dots, S_{i-1} with integral coefficients. Making all such changes we obtain an expression of S_i as a polynomial in V_2, \dots, V_{i-1} . Lemma is proved. \square

We note that the formal group law we constructed has the form

$$F_V(X, Y) = X + Y + \sum_{2 \leq m \leq n} V_m X^{p^{r_m}} Y^{m-p^{r_m}} + \text{summands of other degrees.} \quad (39)$$

4.5. In the Abelian group G we choose a family of subgroups $1 = G_0 \subset G_1 \subset G_2 \subset \dots \subset G_l = G$, where $n = p^l$ and the cardinality of G_i is equal to p^i . In each subgroup G_i we choose an element $\sigma_{p^{i-1}}$ such that the coset $\sigma_{p^{i-1}} \bmod G_{i-1}$ generates the cyclic group G_i/G_{i-1} of cardinality p . We obtain a set of generators $\sigma_1, \sigma_p, \dots, \sigma_{p^{l-1}}$ for the group G . By induction on the cardinality of G it can be easily proved that any element σ of G can be expressed uniquely in the form

$$\sigma = \prod_{0 \leq i \leq l-1} \sigma_{p^i}^{c_i}, \text{ where } 0 \leq c_i \leq p - 1. \tag{40}$$

We introduce the following notation:

$$c_\sigma = c_0 + pc_1 + \dots + p^{l-1}c_{l-1} \in \mathbb{Z}, \quad 0 \leq c_\sigma \leq n - 1.$$

We obtain a one-to-one correspondence $\sigma \rightarrow c_\sigma$. We also use the inverse notation: $\sigma_c = \sigma \iff c = c_\sigma$. We will construct the desired formal group by induction. On the m -th step we 'get rid' of the variable V_m and adjoin the m -th relation.

First we prove a simple lemma about relations in an arbitrary Abelian group.

LEMMA 4.5. *Let H be an Abelian group, f be a map from G into H , $f(1) = 1_H$. Then the following statements are fulfilled*

1. *If the relation*

$$f(\sigma_i)f(\sigma_j) = f(\sigma_i\sigma_j) \tag{41}$$

is fulfilled for all $i = p^{r_s}, j = s - p^{r_s}, 2 \leq s \leq m$, then it is also fulfilled for $0 \leq i \leq p^{r_m} - 1, 0 \leq j \leq m - 1$ and for $i = p^{r_m}, 0 \leq j \leq m - p^{r_m} - 1$.

2. *If (41) is fulfilled for $i = p^{r_s}, j = s - p^{r_s}, 2 \leq s \leq n$, then it is also fulfilled for all $0 \leq i < n, 0 \leq j < n$.*

Proof. 1. First we prove by induction that (41) is fulfilled for $0 \leq i \leq p^t, 0 \leq j \leq m - 1$, for all $0 \leq t \leq r_m$, i.e the restriction f_t of f onto G_t is a group homomorphism and $F_{tx} = \{f_i = f(\sigma_i), i = p^t x + u, 0 \leq u \leq p^t - 1\}, 0 < x < \frac{m}{p^t}$ are cosets modulo the subgroup $F_t = f(G_t)$.

This is fulfilled for $t = 0$ since $f(1_G) = 1_H$.

We suppose that such statement is fulfilled for $t = w$. Now we prove it for $t = w + 1$. Since F_{wx} are cosets modulo the subgroup F_w , it is sufficient to check that (41) is fulfilled for $i = p^w a, j = p^w b, 0 < a \leq p - 1, 0 < b < \frac{m}{p^w}$. If $0 < b \leq p$, then $r_{bp^w} = w$, and so for $i = (b - 1)p^w, j = p^w$ the relation (41) is fulfilled. Thus we obtain

$$f_{bp^w} = f_{p^w}^b, \quad b < p, \quad f_{(p-1)p^w} f_{p^w} = f_{p^w} = f(\sigma_{p^w}^p)$$

and f_{w+1} is a group homomorphism. Besides that, for $b > p, (b, p) = 1$ we also have $r_{bp^w} = w$, and so $f_{(b-1)p^w} f_{p^w} = f_{bp^w}$. For $b = pc$ we have:

$$f_{(pc-1)p^w} f_{p^w} = f_{(pc-p)p^w} f_{p^w}^p = f(\sigma_{(pc-1)p^w} \sigma_{p^w}^p),$$

since $\sigma_{p^w}^p \in G_w$. It follows that (41) is fulfilled indeed for all $i = p^w a, j = p^w b, 0 < a \leq p - 1, 0 < b < \frac{m}{p^w}$, and so $F_{w+1x}, 0 < x < \frac{m}{p^{w+1}}$ indeed form cosets modulo F_{w+1} .

The relation (41) for $i = p^w, w = r_m, 0 \leq j \leq m - p^w - 1$ is also sufficient to prove for $j = p^w b$, since F_{wx} are cosets modulo F_w . We argue in the same way as in the previous reasoning. We have again the equality $r_{bp^w} = w$ for $0 < b \leq p$. It follows that if $\frac{m}{p^w} \leq p$, then we obtain the desired assumption. If $\frac{m}{p^w} > p$, then for $\frac{m}{p^w} \geq b > p, (b, p) = 1$ also $r_{bp^w} = w$, and so $f_{(b-1)p^w} f_{p^w} = f(\sigma_{(b-1)p^w} \sigma_{p^w})$. For $p \mid b$ this is also fulfilled as $f_{(p-1)p^w} = f_{p^w}^{p-1}$. It follows that for $pc + p - 1 < \frac{m}{p^w}$ we have

$$f_{(pc+p-1)p^w} f_{p^w} = f_{pc} f_{p^w}^p = f(\sigma_{(pc+p-1)p^w} \sigma_{p^w}),$$

since $\sigma_{p^w}^p \in G_w$.

2. In the proof of the first part from the relation (41) for $i = p^{r_s}, j = s - p^{r_s}, 2 \leq s \leq m$ we deduced that $F_t, p^t \mid m$ is a group homomorphism, the same proof for $m = n$ gives us the desired statement. \square

4.6 THE PROOF OF 3 \implies 2 IN THEOREM 4.3.1.

In the beginning we are in the following situation. We have a formal group $F_V(X, Y)$, for which the following relations are fulfilled: $F(b_1, b_\sigma) = b_\sigma$ for all $\sigma \in G$, since $b_1 = 0$ from our assumptions.

We describe the second step.

We take the generator σ_1 of the group G_1 and try to fit the relation

$$F_V(b_{\sigma_1}, b_{\sigma_1}) = b_{\sigma_1}^2. \tag{42}$$

The interpolation polynomial $f(X, Y)$ from our condition 3 can be written in the form $f(X, Y) = X + Y + XY\psi(X, Y)$, where $\psi(X, Y) \in \mathfrak{o}[X, Y]$. We denote the ring of all series in $\mathfrak{o}[[V_i]]$, that converge at all (integral) values of V_i , by $\tilde{\mathfrak{o}}[[V_i]]$, and its ideal, consisting of series with coefficients in \mathfrak{M}_σ , by $\tilde{\mathfrak{M}}_\sigma[[V_i]]$. We have $b_{\sigma_1}^2 = b_{\sigma_1} + b_{\sigma_1} + b_{\sigma_1}^2 c, c \in \mathfrak{o}$. On the other hand, if the relation (42) is fulfilled, then

$$b_{\sigma_1}^2 = b_{\sigma_1} +_F b_{\sigma_1} = b_{\sigma_1} + b_{\sigma_1} + b_{\sigma_1}^2 V_2 + b_{\sigma_1}^3 (\dots), (\dots) \in \tilde{\mathfrak{o}}[[V_2, V_3, \dots, V_n]].$$

We obtain

$$V_2 + b_{\sigma_1} (\dots) = \text{const} \in \mathfrak{o}$$

where $(\dots) \in \tilde{\mathfrak{o}}[[V_2, V_3, \dots, V_n]]$. Using the last relation we express V_2 in V_3, \dots, V_n , i.e., $V_2 = c + g(V_3, V_4, \dots, V_n), g \in \tilde{\mathfrak{M}}_\sigma[[V_3, \dots, V_n]]$. This is possible, since in this relation the coefficient at the first power of V_2 is invertible, and coefficients at all other powers contain b_{σ_1} . We denote the formal group we obtained in this way by $F_V^2(X, Y)$. It depends on variables V_3, \dots, V_n and fits the relations:

$$F_V^2(b_1, b_\sigma) = b_\sigma, \sigma \in G$$

$$F_V^2(b_{\sigma_1}, b_{\sigma_1}) = b_{\sigma_1}^2.$$

The second step is ended.

Now we describe the m -th step. We suppose that at the $m - 1$ -step we obtained a formal group $F_V^{m-1}(X, Y)$ that depends on the variables V_m, V_{m+1}, \dots, V_n and fits the relations:

$$b_{\sigma_i} \underset{F}{+} b_{\sigma_j} = b_{\sigma_i \sigma_j} \tag{43}$$

for $0 \leq i \leq p^{r_m} - 1, 0 \leq j \leq m - 1$ and $i = p^{r_m}, 0 \leq j \leq m - p^{r_m} - 1$.

Thus we have $(m - 1)(p^{r_m} + 1) + 1$ relations.

We denote by A_{m-1} the set of points $(b_{\sigma_i}, b_{\sigma_j})$ in (43). We need some lemma about interpolation. We introduce the following notation:

$$\chi_{m-1} = F_V^{m-1}(X, Y) - f(X, Y), \tag{44}$$

where $f(X, Y)$ is an interpolation polynomial from the formula (36). The relations for $f(X, Y)$ imply that $\chi_{m-1}(b_{\sigma_i}, b_{\sigma_j}) = 0$ for the indices (i, j) mentioned in (43).

LEMMA 4.6.1. *Let R be an integral domain, b_{σ_i} be a set of elements in R , I be an ideal in $R[X, Y]$, consisting of all polynomials that take the value zero at all pairs $(b_{\sigma_i}, b_{\sigma_j})$ in A_{m-1} . Then $I = (M, N, L)$, where $M = \prod_{0 \leq i \leq p^{r_m}} (X - b_i)$, $N = \prod_{0 \leq j \leq m-1} (Y - b_{\sigma_j})$, $L = \prod_{0 \leq i \leq p^{r_m}-1} (X - b_i) \prod_{0 \leq j \leq m-p^{r_m}-1} (Y - b_{\sigma_j})$.*

Proof. Let $\psi(X, Y)$ be an arbitrary polynomial in the ideal I . It is easily seen that it can be reduced uniquely modulo the ideal (M, N, L) to a polynomial ψ_{red} , since the higher coefficients of L, M, N are equal to 1. By its reduction we mean a polynomial that is congruent to it modulo (M, N, L) and has a non-zero coefficient at $X^i Y^j$ only if $(b_{\sigma_{i+1}}, b_{\sigma_{j+1}}) \in A_{m-1}$.

Now we have to prove that a polynomial ψ_{red} that belongs to I and contains non-zero coefficients only at powers mentioned above has to be equal to 0. It is sufficient to prove this statement for polynomials over the field R_0 that is the fraction field of R since it does not depend on the ring. We note that if we take for all $g(X, Y) \in R_0(X, Y)$ their values $G(b_{\sigma_i}, b_{\sigma_j}), (b_{\sigma_i}, b_{\sigma_j})$ in A_{m-1} , then we obtain a vector subspace of values in $R_0^{(p^{r_m}+1)(m-1)+1}$. It is easily seen that any set of values corresponds to some polynomial in $R_0(X, Y)$. A similar statement is obvious for polynomials in one variable and is easily carried on by induction to the case of any number of variables. It follows that the dimension of the space of values is equal to $(p^{r_m} + 1)(m - 1) + 1$. The map $R_0[X, Y] \rightarrow C$, where C is the $(p^{r_m} + 1)(m - 1) + 1$ -dimensional space of values of polynomials in $R_0[X, Y]$ in points of A_{m-1} , factorizes through the space I' of reduction polynomials in $R_0[X, Y]$. So it follows from the equality of the dimensions that $\text{Ker}(I' \rightarrow C) = \{0\}$ and thus $\psi_{\text{red}} = 0$. Lemma is proved. \square

It is easily seen that we may also use this lemma for the ring of power series. Indeed, we can reduce series modulo $\prod_{i < n} (X - b_i) \prod_{i < n} (Y - b_i)$ and obtain polynomials.

Now we make the m -th step of formal group construction.

According to Lemma, the series from (44) can be represented in a form

$$\chi_{m-1}(X, Y) = fM + gN + hL, \quad (45)$$

where $f, g, h \in R[[X, Y]]$, and $R = \mathfrak{O}[[V_m, \dots, V_n]]$.

We consider the following relation:

$$\chi_{m-1}(b_{p^{r_m}}, b_{m-p^{r_m}}) = 0.$$

It follows from the definition of M and N that $fM(b_{p^{r_m}}, b_{m-p^{r_m}}) = gN(b_{p^{r_m}}, b_{m-p^{r_m}}) = 0$. We need h to be equal to 0. We consider $h(X, Y)$ in the point $(b_{p^{r_m}}, b_{m-p^{r_m}})$. It is clear that $h(b_{p^{r_m}}, b_{m-p^{r_m}}) \in R[b_{p^{r_m}}, b_{m-p^{r_m}}] \subset R$. Besides that

$$h(b_{p^{r_m}}, b_{m-p^{r_m}}) \equiv \text{absolute term of } (X, Y) \pmod{\tilde{\mathfrak{M}}_{\mathfrak{o}}[[V_m, \dots, V_n]]}.$$

Since in M, N, L only higher coefficients are invertible, in the relation (45) the coefficient at $X^{p^{r_m}} Y^{m-p^{r_m}}$ of the series $\chi_{m-1}(X, Y)$ is equal to

$$\text{the absolute term of } h(X, Y) + \text{an element of } \tilde{\mathfrak{M}}_{\mathfrak{o}}[[V_m, \dots, V_n]].$$

On the other hand it is equal to $V_m + \text{const}$, $\text{const} \in \mathfrak{o}$, as $\chi_{m-1}(X, Y) = F_V(X, Y) - f(X, Y)$. Thus we obtain

$$V_m + c = h(b_{p^{r_m}}, b_{m-p^{r_m}}) + d,$$

where $c \in \mathfrak{o}$, $d \in \tilde{\mathfrak{M}}_{\mathfrak{o}}[[V_m, \dots, V_n]]$. We chose V_m so that $h(b_{p^{r_m}}, b_{m-p^{r_m}}) = 0$ (in the formal group we replace V_m by a series in V_{m+1}, \dots, V_n). So we made the m -th step. Since all the formal group laws F_V^m are commutative and associative, we can apply to the group $H = F_V^m(\tilde{\mathfrak{M}}_{\mathfrak{o}}[[V_{m+1}, \dots, V_n]])$, $f: \sigma \rightarrow b_{\sigma}$ the first part of Lemma 4.5 and so indeed after the $m-1$ -th step the group F_V^{m-1} fits the relations (43) that are necessary for the m -th step. From the second part of Lemma 4.5 it follows that after the last (n -th) step all the relations for $b_{\sigma_i}, b_{\sigma_j}$ are fulfilled and all the variables V_i are got rid of and thus we obtained the desired formal group law $F = F_V^n$ in $\mathfrak{o}[[X, Y]]$.

Remark 4.6.2. The proof of Theorem 4.3.1 also implies that the formal group law F that fits the relations $b_{\sigma} \underset{F}{+} b_{\tau} = b_{\sigma\tau}$, $\sigma, \tau \in G$ and for which all the S_i , $i > n$ in expression $F(X, Y)$ through $F_S(X, Y)$, is unique. Besides that when we started instead of fixing $S_i = 0$, $i > n$ we could demand S_i , $i > n$ to be equal to arbitrary convergent series in S_2, \dots, S_n with integral coefficients and obtain a similar statement.

§5 THE PROOF OF NECESSITY IN THEOREM A

Now we show that our extension is indeed Kummer for the formal group we constructed.

We have a formal group $F(X, Y)$ such that

$$F(b_\sigma, b_\tau) = b_{\sigma\tau}. \tag{46}$$

We introduce again the addition with the means of the formal group F on the maximal ideal $\mathfrak{M}_\otimes = \mathfrak{D}_K \otimes \mathfrak{M} + \mathfrak{M} \otimes \mathfrak{D}_K$ of the tensor product $\mathfrak{D}_K \otimes \mathfrak{D}_K$. We denote the formal module obtained by $F(\mathfrak{M}_\otimes)$.

Now let $\xi = \sum a_\sigma \sigma$ act as in (4). Let α be equal to $\delta\phi^{-1}(\xi)$. Our aim in the remaining subsections is the proof of the following statement.

PROPOSITION 5.1. *There are elements x and y in \mathfrak{M} such that*

$$\alpha = x \otimes 1 +_F 1 \otimes y.$$

Here we show that the statement of Proposition implies theorem A.

Suppose that 5.1 is fulfilled. We can express y as $1 \otimes z$, $z \in \mathfrak{M}$ and so $\alpha = x \otimes 1 +_F 1 \otimes z$. Using the formula for ψ_1 and the fact that $b_1 = 0$ we obtain that $0 = b_1 = \psi_1(\alpha) = x +_F z$. Thus z is equal to $[-1]_F(x)$ ($[-1]_F(x)$ is the inverse to x in $F(\mathfrak{M})$) and it follows that $\alpha = x \otimes 1 -_F 1 \otimes x$. Similarly

$$b_\sigma = \psi_\sigma(\alpha) = \psi_\sigma(x \otimes 1) -_F \psi_\sigma(1 \otimes x) = x -_F \sigma(x).$$

We obtain that the conjugates of x in the extension K/k are exactly the elements of the form $x +_F b_\sigma$. Then $\prod (x +_F b_\sigma) \in \mathfrak{o}$ and $v_k(\prod (x +_F b_\sigma)) = 1$, thus the extension K/k is Kummer for the formal group F and is generated by a root of the equation $P(X) = w$ while $v_k(w) = 1$. Theorem A of the introduction is proved.

5.2. Now we start proving 5.1.

Let n be equal to $p^l = [K : k]$. Consider a tower of intermediate extensions:

$$k = k_0 \subset k_1 \subset k_2 \subset \dots \subset k_l = K, [k_i : k_{i-1}] = p.$$

We take representatives τ_i for the generators of the Galois groups $G_i = \text{Gal}(k_i/k_{i-1})$. For all $\tau \in G$ we prove the following equality:

$$\tau(\alpha) = \alpha -_F b_\tau \tag{47}$$

(we assume here that the group G acts only on the first component of the tensor product).

Indeed, for any $z \in K$ we have

$$\phi(\tau(x) \otimes y)(z) = \tau(x) \operatorname{tr} yz = \tau(x \operatorname{tr} yz) = \tau(\phi(x \otimes y)(z)),$$

and so for each $\beta \in K \otimes_k K$ the equality

$$\phi((\tau \otimes 1)\beta(z)) = \tau(\phi(\beta)(z)) \quad (48)$$

is also fulfilled. Thus we obtain

$$\tau(\delta\xi) = \sum_{\sigma} b_{\sigma} \tau \sigma = \sum_{\sigma} (b_{\tau\sigma} - b_{\tau}) \sigma_{\tau} = \sigma\xi - (b_{\tau} \operatorname{tr}).$$

The formula (48) now implies (47).

5.3. Let \mathfrak{o}_i be the ring of integers of the field k_i . For each $i : 0 \leq i \leq l$ we prove by induction the following lemma.

LEMMA 5.3. *There is an equality*

$$\alpha = x \otimes 1 + y, \quad y \in \mathfrak{o}_i \otimes \mathfrak{M} \quad (49)$$

Proof. For $i = l$ the claim is obvious.

Let the claim be fulfilled for $i = s + 1$.

We can expand the element y in the base of the formal module $F(\mathfrak{o}_{s+1} \otimes \mathfrak{M})$:

$$y = \sum_{0 \leq i, 0 \leq j < n} (F)a_{ij} \pi_{s+1}^i \otimes \pi^j, \quad (50)$$

where π_{s+1} is a prime element of the field k_{s+1} , the coefficients a_{ij} are either equal to 0, or $a_{ij} \in \mathfrak{o}^*$ (for $j \geq n$ we extract the prime element π_0 of the field k from π^n and convert it into the first component).

For the automorphism τ_{s+1} we have the equality (47):

$$\tau_{s+1}(\alpha) = \alpha - b_{\tau_{s+1}}. \quad (51)$$

Now we express α in the form

$$x \otimes 1 + \sum_{0 \leq i, 0 \leq j < n} (F)b_{ij} \pi_s^i \otimes \pi^j + \sum_{0 \leq i, 0 \leq j < n} (F)a_{ij} \pi_{s+1}^i \otimes \pi^j. \quad (52)$$

We consequently convert the third summand in (52) into the first and the second, increasing the minimum of $ni + j$ for i, j such that $a_{ij} \neq 0$. Out of all pairs (i, j) for which $a_{ij} \neq 0$ we chose a pair with the least i , which we denote by i_0 , further out of all pairs (i_0, j) such that $a_{i_0 j} \neq 0$ we chose the pair with the least j and denote it by j_0 . We call the corresponding ordering of (i, j) by order.

We have three cases.

Case I. If $j_0 = 0$, then

$$a_{i_0 j_0}(\pi_{s+1}^{i_0} \otimes \pi^{j_0}) = a_{i_0 0}(\pi_{s+1}^{i_0} \otimes 1) \tag{53}$$

and we import this term into the first summand in (52). It is clear that subtracting with respect to F the term $a_{i_0 0}(\pi_{s+1}^{i_0} \otimes 1)$ gives only the terms of greater order (since $X - Y = (X - Y)(1 + r(X, Y))$, $r(X, Y) \in (X, Y)\mathfrak{o}[[X, Y]]$) and so we increase the value of $ni_0 + j_0$.

Case II. Now let j_0 be not equal to 0. If $p \mid i_0$ then $\pi_{s+1}^{i_0} = \pi_s^{\frac{i_0}{p}} + r$, where $v_{s+1}(r) > i_0$ and $\frac{i_0}{p} \in \mathbb{Z}$ and thus

$$a_{i_0 j_0}(\pi_{s+1}^{i_0} \otimes \pi^{j_0}) = a_{i_0 j_0} \pi_s^{\frac{i_0}{p}} \otimes \pi^{j_0} + \text{terms of greater order.} \tag{54}$$

It follows that we can import the term $a_{i_0 j_0} \pi_s^{\frac{i_0}{p}} \otimes \pi^{j_0}$ into the second summand of the formula (52) and increase the minimum of $ni + j$ again.

Case III. It remains to consider the case $(i_0, p) = 1$, $j_0 \neq 0$. We consider

$$\begin{aligned} \tau_{s+1}(\alpha) - \alpha &= \tau_{s+1}(x \otimes 1) - (x \otimes 1) + (\tau_{s+1} - 1)a_{i_0 j_0}(\pi_{s+1}^{i_0} \otimes \pi^{j_0}) \\ &\quad + (\tau_{s+1} - 1)(\text{terms of greater order}). \end{aligned}$$

We have:

$$\begin{aligned} \tau_{s+1}(x \otimes 1) - (x \otimes 1) &= (\tau_{s+1}(x) - x) \otimes 1 \in \mathfrak{M} \otimes \mathfrak{o} \\ a_{\tau_{s+1}} &= a_{\tau_{s+1}} \otimes 1 \in \mathfrak{M} \otimes \mathfrak{o}. \end{aligned} \tag{55}$$

So the element $(\tau_{s+1} - 1)a_{i_0 j_0}(\pi_{s+1}^{i_0} \otimes \pi^{j_0}) + (\tau_{s+1} - 1)(\text{terms of greater order})$ also belongs to $\mathfrak{M} \otimes \mathfrak{o}$. Yet that is impossible since

$$\begin{aligned} (\tau_{s+1} - 1)a_{i_0 j_0}(\pi_{s+1}^{i_0} \otimes \pi^{j_0}) &\equiv a_{i_0 j_0}(\tau_{s+1}\pi_{s+1}^{i_0} - \pi_{s+1}^{i_0}) \otimes \pi^{j_0} \\ &\text{mod (terms of greater order).} \end{aligned}$$

The remaining terms indeed have greater $ni + j$ since $(i_0, p) = 1$ and so the valuation of $\tau_{s+1}\pi_{s+1}^{i_0} - \pi_{s+1}^{i_0}$ in k_{s+1} is equal to $i_0 + h_{s+1, s+1}$, where $h_{s+1, s+1}$ is the ramification jump of τ_{s+1} in the field K_{s+1} . Thus we obtain

$$a_{i_0 j_0}(\tau_{s+1}\pi_{s+1}^{i_0} - \pi_{s+1}^{i_0}) \otimes \pi^{j_0} + (\text{terms of greater order}),$$

and this sum cannot belong to $\mathfrak{M} \otimes \mathfrak{o}$ since j_0 does not contain n from our assumptions (it can be easily proved by considering the expansion of an element of $\mathfrak{M} \otimes \mathfrak{o}$ in the base $\mathfrak{D}_K \otimes \mathfrak{D}_K$ over \mathfrak{o} .) So this case is impossible. Thus our assertion is valid for $i = s$. Lemma 5.3 is proved. \square

Now by applying the lemma 5.3 for $i = 0$ we obtain $\alpha = x \otimes 1 + y$, $y \in \mathfrak{o} \otimes \mathfrak{M}$.

Theorem A is proved completely.

REFERENCES

- [Be] F. Bertrandias, *Sur les extensions cycliques de degré p^n d'un corps local*, Acta arithmetica **34** (1979), 361–377.
- [B-F] F. Bertrandias and M.-J. Ferton, *Sur l'anneau des entiers d'une extension cyclique de degré premier d'un corps local*, C. R. Acad. Sc. Paris **274** (1972), A1330–A1333.
- [BVZ] M. V. Bondarko, S. V. Vostokov, I. B. Zhukov, *Additive Galois module*, Algebra and Analysis **9** (1997), no. 4, 28–46.
- [BV] M. V. Bondarko, S. V. Vostokov, *Decomposability of ideals in Abelian p -extensions of plenal fields I to appear*.
- [By1] N. Byott, *Galois structure of ideals in wildly ramified Abelian p -extensions of a p -adic field and some applications*, Journal de Theorie des nombres de Bordeaux **9** (1997), 201–219.
- [By2] N. Byott, *On Galois isomorphisms between ideals in extensions of local fields*, Manuscripta Math. **73** (1991), 289–311.
- [By3] N. Byott, *Tame and Galois extensions with respect to Hopf orders*, Math. Z. **220** (1995), 495–522.
- [Ch] Shin-Ping Chan, *Relative Lubin-Tate formal groups and Galois module structure*, Manuscripta Math. **75** (1991), 109–113.
- [Chi] L. N. Childs, *Taming wild extensions with Hopf algebras*, Trans. Am. Math. Soc. **304** (1987), 111–140.
- [CM] L. N. Childs, D. J. Moss, *Hopf algebras and local Galois module theory*, Advances in Hopf algebras, Lect. Notes on pure and applied Math. **158** (1994), 1–14.
- [F1] M.-J. Ferton, *Sur les idéaux d'une extension cyclique de degré premier d'un corps local*, C. R. Acad. Sc. Paris **276** (1973), no. A, 1483–1486.
- [F2] M.-J. Ferton, *Sur l'anneau des entiers de certaines extensions cycliques d'un corps local* Soc. Mathem. de France., Asterisque **24-25** (1975), 21–27.
- [Fr] A. Fröhlich, *Galois module structure of algebraic integers*, Springer, Ergeb. Math. Grenzgeb, 1983.
- [G] G. Greither, *Extensions of finite group schemes and Hopf Galois theory over a complete discrete valuation ring*, Math. Z. **210** (1992), 37–67.
- [Ha] Michiel Hazewinkel, *Formal groups and applications*, 1978.
- [Im] Tsunchisa Imada, *Galois module structure of local rings of integers via relative Lubin-Tate groups*, Memoirs of the Faculty of Science, Kyushu University **47** (1993), no. A, 71–77.
- [L] Heinrich W. Leopoldt, *Über die Hauptordnung der ganzen Elemente eines abelschen Zahlkörpers*, J. Reine Angew. Math. **201** (1959), 119–149.
- [Le1] G. Lettl, *Relative Galois module structure of integers of local Abelian fields*, Acta Arithmetica **85** (1998), no. 3, 235–248.
- [Le2] G. Lettl, *Note on the Galois module structure of quadratic extensions*, Col. Math. **LXVII** (1994).

- [N] E. Noether, *Normalbasis bei Körpern ohne höhere Verzweigung*, J. Reine Angew. Math. **167** (1932), 147–152.
- [Se] Jean-Pierre Serre, *Local fields*, Graduate Texts in Mathematics, vol. 67, Springer-Verlag, Berlin –Heidelberg–New York, 1979.
- [T1] M. J. Taylor, *Formal groups and the Galois module structure of local rings of integers*, J. Reine Angew. Math. **358** (1985), 97–103.
- [T2] M. J. Taylor, *Hopf structure and the Kummer theory for formal groups*, J. Reine Angew. Math. **375/376** (1987), 1–11.

Prof. M. Bondarko
Department of
Mathematics and Mechanics
St. Petersburg State University
Bibliotechnaya pl. 2,
St. Petersburg, 198904, Russia
m@vbond.usr.pu.ru

CROSSOVER COLLISION OF SCROLL WAVE FILAMENTS

BERNOLD FIEDLER AND ROLF M. MANTEL

Received: December 20, 1999

Revised: December 19, 2000

Communicated by Alfred K. Louis

ABSTRACT. Scroll waves are three-dimensional stacks of rotating spiral waves, with spiral tips aligned along filament curves. Such spatio-temporal patterns arise, for example, in reaction diffusion systems of excitable media type.

We introduce and explore the crossover collision as the only generic possibility for scroll wave filaments to change their topological knot or linking structure. Our analysis is based on elementary singularity theory, Thom transversality, and backwards uniqueness property of reaction diffusion systems.

All phenomena are illustrated numerically by six mpeg movies downloadable at

<http://www.mathematik.uni-bielefeld.de/documenta/vol-05/21.html>
and, in the printed version, with six snapshots from each sequence.

1991 Mathematics Subject Classification: 35B05, 35B30, 35K40, 35K55, 35K57, 37C20

Keywords and Phrases: Parabolic systems, scroll wave patterns, scroll wave filaments, spirals, excitable media, crossover collision, singularity theory, Thom transversality, backwards uniqueness, video.

1 INTRODUCTION

Spatio-temporal scroll wave patterns have been observed both experimentally and in numerical simulations of excitable media in three space dimensions. See for example [36, 25, 20] and the references there. Typical experimental settings are the Belousov-Zhabotinsky reactions and its many variants.

In two space dimensions, or in suitable planar sections through scroll wave patterns, rigidly rotating spiral wave patterns occur; see figure 1. For pioneering analysis motivated by propagation of electrical impulses in the heart muscle

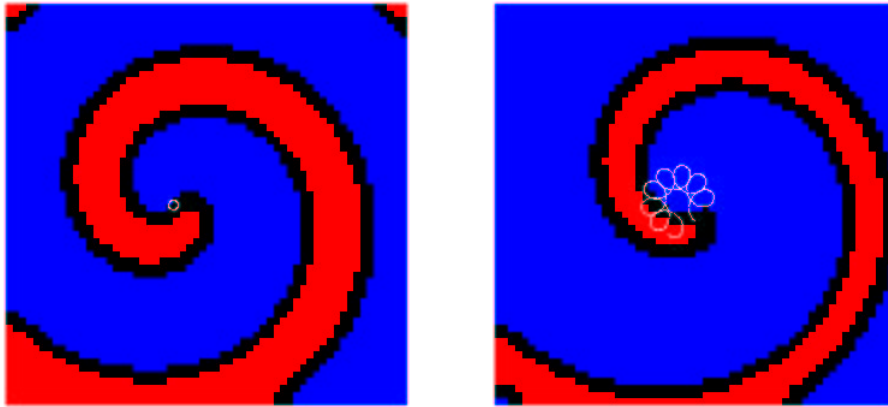

FIGURE 1: Spiral wave patterns (model see section 6). Shown on the left is a rigidly rotating spiral wave with parameters as in section 6, on the right is a meandering spiral wave, with parameter $a = 0.65$ instead of $a = 0.8$. For color coding see section 7.

see [34], 1946. Meandering tip motions are also observed; see for example [35, 38, 5, 4] and the references there. There is some ambiguity in the definition of the tip of a spiral. It is an admissible definition in the sense of [13, sec.4], to associate tip positions $(x_1, x_2) \in \mathbb{R}^2$ at time $t \geq 0$ with the location of zeros of two components (u^1, u^2) of the solution describing the state of the system:

$$(1.1) \quad u = (u^1, u^2)(t, x_1, x_2) = 0.$$

In a typical excitable medium the values of (u^1, u^2) trace out a cycle as shown in figure 2, along x -circles around the spiral tip. In a singular perturbation setting, steep wave fronts are observed along these x -circles. Only near the spiral tip, these u -cycles shrink rapidly to the tip-value $u = 0$.

This scenario, among other observations, motivated Winfree to attempt a phenomenological description in terms of states $\varphi = u/|u| \in \mathbb{S}^1$, for (almost) all $x \in \mathbb{R}^2$, with remaining singularities of φ at the tip positions. In the present paper, we return to a reaction diffusion setting for $u = u(t, x) \in \mathbb{R}^2$, keeping in mind that the set $u(t, x) = 0$ is particularly visible, distinguished, and descriptively important – not as an “organizing center” which causes the global dynamics to follow its pace, but rather as a highly visible indicator of the global dynamics. In fact, defining tip positions by other nonzero levels $(t, x) \equiv \text{const.}$, inside the cycle of figure 2, works just as well, and only reflects some of the ambiguity in the notion of “tip position”, as was mentioned above. With all our results below holding true, independently of such a shift of u -values, we proceed to work with $u(t, x) = 0$ as a definition of tip position.

Scroll waves in three space dimensions $x = (x_1, x_2, x_3) \in \mathbb{R}^3$ can be viewed

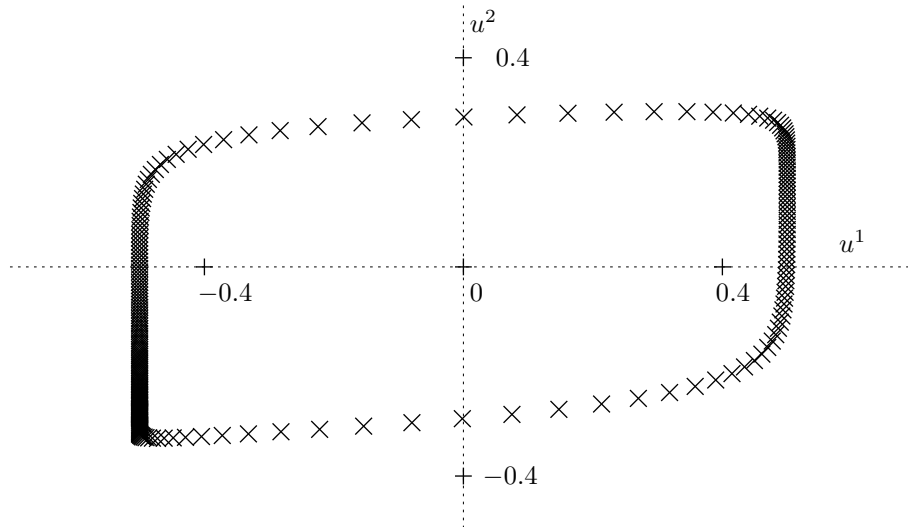

FIGURE 2: A cycle of values $(u^1, u^2)(t, x_0)$ through a time-periodic wave front at a suitably fixed position x_0 in an excitable medium (see section 6). Polar coordinates define a phase $\varphi \in \mathbb{S}_1$ along the dotted cycle.

as stacks of spiral waves with their tips aligned along a one-dimensional curve called the tip *filament*. As in the planar case, the tip filament may move around in \mathbb{R}^3 , and the associated sectional spirals may continuously change their shapes and their mutual phase relations with time. Denoting by (u^1, u^2) two components of the solutions of the associated reaction diffusion systems, again, we can consider filaments φ^t as given by the zero sets

$$(1.2) \quad u = (u^1, u^2)(t, x_1, x_2, x_3) = 0.$$

We use two components here because the local dynamics of excitable media are essentially two-dimensional. More precisely, for each fixed time $t > 0$ the filaments φ^t describe the zeros $x \in \mathbb{R}^3$ of the solution profile

$$(1.3) \quad x \mapsto u(t, x).$$

In other words, the filament φ^t is the zero level set of the solution profile $u(t, \cdot)$ at time t .

Suppose zero is a regular value of $u(t, \cdot)$, that is, the x -Jacobian $u_x(t, \cdot)$ possesses maximal rank 2 at any zero of u . Then the filaments φ^t consist of embedded curves in \mathbb{R}^3 , by the implicit function theorem. Moreover the filaments depend as smoothly on t as smoothness of the solution u permits.

Therefore, *collision* of filaments can occur only if the rank of $u_x(t, \cdot)$ drops. To

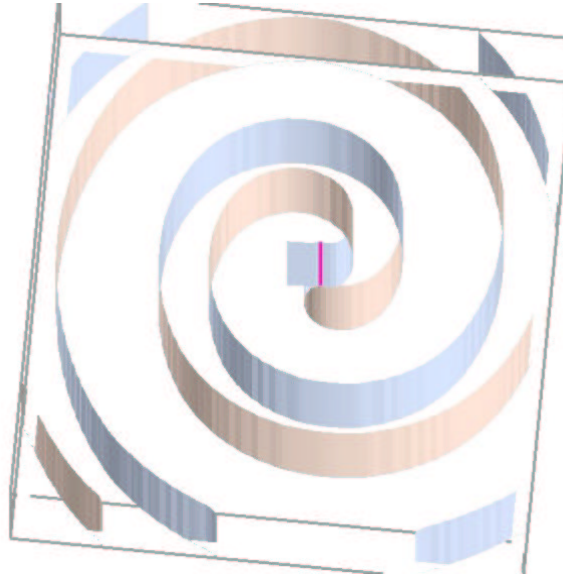

FIGURE 3: A scroll wave and its filament. The band is tangential to the wave front at the filament.

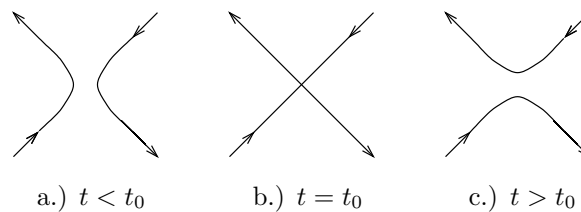

FIGURE 4: Crossover collision of oriented filaments at time $t = t_0$

analyze the simplest possible case, we assume

$$(1.4) \quad \begin{array}{l} u(t_0, x_0) = 0, \\ \text{co-rank } u_x(t_0, x_0) = 1. \end{array}$$

Let P denote a rank one projection along range $u_x(t_0, x_0)$ onto any complement of that range. Let $E = \ker u_x(t_0, x_0)$ denote the two-dimensional null space of the 2×3 Jacobean matrix u_x . We assume the following non-degeneracy conditions for the time-derivative u_t and the Hessian u_{xx} , restricted to E :

$$(1.5) \quad \begin{array}{l} Pu_t(t_0, x_0) \neq 0, \text{ and} \\ Pu_{xx}(t_0, x_0)|_E \text{ is strictly indefinite.} \end{array}$$

A specific example $u(t, x)$ satisfying assumptions (1.4), (1.5) at $t = t_0$, $x_0 = 0$

is given by

$$(1.6) \quad \begin{aligned} u^1(t, x) &= (t - t_0) + x_1^2 - x_2^2 \\ u^2(t, x) &= x_3. \end{aligned}$$

In figure 4 we observe the associated *crossover collision* of filaments in projection onto the null space E : at $t = t_0$ two filaments collide, and then reconnect. Note that after collision the two filaments do not reconnect as before, re-establishing the previous filaments. Instead, they *cross over*, forming bridges between originally distinct filaments. Figure 4 describes the universal unfolding, by the time “parameter” t , of a standard transcritical bifurcation in x -space. In fact, suppose $u(t, x)$ satisfies assumptions (1.4), (1.5). Then there exists a local diffeomorphism

$$(1.7) \quad \begin{aligned} \tau &= \tau(t) \\ \xi &= \xi(t, x) \end{aligned}$$

mapping (t_0, x_0) to $\tau_0 = t_0$, $\xi_0 = 0$, such that the original zero set transforms to that of example (1.6), rewritten in (τ, ξ) -coordinates. This follows from Lyapunov-Schmidt reduction and elementary singularity theory; see for example [15].

In an early survey, Tyson and Strogatz [31] hinted at topologically consistent changes of the connectivity of oriented tip filaments, as a theoretical possibility. The point of the present paper is to identify specific singularities, in the sense of singularity theory, which achieve such changes and which, in addition, are generic with respect to the initial conditions of general reaction diffusion systems. Genericity refers to topologically large sets. These sets contain countable intersections of open dense sets, and are dense. We caution our PDE readers here that we are *not* addressing issues like loss of regularity (smoothness) or development of singularities in a blow-up sense. Genericity is based on perturbations of only the initial conditions. We do not require any perturbations of the underlying partial differential equations themselves.

We consider it a fundamental idea to study solutions $u(t, x)$ of partial differential equations, qualitatively, by investigating the singularities of their level sets – possibly for all, or at least for generic initial conditions. Such an idea is already present in work by Schaeffer, [27], and more recently by Damon, [7], [8], [9] and the references there. In view of example (2.12) for linear scalar parabolic equations in one space dimension below, the first relevant example can even be attributed to Sturm [28], 1836. For present day relevance of Sturm’s observations, once motivated by Sturm-Liouville theory, see also [3], [12], [23]. The work by Schaeffer addresses level sets of strictly convex scalar hyperbolic conservation laws in one space dimension. His analysis is based on the variational formulation due to Lax: for almost every (t, x) the solution $u(t, x)$ appears as the pointwise minimizer of a given function, which involves the initial conditions $u_0(x)$ explicitly. The backwards uniqueness problem, a somewhat delicate technical point for our parabolic systems, is circumvented by the explicit Lax formula in his context.

Damon's work is motivated by Gaussian blurring and by applications of the linear heat equation to image processing, but applies to a large class of differential operators. Unfortunately, the partial differential equations are viewed as purely local constraints on the k -jet of "solutions". Neither initial nor boundary conditions are imposed on these "solutions". Genericity is understood purely in the space of smooth such "solutions". The important nonlocal PDE issue of genericity in terms of initial conditions, as addressed in our present paper, has not been resolved by Damon's approach.

In contrast to these abstract results, strongly in the spirit of pure singularity theory, our motivation is the global qualitative dynamics of reaction diffusion systems. In particular, we do require our solutions $u = u(t, x)$ to not only satisfy the underlying partial differential equations near (t_0, x_0) but also the respective initial and boundary conditions. For a technically detailed statement see our main result, theorem 2.1 below. As a consequence, the crossover of filaments just described is the one and only non-destructive collision of filaments possible – for a generic set of initial conditions. See theorem 2.2.

The remaining sections are organized as follows. Preparing for the proof of theorem 2.1, we provide an abstract jet perturbation lemma in section 3 which is based on backwards uniqueness results for linear, non-autonomous parabolic systems. In section 4, we prove theorem 2.1 using Thom's jet transversality theorem. Moreover we present a generalization to the vector case $u \in \mathbb{R}^m$, $m \geq 2$, in corollary 4.2. Theorem 2.2 is proved in section 5. Section 6 summarizes a fast numerical method, due to [11, 22], for time integration of a specific excitable medium with steep fronts in three space dimensions. In section 7 we adapt this method to compute filaments and their associated local isochrone phase bands. We conclude with numerical examples illustrating crossover collisions in autonomous and periodically forced reaction diffusion systems, including the unlinking of linked twisted scroll rings and the unknotting of a trefoil torus knot filament; see section 8.

ACKNOWLEDGMENT. Both authors are grateful to the Institute of Mathematics and its Applications (IMA), Minneapolis, Minnesota. The main part of this work was completed there during a PostDoc stay of the second author and several visits of the first author as senior visiting scientist during the special year "Emerging Applications of Dynamical Systems", 1997/98. We are indebted to Jim Damon for helpful discussions, and to the referee for additional references. We thank Martin Rumpf and Peter Serocka for help with visualization. Support by the Deutsche Forschungsgemeinschaft is also gratefully acknowledged.

2 MAIN RESULTS

For a technical setting we consider semilinear parabolic systems

$$(2.1) \quad u_t^i = \operatorname{div}_x(d^i(t, x)\nabla_x u^i) + f^i(t, x, u, \nabla_x u)$$

throughout the present paper. Here $u = (u^1, \dots, u^m) \in \mathbb{R}^m$, $x = (x_1, \dots, x_N) \in \Omega \subset \mathbb{R}^N$. The data d^i, f^i are smooth with uniformly posi-

tive definite diffusion matrices d^i . The bounded open domain Ω is assumed to have smooth boundary. Inhomogeneous mixed linear boundary conditions

$$(2.2) \quad \alpha_i(x)u^i(t, x) + \beta_i(x)\partial_\nu u^i(t, x) = \gamma(x)$$

with smooth data and $\alpha_i, \beta_i \geq 0$, $\alpha_i^2 + \beta_i^2 \equiv 1$ are imposed. Periodic boundary conditions are also admissible, as well as uniformly parabolic semilinear equations on compact manifolds with smooth boundaries, if any.

The solutions

$$(2.3) \quad u = u(t, x; u_0)$$

of (2.1), (2.2) with initial condition

$$(2.4) \quad u(0, x; u_0) := u_0(x)$$

define a local semi-evolution system in the phase space X of profiles $u_0(\cdot)$ in any of the Sobolev spaces $W^{k',p}(\Omega)$, $k' > N/p$, which satisfy the boundary conditions (2.2); see [16] for a reference. By the smoothing property of the parabolic system, solutions are in fact smooth in their maximal open intervals of existence $t \in (0, t_+(u_0))$ and depend smoothly on $u_0 \in X$, both when viewed pointwise and when viewed as x -profiles $u(t, \cdot; u_0) \in X$.

To address the issue of singularities $u(t_0, x_0) = 0$, in the sense of singularity theory, we consider the *jet space* J_x^k of Taylor-polynomials in $x = (x_1, \dots, x_N) \in \mathbb{R}^N$ of degree at most k , with real coefficients and vector values $u \in \mathbb{R}^m$. Defining the k -jet $j_x^k u$ with respect to x at (t_0, x_0) as

$$(2.5) \quad (j_x^k u)(t_0, x_0) := (u, \partial_x u, \dots, \partial_x^k u)(t_0, x_0),$$

Taylor expansion at x_0 allows us to interpret $j_x^k u(t_0, x_0)$ as an element of our linear jet space J_x^k satisfying

$$(2.6) \quad u(t_0, x_0) = 0.$$

Here and below, we assume that $k' > k + N/p$ so that the evaluation

$$(2.7) \quad u \mapsto j_x^k u(t_0, x_0)$$

becomes a bounded linear map from X to J_x^k , by Sobolev embedding.

On the level of k -jets, a notion of equivalence is induced by the action of local C^k -diffeomorphisms $x \mapsto \Phi(x)$, $u \mapsto \Psi(u)$ fixing the origins of $x \in \mathbb{R}^N$, $u \in \mathbb{R}^m$, respectively. Indeed, for any polynomial $\mathbf{p}(x) \in J_x^k$ with $\mathbf{p}(0) = 0$, we may consider the transformed polynomial

$$(2.8) \quad j_x^k(\Psi \circ \mathbf{p} \circ \Phi) \in J_x^k.$$

We call the jet (2.8) *contact equivalent* to $j_x^k \mathbf{p} = \mathbf{p}$; see for example [15].

By a *variety* $S \subset \mathbb{R}^\ell$ we here mean a finite disjoint union

$$(2.9) \quad S = \bigcup_{j=0}^{j_0} S_j$$

of embedded submanifolds $S_j \subset \mathbb{R}^\ell$ with strictly decreasing dimensions such that $S_{j_1} \cup \dots \cup S_{j_0}$ is closed for any j_1 . We call $\text{codim}_{\mathbb{R}^\ell} S_0$ the codimension of the variety S in \mathbb{R}^ℓ .

Similarly, by a *singularity* (in the sense of singularity theory) we mean a variety $S \subset J_x^k$ in the sense of (2.9), which satisfies $u = 0$ and is invariant under any of the contact equivalences (2.8). Let $\text{codim}_{J_x^k} S$ denote the codimension of S , viewed as a subvariety of J_x^k . Shifting codimension by $N = \dim x$ for convenience we call

$$(2.10) \quad \text{codim } S := (\text{codim}_{J_x^k} S) - N$$

the *codimension of the singularity* S . For example, a typical map $(t_0, x_0) \mapsto j_x^k u(t_0, x_0)$ with $x_0 \in \mathbb{R}^N, u \in \mathbb{R}^m$ will miss singularities of codimension 2 or higher. In contrast, the map can be expected to hit singularities S of codimension 1 at isolated points $t = t_0$, and for some $x_0 \in \mathbb{R}^N$. Having shifted codimension by N in (2.10) therefore conveniently allows us to observe that typical profiles of *functions* $u(t, \cdot)$ miss singularities of codimension 2 entirely, and encounter such singularities of codimension 1, anywhere in $x \in \mathbb{R}^N$, only at discrete times t . We aim to show that this simple arithmetic also works for *PDE solutions* $u(t, x)$ under generic initial conditions.

Since the geometrically simple issue of codimension is overloaded with – sometimes conflicting – definitions in singularity theory, we add some examples which illustrate our terminology. First consider the simplest case

$$(2.11) \quad S = \{u = 0\} \subset J_x^k.$$

where $u(t, \cdot) : \mathbb{R}^N \rightarrow \mathbb{R}^m$. Then $\text{codim } S = m - N$. For systems of $m = 2$ equations in $N = 0$ space dimensions, that is, for ordinary differential equations in the plane, typical trajectories fail to pass through the origin in finite time: $\text{codim } S = 2$. For $N = 1$, we can expect the solution curve profile $u(t, \cdot)$ to pass through the origin at certain discrete times t_0 and positions x_0 , because $\text{codim } S = 1$. For $N = 2$ we have $\text{codim } S = 0$. We therefore expect isolated zeros to move continuously with time: see our intuitive description of planar spiral waves in section 1 and figure 1. Since $\text{codim } S = -1$ for $N = 3$, we expect zeros of $u(t_0, \cdot)$ to occur along one-dimensional filaments, even for fixed t_0 . This is the case of scroll wave filaments φ^{t_0} in excitable media.

Next we consider a scalar one-dimensional equation, $m = N = 1$. Multiple zeros are characterized by

$$(2.12) \quad S = \{u = 0, u_x = 0\},$$

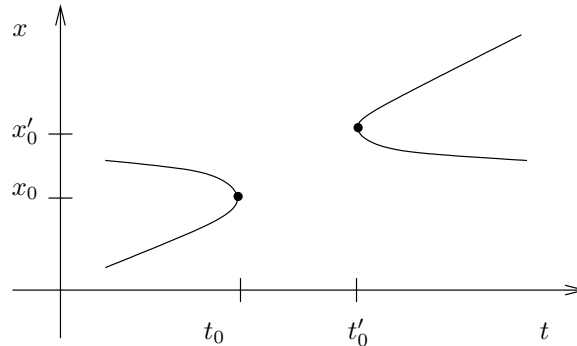

FIGURE 5: Saddle-node singularities of codimension 1.

a set to which we ascribe codimension 1. Indeed, we can typically expect a pair of zeros to coalesce and disappear as in (t_0, x_0) of figure 5. The opposite case, a pair creation of zeros as in (t'_0, x'_0) , does not occur for scalar nonlinearities f satisfying $f(t, x, 0, 0) = 0$. This observation, going back essentially to Sturm [28], conveys considerable global consequences for the associated semiflows; see for example [12] and the references there.

Passing to planar 2-systems, $m = N = 2$, the same saddle-node bifurcations of figure 5 could for example correspond to annihilation and creation of a pair of tips of counter-rotating spirals, respectively.

We conclude our series of motivating examples with the singularity (1.4) of filament collision in systems satisfying $N = m + 1$:

$$(2.13) \quad S = \{u = 0, \text{co-rank } u_x \geq 1\}.$$

Note that $\text{codim } S = 1$. For the stratum S_0 of S with lowest codimension we can assume that the quadratic form $Pu_{xx}|_E$ is indeed nondegenerate, in the notation of (1.5). Under the additional transversality assumption $Pu_t \neq 0$, the strictly indefinite case was discussed in section 1. It leads to crossover collisions, which are our main applied motivation here. The strictly definite case, positive or negative, leads to creation/annihilation of small circular filaments. For a numerical realization of the associated scroll ring annihilation we refer to the simulation in figure 8.

After our intermezzo on singularities we now address genericity. We say that a property of solutions $u(t, x; u_0)$ of our semilinear parabolic system (2.1) – (2.4) holds for *generic initial conditions* $u_0 \in X$ if it holds for a generic subset of initial conditions. Here subsets are *generic* (or *residual*) if they contain a countable intersection of open dense subsets of X . Recall that generic subsets and countable intersections of generic subsets are dense in complete metric spaces X , by Baire's theorem; see [10, ch. 12].

With these preparations we can now state our main result concerning solutions $u(t, x)$ of our parabolic system (2.1) – (2.4) with generic initial conditions $u_0 \in$

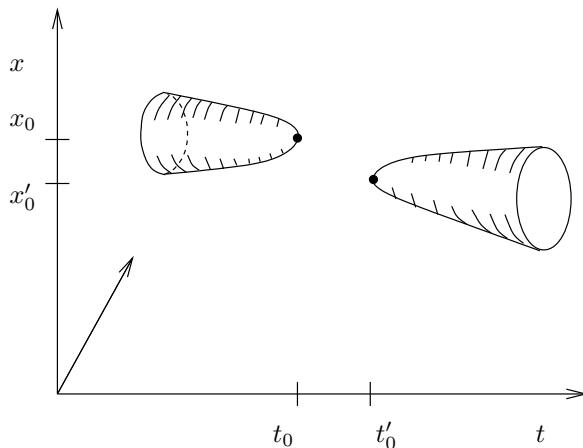

FIGURE 6: Annihilation (left) and creation (right) of closed filaments

$X \subset W^{k',p} \hookrightarrow C^k$. As before $0 \leq t < t_+(u_0)$ denotes the maximal interval of existence. Finally, we recall that a map $\rho : V \rightarrow J$ between Banach spaces is *transverse* to a variety $S = S_0 \cup \dots \cup S_{j_0}$, in symbols:

$$(2.14) \quad \rho \bar{\cap} S,$$

if $\rho(v) \in S_j$ implies

$$(2.15) \quad T_{\rho(v)}S_j + \text{range } D\rho(v) = J;$$

see for example [1, 19].

THEOREM 2.1 *For some fixed $k \geq 1$, consider a finite collection of singularities $S^i \subset J_x^k$, each of codimension at least 1. Then the following holds true for solutions $u(t, x)$ of (2.1) – (2.4) with generic initial conditions $u_0 \in X$. Singularities S^i with*

$$(2.16) \quad \text{codim } S^i \geq 2$$

are not encountered at any $(t_0, x_0) \in (0, t_+(u_0)) \times \Omega$. In other words, $j_x^k u(t_0, x_0) \in S^i$ for some $0 < t_0 < t_+(u_0)$, $x_0 \in \Omega$ implies $\text{codim } S^i = 1$. The map

$$(2.17) \quad \begin{array}{ccc} (0, t_+(u_0)) \times \Omega & \rightarrow & J_x^k \\ (t_0, x_0) & \mapsto & j_x^k u(t_0, x_0) \end{array}$$

is in fact transverse to each of the varieties S^i . In particular, the points (t_0^n, x_0^n) where the solution $u(t, x)$ encounters singularities S^i of codimension 1 are isolated in the domain $[0, t_+(u_0)) \times \Omega$ of existence. Although there can be countably many singular points (t_0^n, x_0^n) accumulating to the boundary $t_+(u_0)$ or $\partial\Omega$, the values t_0^n are pairwise distinct.

THEOREM 2.2 *For some fixed $k \geq 1$, consider solutions $u(t, x)$ of (2.1) – (2.4) with $N = 3$, $m = 2$, that is with $x \in \Omega \subset \mathbb{R}^3$ and $u(t, x) \in \mathbb{R}^2$. Then for generic initial conditions $u_0 \in X$ the following holds true.*

Except for at most countably many times $t = t_0^n \in (0, t_+(u_0))$, the filaments

$$(2.18) \quad \{x \in \Omega \mid u(t, x) = 0\}$$

are curves embedded in Ω , possibly accumulating at the boundary. At each exceptional value $t = t_0^n$, exactly one of the following occurs at a unique location $x_0^n \in \Omega$:

- (i) a creation of a closed filament, or*
- (ii) an annihilation of a closed filament, or*
- (iii) a crossover collision of filaments.*

For cases (i),(ii) see figures 6, 8; for case (iii) see figures 4, 9–13, and (1.4) – (1.6).

3 JET PERTURBATION

In this section we prove a perturbation result, lemma 3.1, which is crucial to our proof of theorem 2.1. We work in the technical setting of semilinear parabolic systems (2.1) – (2.4) with associated evolution

$$(3.1) \quad u = u(t, x; u_0)$$

on the phase space X of $W^{k',p}(\Omega)$ -profiles $u(t, \cdot, \cdot; u_0)$ satisfying Robin boundary conditions (2.2). Let $k' - \frac{N}{p} > k \geq 1$, to ensure the Sobolev embedding $X \hookrightarrow C^k(\Omega)$. Let

$$(3.2) \quad \mathcal{D} := \{(t, x, u_0) \mid x \in \Omega, u_0 \in X, 0 < t < t_+(u_0)\}$$

denote the interior of the domain of definition.

LEMMA 3.1 *The map*

$$(3.3) \quad \begin{aligned} j_x^k u: \mathcal{D} &\rightarrow J_x^k \\ (t, x, u_0) &\mapsto j_x^k u(t, x; u_0) \end{aligned}$$

is a C^κ map, for any κ . For any $(t, x, u_0) \in \mathcal{D}$, the derivative

$$(3.4) \quad D_{u_0} j_x^k u(t, x; u_0): X \rightarrow J_x^k$$

is surjective.

PROOF:

The regularity claim follows from smoothness of the data $d^i, f^i, \alpha_i, \beta_i$ and the smoothing action of parabolic systems; see for example [16, 26, 29, 14, 21].

To prove surjectivity of the linearization (3.4) with respect to the initial condition, we essentially follow [16]. First observe that for any fixed $x_0 \in \Omega$ the linear evaluation map

$$(3.5) \quad \begin{aligned} j_x^k: X &\rightarrow J_x^k \\ v &\mapsto j_x^k v(x_0) \end{aligned}$$

is bounded, because $X \hookrightarrow C^k(\Omega)$, and trivially surjective. Moreover, the jet space J_x^k is finite-dimensional. It is therefore sufficient to show that the linearization

$$(3.6) \quad \begin{aligned} D_{u_0} u(t, \cdot; u_0): X &\rightarrow X \\ v_0 &\mapsto v(t) \end{aligned}$$

possesses dense range, for all $u_0 \in X$, $0 < t_0 < t_+(u_0)$. Here $v(t, \cdot)$ satisfies the linearized parabolic system

$$(3.7) \quad v_t^i = \operatorname{div}_x(d_i(t, x)\nabla_x v^i) + f_p^i \cdot \nabla_x v + f_u^i \cdot v$$

with boundary conditions (2.2) for v and initial condition $v(0, \cdot) = v_0$. The partial derivatives f_p^i, f_u^i of the nonlinearity $f = f(t, x, u, p)$ are to be evaluated along $(t, x, u(t, x), \nabla_x u(t, x))$.

To show the density of range $D_{u_0} u(t, \cdot; u_0)$ in X , we now proceed indirectly. Suppose

$$(3.8) \quad \operatorname{clos}_X D_{u_0} u(t_0, \cdot; u_0)X \neq X.$$

Then X contains a nonzero element $w(t_0, \cdot)$ in the L^2 -orthogonal complement of $D_{u_0} u(t, \cdot; u_0)X$ in X . Consider the associated solution $w(t, \cdot) \in X$ of the formal adjoint equation

$$(3.9) \quad w_t^i = -\operatorname{div}_x(d_i(t, x)^T \nabla_x w^i) + \sum_j \operatorname{div}_x(w^j f_{p_i}^j) - (f_u^T w)_i$$

for $0 \leq t \leq t_0$, still with boundary conditions (2.2) but with “initial” condition $w(t_0, \cdot)$ at $t = t_0$. We again use the notation $f_{p_i}^j$ for the partial derivative of f^j with respect to ∇u^i , here.

Direct calculation shows that scalar products $\langle \cdot, \cdot \rangle$ between solutions $v(t, \cdot)$ of the linearization (3.7) and solutions $w(t, \cdot)$ of its formal adjoint (3.9) in $L^2(\Omega)$ are time-independent. Therefore, by construction of $w(t_0, \cdot)$

$$(3.10) \quad \langle v(t, \cdot), w(t, \cdot) \rangle_{L^2(\Omega)} = \langle v(t_0, \cdot), w(t_0, \cdot) \rangle = 0,$$

for all $0 \leq t \leq t_0$. Evaluating at $t = 0$, $v(0, \cdot) = v_0 \in X$, we conclude

$$(3.11) \quad \langle v_0, w(0, \cdot) \rangle_{L^2(\Omega)} = 0$$

for all $v_0 \in X$, and hence

$$(3.12) \quad w(0, \cdot) = 0.$$

In other words, the backwards parabolic system (3.9) possesses a solution $w(t, \cdot)$ which starts nonzero at $t = t_0 > 0$ but ends up zero at $t = 0$. This is a contradiction to the so-called backwards uniqueness property of parabolic equations. See for example [14], [16] and the references there. By contradiction, we have therefore proved that

$$(3.13) \quad \text{clos}_X D_{u_0} u(t_0, \cdot; u_0)X = X,$$

contrary to our indirect assumption (3.8). This completes the indirect proof of the perturbation lemma. \times

4 PROOF OF THEOREM 2.1

Our proof of theorem 2.1 is based on Thom’s transversality theorem [30, 1]. For convenience we first recall a modest adaptation of the transversality theorem, fixing notation. We use the concept of transversality of a map ρ to a variety S as explained in (2.9), (2.14), (2.15). The proof is based on Sard’s theorem and is not reproduced here.

THEOREM 4.1 [THOM TRANSVERSALITY]
 Let X be a Banach space, $\mathcal{D} \subseteq \mathbb{R}^\ell \times X$ open and

$$(4.1) \quad \begin{aligned} \rho : \mathcal{D} &\rightarrow \mathbb{R}^{\ell'} \\ (y, u_0) &\mapsto \rho(y, u_0) \end{aligned}$$

a C^κ -map. Let $S \subset \mathbb{R}^{\ell'}$ be a variety and assume

$$(4.2) \quad \rho \bar{\cap} S,$$

$$(4.3) \quad \kappa > \max\{0, \ell - \text{codim}_{\mathbb{R}^{\ell'}} S\}.$$

Then the set

$$(4.4) \quad X_S := \{u_0 \in X \mid \rho(\cdot, u_0) S, \text{ where defined}\}$$

is generic in X (that is: contains a countable intersection of open dense sets).

The point of the theorem is, of course, that in X_S transversality to S is achieved, for fixed u_0 , by varying only y in $\rho(y, u_0)$. For example, $u_0 \in X_S$ and $\text{codim}_{\mathbb{R}^{\ell'}} S > \ell$ imply

$$(4.5) \quad \rho(y, u_0) \notin S$$

whenever y is such that $(y, u_0) \in \mathcal{D}$. This follows immediately from condition (2.15) on transversality. In other words, for generic u_0 the image of $\rho(\cdot, u_0)$ misses varieties of sufficiently high codimension.

We now use theorem 4.1 to prove our main result, theorem 2.1. We consider the jet evaluation map

$$(4.6) \quad \rho(t, x, u_0) := j_x^k u(t, x; u_0)$$

of the evolution $u(t, \cdot; u_0)$ associated to our parabolic system; see (2.1) – (2.5). We choose \mathcal{D} to be the (open) domain of definition

$$(4.7) \quad \mathcal{D} = \{(t, x, u_0) \mid 0 < t < t_+(u_0), x \in \Omega, u_0 \in X\}$$

of the evolution; clearly $y = (t, x) \in \mathbb{R}^{N+1}$ so that $\ell = N + 1$. For the variety S we choose, successively, any of the finitely many singularities $S^i \subset J_x^k$ of theorem (2.1). Their codimensions as subvarieties of $J_x^k \cong \mathbb{R}^{\ell'}$ are

$$(4.8) \quad \text{codim}_{J_x^k} S^i = N + \text{codim } S^i;$$

see (2.10). Note that assumptions (4.2) and (4.3) both hold, independently of the choice of k for the varieties $S^i \subseteq J_x^k$, by lemma 3.1. Claim (2.17) about transversality of $(t_0, x_0) \mapsto u(t_0, x_0; u_0)$ to any singularity S^i is now just the statement of theorem 4.1.

Next, we prove that singularities S^i with $\text{codim } S^i \geq 2$ are missed altogether, for generic initial conditions $u_0 \in X$, as was claimed in (2.16). We evaluate (4.8) to yield

$$(4.9) \quad \text{codim}_{J_x^k} S^i = N + \text{codim } S^i \geq N + 2 > N + 1 = \ell$$

In view of example (4.5), this proves our claim (2.16): generically, only singularities S^i with $\text{codim } S^i = 1$ are encountered.

Now we prove that the positions (t_0^n, x_0^n) , where singularities S^i with $\text{codim } S^i = 1$ are encountered, are generically isolated in $[0, t_+(u_0)) \times \Omega$. Indeed assuming $j_x^k u_0 \notin S^i$, we have $t_0^n > 0$ without loss of generality. Since the lower-dimensional strata S_j^i , $j \geq 1$ of the singularity S^i are of (singularity) codimension ≥ 2 , they are missed by solutions entirely, for generic initial conditions u_0 . Therefore

$$(4.10) \quad j_x^k u(t_0^n, x_0^n; u_0) \in S_0^i$$

only hit the maximal strata, staying away from the closed union of lower-dimensional strata, uniformly in compact subsets of $[0, t_+(u_0)) \times \Omega$. Because the S_0^i are finitely many embedded submanifolds of codimension $N+1$ in J_x^k and because the crossings (4.10) are transverse, the corresponding crossing points (t_0^n, x_0^n) are also isolated in $[0, t_+(u_0)) \times \Omega$, as claimed.

It remains to show that the values t_0^n are mutually distinct for generic initial conditions $u_0 \in X$. To this end we consider the augmented map

$$(4.11) \quad \begin{aligned} \tilde{\rho} : \tilde{\mathcal{D}} &\rightarrow J_x^k \times J_x^k \\ (t, x_1, x_2, u_0) &\rightarrow (j_x^k u(t, x_1; u_0), j_x^k u(t, x_2; u_0)) \end{aligned}$$

on the open domain

$$(4.12) \quad \tilde{\mathcal{D}} := \{(t, x_1, x_2, u_0) \mid 0 < t < t_+(u), x_1, x_2 \in \Omega, x_1 \neq x_2, u_0 \in X\}.$$

To apply Thom’s transversality theorem 4.1, we only need to check the transversality assumption (4.2). In fact we show

$$(4.13) \quad \tilde{\rho} \bar{\cap} \{0\} \in J_x^k \times J_x^k.$$

This follows, analogously to lemma 3.1, from $x_1 \neq x_2$ and the fact that the linearization $D_{u_0}u(t_0, \cdot; u_0)$ possesses dense range in X ; see (3.6) – (3.13). We can therefore apply theorem 4.1 to $\tilde{\rho}$ with respect to the varieties

$$(4.14) \quad \tilde{S} := S^{i_1} \times S^{i_2}.$$

In $J_x^k \times J_x^k$, these varieties have codimension

$$(4.15) \quad \text{codim}_{J_x^k \times J_x^k} \tilde{S} = 2N + \text{codim } S^{i_1} + \text{codim } S^{i_2} = 2N + 2$$

Since this number exceeds

$$(4.16) \quad \dim(t, x_1, x_2) = 2N + 1,$$

the variety \tilde{S} is missed by $\tilde{\rho}(\cdot, \cdot, \cdot; u_0)$, for generic $u_0 \in X$. See example (4.5) again. Therefore the times t_0^n where singularities S^i can occur are pairwise distinct for generic initial conditions, completing the proof of theorem 2.1. ∞

Reviewing the proof of theorem 2.1, which hinges crucially on the transversality statement (3.4) of our jet perturbation lemma 3.1, we state an easy generalization which is important from an applied viewpoint. Suppose that only $m' \leq m$ profiles (or m' linear combinations) out of the m profiles $u = (u^1, \dots, u^m)(t, x)$ are observable:

$$(4.17) \quad \hat{u} := \hat{P}u,$$

for some linear rank m' projection of \mathbb{R}^m . Then $\hat{u}(t, x; u_0)$ may encounter certain singularities \hat{S}^i in the space \hat{J}_x^k of k -jets with values in range \hat{P} .

COROLLARY 4.2 *Under the assumptions of theorem 2.1 and in the above setting, theorem 2.1 remains valid, verbatim, for singularities $\hat{S}^i \subset \hat{J}_x^k$ of the k -jets $j_x^k \hat{u}(t, x)$ of the observables $\hat{u} := \hat{P}u$. We emphasize that codimensions of \hat{S}^i are then to be computed in \hat{J}_x^k .*

PROOF:

Acting on the dependent variables (u^1, \dots, u^m) , only, the projection \hat{P} lifts to a projection \hat{P}_k from J_x^k onto \hat{J}_x^k such that

$$(4.18) \quad j_x^k \hat{P}u(t, x; u_0) = \hat{P}_k j_x^k u(t, x; u_0)$$

Therefore the surjectivity property (3.4) of lemma 3.1 remains valid for

$$(4.19) \quad D_{u_0} j_x^k \hat{u}(t, x; u_0): X \rightarrow \hat{J}_k.$$

Repeating the proof of theorem 4.1, now on the level of $\hat{u}, \hat{J}_x^k, \hat{S}^i$, proves the corollary. \boxtimes

5 PROOF OF THEOREM 2.2

To prove theorem 2.2 we invoke theorem 2.1 for $x \in \Omega \subset \mathbb{R}^3$, $u(t, x) \in \mathbb{R}^2$, and appropriate singularities $S^i \subset J_x^k$ of singularity codimension 1, in the sense of (2.10).

We first consider the case that 0 is a regular value of $u(t, \cdot)$ on Ω , that is

$$(5.1) \quad \text{rank } u_x(t_0, x_0) = 2$$

is maximal, whenever $u(t_0, x_0) = 0$, $0 < t_0 < t_+(u_0)$, $x_0 \in \Omega$. Then the filament

$$(5.2) \quad \{x \in \Omega \mid u(t_0, x) = 0\}$$

is an embedded curve in Ω , as claimed in (2.18).

Next consider the case

$$(5.3) \quad \text{rank } u_x(t_0, x_0) \leq 1.$$

Let $S \subset J_x^{k=2}$ be the set of those 2-jets $(u, u_x, u_{xx}) \in J_x^{k=2}$ satisfying $u = 0$ and $\text{rank } u_x = 1$. Clearly S is a singularity in the sense of (2.9), (2.10) and

$$(5.4) \quad \text{codim } S = 1$$

as was discussed in example (2.13). We recall that the maximal stratum S_0 of S , determining the codimension, is given by the conditions

$$(5.5) \quad \begin{aligned} \text{rank } u_x &= 1, \\ Pu_{xx}|_E &\text{ nondegenerate.} \end{aligned}$$

Here $E := \ker u_x$ denotes the kernel and P denotes a projection in \mathbb{R}^2 onto a complement of the range of the Jacobian u_x .

In view of example (2.13) and section 1, nondegeneracy of $Pu_{xx}|_E$ gives rise to the three cases (i) - (iii) of corollary 2.2, via theorem 2.1, if only we show that

$$(5.6) \quad Pu_t(t_0, x_0) \neq 0$$

whenever $j_x^2 u(t_0, x_0) \in S$.

By theorem 2.1, we have

$$(5.7) \quad j_x^2 u(\cdot, \cdot) \bar{\cap} S$$

in J_x^2 , at (t_0, x_0) . Evaluating only transversality in the first component $u = 0$ of $j_x^2 u = (u, u_x, u_{xx}) \in J_x^2$, we see that

$$(5.8) \quad \text{rank}(u_t, u_x) = 2$$

at (t_0, x_0) . Since $Pu_x = 0$ by definition of P , this implies

$$(5.9) \quad Pu_t(t_0, x_0) \neq 0$$

and the proof of corollary 2.2 is complete. ∞

6 NUMERICAL MODEL AND METHODS

For our numerical simulations, we use two-variable $N = 2$ reaction-diffusion equations

$$(6.1) \quad \begin{aligned} \partial_t \tilde{u}^1 &= \Delta \tilde{u}^1 + f(\tilde{u}^1, \tilde{u}^2) \\ \partial_t \tilde{u}^2 &= D\Delta \tilde{u}^2 + g(\tilde{u}^1, \tilde{u}^2) \end{aligned}$$

on a square or cube Ω with Neumann boundary conditions. The functions $f(\tilde{u}^1, \tilde{u}^2)$ and $g(\tilde{u}^1, \tilde{u}^2)$ express the local reaction kinetics of the two variables \tilde{u}^1 and \tilde{u}^2 . The diffusion coefficient for the \tilde{u}^1 variable has been scaled to unity, and D is the ratio of diffusion coefficients. For the reaction kinetics we use

$$(6.2) \quad \begin{aligned} f(\tilde{u}^1, \tilde{u}^2) &= \epsilon^{-1} \tilde{u}^1 (1 - \tilde{u}^1) (\tilde{u}^1 - u_{th}(\tilde{u}^2)) \\ g(\tilde{u}^1, \tilde{u}^2) &= \tilde{u}^1 - \tilde{u}^2, \end{aligned}$$

with $u_{th}(\tilde{u}^2) = (\tilde{u}^2 + b)/a$. This choice differs from traditional FitzHugh-Nagumo equations, but facilitates fast computer simulations [11]. In non-autonomous simulations, we periodically force the excitability threshold $b = b(t) = b_0 + A \cos(\omega t)$. We keep most model parameters fixed at $a = 0.8$, $b_0 = 0.01$, $\epsilon = 0.02$, and $D = 0.5$.

Without forcing, the medium is strongly excitable, see figure 1. See figure 2 for the dynamics of a wave train. In two space dimensions, the equations generate rigidly rotating spirals with small cores. These spirals are far from the meander instability, and appropriate initial conditions quickly converge to rotating waves. We map the coordinates $(\tilde{u}^1, \tilde{u}^2)$ into the (u^1, u^2) -coordinates of theorem 2.1 by setting $u^1 = \tilde{u}^1 - 0.5$ and $u^2 = \tilde{u}^2 - (a/2 - b_0)$. We have remarked in the introduction, already, that our results are not effected by such a shift of level sets.

In the autonomous cases we choose a forcing amplitude $A = 0$, of course. For collision of spirals in two dimensions, we choose $A = 0.01, \omega = 3.21$. For collision of scroll wave filaments in three dimensions, we choose $A = 0.01, \omega = 3.92$.

The challenging aspect of computing wave fronts in excitable media is the resolution of both spatial and temporal details of the wave fronts while the interesting global phenomena occur on a much slower time scale. Since both spatial

and temporal resolutions have to be high, the main computational speedup is achieved by minimizing the number of operations necessary per time step and space point.

Simulations with cellular automata encounter problems due to grid isotropies [17, 32, 33]. The existence of persistent spatial wave fronts impedes algorithms with variable time steps. Due to linearity of the spatial operator, methods with fixed, small time steps are feasible. Moreover, \tilde{u}^1 and \tilde{u}^2 can be updated in place away from the wave front.

We use a third-order semi-implicit stepping routine to time step f , combined with explicit Euler time stepping for g and the Laplacian term. In the evaluation of f and in the diffusion of \tilde{u}^1 , we take into account that $\tilde{u}^1 \approx 0$ in a large part of the domain, and that $f(0, \tilde{u}^2) = 0$. This allows a cheap update of approximately half of the grid elements and, even with a straightforward finite-difference method, enables simulation on a workstation. The extra effort of an adaptive grid with frequent re-meshing has been avoided.

In three space dimensions $N = 3$, we use a 19-point stencil with good numerical properties (isotropic error, mild time-step constraint) for approximating the Laplacian operator. In two dimensions $N = 2$, we use the analogous 9-point stencil. Neumann boundary conditions are imposed on all boundaries.

For specific simulation runs in this paper, we take 125^3 grid points. The domain Ω is chosen sufficiently large, in terms of diffusion length, to exhibit scroll wave collision phenomena. The time step Δt is chosen close to maximal: let h denote grid size, $\sigma = 3/8$ the stability limit of the Laplacian stencil, and choose $\Delta t := 0.784\sigma h^2$. This results in the following numerical parameters: domain $\Omega = -[15, 15]^3$, grid spacing $h = 30/124 \approx 1/4$, time step $\Delta t = 0.0172086$, giving $\Delta t/\epsilon = 0.86043$. For high-accuracy studies of the collision of scroll waves, we use a higher resolution of $\Omega = [-10, 10]^3$, $h = 20/124 \approx 1/6$, $\Delta t = 0.00764828$, giving $\Delta t/\epsilon = 0.3882414$. Note that $\Delta t/\epsilon < 1$ in both cases, which means that the temporal dynamics are well resolved. Further numerical details for the three-dimensional simulations are given in [11].

7 FILAMENT VISUALIZATION

After discretization in the cube domain Ω , and time integration, the solution data $u(t, x) \in \mathbb{R}^2$ are given as values $u(t_i, x_i)$ at time steps t_i and at positions x_i on a Cartesian lattice. In our two-dimensional examples, figure 1 and example 8.2, we show the vector field $(\tilde{u}^1, \tilde{u}^2) = (u^1 + 0.5, u^2 + (a/2 - b_0))$, choosing for each point a color vector in RGB space of $(u^1, 0.73 * (u^2)^2, 1.56 * u^2)$. We also mark the (past) trace of the tip path in white, to keep track of the movements of the spiral tip. In figure 3 and example 8.3, we depict the wave front in $x \in \Omega$ as the surface $u^1 = 0$.

To determine the filament location, alias the level set

$$(7.1) \quad \varphi^t := \{x \in \Omega \mid u^1(t, x) = u^2(t, x) = 0\},$$

we use a simplicial algorithm in the spirit of [2, ch. 12].

As in section 6, let $Q \subseteq \Omega$ be any of the small discretization cubes. We triangulate its faces by bisecting diagonals, denoting the resulting closed triangles by τ . The corners of τ are vertices of Q . We orient τ according to the induced orientation of ∂Q by its outward normal ν and the right hand rule applied to (τ, ν) .

By linear interpolation, $u(t, \tau) \subset \mathbb{R}^2$ is also an oriented triangle. The filament φ^t passes through τ , on the discretized level, if and only if $0 \in u(t, \tau)$. Inverting the linear approximation u on τ defines an approximation $\varphi_i^t \in \tau$ to $\varphi^t \cap \tau$. We orient φ^t to leave Q through τ , if the orientation of the triangle $u(t, \tau)$ is positive ("door out"). In the opposite case of negative orientation we say that φ^t enters Q through τ ("door in"). By elementary degree theory, the numbers of in-doors and of out-doors coincide for any small discretization cube Q . Matching in-doors φ_i^t and out-doors $\varphi_{i'}^t$ in pairs defines a piecewise linear, oriented approximation to the filament φ^t . For orientations before and after crossover-collision see figure 4.

Note that here and below, we freely discard certain degenerate, non-generic situations from our discussion which complicate the presentation and tend to confuse the simple issue. In fact, due to homotopy invariance of Brouwer degree, this piecewise linear (PL) method is robust with respect to perturbations of degeneracies like filaments touching a face of the cube Q or repeatedly threading through the same triangle τ .

To indicate the phase near the filament φ_t , we compute a tangential approximation to the accompanying somewhat arbitrary isochrone

$$(7.2) \quad \chi^t := \{x \in \Omega \mid u^1(t, x) \geq 0 = u^2(t, x)\}$$

as follows. The values $(u^1, u^2)(t, x) = (\alpha, 0)$ with $\alpha > 0$ define a local half line in the face triangle $x \in \tau$ through the filament point $\varphi_i^t \in \tau$. Together with a filament point φ_{i-1}^t in another cube face, this half line also defines a half space which approximates the isochrone χ^t , locally. We choose a point $\tilde{\varphi}_i^t$ in this half space, a fixed distance from φ_i^t and such that the line from φ_i^t to $\tilde{\varphi}_i^t$ is orthogonal to the filament line from φ_{i-1}^t to φ_i^t . The sequence of triangles $(\varphi_{i-1}^t, \tilde{\varphi}_{i-1}^t, \tilde{\varphi}_i^t), (\varphi_{i-1}^t, \tilde{\varphi}_i^t, \varphi_i^t)$ then define a triangulated isochrone band approximating χ^t near the filament φ^t .

In practical computations shown in the next section, we distinguish an absolute front and back of the isochrone band by color, independently of camera angle and position. This difference reflects the absolute orientation of filaments, introduced above, which induces an absolute orientation and an absolute normal for the accompanying isochrone χ^t . The absolute normal of the isochrone χ^t also points into the propagation direction of the isochrone, by our choice of orientation.

8 EXAMPLES

In this section we present four simulations of three-dimensional filament dynamics, both in autonomous and in periodically forced cases. All examples are

based on equations (6.1) with the set of nonlinearities and parameters specified there. We use a cube $\Omega = [-15, 15]^3$ as a spatial domain, together with Neumann boundary conditions. Only in example 8.4, we use a smaller cube $\Omega = [-10, 10]^3$. Reflecting the solutions through the boundaries we obtain an extension to the larger cube 2Ω with periodic boundary conditions. Viewing this system on the flat 3-torus T^3 , equivalently, eliminates all boundary conditions and avoids the issue of $\partial\Omega$ not being smooth. In the paper version, each of the spatio-temporal singularities at (t_0, x_0) is illustrated by a series of still shots: $t \gtrsim 0, t \lesssim t_0, t = t_0, t \gtrsim t_0$ and $t = t_{\text{end}}$ for the respective run. In the Internet version, each sequence is replaced by a downloadable animation in MPEG-1 format; see

<http://www.math.fu-berlin.de/~Dynamik/>

For possible later, updated and revised versions, please contact the authors. Discretization was performed by 125^3 cubes and a time step of $\Delta t = 0.0172086$ ($\Delta t = 0.00764828$ in example 8.4); see section 6. Autonomous cases refer to the forcing amplitude $A = 0$, whereas $A = 0.01$ switches on non-autonomous additive forcing.

8.1 INITIAL CONDITIONS

Prescribing approximate initial conditions for colliding scroll waves in three space dimensions is a somewhat delicate issue. We describe the construction in 8.1.1, 8.1.2 below. We discuss our four examples in sections 8.3-8.6.

8.1.1 TWO-DIMENSIONAL SPIRALS

According to our numerical simulations, planar spiral waves are very robust objects. In fact, sufficiently separated nondegenerate zeroes of the planar “vector field” $(u_0^1, u_0^2)(x_1, x_2)$ of initial conditions typically seemed to converge into collections of single-armed spiral waves. Their tips were located nearby the prescribed zeroes of u_0 .

To prepare for our construction of scroll waves below, we nevertheless construct u_0 as a composition of two maps,

$$(8.1) \quad u_0 = \sigma \circ \gamma$$

$$(8.2) \quad \begin{aligned} \gamma: \quad \mathbb{R}^2 \supseteq \Omega &\rightarrow \mathbb{C} \\ (x_1, x_2) &\mapsto z \end{aligned}$$

$$(8.3) \quad \begin{aligned} \sigma: \quad \mathbb{C} &\rightarrow \mathbb{R}^2 \\ z &\mapsto (u_0^1, u_0^2) \end{aligned}$$

Here γ prescribes the geometric location of the spiral tip and wave fronts. The scaling map σ is chosen piecewise linear. It adjusts for the appropriate range of u -values to trace out a wave front cycle in our excitable medium, see fig. 2. Specifically, we choose

$$(8.4) \quad \sigma(z) = (u^1, u^2) = (\operatorname{Re} z, \operatorname{Im} z/4)$$

near the origin. Further away, we cut off by constants as follows:

$$(8.5) \quad \begin{aligned} u^1 &:= \begin{cases} -0.5, & \text{when } \operatorname{Re}(z) < -0.5 \\ \operatorname{Re}(z), & \text{when } \operatorname{Re}(z) \in [-0.5, 0.5] \\ 0.5, & \text{when } \operatorname{Re}(z) > 0.5 \end{cases} \\ u^2 &:= \begin{cases} -0.4, & \text{when } \operatorname{Im}(z) < -1.6 \\ 0.25\operatorname{Im}(z), & \text{when } \operatorname{Im}(z) \in [-1.6, 1.6] \\ 0.4, & \text{when } \operatorname{Im}(z) > 1.6 \end{cases} \end{aligned}$$

In the following, we will sometimes further decompose $\sigma = \sigma_2 \circ \sigma_1$ where

$$(8.6) \quad \sigma_1(z) = (\operatorname{Re}(z), \operatorname{Im}(z)/4)$$

is linear and the clamping $\sigma_2 : \mathbb{R}^2 \rightarrow \mathbb{R}^2$ is the cut-off

$$(8.7) \quad (u^1, u^2) \mapsto (\operatorname{sign}(u^1) \min\{|u^1|, 0.5\}, \operatorname{sign}(u^2) \min\{|u^2|, 0.4\}).$$

For example, this choice of σ , combined with the simplest geometry map $\gamma(x_1, x_2) = x_1 + ix_2$, results in a spiral wave rotating clockwise around the origin, with wave front at $x_1 = 0, x_2 < 0$, initially, and wave back at $x_1 = 0, x_2 > 0$.

A possible initial condition for a spiral — antispiral pair as in example 8.2 below would be

$$\gamma: \begin{array}{ll} [-15, 15]^2 & \rightarrow \mathbb{C} \\ (x_1, x_2) & \mapsto |x_1| - 6 + ix_2. \end{array}$$

This reflection symmetric initial condition creates a pair of spirals rotating around $(\pm 6, 0)$. The spiral at $(6, 0)$ rotates clockwise and the symmetric spiral around $(-6, 0)$ rotates anti-clockwise.

8.1.2 THREE-DIMENSIONAL SCROLLS

It is useful to visualize a three-dimensional scroll wave as a stack foliated by two-dimensional slices which contain planar spirals. Initial conditions $u_0 = \sigma \circ \gamma$ for scroll waves then contain the following ingredients: a mapping $\gamma : \mathbb{R}^3 \rightarrow \mathbb{C}$ that stacks the spirals into the desired three-dimensional geometry, and a scaling $\sigma : \mathbb{C} \rightarrow \mathbb{R}^2$. For planar $\gamma : \mathbb{R}^2 \rightarrow \mathbb{C}$ as in (8.2), the scaling σ of (8.3)–(8.7) generates a spiral whose tip is at the origin in \mathbb{R}^2 . For $\gamma : \mathbb{R}^3 \rightarrow \mathbb{C}$, the preimage in \mathbb{R}^3 of the origin under the stacking map γ will therefore comprise the filament of the three-dimensional scroll wave. For example, it is easy to find a stacking map γ that gives rise to a single straight scroll wave with vertical filament: $\gamma(x_1, x_2, x_3) := x_1 + ix_2$. As soon as filaments are required to form rings, linked rings or knots, however, the design of stacking maps γ with the appropriate zero set becomes more difficult.

For the generation of more complicated stacking maps γ , we largely follow the method pioneered by Winfree et al [37, 18, 39]. This approach uses a standard method of embedding an algebraic knot in 3-space [6]. For convenience of our readers, we briefly recall the construction here.

We construct stacking maps $\gamma: \mathbb{R}^3 \rightarrow \mathbb{C}$ with prescribed, possibly linked or knotted zero set as a composition

$$(8.8) \quad \gamma = p \circ s.$$

Here the embedding $s: \mathbb{R}^3 \rightarrow \mathbb{C}^2$ will be related to the map

$$(8.9) \quad \tilde{s}: \mathbb{R}^3 \rightarrow \mathbb{S}_\varepsilon^3 \subset \mathbb{R}^4 = \mathbb{C}^2$$

denoting the inverse of the standard stereographic projection from the standard 3- sphere \mathbb{S}_ε^3 of radius ε to \mathbb{R}^3 ; see (8.11) below. The map

$$(8.10) \quad p: \mathbb{C}^2 \rightarrow \mathbb{C}$$

is a complex polynomial $p = p(z_1, z_2)$ in two complex variables z_1, z_2 . The zero set of p describes a real, two-dimensional variety V in \mathbb{C}^2 . Consider the intersection $\tilde{\varphi}$ of V with the small 3-sphere \mathbb{S}_ε^3 , that is $\tilde{\varphi} := V \cap \mathbb{S}_\varepsilon^3$. Typically, $\varphi := s^{-1}(\tilde{\varphi}) \subset \mathbb{R}^3$, the zero set of γ , will be a one-dimensional curve or a collection of curves: the desired filament of our scroll wave.

In the simplest case φ may be a circle embedded into the 3-sphere \mathbb{S}_ε^3 . If however zero is a critical point of the polynomial p , then the filament φ need not be a topological circle. And even if $\tilde{\varphi}$ happens to be a topological circle, it may be embedded as a knot in \mathbb{S}_ε^3 .

The inverse stereographic map \tilde{s} is given explicitly by

$$(8.11) \quad \tilde{s}(x_1, x_2, x_3) = \frac{1}{R^2 + \varepsilon^2} \begin{pmatrix} 2\varepsilon^2 x_1 \\ 2\varepsilon^2 x_2 \\ 2\varepsilon^2 x_3 \\ (R^2 - \varepsilon^2)\varepsilon \end{pmatrix} \cong \frac{2\varepsilon^2}{R^2 + \varepsilon^2} \begin{pmatrix} x_1 + ix_2 \\ x_3 + i\frac{(R^2 - \varepsilon^2)}{(2\varepsilon)} \end{pmatrix}$$

where $R^2 \equiv x_1^2 + x_2^2 + x_3^2$. Note that points inside $\mathbb{S}_\varepsilon^2 \subset \mathbb{R}^3$ are mapped to the lower hemisphere, points outside \mathbb{S}_ε^2 to the upper hemisphere of \mathbb{S}_ε^3 .

In our construction (8.8) of the stacking map γ , we now replace the inverse stereographic map \tilde{s} by the embedding

$$(8.12) \quad s(x_1, x_2, x_3) \cong c \begin{pmatrix} x_1 \\ x_2 \\ x_3 \\ (cR^2 - \frac{1}{4c}) \end{pmatrix} \cong \begin{pmatrix} cx_1 + icx_2 \\ cx_3 + i(c^2R^2 - \frac{1}{4}) \end{pmatrix}$$

with a suitable scaling factor c . Clearly $x \rightarrow \infty$ in \mathbb{R}^3 implies $s(x) \rightarrow \infty$ in \mathbb{C}^2 . In the examples 8.5, 8.6 of a pair of linked rings and of a torus knot below, the filaments $\varphi = \gamma^{-1}(0) \cap \Omega$, $\tilde{\varphi} = s(\varphi) = p^{-1}(0) \cap s(\Omega)$ do not intersect the compact boundaries of the cube $\partial\Omega$, $s(\partial\Omega)$, respectively. Therefore,

the embedded paraboloid $s(\mathbb{R}^3)$ can in fact be modified outside $s(\Omega)$ without changing the filaments in Ω . We modify s such that $\text{clos } s(\mathbb{R}^3)$ closes up to a diffeomorphically embedded 3-sphere S diffeotopic to \mathbb{S}^3 in $\mathbb{C}^2 \setminus \{0\}$, by a family s_ϑ of embeddings $0 \leq \vartheta \leq 1$. Moreover, we will choose $p = p(z_1, z_2)$ such that $z_1 = z_2 = 0$ is the only critical point of p in \mathbb{C}^2 . If the embedding $s_\vartheta(\mathbb{R}^3)$ remains transverse to $p^{-1}(0)$ in $\mathbb{C}^2 \setminus \{0\}$ throughout the diffeotopy, then the variety $p^{-1}(0)$ is an embedded real surface in \mathbb{C}^2 , outside $z = 0$. The filament $\tilde{\varphi} = s(\varphi) = p^{-1}(0) \cap s(\Omega)$ is diffeotopic to some components of $p^{-1}(0) \cap \mathbb{S}_\varepsilon^3$, which in turn are described classically in algebraic geometry.

The same remarks apply, slightly more generally, if we replace s by a composition

$$(8.13) \quad s \circ \ell$$

where ℓ denotes a nondegenerate affine transformation in \mathbb{R}^3 .

In summary, we generate our initial conditions by applying the following composition of mappings:

$$(8.14) \quad u_0 = \sigma \circ \gamma = (\sigma_2 \circ \sigma_1) \circ (p \circ s).$$

Here the scaling σ is given by (8.5)–(8.7). The modified stereographic projection s is given by (8.12) with $\ell = \text{id}$, except in example 8.5, and with appropriate scaling constant c . The polynomial p is chosen according to the desired topology of the filament.

The initial conditions thus created do not necessarily respect the boundary conditions; however any intersection of a filament with the boundary is transverse. Anyways, such intersections only occur in example 8.4. Neumann boundary conditions can be enforced artificially, by standard implementation, without introducing additional filaments.

8.2 TWO-DIMENSIONAL SPIRAL PAIR ANNIHILATION

As a preparation to visualizing the three-dimensional behavior, we begin with the collision of a pair of counter-rotating planar spirals. We use a domain $\Omega = [-15, 15]^2$ and discretize with 125^2 grid points, resulting in the same spatial and temporal resolution as with our three-dimensional experiments. In the movie and pictures, we show the subdomain $[-15, 15] \times [-11.25, 11.25]$ to get the 3:4 size ratio typical for video.

For initial conditions, we take the fully developed rigidly rotating spiral of figure 1 with origin at $(-6, 0)$, for the half-plane $x_1 \leq 0$, and reflect at the vertical x_2 -axis. Near-resonant periodic forcing with an amplitude $A = 0.01$ and $\omega = 3.21$ causes the spirals to drift towards each other until they collide. The forcing makes the spiral tips drift on an almost straight, epicyclic trajectory, until they reach interaction distance at time $t = 19.2$. The paths of the tips show that the forcing is strong enough to move the spirals by approximately twice their tip radius per rotation (which is small in comparison to their wave

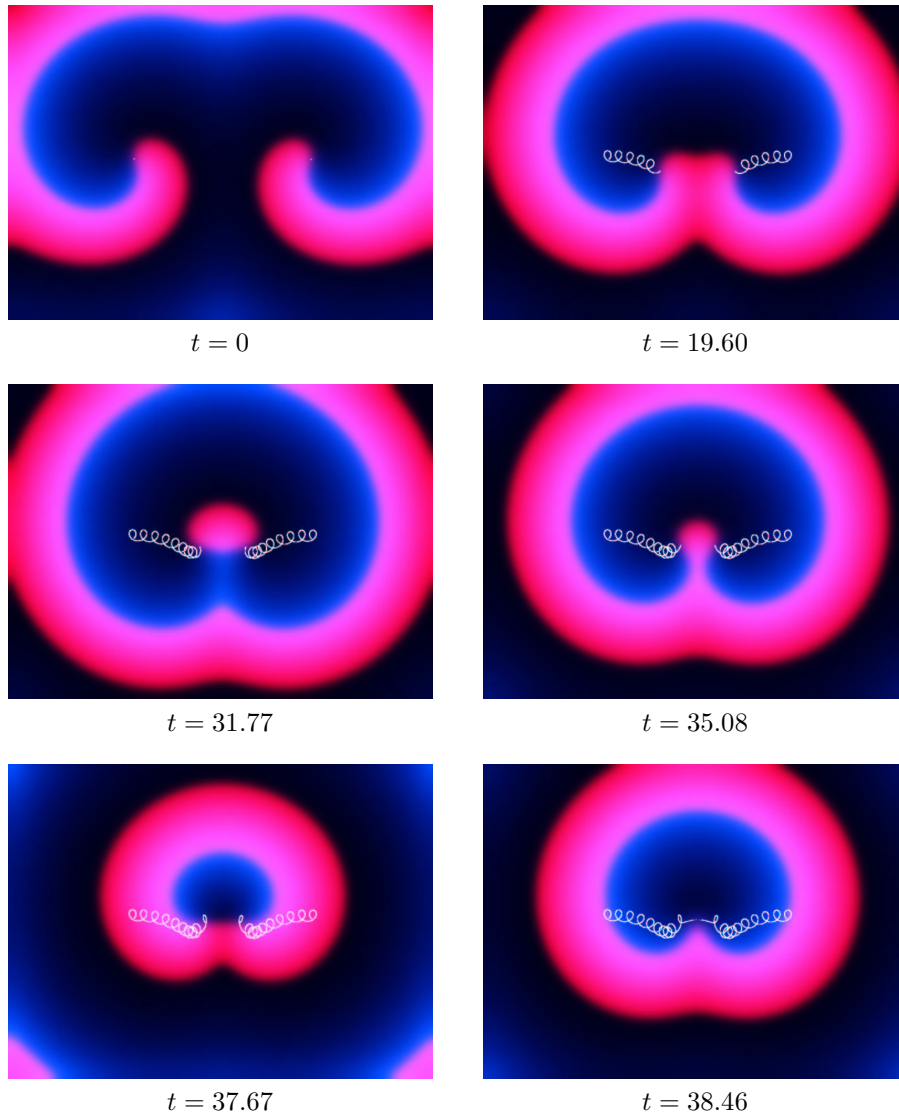

FIGURE 7: Interaction and collision of a pair of spiral waves in the plane.
MPEG-Movie [26.4MB,gzipped]

<http://www.mathematik.uni-bielefeld.de/documenta/vol-05/21.mpeg/twodim.mpg.gz>

length). During the interaction time of the spiral tips, the u^2 gradients are much shallower than at other times. This can be seen by the fact that the bright red part of the wave front is further away from the tip location.

The spirals then wander along the vertical axis, the excited center getting smaller with every revolution. Finally the center is too small to sustain excitation ($t_0 = 39.825$) and disappears; the spirals annihilate. The purely local interaction between the spiral tips shortly before collision from time $t^* = 19.2$ up to the extinction at $t_0 = 39.825, x_0 = (0, 1.4)$ is clearly visible from the tip paths.

In view of theorem 2.1, this annihilation illustrates the left saddle-node singularity of fig. 5 for $\dim u = \dim x = 2$.

8.3 SCROLL RING ANNIHILATION

Our first three-dimensional example shows the disappearance of a closed circular filament as described, from an abstract singularity theory point of view, in theorem 2.2,(ii), and as illustrated in figure 6. The example is autonomous, $A = 0$. Viewed in a vertical planar slice through the center, the dynamics is reminiscent of the two-dimensional spiral pair annihilation 8.2. Instead of periodic forcing, this time, the curvature of the three-dimensional filament seems to be responsible for the filament contraction and annihilation [24].

The simplest initial conditions to create a scroll ring would be via the polynomial $p(z_1, z_2) = z_2$, resulting in the vertical axis $\tilde{s}(\text{Re}z_2) = x_3 = 0$ being a symmetry axis both for u_0 and for $\Omega \subset \mathbb{R}^3$. In order for the initial conditions to be less symmetric with respect to the boundaries of the domain Ω , we apply the translation $\ell\mathbf{x} = \mathbf{x} - \mathbf{x}_*$ with $\mathbf{x}_* = (-1.5, 3, 0)$, and we choose a polynomial p that also depends on z_1 . Our initial conditions are prescribed by (8.14), using

$$(8.15) \quad \begin{aligned} p &= z_2 + 0.1 iz_1, \\ c &= 8/21. \end{aligned}$$

Under discretization, scroll ring annihilation occurs at

$$(8.16) \quad t_0 = 9.10; \quad x_0 = (-1.5, 3.5, -0.5).$$

For illustration/animation see figs. 8.

8.4 CROSSOVER COLLISION OF SCROLL WAVES

We now return to the motivating phenomenon of this paper, outlined in the introduction; see (1.6) and figure 4.

For finer spatial resolution, we choose a smaller domain, $\Omega = [-10, 10]^3$, with discretization into 125^3 cubes. Due to the finer space discretization of $20/124$ instead of $30/124$, we choose a smaller time step of $\Delta t = 0.00764828$. The example is non-autonomous, with forcing amplitude $A = 0.01$ and frequency $\omega = 3.92$. Circumventing the polynomial construction $\gamma = p \circ s$, we take

$$(8.17) \quad \gamma(\tilde{\mathbf{x}}/c) = ((x_3 + \pi/6) + i \sin(x_1))(\sin(x_2) - i(x_3 - \pi/6)),$$

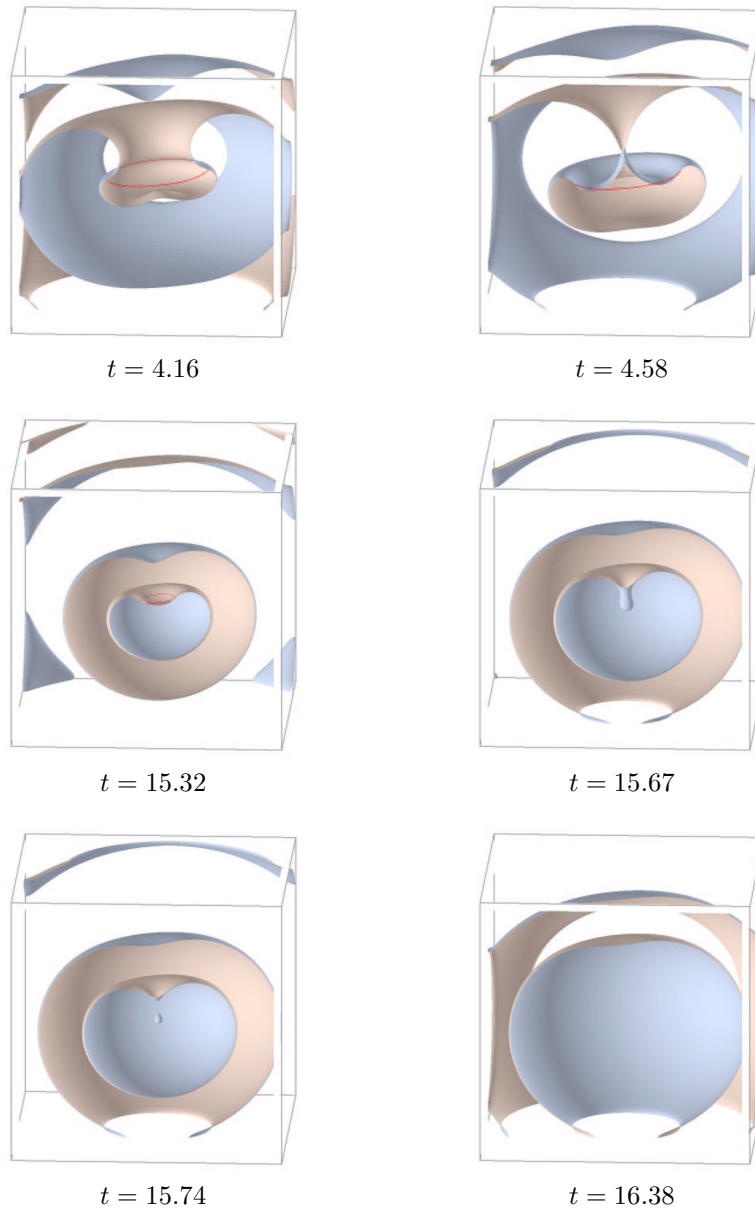

FIGURE 8: Scroll ring annihilation. By $t = 4.2$, a spiral-like cross-section has formed. The scroll ring emits ball shaped target waves twice per revolution, starting at approximately $t = 4.58$. After scroll ring annihilation at $t_0 = 23.45$, the surface $u^1 = 0$ largely follows a concentric target wave pattern rather than a scroll ring pattern. The remaining target waves move outwards, and the medium becomes quiescent.

MPEG-Movie [10.7MB,gzipped]

<http://www.mathematik.uni-bielefeld.de/documenta/vol-05/21.mpeg/ring.mpg.gz>

DOCUMENTA MATHEMATICA 5 (2000) 695–731

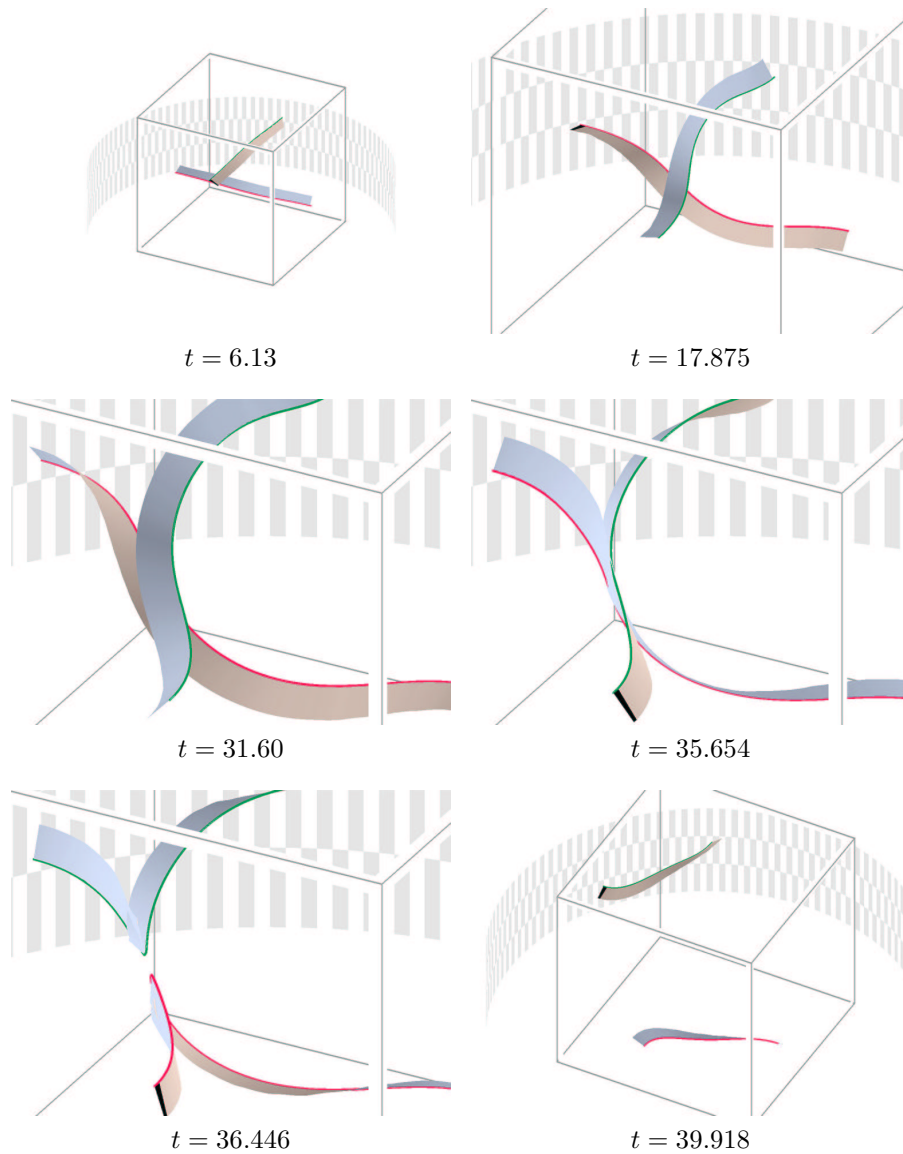

FIGURE 9: Collision of scroll waves: Two scroll wave filaments drift towards each other. After $t = 17$, they start interacting visibly. Around $t = 34$, the filaments have found a common tangent plane and start lining up for collision. The crossover collision occurs at $t_0 = 35.83$, $x_0 = (-3.25, 3.25, 0)$. After collision, the filaments connect adjacent faces of the cube rather than opposite faces.

MPEG-Movie [10.6MB,gzipped]

<http://www.mathematik.uni-bielefeld.de/documenta/vol-05/21.mpeg/scrolls.mpg.gz>

which has zeros in $[-\pi/2, \pi/2]^3$ at $(0, x_2, -\pi/6)$ and at $(x_1, 0, \pi/6)$. Taking $u_0 = \sigma \circ \gamma$, we then start with explicit initial conditions

$$(8.18) \quad \begin{aligned} u_0^1(x) &= \sin(ax_1)(ax_3 - \pi/6) + \sin(ax_2)(ax_3 + \pi/6), \\ u_0^2(x) &= 0.25 * (\sin(ax_1) \sin(ax_2) - (ax_3 + \pi/6)(ax_3 - \pi/6)). \end{aligned}$$

The spatial scaling factor a is chosen as $\pi/20$.

This example was selected because (8.17) has zeroes in $[-\pi/2, \pi/2]^3$ at $(0, x_2, -\pi/6)$ and at $(x_1, 0, \pi/6)$. Then (u_0^1, u_0^2) has zeroes at $(0, \tilde{x}_2, -10/3)$ and at $(\tilde{x}_1, 0, 10/3)$. Therefore, at $t = 0$, filaments are at right angles to each other. Near resonant forcing with amplitude $A = 0.01$ and frequency $\omega = 3.92$ is chosen, together with an appropriate initial phase, such that the filaments drift towards each other and eventually interact.

Under discretization, crossover collision occurs at

$$(8.19) \quad t_0 = 35.83; \quad x_0 = (-3.25, 3.25, 0).$$

For illustration/animation see figures 9 and 10.

Naively, there would be at least two options for non-destructive collision of the two scroll wave filaments. In figures 4, 9 and 10, the two primary filaments are seen to touch, forming a crossing with four emanating semi-branches. Keeping their orientation, the semi-branches could either simply re-connect, as before the collision. Alternatively, they could separate and connect with that semi-branch of matching orientation which they were *not* attached to previously. The first scenario of a crossing collision may be more intuitive at first: the two incoming semi-branches simply reconnect to their previous outgoing partners *without exchanging* their pairing. Such a crossing clearly would not change the global connectivity of the filaments. Viewed in projection onto the tangent plane E at collision time t_0 , however, the filament branches would then have to remain crossing immediately before and after collision time t_0 , in contradiction to both theorem 2.2 and numerical observation in figures 9 and 10.

Note that the filaments, albeit initially straight lines, have to bend out of their way considerably in order to accommodate a generic crossover collision in the tangent plane E . Indeed, initial conditions, periodic forcing, and boundary conditions are all chosen invariant under a rotation by 180° around the axis A which diagonally connects the mid-edge points $(-10, 10, 0)$ and $(10, -10, 0)$ of the domain Ω . This rotation invariance is preserved by the solution $u(t, \cdot)$. Because rotation initially maps one filament into the other, the collision point x_0 must occur on the axis A – and it does, see (8.19). Similarly, the tangent plane E must be orthogonal to A , forming angles of 45° with the straight line initial conditions. We found it fascinating to watch the numerical filaments obey all these predictions.

We caution the reader here that theorems 2.1 and 2.2, as they stand, do not directly apply within restricted classes of symmetric initial conditions. In full generality, the necessary modifications require a restriction to, and analysis of, invariant singularities and their codimensions in spaces of symmetry invariant

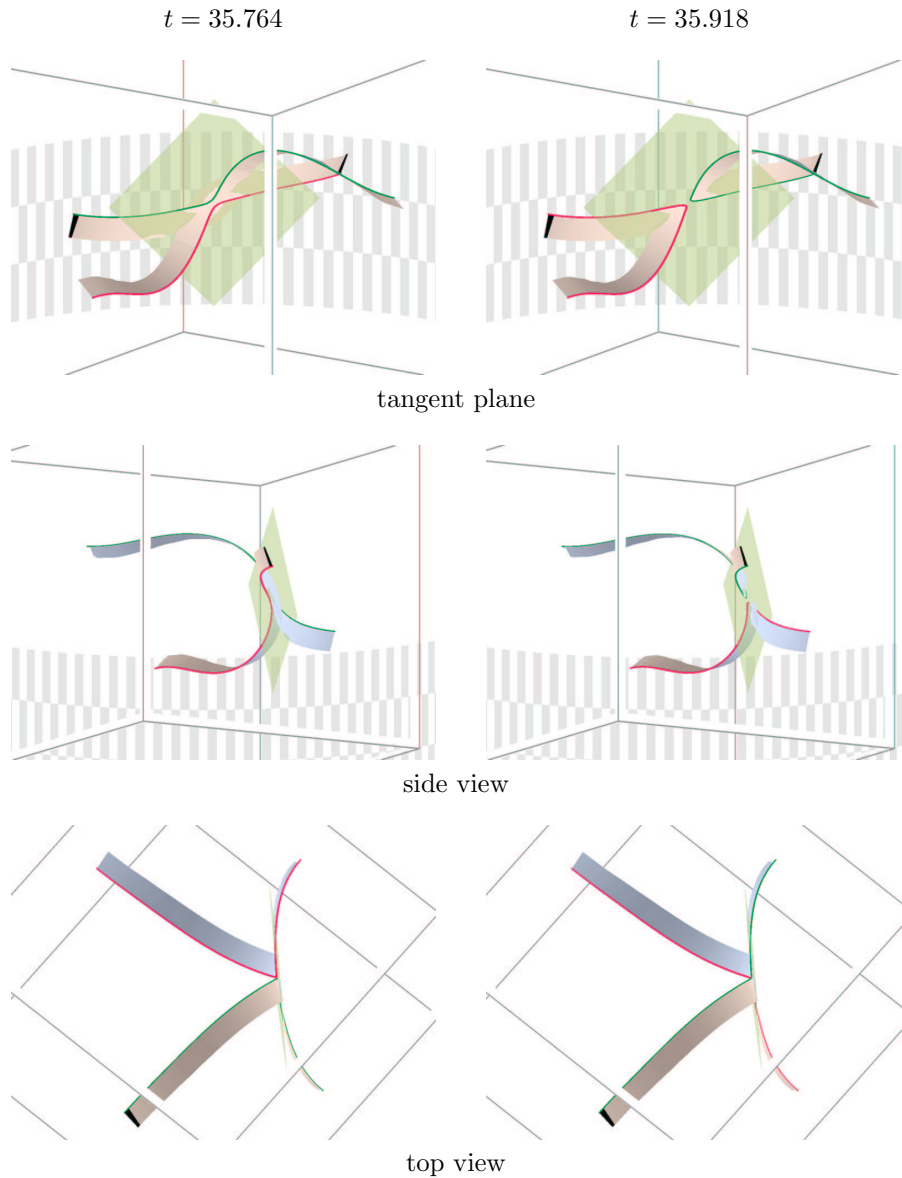

FIGURE 10: Details of the crossover collision: breaking and reconnecting scroll wave filaments, consistently with theorem 2.2. The two incoming semi-branches *exchange* their pairing with the two outgoing semi-branches at $t = t_0$, $x = x_0$. Each incoming semi-branch crosses over to its opposite outgoing semi-branch. The projected branches, when viewed locally in the tangent plane $E = \ker u_x$ to the collision configuration at $t = t_0$, $x = x_0$, neither cross before nor after collision.

MPEG-Movie [10.7MB,gzipped]

<http://www.mathematik.uni-bielefeld.de/documenta/vol-05/21.mpeg/scrollzoom.mpg.gz>

k -jets, again based on transversality, lemma 3.1. The present example and its codimension, however, comply with our simple rotation symmetry. In the coordinates (1.6) of crossover collision this can be seen from invariance under the 180° rotation $(x_1, x_2) \mapsto (-x_1, -x_2)$ around the x_3 axis.

8.5 COLLISION OF LINKED TWISTED SCROLL RINGS

In the previous non-autonomous example we have seen how crossover collisions change the local connectivity of tip filaments. We now present an autonomous example, with forcing amplitude $A = 0$, where two linked filaments merge into a single filament. After collision the resulting filament is neither knotted nor self-linked but is isotopic to a circle.

We start with initial conditions u_0 prescribed by (8.14), with the polynomial $p = z_1^2 - z_2^2$ and stereographic scaling factor $c = 8/21$ in (8.12).

$$(8.20) \quad \begin{aligned} p &= z_1^2 - z_2^2, \\ c &= 8/21. \end{aligned}$$

Under discretization, crossover collision occurs at

$$(8.21) \quad t_0 = 4.90, \quad x_0 = (0, 0, -2.14)$$

For illustration/animation see fig. 11.

We comment on the changes of the global topological characteristics of twist and linking which occur at the crossover collision in this example. See figure 12 for a caricature of the essential features.

To determine the twist of a non self-intersecting closed oriented filament φ^t , we first orient the tip filament φ^t as described in section 7. Then we count the integer winding number of the accompanying isochrone band χ^t around φ^t , according to the right hand rule. The integer twist can be positive, negative, or zero. Next suppose the filament φ^t spans an embedded disk, as all filaments in figures 11, 12 do. The orientation of φ^t induces an orientation of the disk which, again by the right hand rule, we can represent by a field of vectors ν normal to the disk. To any other oriented filament crossing the disk transversely, we associate a crossing sign $+1$, if the crossing is in the direction of ν , and -1 otherwise. Following [40], the sum of crossing signs on the disk adds up to the twist of the boundary filament φ^t .

Applied to the schematic representation of figure 11 in figure 12, we conclude that the two filaments $\varphi_\ell^t, \varphi_r^t$ for $t < t_0$ each have twist -1 . After collision the single remaining filament is untwisted. Our example therefore indicates that one can hope, at best, for a conservation of the parity of the total twist.

8.6 UNKNOTTING THE TREFOIL KNOT BY CROSSOVER COLLISION

In the previous example two linked but unknotted filaments merged into a single filament. Also, the initial conditions were far from a long-term solution

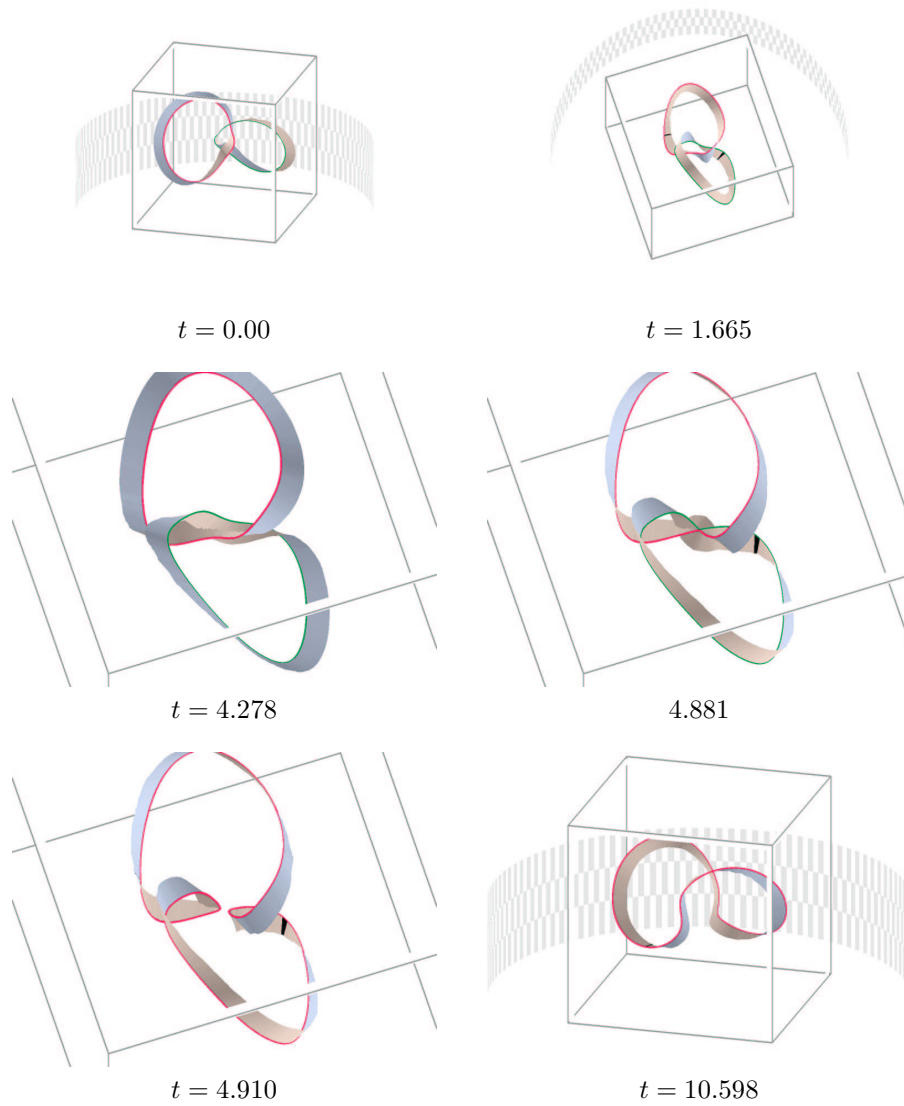

FIGURE 11: Crossover collision of two linked twisted filaments at $t_0 = 4.90$, $x_0 = (0, 0, -2.14)$ into a single untwisted filament.

MPEG-Movie [3.3MB,gzipped]

<http://www.mathematik.uni-bielefeld.de/documenta/vol-05/21.mpeg/rings.mpg.gz>

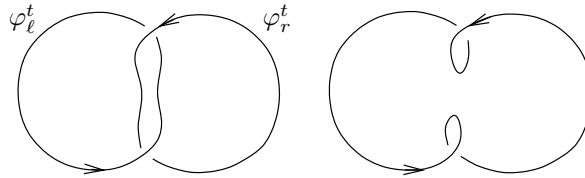

FIGURE 12: A caricature of the crossover collision of two linked, simply twisted filaments $\varphi_\ell^t, \varphi_r^t$ at $t = t_0$. Before collision, each scroll ring possesses a twist of -1 . After collision, the resulting scroll ring is untwisted, globally.

of the equations. In contrast, we now take a trefoil knot as an initial condition that already exhibits fully developed scroll waves. We then rescale space, which is equivalent to a change of diffusion constants. This brings the filaments into sufficiently close contact for interaction.

The initial conditions for this autonomous example, $A = 0$, are the numerical end state of a coarser simulation on a domain $\Omega_1 = [-25, 25]^3$, also running on a numerical grid of 125^3 grid points. The initial condition for the coarser simulation (starting at time $t = -10$) is created using the polynomial $p = z_1^2 - z_2^3$ with stereographic scaling factor $c = 1/5$ in (8.12):

$$(8.22) \quad \begin{aligned} z_1 &= 1/5(x_1 + ix_2); \\ z_2 &= 1/5x_3 + i((x_1^2 + x_2^2 + x_3^2)/5^2 - 1/4); \\ u_0^1(x) &= \operatorname{Re}(z_1^2 - z_2^3) \quad \text{clamped by (8.7);} \\ u_0^2(x) &= 0.25\operatorname{Im}(z_1^2 - z_2^3) \quad \text{clamped by (8.7).} \end{aligned}$$

At time $t = 0$, we stop the simulation, keeping the same numerical data at grid points but rescaling the domain to $\Omega = [-15, 15]^3$. This is the initial condition at $t = 0$.

Under discretization, crossover collision from a trefoil knot to two linked rings is observed at

$$(8.23) \quad t_0 = 8.94, \quad x_0 = (0, 0, -9.28)$$

For illustration/animation see figure 13. Again we provide a caricature in figure 14.

8.7 DISCUSSION OF EXAMPLES

We conclude our series of examples with some remarks. Concerning example 8.3 of scroll ring annihilation we observe that only untwisted scroll rings can be directly annihilated. This follows from the normal form of the corresponding singularity with positive definite quadratic form $\langle Pu_t, Pu_{xx}|_E \rangle$ at (t_0, x_0) ; see section 1. More globally, it also follows from the observation that the shrinking disk spanned by a circular filament near annihilation is not traversed by other filaments. Indeed a filament shrinking around another, large filament would

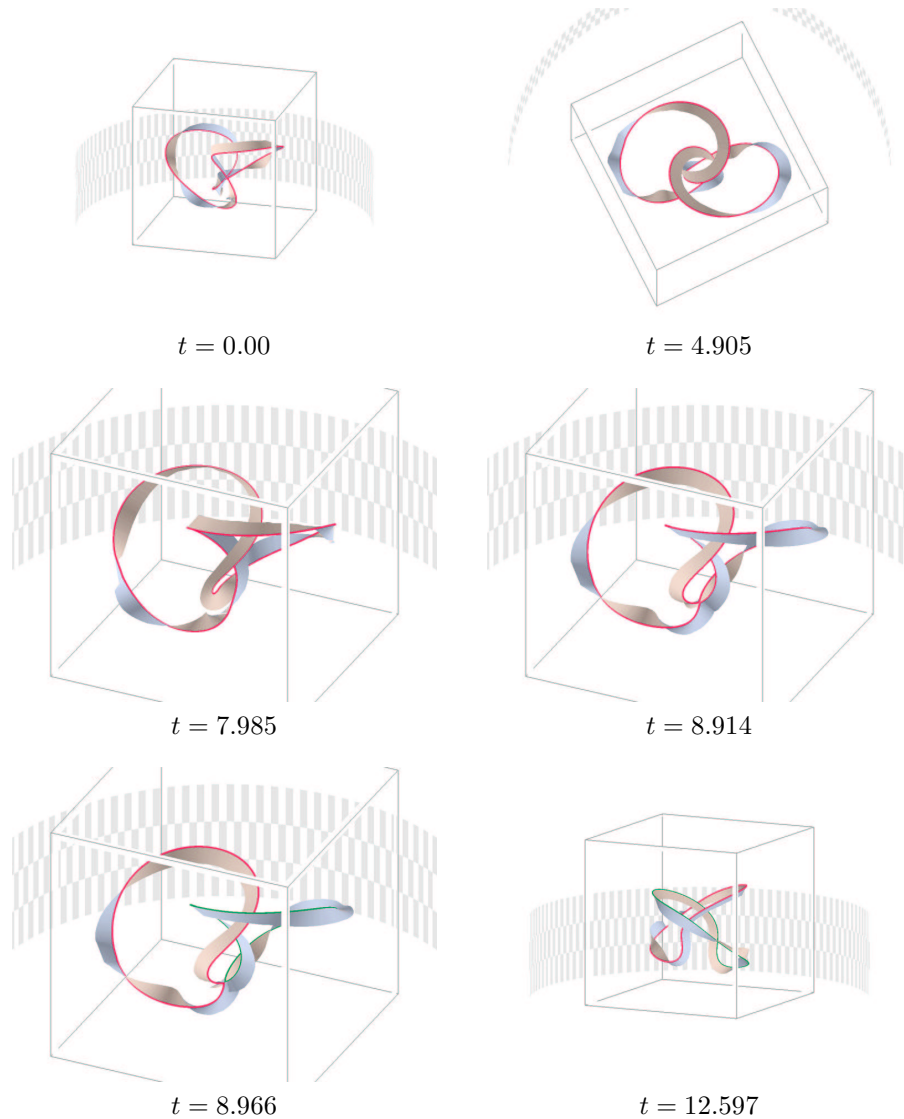

FIGURE 13: Decomposing the trefoil knot into two linked twisted unknotted filaments by crossover collision at $t_0 = 8.94$, $x_0 = (0, 0, -9.28)$. As explained in example 8.3, we see in figures 13, 14 how the trefoil knot with twist ± 3 decomposes into two unknotted, but mutually linked twisted filaments, each of twist -1 .

MPEG-Movie [8.9MB,gzipped]

<http://www.mathematik.uni-bielefeld.de/documenta/vol-05/21.mpeg/knot.mpg.gz>

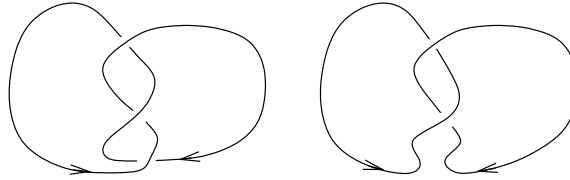

FIGURE 14: A caricature of the unknotting of the trefoil knot, showing the orientations of all filaments.

require a three-dimensional kernel and hence a singularity of codimension at least six.

We have not presented an example for the process opposing annihilation: the creation of a circular filament by a negative definite quadratic form $\langle Pu_t, Pu_{xx}|_E \rangle$ at (t_0, x_0) . Since the definiteness required for $Pu_{xx}|_E$ does not predetermine the direction of Δu , we could construct initial conditions $u_0(x)$ corresponding to scroll ring creation at $t_0 = 0, x_0 \in \Omega$. Although we expect scroll ring creation to be feasible also for large positive times t_0 , we did not observe this phenomenon in our simulations so far.

Our results provide specific examples of the “internal” collision type, which [31] have described as topologically viable; furthermore, we show that crossover collision is the only generic way for scroll waves to change their topological linking type.

From a modeling point of view, experimental systems may require substantially more than just two dependent variables u^1, u^2 for an adequate description by parabolic reaction diffusion systems. We repeat that theorem 4.2 predicts the described two-variable phenomena to occur in any projection setting, where only two combinations of the relevant quantities u^1, \dots, u^m are observable, for example by color shading. We emphasize that this observation neither requires, nor corresponds to, a dynamic reduction of the full underlying reaction diffusion system by inertial manifolds or related techniques of dimension reduction.

Aiming at the ubiquitous wealth of phenomena of pattern formation and pattern transformation, our paper has detected and addressed just a few elementary dynamic effects peculiar to systems of two equations in three space dimensions. Clearly, the theoretical framework supports significantly more complicated spatio-temporal effects than were presented here. Applicability hopefully also will reach far beyond the specific motivating context of Belousov-Zhabotinsky patterns or excitable media.

REFERENCES

- [1] R. Abraham and J. Robbin. *Transversal Mappings and Flows*. Benjamin, New York, 1967.
- [2] E. L. Allgower and K. Georg. *Numerical Continuation Methods. An Introduction*. Springer-Verlag, Berlin, 1990.

- [3] S. Angenent. The zero set of a solution of a parabolic equation *Crelle J. reine angew. Math.*, 390:79–96, 1988.
- [4] D. Barkley. Spiral meandering. In *Chemical Waves and Patterns*, R. Kapral and K. Showalter (eds.), 163–190. Kluwer, 1995.
- [5] D. Barkley, M. Kness, and L. S. Tuckerman. Spiral-wave dynamics in a simple model of excitable media - the transition from simple to compound rotation. *Phys. Rev. A*, 42:2489–2492, 1990.
- [6] K. Brauner. Zur Geometrie der Funktionen zweier komplexer Veränderlicher iii,iv. *Abh. Math. Sem. Hamburg*, 6:8–54, 1928.
- [7] J. Damon. Local Morse theory for solutions to the heat equation and Gaussian blurring. *J. Diff. Eqns.*, 115:368–401, 1995.
- [8] J. Damon. Generic properties of solutions to partial differential equations. *Arch. Rat. Mech. Analysis*, 140:353–403, 1997.
- [9] J. Damon. Singularities with scale threshold and discrete functions exhibiting generic properties. *Mat. Contemp.*, 12:45–65, 1997.
- [10] J. Dieudonné. *Elements d'Analyse 2*. Gauthier-Villars, Paris, 1969.
- [11] M. Dowle, R. M. Mantel, and D. Barkley. Fast simulations of waves in three-dimensional excitable media. *Int. J. Bifur. Chaos*, 7:2529–2546, 1997.
- [12] B. Fiedler and C. Rocha. Orbit equivalence of global attractors of semilinear parabolic differential equations. *Trans. Amer. Math. Soc.*, 352:257–284, 2000.
- [13] B. Fiedler and D. Turaev. Normal forms, resonances, and meandering tip motions near relative equilibria of Euclidean group actions. *Arch. Rat. Mech. Analysis*, 145:129–159, 1998.
- [14] A. Friedman. *Partial Differential Equations*. Holt, Reinhart & Winston, New York, 1969.
- [15] M. Golubitsky and D. G. Schaeffer. *Singularities and Groups in Bifurcation Theory I*. Appl. Math. Sc. 51, Springer-Verlag, 1985.
- [16] D. Henry. *Geometric Theory of Semilinear Parabolic Equations*. Springer-Verlag, Berlin, 1981.
- [17] C. Henze and J. J. Tyson. Cellular-automaton model of 3-dimensional excitable media. *J. Chem. Soc. Farad. Transac.*, 92:2883–2895, 1996.
- [18] C. Henze and A.T. Winfree. A stable knotted singularity in an excitable medium. *Int. J. Bif. Chaos*, 1:891–922, 1991.
- [19] M. W. Hirsch. *Differential Topology*. Springer-Verlag, New York, 1976.
- [20] W. Jahnke, C. Henze, and A. T. Winfree. Chemical vortex dynamics in 3-dimensional excitable media. *Nature*, 336:662–665, 1988.

- [21] O. A. Ladyzhenskaja, V. A. Solonnikov, and N. N. Ural'ceva. *Linear and Quasilinear Equations of Parabolic Type*. Moscow, 1967. English: AMS, Providence, 1968.
- [22] R. M. Mantel and D. Barkley. Periodic forcing of scroll-wave patterns in three-dimensional excitable media. Preprint, University of Minnesota, IMA #1568, 1998.
- [23] H. Matano. Nonincrease of the lap-number of a solution for a one-dimensional semi-linear parabolic equation. *J. Fac. Sci. Univ. Tokyo Sec. IA*, 29:401–441, 1982.
- [24] A. V. Panfilov, A. N. Rudenko, and V. I. Krinsky. Turbulent rings in 3-dimensional active media with diffusion by 2 components. *Biofizika*, 31:850–854, 1986.
- [25] A. V. Panfilov and A. T. Winfree. Dynamical simulations of twisted scroll rings in 3-dimensional excitable media. *Physica D*, 17:323–330, 1985.
- [26] A. Pazy. *Semigroups of Linear Operators and Applications to Partial Differential Equations*. Springer-Verlag, New York, 1983.
- [27] D.G. Schaeffer. A regularity theorem for conservation laws. *Adv. Math.*, 11:368–386, 1973.
- [28] C. Sturm. Sur une classe d'equations a difference partielles. *J. Math. Pure Appl.*, 1:373–444, 1836.
- [29] H. Tanabe. *Equations of Evolution*. Pitman, London, 1979.
- [30] R. Thom. Un lemma sur les applications differentiables. *Bol. Soc. Mat. Mex.*, 2:59–71, 1956.
- [31] J. J. Tyson and S. H. Strogatz. The differential geometry of scroll waves. *Int. J. Bif. Chaos*, 1:723–744, 1991.
- [32] J. R. Weimar, J. J. Tyson, and L. T. Watson. 3rd generation cellular automaton for modeling excitable media. *Physica D*, 55:328–339, 1992.
- [33] J. R. Weimar, J. J. Tyson, and L. T. Watson. Diffusion and wave-propagation in cellular automaton models of excitable media. *Physica D*, 55:309–327, 1992.
- [34] N. Wiener, A. Rosenblueth. The mathematical formulation of the problem of conduction of impulses in a network of connected excitable elements, specifically in cardiac muscle. *Arch. Inst. Cardiol. Mexico*, 16:205–265, 1946.
- [35] A. T. Winfree. Spiral waves of chemical activity. *Science*, 175:634–636, 1972.
- [36] A. T. Winfree. Scroll-shaped waves of chemical activity in three dimensions. *Science*, 181:937–939, 1973.
- [37] A. T. Winfree. *When Time Breaks Down*. Princeton Univ. Press, Princeton, NJ, 1987.

- [38] A. T. Winfree. Varieties of spiral wave behavior: An experimentalist's approach to the theory of excitable media. *Chaos*, 1:303–334, 1991.
- [39] A. T. Winfree. Persistent tangles of vortex rings in excitable media. *Physica D*, 84:126–147, 1995.
- [40] A. T. Winfree, E. M. Winfree, and M. Seifert. Organizing centers in a cellular excitable medium. *Physica D*, 17:109–115, 1985.

Bernold Fiedler
Institut für Mathematik I
Freie Universität Berlin
Arnimallee 2-6
D-14195 Berlin, Germany
fiedler@math.fu-berlin.de

Rolf M. Mantel
Philipps-Universität Marburg
Fachbereich Mathematik und Informatik
Hans-Meerwein Str.
35032 Marburg
mantel@mathematik.uni-marburg.de

