

*Research Article*

**Numerical Exploration of Kaldorian Macrodynamics:  
Hopf-Neimark Bifurcations and Business Cycles with Fixed  
Exchange Rates**

Toichiro Asada, Christos Douskos, and Panagiotis Markellos

Received 15 June 2006; Accepted 9 February 2007

We explore numerically a three-dimensional discrete-time Kaldorian macrodynamic model in an open economy with fixed exchange rates, focusing on the effects of variation of the model parameters, the speed of adjustment of the goods market  $\alpha$ , and the degree of capital mobility  $\beta$  on the stability of equilibrium and on the existence of business cycles. We determine the stability region in the parameter space and find that increase of  $\alpha$  destabilizes the equilibrium more quickly than increase of  $\beta$ . We determine the Hopf-Neimark bifurcation curve along which business cycles are generated, and discuss briefly the occurrence of Arnold tongues. Bifurcation and Lyapunov exponent diagrams are computed providing information on the emergence, persistence, and amplitude of the cycles and illustrating the complex dynamics involved. Examples of cycles and other attractors are presented. Finally, we discuss a two-dimensional variation of the model related to a “wealth effect,” called model 2, and show that in this case,  $\alpha$  does not destabilize the equilibrium more quickly than  $\beta$ , and that a Hopf-Neimark bifurcation curve does not exist in the parameter space, therefore model 2 does not produce cycles.

Copyright © 2007 Toichiro Asada et al. This is an open access article distributed under the Creative Commons Attribution License, which permits unrestricted use, distribution, and reproduction in any medium, provided the original work is properly cited.

**1. Introduction**

The Kaldorian business cycle theory based on the original idea of Kaldor [6] has been developed recently by Lorenz [7], Gandolfo [9], Agliari and Dieci [1], and others. For a general discussion of analytical and numerical methods in the study of nonlinear dynamical systems in economics, we refer to Lorenz [8]. In this paper, we consider a three-dimensional discrete-time model of an open economy with fixed exchange rates. The model is in fact the Kaldorian small open economy model with money and fixed exchange rates, expressed by Asada et al. [3] as a three-dimensional system of nonlinear difference

equations. A similar model in continuous time was studied by Asada [2]. Nonlinearities of the model are considered to be responsible for the explicability of the occurrence of cycles as an endogenous feature of the economy.

The present work is an extension of the work presented by Asada et al. [3]. We explore the model numerically focusing on the phenomenon of dynamical behavior referred to as business cycles. We consider the effects of the changes of parameter values on the stability of equilibrium of the system and determine the stability region in the parameter space. We identify the Hopf bifurcation curve as part of the boundary of this region, and compute bifurcation and Lyapunov exponent diagrams, as our main tools of investigation, to obtain information on the occurrence, amplitude size, and persistence of the business cycles and on the type of bifurcations responsible for their occurrence. The model exhibits complex dynamics and is sensitive to parameter changes. Certain conclusions are drawn regarding the effects of parameter changes on the stability of equilibrium and on the size and persistence of stable cycles. These are found to occur through supercritical bifurcations. Examples of cyclical fluctuations and chaotic behavior of the economic variables are presented.

The term “cycle” traditionally implies periodic orbit, but such an orbit in a discrete dynamical system appears as a set of fixed points visited periodically. In this paper, the term is used for an attracting closed curve corresponding to a quasiperiodic trajectory (or a periodic trajectory of very large period in so far as these two cases may be numerically indistinguishable). The terms “business cycle” and “cyclical attractor” are also used for the same concept.

The paper is organized as follows. In Section 2, we present the equations of the model and the specifications adopted. In Sections 3 and 4, we determine the position and stability of equilibrium, identify the Hopf-Neimark bifurcation curve as part of the boundary of the stability region, and consider the generation of cycles on this curve and the possibility of appearance of Arnold tongues. The results of our exploration of the occurring cyclical and other types of asymptotic dynamical behavior of the model are presented, in the form of diagrams, and discussed in Sections 5 and 6. In Section 7, we consider a special case of the model, called model 2, and show that this does not generate business cycles but produces period-doubling cascades. Section 8 concludes the paper.

## 2. Model equations: variables and parameters

We consider the three-dimensional model of open economy Kaldorian dynamics proposed by Asada et al. [3]. This is obtained from the following system of equations:

$$Y(t+1) - Y(t) = \alpha[C(t) + I(t) + G + J(t) - Y(t)], \quad \alpha > 0, \quad (2.1)$$

$$K(t+1) - K(t) = I(t), \quad (2.2)$$

$$C(t) = c[Y(t) - T(t)] + C_0, \quad 0 < c < 1, C_0 > 0, \quad (2.3)$$

$$I(t) = I[Y(t), K(t), r(t)], \quad \frac{\partial I}{\partial Y} > 0, \quad \frac{\partial I}{\partial K} < 0, \quad \frac{\partial I}{\partial r} < 0, \quad (2.4)$$

$$T(t) = \tau Y(t) - T_0, \quad 0 < \tau < 1, T_0 > 0, \quad (2.5)$$

$$M(t) = pL[Y(t), r(t)], \quad \frac{\partial L}{\partial Y} > 0, \quad \frac{\partial L}{\partial r} < 0, \quad (2.6)$$

$$J(t) = J[Y(t), E], \quad \frac{\partial J}{\partial Y} < 0, \quad \frac{\partial J}{\partial E} > 0, \quad (2.7)$$

$$Q(t) = \beta \left[ r(t) - r_f - \frac{E^e(t) - E(t)}{E(t)} \right], \quad \beta > 0, \quad (2.8)$$

$$A(t) = J(t) + Q(t), \quad (2.9)$$

$$M(t+1) - M(t) = pA(t), \quad (2.10)$$

$$E(t) = E^e(t) = \bar{E}, \quad (2.11)$$

where  $t$  denotes the time period and the meanings of the symbols are as follows:  $Y$  = net real national income,  $C$  = real consumption expenditure,  $K$  = real physical capital stock,  $T$  = real income tax,  $M$  = nominal money supply,  $I$  = net real private investment expenditure on physical capital,  $G$  = real government expenditure (fixed),  $p$  = price level (fixed),  $E$  = exchange rate (fixed) =  $\bar{E}$ ,  $E^e$  = expected exchange rate (fixed) =  $\bar{E}$ ,  $J$  = balance of current account (net export) in real terms,  $Q$  = balance of capital account in real terms,  $A = J + Q$  = total balance of payments in real terms,  $r$  = nominal rate of interest,  $r_f$  = nominal foreign rate of interest (fixed),  $\alpha$  = adjustment speed of the goods market, and  $\beta$  = degree of capital mobility.

The first three equations (2.1), (2.2), (2.3) are, respectively, the Kaldorian adjustment equation of the goods market, the equation of capital accumulation, and the standard Keynesian consumption function. Equation (2.4) is the Kaldorian investment function. Equations (2.5) and (2.6) are the tax function and the condition of equilibrium for the money market, respectively. The current account equation, the capital account equation, and the definition of the total balance of payments are (2.7), (2.8), and (2.9), respectively. Equation (2.10) expresses that money supply changes endogenously according to whether the total balance of payments is positive or negative under fixed exchange rates. Finally, (2.11) expresses the institutional arrangements of the system of fixed exchange rates. For simplicity, the price level is considered fixed. The dynamical system can be described by the following equations:

$$\begin{aligned} Y(t+1) - Y(t) &= \alpha [c(1 - \tau)Y(t) + cT_0 + C_0 + G \\ &\quad + I\{Y(t), K(t), r[Y(t), M(t)]\} + J[Y(t), \bar{E}] - Y(t)], \\ K(t+1) - K(t) &= I[Y(t), K(t), r(Y(t), M(t))], \\ M(t+1) - M(t) &= pJ[Y(t), \bar{E}] + \beta p \{r[Y(t), M(t)] - r_f\}. \end{aligned} \quad (2.12)$$

In the present paper, we adopt the same specifications as in Asada et al. [3]:

$$\begin{aligned} I[Y(t), K(t), r(t)] &= f(r(t)) - 0.3K(t) - r(t) + 147, \\ r(t) = r[Y(t), M(t)] &= 10\sqrt{Y(t)} - M(t), \end{aligned}$$

#### 4 Discrete Dynamics in Nature and Society

$$\begin{aligned}
 J[Y(t), \bar{E}] &= -0.3Y(t) + 50, \\
 c &= 0.8, \quad \tau = 0.2, \quad p = 1, \quad r_f = 6, \\
 cT_0 + C_0 + G &= 115,
 \end{aligned} \tag{2.13}$$

obtaining the dynamical system described by the three nonlinear difference equations

$$Y_{t+1} - Y_t = F_1 = \alpha \left[ -0.66Y_t + f(Y_t) - 0.3K_t + 147 - 10\sqrt{Y_t} + M_t + 165 \right], \tag{2.14}$$

$$K_{t+1} - K_t = F_2 = f(Y_t) - 0.3K_t + 147 - 10\sqrt{Y_t} + M_t, \tag{2.15}$$

$$M_{t+1} - M_t = F_3 = -0.3Y_t + 50 + \beta \left( 10\sqrt{Y_t} - M_t - 6 \right). \tag{2.16}$$

This system is called model 1 to distinguish it from its variant, called model 2, which we consider in Section 7. The function  $f$  is a particular case of the Kaldorian S-shaped direct dependence of the investment function on income (see also Dohtani et al. [5], Agliari and Dieci [1]) given by

$$f(x) = \frac{80}{\pi} \arctan \left[ \frac{2.25\pi}{20} \left( x - \frac{165}{0.66} \right) \right] + 35. \tag{2.17}$$

### 3. Stability of equilibrium

It is easily seen that the system is in equilibrium at

$$Y^* = 250, \quad K^* = \frac{1760}{3} - \frac{250}{3\beta}, \quad M^* = 50\sqrt{10} - 6 - \frac{25}{\beta}. \tag{3.1}$$

It follows that for  $K^*$  and  $M^*$  to be positive, we must have  $\beta > \beta_{01} = 25/176 \cong 0.142$  and  $\beta > \beta_{02} = 25/(50\sqrt{10} - 6) \cong 0.164$ , respectively. Since  $\beta_{02} > \beta_{01}$ , the condition  $\beta > \beta_{02}$  is sufficient for positive equilibrium. Stability of the equilibrium is determined by the roots of the characteristic polynomial of the Jacobian of the mapping

$$\begin{pmatrix}
 1 + \frac{\partial F_1}{\partial Y} & \frac{\partial F_1}{\partial K} & \frac{\partial F_1}{\partial M} \\
 \frac{\partial F_2}{\partial Y} & 1 + \frac{\partial F_2}{\partial K} & \frac{\partial F_2}{\partial M} \\
 \frac{\partial F_3}{\partial Y} & \frac{\partial F_3}{\partial K} & 1 + \frac{\partial F_3}{\partial M}
 \end{pmatrix}, \tag{3.2}$$

evaluated at the equilibrium. The characteristic polynomial is of the form

$$P_3(\lambda) = \lambda^3 + a_2\lambda^2 + a_1\lambda + a_0 = 0, \tag{3.3}$$

and the Cohn-Shur conditions for stability are

$$1 + a_1 - |a_2 + a_0| > 0, \quad 1 - a_1 + a_2a_0 - a_0^2 > 0, \tag{3.4}$$

$$a_1 < 3. \tag{3.5}$$

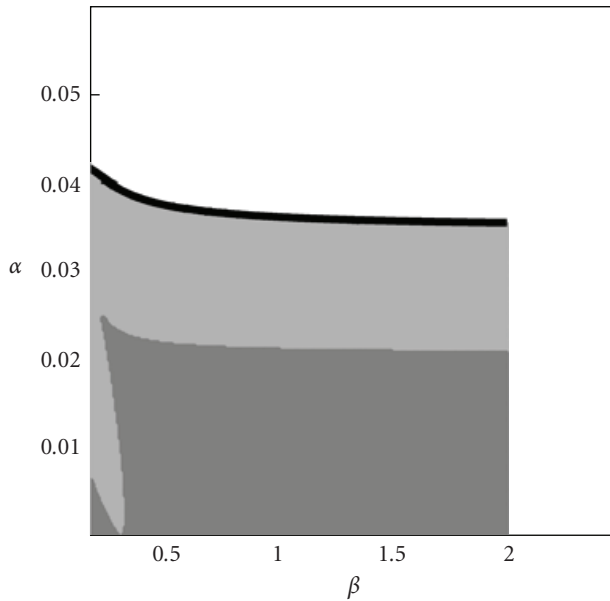

Figure 3.1. Region of stability of the equilibrium and the Hopf-Neimark bifurcation curve (bold) in the  $(\beta, \alpha)$  parameter plane.

Gandolfo [9, page 90] asserted that condition (3.5) is redundant. But, in fact, this condition is not redundant. This can be seen by the counterexample  $\lambda^3 - 7\lambda^2 + 12\lambda - 4$  (with one root = 2) given by J. Minagawa. These conditions represent relations between the parameters  $\beta$  and  $\alpha$  of the model which are satisfied in the shaded region of the  $(\beta, \alpha)$  plane shown in Figure 3.1. Note that we consider only cases of positive equilibrium, therefore the stability diagram is given in this figure for  $\beta > \beta_{02}$ . The upper right-hand “corner” of the boundary of the stability region is at the point  $(\beta \cong 1.994, \alpha \cong 0.0358)$ .

By Asada et al. [3], the conclusion was drawn by analytical considerations regarding the stability of the system that under certain conditions, the increase of the adjustment speed of the goods market  $\alpha$  and the degree of capital mobility  $\beta$  tends to destabilize the system of fixed exchange rates, in the sense that the equilibrium point becomes unstable for sufficiently large  $\alpha$  and  $\beta$ . In the present paper, we see that in fact for the specifications adopted in the present formulation of the model, increase of the parameter  $\alpha$  destabilizes the equilibrium quickly, at  $\alpha \cong 0.04$ , while increase of the parameter  $\beta$  destabilizes the equilibrium less quickly, at  $\beta \cong 2$ , and does not appreciably affect the destabilization process caused by increasing  $\alpha$ . In other words, destabilization due to  $\alpha$  occurs early at values near  $\alpha = 0.04$  regardless of the value of  $\beta (< 2)$ . We recall that a small value of  $\alpha (< 1)$  means prudent reaction by firms, while a large value ( $\alpha > 1$ ) means rash reaction and coordination failure (see Agliari and Dieci [1]). Thus, one might venture to interpret the stability region by saying that considerable capital movement does not destabilize the system, so long as firms are very prudent in their reactions.

#### 4. Generation of business cycles and Arnold tongues

With regard to our aim to explore the generation of business cycles in the present model, we note the following facts well established in the literature for two-dimensional systems. Cyclical fluctuations may be generated on a Hopf bifurcation curve. This is a curve in the parameter space with the property of being a boundary of the stability region on which two roots of the characteristic polynomial are complex conjugates, and when this curve is crossed these roots cross the unit circle in the complex plane. In the case of a supercritical Hopf bifurcation, under certain conditions a stable cycle is generated on this curve when the equilibrium point loses stability in this way. This is a local bifurcation in which the cycle is born out of the equilibrium point in a continuous manner. Initially, it has infinitesimally small amplitude, increasing gradually. In this case, the cycle exists only outside the stability region, replacing the equilibrium point as an attractor. For extensive discussions on the Hopf-Neimark bifurcation in economic models, we refer to Gandolfo [9] and Puu [10].

In our search for a Hopf-Neimark bifurcation curve, we first look for the region in the parameter space where two roots of the characteristic polynomial are complex-conjugates. In the present model, this happens in the light-shaded part of the stability region. We have established numerically that only the part of the stability boundary relevant to this region shown bold in Figure 3.1 is a Hopf-Neimark bifurcation curve. Limit cycles are generated when this curve is crossed in the  $(\beta, \alpha)$  plane, as the complex roots then cross the unit circle in the complex plane. The bifurcations are found to be of the supercritical type.

Let us now consider the occurrence of cyclical fluctuations on the bifurcation curve in relation to the appearance of Arnold tongues. At the bifurcation curve, the complex roots of the characteristic polynomial are on the unit circle:  $\lambda_{1,2} = a \pm ib$ ,  $b \neq 0$ ,  $a^2 + b^2 = 1$ , so we can write

$$\lambda_{1,2} = \cos \phi \pm i \sin \phi. \quad (4.1)$$

In general, for supercritical bifurcations as in the present case, we have  $\phi \neq 2\pi p/q$  ( $p, q$  integers) and the equilibrium point bifurcates into a limit cycle. This is ensured theoretically in the case of two dimensions and in the absence of strong resonances ( $q \neq 2, 3, 4$ ). When a resonance is met, we have  $\phi = 2\pi p/q$  and the bifurcation is from a single equilibrium point to a set of  $q$  period- $q$  equilibrium points, generating an Arnold tongue corresponding to periodic points of period  $q$  (for a discussion of Arnold tongues, see, e.g., Puu [10]). In the present case, we have determined numerically that along the Hopf-Neimark bifurcation curve, strong resonances do not occur. This is done by calculating the quantity  $p/q = (1/2\pi) \arccos a$  along the entire curve. We then obtain the plot of Figure 4.1 showing some of the lowest resonances occurring, and note that the lowest resonance found for  $q < 60$  is  $p/q = 1/59$ . This provides numerical evidence that in so far as the relevant two-dimensional theory is carried over to three dimensions, in the present case only Arnold tongues of period  $> 58$  will appear.

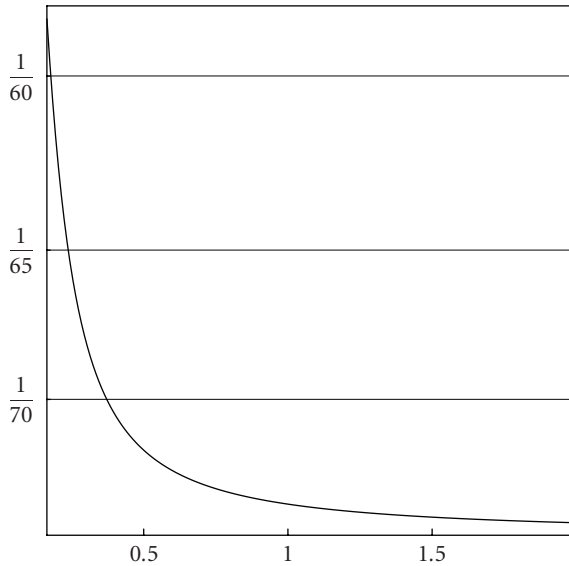

Figure 4.1. The quantity  $p/q = (1/2\pi)\arccos a$ , as a function of  $\beta$ , on the bifurcation curve.

## 5. Bifurcation and Lyapunov exponent diagrams

To illustrate the complicated dynamics involved, we have employed numerical simulations of the trajectories to obtain characteristic bifurcation and Lyapunov exponent diagrams. In Figures 5.1 and 5.2, we present such diagrams for some sample values of the parameter  $\beta$ , with the parameter  $\alpha$  as the bifurcation parameter. Note that due to the horizontal orientation of the bifurcation curve in the  $(\beta, \alpha)$  plane, it is more advantageous to use  $\alpha$  as the bifurcation parameter so as to be able to deduce from the bifurcation diagrams estimates of the amplitudes of the business cycles as these evolve in size after bifurcation. The bifurcation diagrams given here clearly provide such estimates visually and reveal a characteristic feature, namely that while amplitudes of the cycles in  $Y$  and  $M$  increase more or less steadily after bifurcation, the amplitude in  $K$  increases only initially, up to  $\alpha \cong 0.1$ , decreasing subsequently. The bifurcation diagrams also show the existing windows of periodicity. For example, a period-4 window is dominant for the smaller values of  $\beta$  (Figure 5.1), after which period-doubling cascades appear clearly. The Lyapunov exponent diagrams clearly indicate chaotic behavior when it occurs. The bifurcation and Lyapunov exponent diagrams also provide visual estimates of the values of the bifurcation parameter up to which the cycles persist. For example, from the diagrams of Figure 5.1 we can deduce that for  $\beta = 0.2$ , cyclical fluctuations persist roughly up to  $\alpha = 1.5$ . With regard to amplitude estimates, we note as an example that for this value of  $\beta$ , the fluctuations have maximum amplitudes of about 160  $Y$  units, 150  $K$  units, and 35  $M$  units (at different  $\alpha$  values—see also Figure 6.1).

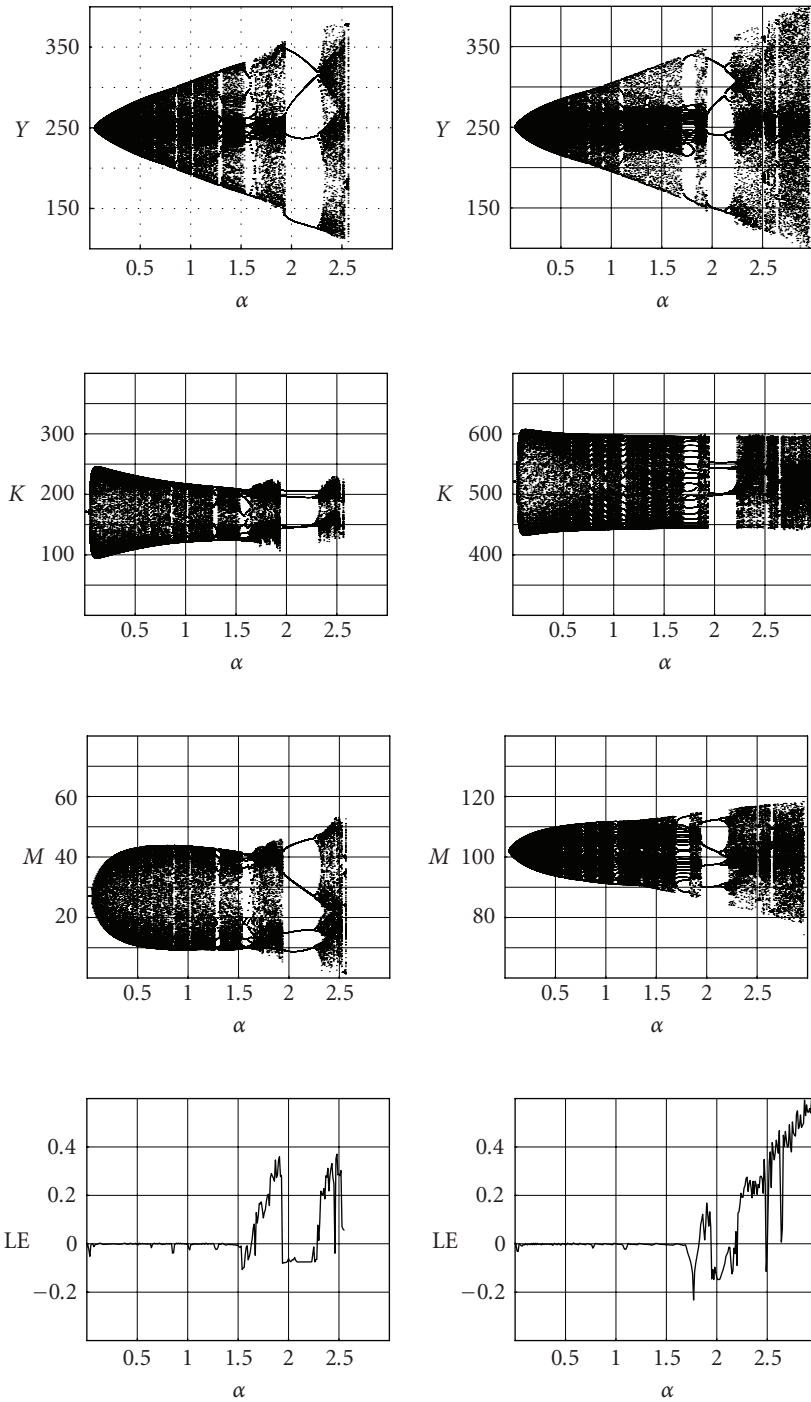

Figure 5.1. Bifurcation diagrams and Lyapunov exponent for  $\beta = 0.2$  (left) and  $\beta = 0.5$  (right).



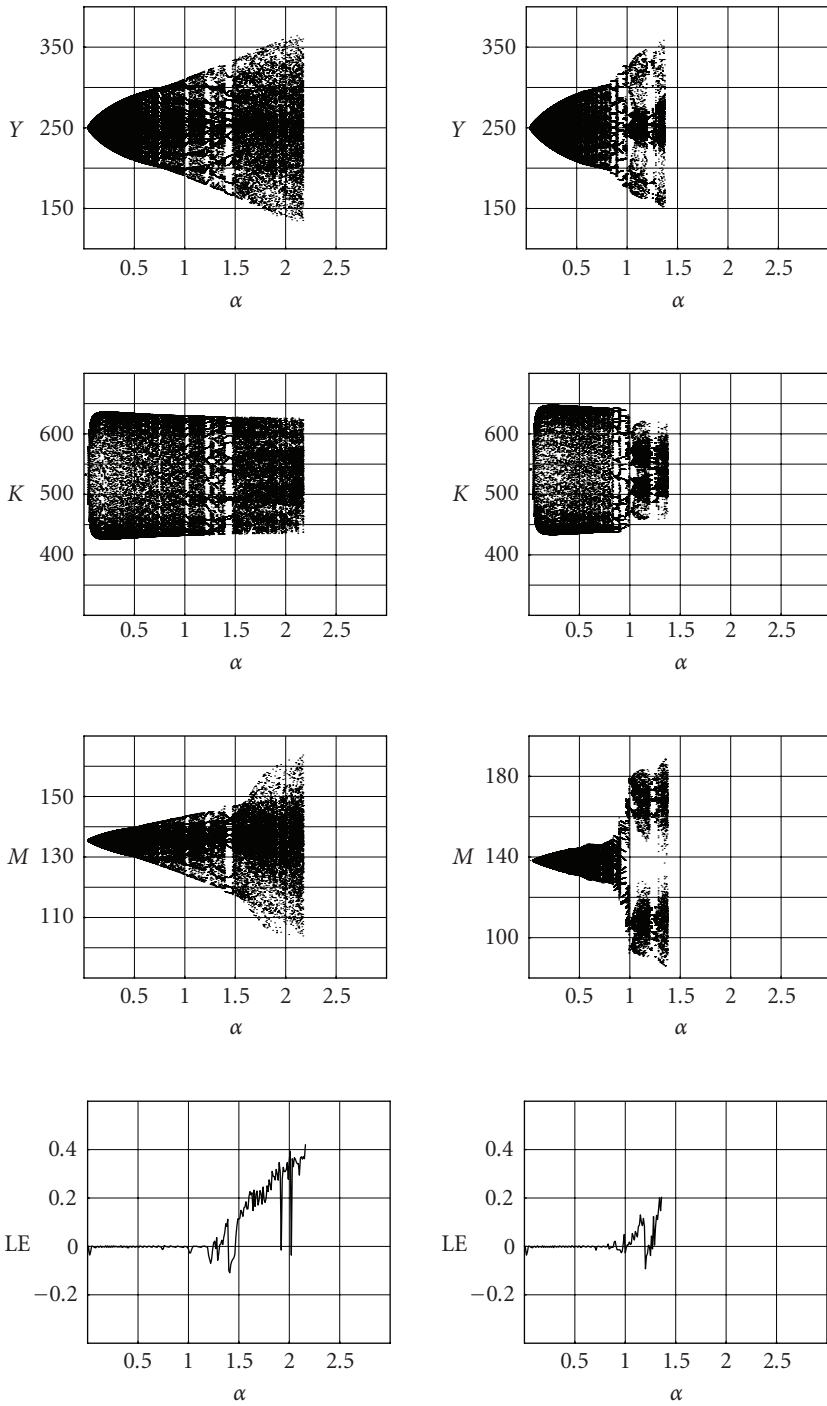

Figure 5.2. Bifurcation diagrams and Lyapunov exponent for  $\beta = 1.5$  (left) and  $\beta = 1.8$  (right).

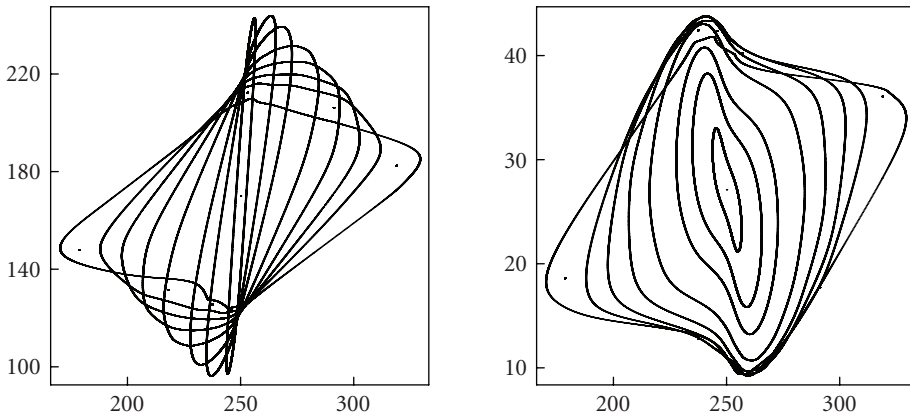

Figure 6.1. Development of cyclical attractors for  $\beta = 0.2$ . Projections in the  $Y$ - $K$  (left) and  $Y$ - $M$  (right) planes.

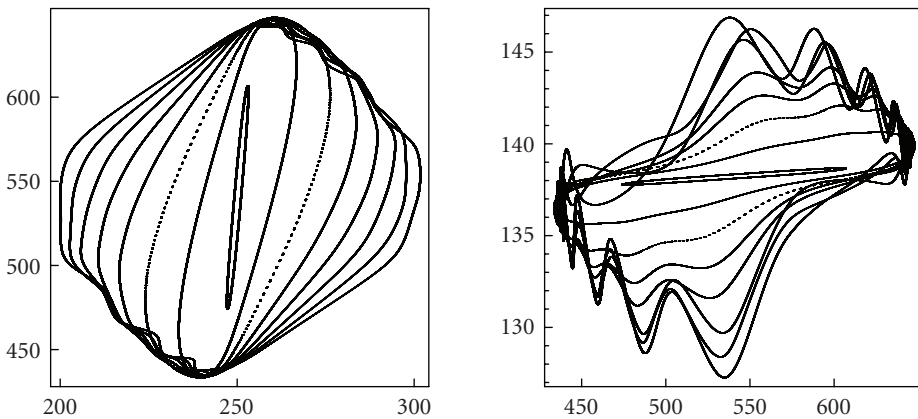

Figure 6.2. Development of cyclical attractors for  $\beta = 1.8$ . Projections in the  $Y$ - $K$  (left) and  $K$ - $M$  (right) planes.

### 6. Examples of cyclical and chaotic attractors

In Figures 6.1 and 6.2, we present examples of cyclical fluctuations as they develop after their generation on the bifurcation curve. As  $\alpha$  increases, the cycles evolve to more irregular shapes. They go through periodicity tongues as indicated by the periodicity windows apparent in the bifurcation diagrams, and in some cases they break up into multipiece attractors (see Figure 6.3). Finally they become chaotic, as betrayed by the positive values of the Lyapunov exponent. Examples are shown in Figure 6.4.

The three possible types of dynamical behavior exhibited by the system are shown in Figure 6.5 in terms of the actual time paths—trajectories—of the capital stock. In the left diagram, we see the case of a stable equilibrium, the system settling at equilibrium after a

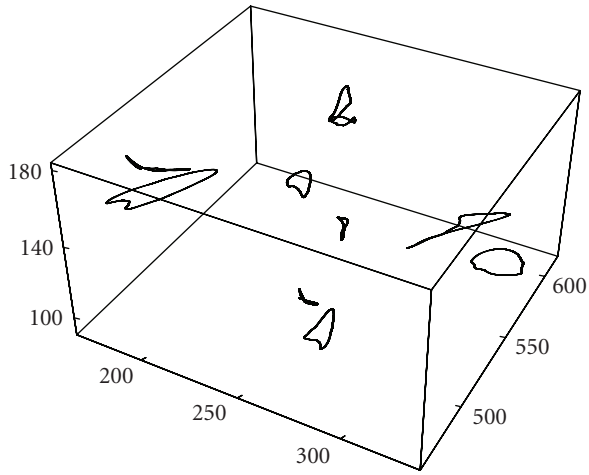

Figure 6.3. Ten-piece attractor for  $\beta = 1.8$ ,  $\alpha = 1.045$ .

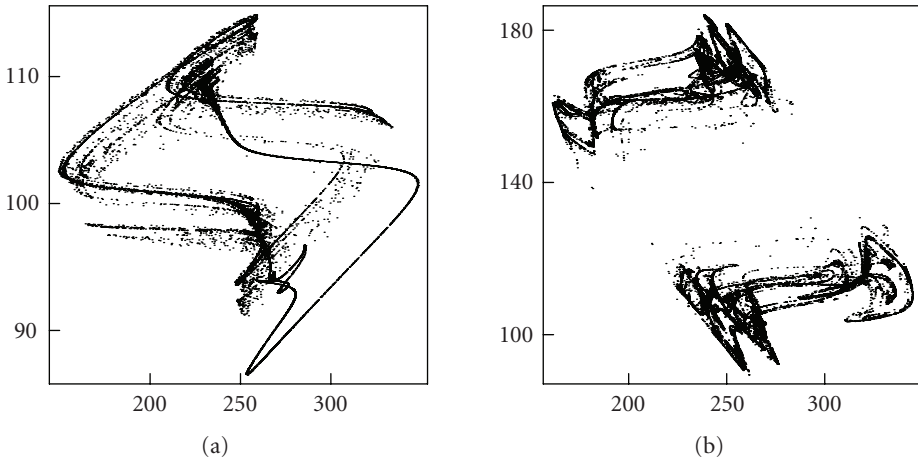

Figure 6.4. (a) Chaotic attractor for  $\beta = 0.5$ ,  $\alpha = 1.9$ ; (b) two-piece chaotic attractor for  $\beta = 1.8$ ,  $\alpha = 1.15$ . Projections in the  $Y-M$  plane.

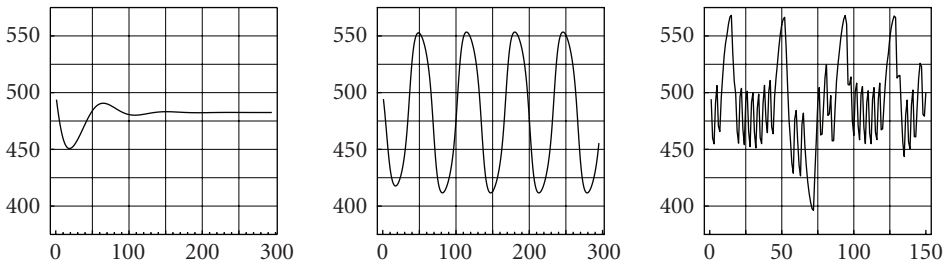

Figure 6.5. Time paths of capital stock  $K$  for  $\beta = 0.8$  and  $\alpha = 0.03, 0.05, 2.6$ .

transient phase. In the middle, we see the case of cyclical fluctuations, and in the right is the case of chaotic behavior appearing as violent alternations “from boom to slump.”

### 7. Model 2: stability of equilibrium and nonexistence of cycles

We now discuss the possible existence of a Hopf-Neimark bifurcation curve in the special two-dimensional variation of the model, called model 2 (see Asada et al. [3]). The system of equations for model 2 is identical to (2.14), (2.15), and (2.16), except that the term  $-0.3K(t)$  is missing from (2.14). This means that the system decouples, with (2.14) and (2.16) becoming independent of  $K$ . For economic-theoretical justification of model 2, see Asada et al. [3] where relevance of this model is discussed as arising from a special case of a type of savings function considered by Chang and Smyth [4], leading to a consumption function representing the “wealth effect” according to which increase of the real capital stock stimulates the consumption expenditure.

Existence of a Hopf-Neimark bifurcation curve would mean that endogenous cyclical fluctuations can be generated in this model. We find, however, that no such curve exists in the parameter space, therefore we may conclude that model 2 does not produce cyclical fluctuations. Let us see how this conclusion is reached. Although model 2 is of lower dimension than model 1, determination of the equilibrium values of the variables in explicit form is more difficult. However, we have derived the following approximate expression giving the equilibrium value of  $Y$  with high accuracy (2 to 3 decimal places correct) in the interval of interest:

$$Y^* = \frac{576.939\beta^2 + 7.79\beta - 8.9}{\beta^2 + 0.33707\beta - 0.0534}. \quad (7.1)$$

With this expression at hand, it is then easy to find expressions for  $K^*$  and  $M^*$  from the equations of the model:

$$K^* = \frac{10}{3} \left[ f(Y^*) + \frac{50}{\beta} + 141 \right] - \frac{Y^*}{\beta}, \quad M^* = 10\sqrt{Y^*} - \frac{3Y^*}{10\beta} + \frac{50}{\beta} - 6. \quad (7.2)$$

Equilibrium is positive for  $\beta > \beta_{\min} \cong 0.260231$ . With all equilibrium values available as expressions of  $\beta$ , we proceed to examine the stability of the equilibrium globally. This is determined by the roots of the characteristic polynomial of the Jacobian matrix of the two-dimensional mapping defined by the equations of model 2 for  $Y$  and  $M$ :

$$\begin{pmatrix} 1 + \frac{\partial F_1}{\partial Y} & \frac{\partial F_1}{\partial M} \\ \frac{\partial F_3}{\partial Y} & 1 + \frac{\partial F_3}{\partial M} \end{pmatrix}, \quad (7.3)$$

evaluated at the equilibrium. The characteristic polynomial is now a quadratic:

$$P_2(\lambda) = \lambda^2 + a_1\lambda + a_0 = 0, \quad (7.4)$$

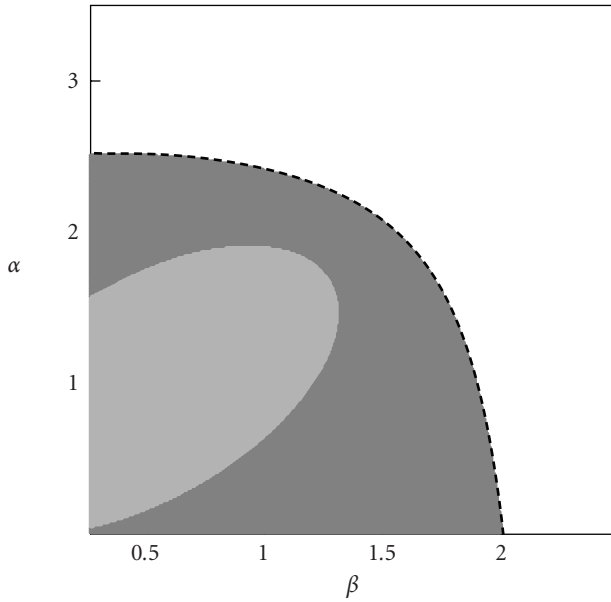

Figure 7.1. Region of stability of the equilibrium of model 2 in the  $(\beta, \alpha)$  parameter plane.

and the conditions for stability are

$$1 + a_0 - |a_1| > 0, \quad a_0 < 1. \quad (7.5)$$

The second condition represents a relation between the parameters  $\beta$  and  $\alpha$  of the model which is satisfied in the entire rectangle containing the shaded part of the region of the  $(\beta, \alpha)$  plane shown in Figure 7.1.

The first condition is satisfied only below the bold-dashed curve of Figure 7.1, this curve is therefore the boundary of the stability region (note that we consider cases of positive equilibrium, therefore the stability diagram is given in this figure for  $\beta > \beta_{\min}$ ). We see that in this case, increase of the speed of adjustment of the goods market  $\alpha$  does not destabilize the equilibrium quickly, as in model 1.

Let us now consider the existence of a Hopf-Neimark bifurcation curve and the generation of business cycles in this model. Using the discriminant  $a_1^2 - 4a_0$  of the quadratic, we find that only within the inner region shown light-shaded are the roots of the characteristic equation complex conjugates. In the remaining part of the stability region, shown dark-dashed, the roots, are real. Therefore, on the boundary of the stability region, stability is lost due to a real root becoming larger than 1 in absolute value. In fact, this real root becomes less than  $-1$  and we have a flip bifurcation. It follows that a Hopf-Neimark bifurcation curve does not exist for model 2 and business cycles are not generated when equilibrium loses stability. Instead, period-doubling cascades appear as the system evolves to chaotic behavior, as can be seen in the examples presented in Figures 7.2 and 7.3.

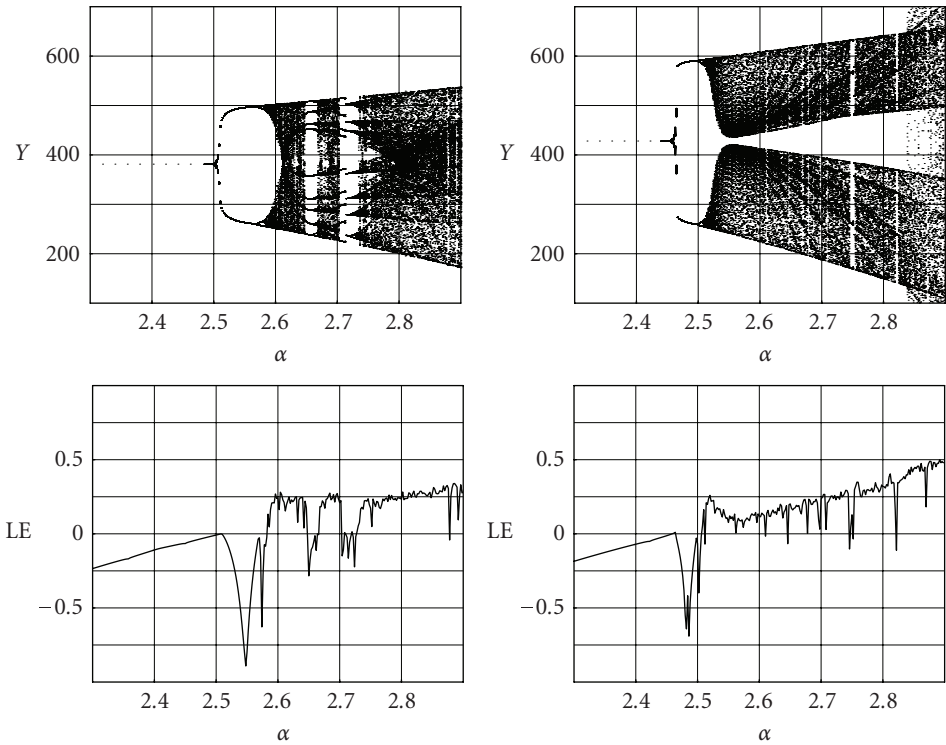

Figure 7.2. Bifurcation diagram of  $Y$  and Lyapunov exponent for model 2,  $\beta = 0.5$  (left) and  $\beta = 0.8$  (right).

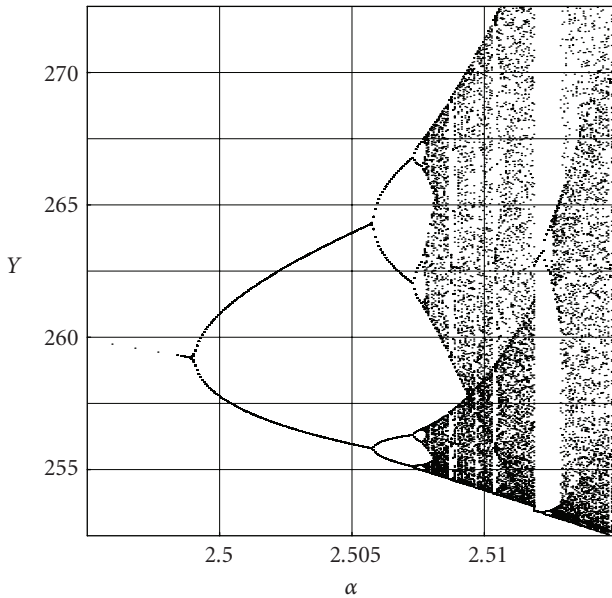

Figure 7.3. Detail of the bifurcation diagram of  $Y$  for model 2,  $\beta = 0.8$ .

## 8. Summary—conclusions

We have explored numerically the occurrence of business cycles in a nonlinear three-dimensional discrete Kaldorian macrodynamic model with fixed exchange rates, considering the effects of variation of the model parameters, the speed of adjustment of the goods market  $\alpha$ , and the degree of capital movement  $\beta$ . The model is sensitive to parameter changes and exhibits complex dynamics. We determined the region of stability of equilibrium and found that increase of the parameter  $\alpha$  destabilizes the system quickly, while increase of  $\beta$  destabilizes the equilibrium less quickly and does not appreciably affect the destabilization process caused by increasing  $\alpha$ . We determined the Hopf-Neimark bifurcation curve in the parameter space, and discussed the possible appearance of Arnold tongues. We computed bifurcation and Lyapunov exponent diagrams as our main tools of investigation providing information on the emergence, amplitude size, and persistence of business cycles. We presented examples of cyclical fluctuations and chaotic behavior of the economic variables.

Finally, we discussed a two-dimensional variation of the model, called model 2, and related to a “wealth effect,” determined the equilibrium and its region of stability, and found that in this case increase of the speed of adjustment of the goods market does not destabilize the equilibrium quickly, as in model 1. We showed that no Hopf-Neimark bifurcation curve exists in the parameter space, therefore model 2 does not produce cyclical fluctuations. Instead, period-doubling cascades appear in this case as the system evolves to chaotic behavior, and we illustrated this by means of relevant bifurcation and Lyapunov exponent diagrams.

## Acknowledgment

During this work, the third author was in receipt of a “K. Karatheodory” Research Grant.

## References

- [1] A. Agliari and R. Dieci, “Coexistence of attractors and homoclinic loops in a Kaldor-like business cycle model,” in *Business Cycle Dynamics. Models and Tools*, pp. 223–254, Springer, Berlin, Germany, 2006.
- [2] T. Asada, “Kaldorian dynamics in an open economy,” *Journal of Economics*, vol. 62, no. 3, pp. 239–269, 1995.
- [3] T. Asada, T. Inaba, and T. Misawa, “A nonlinear macrodynamic model with fixed exchange rates: its dynamics and noise effects,” *Discrete Dynamics in Nature and Society*, vol. 4, no. 4, pp. 319–331, 2000.
- [4] W. W. Chang and D. J. Smyth, “The existence and persistence of cycles in a nonlinear model: Kaldor’s 1940 model re-examined,” *Review of Economic Studies*, vol. 38, no. 1, pp. 37–44, 1971.
- [5] A. Dohntani, T. Misawa, T. Inaba, M. Yokoo, and T. Owase, “Chaos, complex transients and noise: illustration with a Kaldor model,” *Chaos, Solitons & Fractals*, vol. 7, no. 12, pp. 2157–2174, 1996.
- [6] N. Kaldor, “A model of the trade cycle,” *The Economic Journal*, vol. 50, no. 197, pp. 78–92, 1940.
- [7] H.-W. Lorenz, *Nonlinear Dynamical Economics and Chaotic Motion*, Springer, Berlin, Germany, 2nd edition, 1993.

- [8] H.-W. Lorenz, “Analytical and numerical methods in the study of nonlinear dynamical systems in Keynesian economics,” in *Business Cycles: Theory and Empirical Methods*, W. Semmler, Ed., pp. 73–112, Kluwer Academic Publishers, Dordrecht, The Netherlands, 1994.
- [9] G. Gandolfo, *Economic Dynamics*, Springer, Berlin, Germany, 1996.
- [10] T. Puu, *Attractors, Bifurcations, and Chaos*, Springer, Berlin, Germany, 2000.

Toichiro Asada: Faculty of Economics, Chuo University, 742-1 Higashinakano, Hachioji, Tokyo 192-0393, Japan  
*Email address:* asada@tamacc.chuo-u.ac.jp

Christos Douskos: Faculty of Engineering, University of Patras, 26500 Patras, Greece  
*Email address:* c.douskos@des.upatras.gr

Panagiotis Markellos: Faculty of Engineering, University of Patras, 26500 Patras, Greece  
*Email address:* p.markellos@des.upatras.gr