

Algebraic & Geometric Topology

Volume 2 (2002) 337–370

Published: 21 May 2002



On Khovanov's categorification of the Jones polynomial

DROR BAR-NATAN

Abstract The working mathematician fears complicated words but loves pictures and diagrams. We thus give a no-fancy-anything picture rich glimpse into Khovanov's novel construction of "the categorification of the Jones polynomial". For the same low cost we also provide some computations, including one that shows that Khovanov's invariant is strictly stronger than the Jones polynomial and including a table of the values of Khovanov's invariant for all prime knots with up to 11 crossings.

AMS Classification 57M25

Keywords Categorification, Kauffman bracket, Jones polynomial, Khovanov, knot invariants

1 Introduction

In the summer of 2001 the author of this note spent a week at Harvard University visiting David Kazhdan and Dylan Thurston. Our hope for the week was to understand and improve Khovanov's seminal work on the categorification of the Jones polynomial [Kh1, Kh2]. We've hardly achieved the first goal and certainly not the second; but we did convince ourselves that there is something very new and novel in Khovanov's work both on the deep conceptual level (not discussed here) and on the shallower surface level. For on the surface level Khovanov presents invariants of links which contain and generalize the Jones polynomial but whose construction is like nothing ever seen in knot theory before. Not being able to really digest it we decided to just chew some, and then provide our output as a note containing a description of his construction, complete and consistent and accompanied by computer code and examples but stripped of all philosophy and of all the linguistic gymnastics that is necessary for the philosophy but isn't necessary for the mere purpose of having a working construction. Such a note may be more accessible than the original papers. It may lead more people to read Khovanov at the source, and maybe somebody reading such a note will figure out what the Khovanov invariants really are. Congratulations! You are reading this note right now.

1.1 Executive summary In very brief words, Khovanov’s idea is to replace the Kauffman bracket $\langle L \rangle$ of a link projection L by what we call “the Khovanov bracket” $[[L]]$, which is a chain complex of graded vector spaces whose graded Euler characteristic is $\langle L \rangle$. The Kauffman bracket is defined by the axioms

$$\langle \emptyset \rangle = 1; \quad \langle \bigcirc L \rangle = (q + q^{-1})\langle L \rangle; \quad \langle \times \rangle = \langle \succ \rangle - q\langle \oslash \rangle.$$

Likewise, the definition of the Khovanov bracket can be summarized by the axioms

$$[[\emptyset]] = 0 \rightarrow \mathbb{Z} \rightarrow 0; \quad [[\bigcirc L]] = V \otimes [[L]]; \quad [[\times]] = \mathcal{F} \left(0 \rightarrow [[\succ]] \xrightarrow{d} \mathbb{P}\langle \{1\} \rightarrow 0 \right).$$

Here V is a vector space of graded dimension $q + q^{-1}$, the operator $\{1\}$ is the “degree shift by 1” operation, which is the appropriate replacement of “multiplication by q ”, \mathcal{F} is the “flatten” operation which takes a double complex to a single complex by taking direct sums along diagonals, and a key ingredient, the differential d , is yet to be defined.

The (unnormalized) Jones polynomial is a minor renormalization of the Kauffman bracket, $\hat{J}(L) = (-1)^{n_-} q^{n_+ - 2n_-} \langle L \rangle$. The Khovanov invariant $\mathcal{H}(L)$ is the homology of a similar renormalization $[[L]][-n_-]\{n_+ - 2n_-\}$ of the Khovanov bracket. The “main theorem” states that the Khovanov invariant is indeed a link invariant and that its graded Euler characteristic is $\hat{J}(L)$. Anything in $\mathcal{H}(L)$ beyond its Euler characteristic appears to be new, and direct computations show that there really is more in $\mathcal{H}(L)$ than in its Euler characteristic.

1.2 Acknowledgements I wish to thank David Kazhdan and Dylan Thurston for the week at Harvard that led to writing of this note and for their help since then. I also wish to thank G. Bergman, S. Garoufalidis, J. Hoste, V. Jones, M. Khovanov, A. Kricker, G. Kuperberg, A. Stoimenow and M. Thistlethwaite for further assistance, comments and suggestions.

2 The Jones polynomial

All of our links are oriented links in an oriented Euclidean space. We will present links using their projections to the plane as shown in the example on the right. Let L be a link projection, let \mathcal{X} be the set of crossings of L , let $n = |\mathcal{X}|$, let us number the elements of \mathcal{X} from 1 to n in some arbitrary way and let us write $n = n_+ + n_-$ where n_+ (n_-) is the number of right-handed (left-handed) crossings in \mathcal{X} . (again, look to the right).

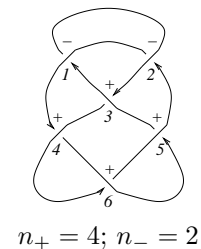

Recall that the Kauffman bracket [Ka] of L is defined by the formulas¹ $\langle \emptyset \rangle = 1$, $\langle \bigcirc L \rangle = (q + q^{-1})\langle L \rangle$ and $\langle \times \rangle = \langle \succ \rangle - q\langle \sphericalangle \rangle$, that the unnormalized Jones polynomial is defined by $\hat{J}(L) = (-1)^{n_-} q^{n_+ - 2n_-} \langle L \rangle$, and that the Jones polynomial of L is simply $J(L) := \hat{J}(L)/(q + q^{-1})$. We name \succ and \sphericalangle the 0- and 1-smoothing of \times , respectively. With this naming convention each vertex $\alpha \in \{0, 1\}^{\mathcal{X}}$ of the n -dimensional cube $\{0, 1\}^{\mathcal{X}}$ corresponds in a natural way to a “complete smoothing” S_α of L where all the crossings are smoothed and the result is just a union of planar cycles. To compute the unnormalized Jones polynomial, we replace each such union S_α of (say) k cycles with a term of the form $(-1)^r q^r (q + q^{-1})^k$, where r is the “height” of a smoothing, the number of 1-smoothings used in it. We then sum all these terms over all $\alpha \in \{0, 1\}^{\mathcal{X}}$ and multiply by the final normalization term, $(-1)^{n_-} q^{n_+ - 2n_-}$. Thus the whole procedure (in the case of the trefoil knot) can be depicted as in the diagram below. Notice that in this diagram we have split the summation over the vertices of $\{0, 1\}^{\mathcal{X}}$ to a summation over vertices of a given height followed by a summation over the possible heights. This allows us to factor out the $(-1)^r$ factor and turn the final summation into an alternating summation:

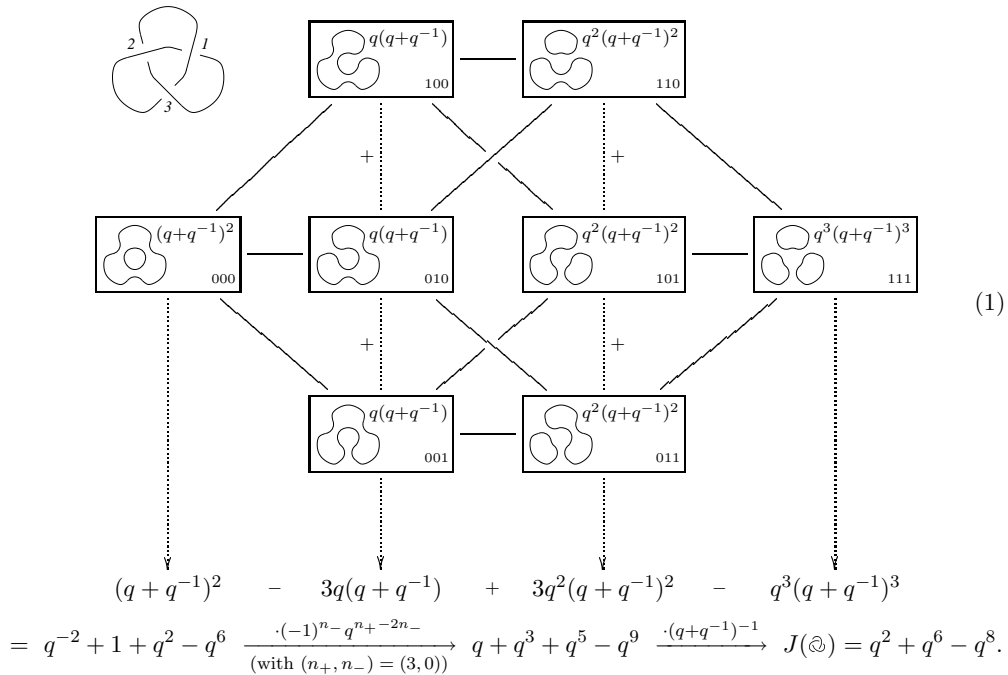

¹Our slightly unorthodox conventions follow [Kh1]. At some minor regrading and renaming cost, we could have used more standard conventions just as well.

3 Categorification

3.1 Spaces

Khovanov’s “categorification” idea is to replace polynomials by graded vector spaces² of the appropriate “graded dimension”, so as to turn the Jones polynomial into a homological object. With the diagram (1) as the starting point the process is straight forward and essentially unique. Let us start with a brief on some necessary generalities:

Definition 3.1 Let $W = \bigoplus_m W_m$ be a graded vector space with homogeneous components $\{W_m\}$. The graded dimension of W is the power series $q\dim W := \sum_m q^m \dim W_m$.

Definition 3.2 Let $\cdot\{l\}$ be the “degree shift” operation on graded vector spaces. That is, if $W = \bigoplus_m W_m$ is a graded vector space, we set $W\{l\}_m := W_{m-l}$, so that $q\dim W\{l\} = q^l q\dim W$.

Definition 3.3 Likewise, let $\cdot[s]$ be the “height shift” operation on chain complexes. That is, if $\bar{\mathcal{C}}$ is a chain complex $\dots \rightarrow \bar{\mathcal{C}}^r \xrightarrow{d^r} \bar{\mathcal{C}}^{r+1} \dots$ of (possibly graded) vector spaces (we call r the “height” of a piece $\bar{\mathcal{C}}^r$ of that complex), and if $\mathcal{C} = \bar{\mathcal{C}}[s]$, then $\mathcal{C}^r = \bar{\mathcal{C}}^{r-s}$ (with all differentials shifted accordingly).

Armed with these three notions, we can proceed with ease. Let L, \mathcal{X}, n and n_{\pm} be as in the previous section. Let V be the graded vector space with two basis elements v_{\pm} whose degrees are ± 1 respectively, so that $q\dim V = q + q^{-1}$. With every vertex $\alpha \in \{0, 1\}^{\mathcal{X}}$ of the cube $\{0, 1\}^{\mathcal{X}}$ we associate the graded vector space $V_{\alpha}(L) := V^{\otimes k}\{r\}$, where k is the number of cycles in the smoothing of L corresponding to α and r is the height $|\alpha| = \sum_i \alpha_i$ of α (so that $q\dim V_{\alpha}(L)$ is the polynomial that appears at the vertex α in the cube at (1)). We then set the r th chain group $[[L]]^r$ (for $0 \leq r \leq n$) to be the direct sum of all the vector spaces at height r : $[[L]]^r := \bigoplus_{\alpha:r=|\alpha|} V_{\alpha}(L)$. Finally (for this long paragraph), we gracefully ignore the fact that $[[L]]$ is not yet a complex, for we have not yet endowed it with a differential, and we set $\mathcal{C}(L) := [[L]][-n_-]\{n_+ - 2n_-\}$. Thus the diagram (1) (in the case of the trefoil knot) becomes:

²Everything that we do works just as well (with some linguistic differences) over \mathbb{Z} . In fact, in [Kh1] Khovanov works over the even more general ground ring $\mathbb{Z}[c]$ where $\deg c = 2$.

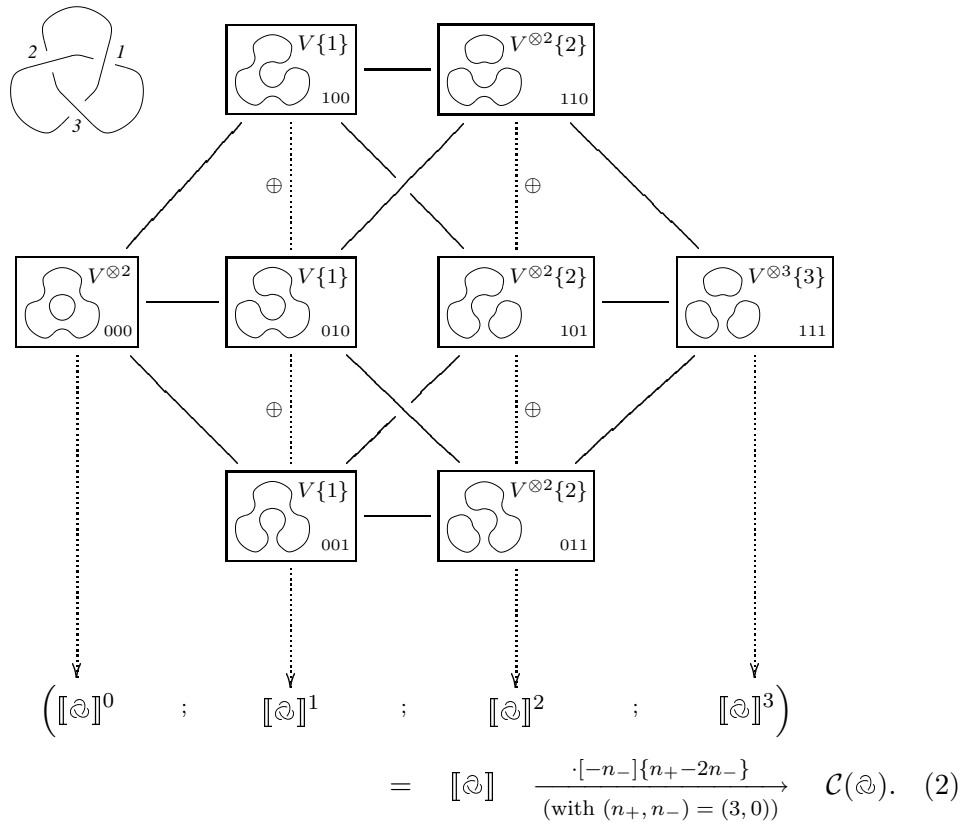

The graded Euler characteristic $\chi_q(\mathcal{C})$ of a chain complex \mathcal{C} is defined to be the alternating sum of the graded dimensions of its homology groups, and, if the degree of the differential d is 0 and all chain groups are finite dimensional, it is also equal to the alternating sum of the graded dimensions of the chain groups. A few paragraphs down we will endow $\mathcal{C}(L)$ with a degree 0 differential. This granted and given that the chains of $\mathcal{C}(L)$ are already defined, we can state and prove the following theorem:

Theorem 1 *The graded Euler characteristic of $\mathcal{C}(L)$ is the unnormalized Jones polynomial of L :*

$$\chi_q(\mathcal{C}(L)) = \hat{J}(L).$$

Proof The theorem is trivial by design; just compare diagrams (1) and (2) and all the relevant definitions. Thus rather than a proof we comment on the statement and the construction preceding it: If one wishes our theorem to hold,

everything in the construction of diagram (2) is forced, except the height shift $[-n_-]$. The parity of this shift is determined by the $(-1)^{n_-}$ factor in the definition of $\hat{J}(L)$. The given choice of magnitude is dictated within the proof of Theorem 2. \square

3.2 Maps

Next, we wish to turn the sequence of spaces $\mathcal{C}(L)$ into a chain complex. Let us flash the answer upfront, and only then go through the traditional ceremony of formal declarations:

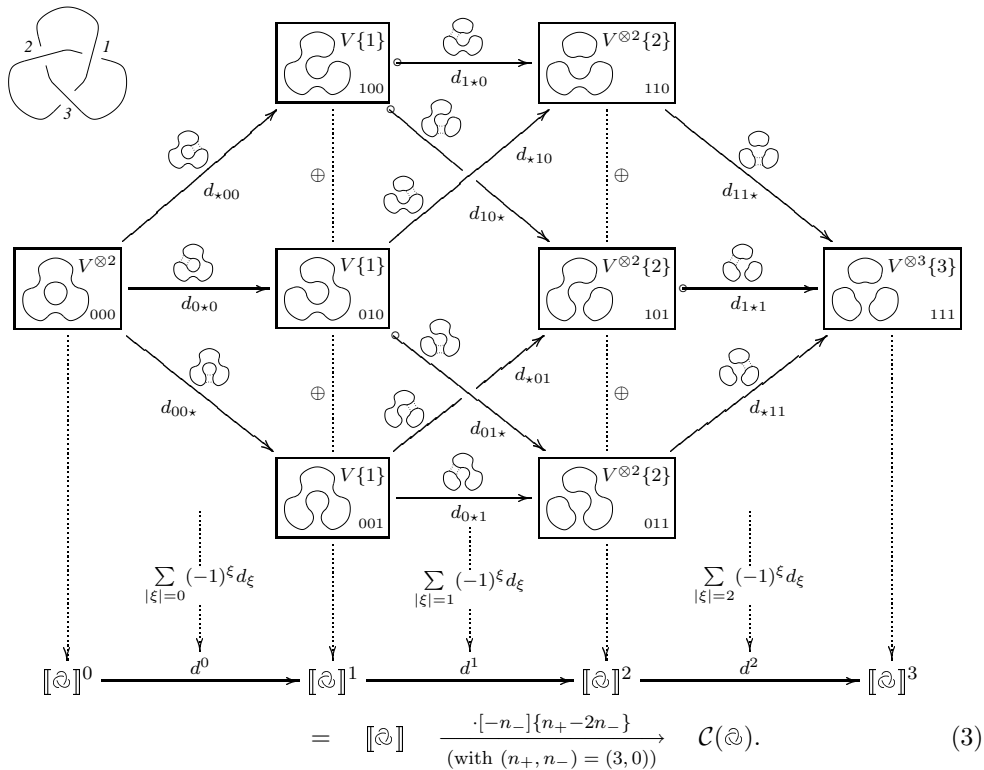

This diagram certainly looks threatening, but in fact, it's quite harmless. Just hold on tight for about a page! The chain groups $[[L]]^r$ are, as we have already seen, direct sums of the vector spaces that appear in the vertices of the cube along the columns above each one of the $[[L]]^r$ spaces. We do the same for the arrows d^r — we turn each edge ξ of the cube to map between the vector spaces at its ends, and then we add up these maps along columns as shown above.

The edges of the cube $\{0, 1\}^{\mathcal{X}}$ can be labeled by sequences in $\{0, 1, \star\}^{\mathcal{X}}$ with just one \star (so the tail of such an edge is found by setting $\star \rightarrow 0$ and the head by setting $\star \rightarrow 1$). The height $|\xi|$ of an edge ξ is defined to be the height of its tail, and hence if the maps on the edges are called d_ξ (as in the diagram), then the vertical collapse of the cube to a complex becomes $d^r := \sum_{|\xi|=r} (-1)^\xi d_\xi$.

It remains to explain the signs $(-1)^\xi$ and to define the per-edge maps d_ξ . The former is easy. To get the differential d to satisfy $d \circ d = 0$, it is enough that all square faces of the cube would anti-commute. But it is easier to arrange the d_ξ 's so that these faces would (positively) commute; so we do that and then sprinkle signs to make the faces anti-commutative. One may verify that this can be done by multiplying d_ξ by $(-1)^\xi := (-1)^{\sum_{i < j} \xi_i}$, where j is the location of the \star in ξ . In diagram (3) we've indicated the edges ξ for which $(-1)^\xi = -1$ with little circles at their tails. The reader is welcome to verify that there is an odd number of such circles around each face of the cube shown.

It remains to find maps d_ξ that make the cube commutative (when taken with no signs) and that are of degree 0 so as not to undermine Theorem 1. The space V_α on each vertex α has as many tensor factors as there are cycles in the smoothing S_α . Thus we put these tensor factors in V_α and cycles in S_α in bijective correspondence once and for all. Now for any edge ξ , the smoothing at the tail of ξ differs from the smoothing at the head of ξ by just a little: either two of the cycles merge into one (see say $\xi = 0\star 0$ above) or one of the cycles splits in two (see say $\xi = 1\star 1$ above). So for any ξ , we set d_ξ to be the identity on the tensor factors corresponding to the cycles that don't participate, and then we complete the definition of ξ using two linear maps $m : V \otimes V \rightarrow V$ and $\Delta : V \rightarrow V \otimes V$ as follows:

$$\left(\begin{array}{c} \circ \circ \xrightarrow{\text{merge}} \circ \\ \circ \circ \xrightarrow{\text{split}} \circ \circ \end{array} \right) \longrightarrow (V \otimes V \xrightarrow{m} V) \quad m : \begin{cases} v_+ \otimes v_- \mapsto v_- & v_+ \otimes v_+ \mapsto v_+ \\ v_- \otimes v_+ \mapsto v_- & v_- \otimes v_- \mapsto 0 \end{cases} \tag{4}$$

$$\left(\begin{array}{c} \circ \circ \xrightarrow{\text{merge}} \circ \\ \circ \circ \xrightarrow{\text{split}} \circ \circ \end{array} \right) \longrightarrow (V \xrightarrow{\Delta} V \otimes V) \quad \Delta : \begin{cases} v_+ \mapsto v_+ \otimes v_- + v_- \otimes v_+ \\ v_- \mapsto v_- \otimes v_- \end{cases} \tag{5}$$

We note that because of the degree shifts in the definition of the V_α 's and because we want the d_ξ 's to be of degree 0, the maps m and Δ must be of degree -1 . Also, as there is no canonical order on the cycles in S_α (and hence on the tensor factors of V_α), m and Δ must be commutative and co-commutative respectively. These requirements force the equality $m(v_+ \otimes v_-) = m(v_- \otimes v_+)$ and force the values of m and Δ to be as shown above up to scalars.

Remark 3.4 It is worthwhile to note, though not strictly necessary to the understanding of this note, that the cube in diagram (3) is related to a certain $(1 + 1)$ -dimensional topological quantum field theory (TQFT). Indeed, given any $(1 + 1)$ -dimensional TQFT one may assign vector spaces to the vertices of $\{0, 1\}^{\mathcal{X}}$ and maps to the edges — on each vertex we have a union of cycles which is a 1-manifold that gets mapped to a vector space via the TQFT, and on each edge we can place the obvious 2-dimensional saddle-like cobordism between the 1-manifolds on its ends, and then get a map between vector spaces using the TQFT. The cube in diagram (3) comes from this construction if one starts from the TQFT corresponding to the Frobenius algebra defined by V, m, Δ , the unit v_+ and the co-unit $\epsilon \in V^*$ defined by $\epsilon(v_+) = 0, \epsilon(v_-) = 1$. See more in [Kh1].

Exercise 3.5 Verify that the definitions given in this section agree with the “executive summary” (Section 1).

3.3 A notational digression

For notational and computational reasons³ it is convenient to also label the edges of L . Our convention is to reserve separate interval of integers for each component, and then to label the edges within this component in an ascending order (except for one jump down) — see Figure 3 in Section 4. Given $\alpha \in \{0, 1\}^{\mathcal{X}}$, we label every cycle in the smoothing S_α by the minimal edge that appears in it, and then we label the tensor factor in V_α accordingly. So for example (with $L = \textcircled{2}$ labeled as in Figure 3), the big and small components of $S_{011} = \textcircled{1} \textcircled{3}$ would be labeled 1 and 3 respectively, and thus V_{011} would be $V_1 \otimes V_3\{2\}$. The indices in the latter space have only a notational meaning that allows us easier access to its tensor factors. Thus $V_1 \otimes V_3 \cong V \otimes V$, yet the standard basis elements of $V_1 \otimes V_3$ have nice standard names: $\{v_+^1 v_+^3, v_+^1 v_-^3, v_-^1 v_+^3, v_-^1 v_-^3\}$.

With this notation, we can make the cube of Equation (3) a little more explicit. We denote by Δ^{ij} the map which acts on a tensor product of labeled copies of V as the identity on all factors except the one labeled $V_{\min(i,j)}$ which gets mapped by Δ of Equation (5) to $V_i \otimes V_j$. Likewise m_{ij} denotes the natural extension by identity maps of $m : V_i \otimes V_j \rightarrow V_{\min(i,j)}$. All said, the cube in diagram (3) becomes:

³You may skip this section if the previous section was clear enough and you don’t intend to read the computational Section 4.

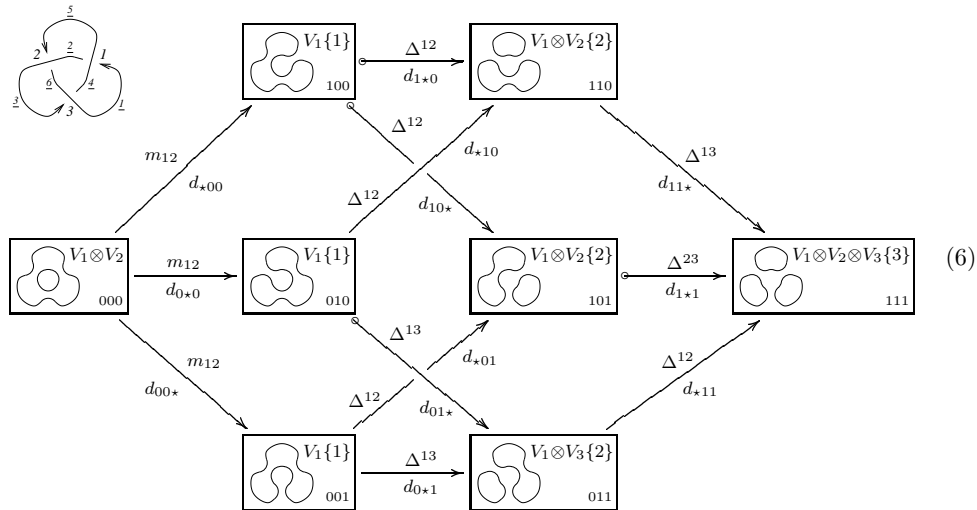

3.4 The main theorem

Claim 3.6 *The n -dimensional cube as in Equation (3) (just as well, (6)) is commutative (for any L , and provided all maps are taken with no signs) and hence the sequences $\llbracket L \rrbracket$ and $\mathcal{C}(L)$ are chain complexes.*

Proof A routine verification. □

Let $\mathcal{H}^r(L)$ denote the r th cohomology of the complex $\mathcal{C}(L)$. It is a graded vector space depending on the link projection L . Let $Kh(L)$ denote the graded Poincaré polynomial of the complex $\mathcal{C}(L)$ in the variable t ; i.e., let

$$Kh(L) := \sum_r t^r q \dim \mathcal{H}^r(L).$$

(When we wish to emphasize the ground field \mathbb{F} , we write $Kh_{\mathbb{F}}(L)$.)

Theorem 2 (Khovanov [Kh1]) *The graded dimensions of the homology groups $\mathcal{H}^r(L)$ are link invariants, and hence $Kh(L)$, a polynomial in the variables t and q , is a link invariant that specializes to the unnormalized Jones polynomial at $t = -1$.*

3.5 Proof of the main theorem

To prove Theorem 2, we need to study the behavior of $\llbracket L \rrbracket$ under the three Reidemeister moves⁴ (R1): $\mathcal{R} \leftrightarrow \mathcal{A}$, (R2): $\mathcal{B} \leftrightarrow \mathcal{C}$ and (R3):

$$\mathcal{D} \leftrightarrow \mathcal{E}.$$

In the case of the Kauffman bracket/Jones polynomial, this is done by reducing the Kauffman bracket of the “complicated side” of each of these moves using the rules $\langle \times \rangle = \langle \smile \rangle - q \langle \frown \rangle$ and $\langle \bigcirc L \rangle = (q + q^{-1}) \langle L \rangle$ and then by canceling terms until the “easy side” is reached. (Example: $\langle \mathcal{R} \rangle = \langle \mathcal{A} \rangle - q \langle \mathcal{B} \rangle = (q + q^{-1}) \langle \mathcal{C} \rangle - q \langle \mathcal{D} \rangle = q^{-1} \langle \mathcal{E} \rangle$). We do nearly the same in the case of the Khovanov bracket. We first need to introduce a “cancellation principle” for chain complexes:

Lemma 3.7 *Let \mathcal{C} be a chain complex and let $\mathcal{C}' \subset \mathcal{C}$ be a sub chain complex.*

- *If \mathcal{C}' is acyclic (has no homology), then it can be “canceled”. That is, in that case the homology $H(\mathcal{C})$ of \mathcal{C} is equal to the homology $H(\mathcal{C}/\mathcal{C}')$ of \mathcal{C}/\mathcal{C}' .*
- *Likewise, if \mathcal{C}/\mathcal{C}' is acyclic then $H(\mathcal{C}) = H(\mathcal{C}')$.*

Proof Both assertions follow easily from the long exact sequence

$$\dots \longrightarrow H^r(\mathcal{C}') \longrightarrow H^r(\mathcal{C}) \longrightarrow H^r(\mathcal{C}/\mathcal{C}') \longrightarrow H^{r+1}(\mathcal{C}') \longrightarrow \dots$$

associated with the short exact sequence $0 \longrightarrow \mathcal{C}' \longrightarrow \mathcal{C} \longrightarrow \mathcal{C}/\mathcal{C}' \longrightarrow 0$. □

3.5.1 Invariance under (R1).

In computing $\mathcal{H}(\mathcal{R})$ we encounter the complex

$$\mathcal{C} = \llbracket \mathcal{R} \rrbracket = \left(\llbracket \mathcal{A} \rrbracket \xrightarrow{m} \llbracket \mathcal{B} \rrbracket \{1\} \right). \tag{7}$$

(Each of the terms in this complex is itself a complex, coming from a whole cube of spaces and maps. We implicitly “flatten” such complexes of complexes to single complexes as in Section 3.2 without further comment). The complex in Equation (7) has a natural subcomplex

$$\mathcal{C}' = \left(\llbracket \mathcal{A} \rrbracket_{v_+} \xrightarrow{m} \llbracket \mathcal{B} \rrbracket \{1\} \right)$$

⁴We leave it to the reader to confirm that no further variants of these moves need to be considered. For example, we check only the “right twist” version of (R1). The left twist version follows from it and from (R2).

We need to pause to explain the notation. Recall that $\llbracket L \rrbracket$ is a direct sum over the smoothings of L of tensor powers of V , with one tensor factor corresponding to each cycle in any given smoothing. Such tensor powers can be viewed as spaces of linear combinations of marked smoothings of L , where each cycle in any smoothing of L is marked by an element of V . For $L = \textcircled{\small \circ}$ all smoothings have one special cycle, the one appearing within the icon $\textcircled{\small \circ}$. The subscript v_+ in $\llbracket \textcircled{\small \circ} \rrbracket_{v_+}$ means “the subspace of $\llbracket \textcircled{\small \circ} \rrbracket$ in which the special cycle is always marked v_+ ”.

It is easy to check that \mathcal{C}' is indeed a subcomplex of \mathcal{C} , and as v_+ is a unit for the product m (see (4)), \mathcal{C}' is acyclic. Thus by Lemma 3.7 we are reduced to studying the quotient complex

$$\mathcal{C}/\mathcal{C}' = \left(\llbracket \textcircled{\small \circ} \rrbracket_{/v_+=0} \rightarrow 0 \right)$$

where the subscript “/ $v_+ = 0$ ” means “mod out (within the tensor factor corresponding to the special cycle) by $v_+ = 0$ ”. But $V/(v_+ = 0)$ is one dimensional and generated by v_- , and hence apart from a shift in degrees, $\llbracket \textcircled{\small \circ} \rrbracket_{/v_+=0}$ is isomorphic to $\llbracket \text{---} \rrbracket$. The reader may verify that this shift precisely gets canceled by the shifts $[-n_-]\{n_+ - 2n_-\}$ in the definition of $\mathcal{C}(L)$ from $\llbracket L \rrbracket$. \square

3.5.2 Invariance under (R2), first proof.

In computing $\mathcal{H}(\text{---})$ we encounter the complex \mathcal{C} of Figure 1. This complex has a subcomplex \mathcal{C}' (see Figure 1), which is clearly acyclic. The quotient complex \mathcal{C}/\mathcal{C}' (see Figure 1) has a subcomplex \mathcal{C}'' (see Figure 1), and the quotient $(\mathcal{C}/\mathcal{C}')/\mathcal{C}''$ (see Figure 1) is acyclic because modulo $v_+ = 0$, the map Δ is an isomorphism. Hence using both parts of Lemma 3.7 we find that $H(\mathcal{C}) = H(\mathcal{C}/\mathcal{C}') = H(\mathcal{C}'')$. But up to shifts in degree and height, \mathcal{C}'' is just $\llbracket \text{---} \rrbracket$. Again, these shifts get canceled by the shifts $[-n_-]\{n_+ - 2n_-\}$ in the definition of $\mathcal{C}(L)$ from $\llbracket L \rrbracket$. \square

3.5.3 Invariance under (R3), unsuccessful attempt.

For the Kauffman bracket, invariance under (R3) follows from invariance under (R2). Indeed, assuming relations of the form $\langle \circ L \rangle = d \langle L \rangle$ and $\langle \times \rangle = A \langle \nearrow \rangle + B \langle \searrow \rangle$ the move (R3) follows from (R2) without imposing any constraints on A , B and d (beyond those that are necessary for (R2) to hold):

$$\langle \text{---} \rangle = A \langle \text{---} \rangle + B \langle \text{---} \rangle \stackrel{(R2)}{=} A \langle \text{---} \rangle + B \langle \text{---} \rangle = \langle \text{---} \rangle$$

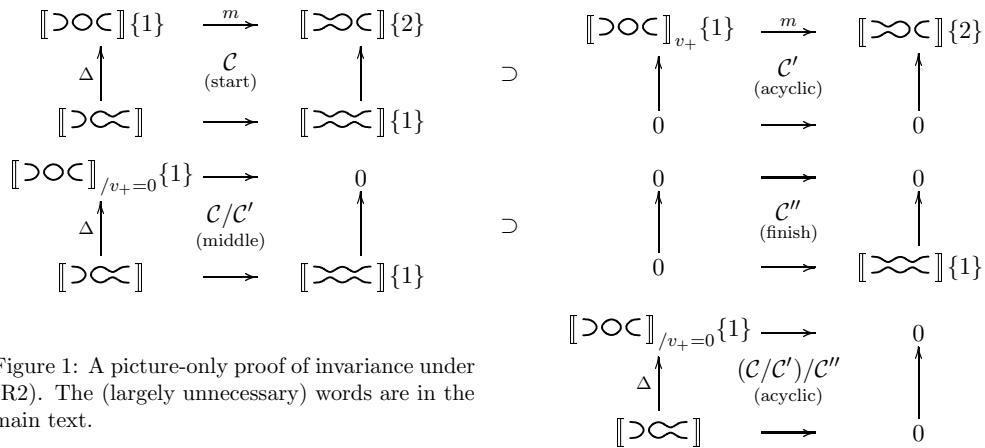
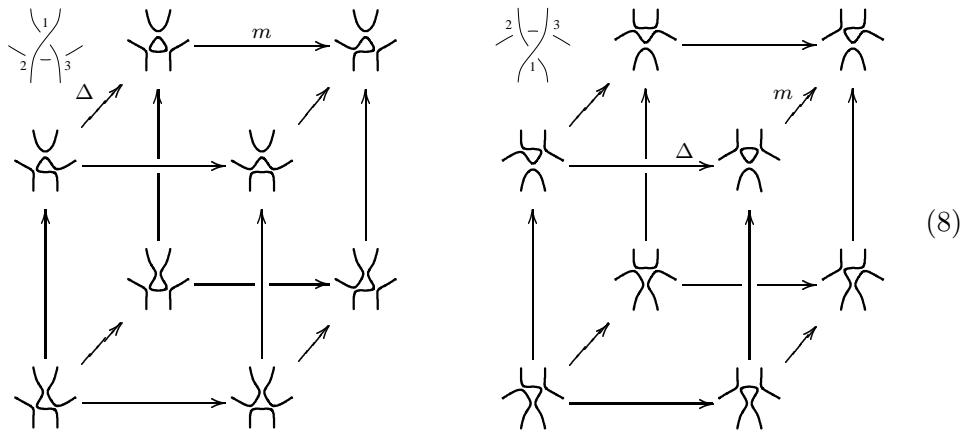

Figure 1: A picture-only proof of invariance under (R2). The (largely unnecessary) words are in the main text.

The case of the Khovanov bracket is unfortunately not as lucky. Invariance under (R2) does play a key role, but more is needed. Let us see how it works.

If we fully smooth the two sides of (R3), we get the following two cubes of complexes (to save space we suppress the Khovanov bracket notation $[[\cdot]]$ and the degree shifts $\{\cdot\}$):



The bottom layers of these two cubes correspond to the partial smoothings and and are therefore isomorphic. The top layers correspond to and and it is tempting to use (R2) on both to reduce to

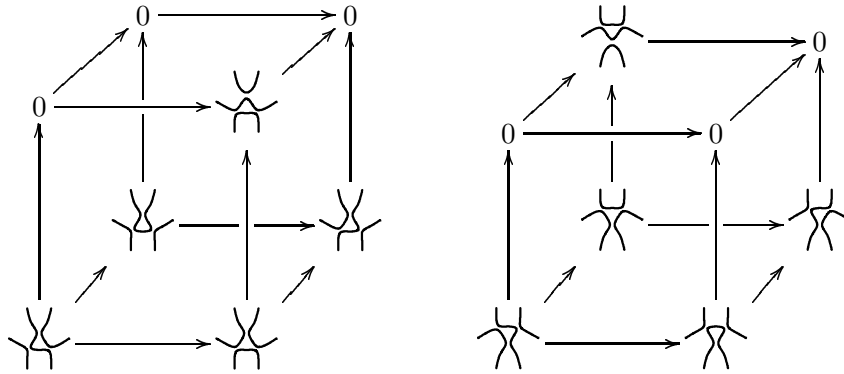

But this fails for two reasons. These cubes aren't isomorphic (their bottom layers are isomorphic and their top layers are isomorphic, but the maps between them are different), and the (R2)-style reduction used to get here is invalid, for in the presence of the bottom layers what would be the analog of \mathcal{C}'' simply isn't a subcomplex. Fortunately, there is a somewhat more complicated proof of invariance under (R2) that does lead to a correct argument for invariance under (R3).

3.5.4 Invariance under (R2), second proof.

We start in the same way as in the first proof and reduce to the complex \mathcal{C}/\mathcal{C}' which is displayed once again in Figure 2 (except this time we suppress the $[\cdot]$ brackets and the degree shift $\{\cdot\}$ symbols). In \mathcal{C}/\mathcal{C}' the vertical arrow Δ is a bijection so we can invert it and compose with the horizontal arrow $d_{\star 0}$ to get a map $\tau : \mathcal{D}\mathcal{O}\mathcal{C}_{/v_+=0} \rightarrow \mathcal{W}$. We now let \mathcal{C}''' be the subcomplex of \mathcal{C}/\mathcal{C}' containing all $\alpha \in \mathcal{D}\mathcal{O}\mathcal{C}_{/v_+=0}$ and all pairs of the form $(\beta, \tau\beta) \in \mathcal{D}\mathcal{O}\mathcal{C}_{/v_+=0} \oplus \mathcal{W}$ (see Figure 2). The map Δ is bijective in \mathcal{C}''' and hence \mathcal{C}''' is acyclic and thus it is enough to study $(\mathcal{C}/\mathcal{C}')/\mathcal{C}'''$.

What is $(\mathcal{C}/\mathcal{C}')/\mathcal{C}'''$? Well, the freedom in the choice of α kills the lower left corner of \mathcal{C}/\mathcal{C}' , and the freedom in the choice of β identifies everything in the upper left corner with some things in the lower right corner (this is the relation $\beta = \tau\beta$ appearing in Figure 2; in more detail it is $(\beta, 0) = (0, \tau\beta)$ in $\mathcal{D}\mathcal{O}\mathcal{C}_{/v_+=0} \oplus \mathcal{W}$). What remains is just the arbitrary choice of γ in the lower right corner and hence the complex $(\mathcal{C}/\mathcal{C}')/\mathcal{C}'''$ is isomorphic to the complex \mathcal{C}'' of Figure 1 and this, as there, is what we wanted to prove. \square

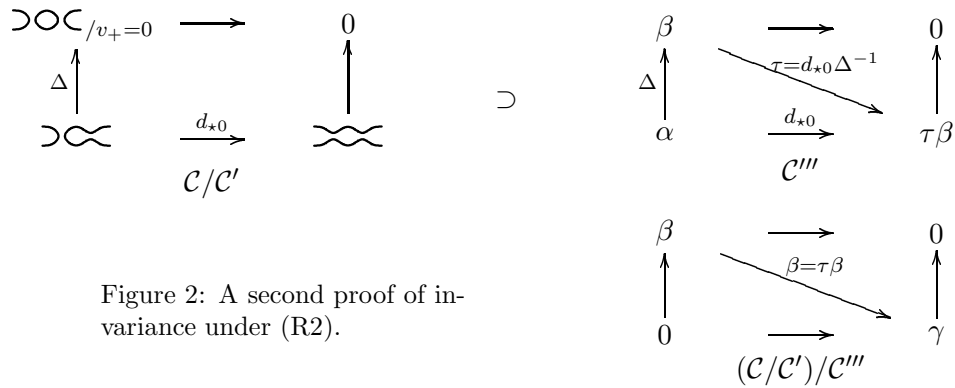
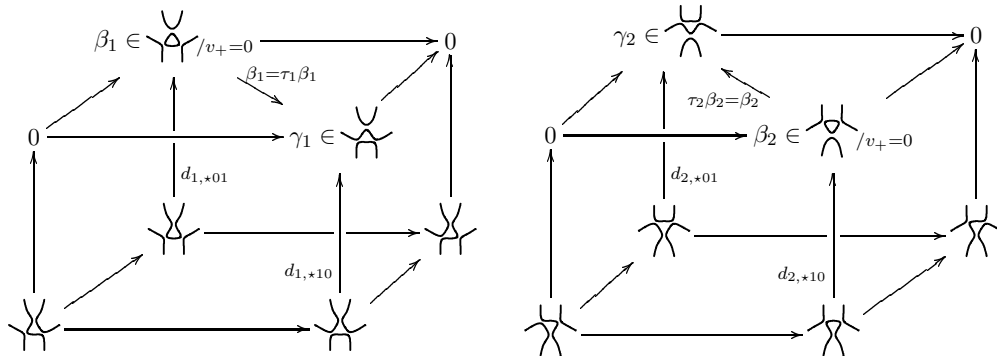

Figure 2: A second proof of invariance under (R2).

3.5.5 Invariance under (R3).

We can now turn back to the proof of invariance under (R3). Repeat the definitions of the acyclic subcomplexes \mathcal{C}' and \mathcal{C}''' as above but within the top layers of each of the cubes in Equation (8), and then mod out each cube by its \mathcal{C}' and \mathcal{C}''' (without changing the homology, by Lemma 3.7). The resulting cubes are



Now these two complexes really are isomorphic, via the map Υ that keeps the bottom layers in place and “transposes” the top layers by mapping the pair (β_1, γ_1) to the pair (β_2, γ_2) . The fact that Υ is an isomorphism on spaces level is obvious. To see that Υ is an isomorphism of complexes we need to know that it commutes with the edge maps, and only the vertical edges require a proof. We leave the (easy) proofs that $\tau_1 \circ d_{1,*01} = d_{2,*01}$ and $d_{1,*10} = \tau_2 \circ d_{2,*10}$ as exercises for our readers. \square

3.6 Some phenomenological conjectures

The following conjectures were formulated in parts by the author and by M. Khovanov and S. Garoufalidis based on computations using the program described in the next section:

Conjecture 1 For any prime knot L there exists an even integer $s = s(L)$ and a polynomial $Kh'(L)$ in $t^{\pm 1}$ and $q^{\pm 1}$ with only non-negative coefficients so that

$$Kh_{\mathbb{Q}}(L) = q^{s-1} (1 + q^2 + (1 + tq^4)Kh'(L)) \tag{9}$$

$$Kh_{\mathbb{F}_2}(L) = q^{s-1}(1 + q^2) (1 + (1 + tq^2)Kh'(L)). \tag{10}$$

(\mathbb{F}_2 denotes the field of two elements.)

Conjecture 2 For prime alternating L the integer $s(L)$ is equal to the signature of L and the polynomial $Kh'(L)$ contains only powers of tq^2 .

We have computed $Kh_{\mathbb{Q}}(L)$ for all prime knots with up to 11 crossings and $Kh_{\mathbb{F}_2}(L)$ for all knots with up to 7 crossings and the results are in complete agreement with these two conjectures⁵.

We note that these conjectures imply that for alternating knots Kh' (and hence $Kh_{\mathbb{Q}}$ and $Kh_{\mathbb{F}_2}$) are determined by the Jones polynomial. As we shall see in the next section, this is not true for non-alternating knots.

As a graphical illustration of Conjectures 1 and 2 the table on the right contains the dimensions of the homology groups $\mathcal{H}_m^r(10_{100})$ (the coefficients of $t^r q^m$ in the invariant $Kh(10_{100})$) for all r and m in the relevant range. Conjecture 1 is the fact that if we subtract 1 from two of the entries in the column $r =$

$m \backslash r$	-7	-6	-5	-4	-3	-2	-1	0	1	2	3
3											1
1										2	
-1									3	1	
-3								(4+1)	2		
-5							5	(3+1)			
-7						6	4				
-9					4	5					
-11				4	6						
-13			2	4							
-15		1	4								
-17		2									
-19	1										

0 (a ‘‘pawn move’’), the remaining entries are arranged in ‘‘knight move’’ pairs

⁵Except that for 11 crossing prime alternating knots only the absolute values of σ and s were compared.

$m \backslash r$	-7	-6	-5	-4	-3	-2	-1	0	1	2	3
3											1/1
1								0/1	0/5	2/10	0/4
-1					0/2	0/13	0/36	0/59	3/60	1/30	0/6
-3	0/1	0/10	0/45	0/120	0/220	0/304	0/318	5/237	2/110	0/30	0/4
-5	0/8	0/70	0/270	0/600	0/862	0/847	5/564	4/237	0/60	0/10	0/1
-7	0/28	0/210	0/675	0/1200	0/1288	6/847	4/318	0/59	0/5		
-9	0/56	0/350	0/900	0/1200	4/862	5/304	0/36	0/1			
-11	0/70	0/350	0/675	4/600	6/220	0/13					
-13	0/56	0/210	2/270	4/120	0/2						
-15	0/28	1/70	4/45								
-17	0/8	2/10									
-19	1/1										

Table 1: $\dim \mathcal{H}_m^r(10_{100}) / \dim \mathcal{C}_m^r(10_{100})$ for all values of r and m for which $\mathcal{C}_m^r(10_{100}) \neq \emptyset$.

of the form

	a
a	

 with $a > 0$. Conjecture 2 is the fact that furthermore all nontrivial entries in the table occur on just two diagonals that cross the column $r = 0$ at $m = \sigma \pm 1$ where $\sigma = -4$ is the signature of 10_{100} . Thus after the fix at the $r = 0$ column, the two nontrivial diagonals are just shifts of each other and are thus determined by a single list of entries (1 2 4 4 6 5 4 3 2 1, in our case). This list of entries is the list of coefficients of $Kh'(10_{100}) = u^{-7} + 2u^{-6} + 4u^{-5} + 4u^{-4} + 6u^{-3} + 5u^{-2} + 4u^{-1} + 3 + 2u + u^2$ (with $u = tq^4$).

As an aside we note that typically $\dim \mathcal{H}_m^r(L)$ is much smaller than $\dim \mathcal{C}_m^r(L)$, as illustrated in Table 1. We don't know why this is so.

A further phenomenological conjecture is presented in [Ga]. This paper's web page [1] will follow further phenomenological developments as they will be announced.

4 And now in computer talk

In computer talk (Mathematica [Wo] dialect) we represent every link projection by a list of edges numbered $1, \dots, n$ with increasing numbers as we go around each component and by a list crossings presented as symbols X_{ijkl} where i, \dots, l are the edges around that crossing, starting from the incoming lower thread and proceeding counterclockwise (see Figure 3).

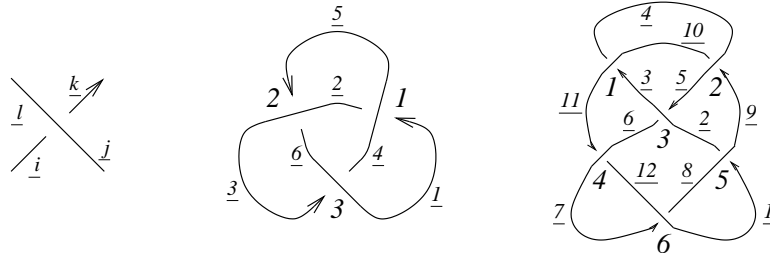

Figure 3: The crossing X_{ijkl} , the right handed trefoil knot $X_{1524}X_{5362}X_{3146}$ and the Miller Institute knot (aka 6_2) $X_{3,10,4,11}X_{9,4,10,5}X_{5,3,6,2}X_{11,7,12,6}X_{1,9,2,8}X_{7,1,8,12}$ (we've used a smaller font and underlining to separate the edge labeling from the vertex labeling).

4.1 A demo run

We first start up Mathematica [Wo] and load our categorification package, `Categorification` (available from [1]):

```
Mathematica 4.1 for Linux
Copyright 1988-2000 Wolfram Research, Inc.
-- Motif graphics initialized --
```

```
In[1]:= << Categorification
```

```
Loading Categorification...
```

Next, we type in the trefoil knot:

```
In[2]:= L = Link[X[1,5,2,4], X[5,3,6,2], X[3,1,4,6]];
```

Let us now view the edge $0\star 1$ of the cube of smoothings of the trefoil knot (as seen in Section 3.3, this edge begins with a single cycle labeled 1 and ends with two cycles labeled 1 and 3):

```
In[3]:= {S[L, "001"], S[L, "0*1"], S[L, "011"]}
```

```
Out[3]= {c[1], c[1] -> c[1]*c[3], c[1]*c[3]}
```

Next, here's a basis of the space V_{011} (again, compare with Section 3.3):

```
In[4]:= v[L, "011"]
```

```
Out[4]= {vm[1]*vm[3], vm[3]*vp[1], vm[1]*vp[3], vp[1]*vp[3]}
```

And here's a basis of the degree 2 elements of V_{111} (remember the shift in degrees in the definition of V_α !):

```
In[5]:= v[L, "111", 2]
```

```
Out[5]= {vm[2]*vm[3]*vp[1], vm[1]*vm[3]*vp[2], vm[1]*vm[2]*vp[3]}
```

The per-edge map d_ξ is a list of simple replacement rules, sometimes replacing the tensor product of two basis vectors by a single basis vector, as in the case of $d_{00\star} = m_{12}$, and sometimes the opposite, as in the case of $d_{0\star 1} = \Delta^{13}$:

```
In[6]:= d[L, "00*"]
```

```
Out[6]= {vp[1]*vp[2] -> vp[1], vm[2]*vp[1] -> vm[1], vm[1]*vp[2] -> vm[1],
  vm[1]*vm[2] -> 0}
```

```
In[7]:= d[L, "0*1"]
```

```
Out[7]= {vp[1] -> vm[3]*vp[1] + vm[1]*vp[3], vm[1] -> vm[1]*vm[3]}
```

Here's a simple example. Let us compute $d_{1\star 1}$ applied to V_{101} :

```
In[8]:= v[L, "101"] /. d[L, "1*1"]
```

```
Out[8]= {vm[1]*vm[2]*vm[3], vm[2]*vm[3]*vp[1],
  vm[1]*(vm[3]*vp[2] + vm[2]*vp[3]), vp[1]*(vm[3]*vp[2] + vm[2]*vp[3])}
```

And now a more complicated example. First, we compute the degree 0 part of $[[\otimes]]^1$. Then we apply d^1 to it, and then d^2 to the result. The end result better be a list of zeros, or else we are in trouble! Notice that each basis vector in $[[\otimes]]^{1,2}$ is tagged with a symbol of the form $v[\dots]$ that indicates the component of $[[\otimes]]^{1,2}$ to which it belongs.

```
In[9]:= chains = KhBracket[L, 1, 0]
```

```
Out[9]= {v[0, 0, 1]*vm[1], v[0, 1, 0]*vm[1], v[1, 0, 0]*vm[1]}
```

In[10]:= boundaries = d[L][chains]

Out[10]= {v[1, 0, 1]*vm[1]*vm[2] + v[0, 1, 1]*vm[1]*vm[3],
 v[1, 1, 0]*vm[1]*vm[2] - v[0, 1, 1]*vm[1]*vm[3],
 -(v[1, 0, 1]*vm[1]*vm[2]) - v[1, 1, 0]*vm[1]*vm[2]}

In[11]:= d[L][boundaries]

Out[11]= {0, 0, 0}

Because of degree shifts, the degree 3 part of $\mathcal{C}^1(\mathcal{O})$ is equal to the degree 0 part of $[\mathcal{O}]^1$:

In[12]:= CC[L, 1, 3] == KhBracket[L, 1, 0]

Out[12]= True

It seems that $\mathcal{H}^2(\mathcal{O})$ is one dimensional, and that the non trivial class in $\mathcal{H}^2(\mathcal{O})$ lies in degree 5 (our program defaults to computations over the rational numbers if no other modulus is specified):

In[13]:= qBetti[L, 2]

Out[13]= q⁵

Here's Khovanov's invariant of the right handed trefoil along if its evaluation at $t = -1$, the unnormalized Jones polynomial $\hat{J}(\mathcal{O})$:

In[14]:= kh1 = Kh[L]

Out[14]= q + q³ + q⁵*t² + q⁹*t³

In[15]:= kh1 /. t -> -1

Out[15]= q + q³ + q⁵ - q⁹

We can also compute $Kh_{\mathbb{F}_2}(\mathcal{O})$ and use it to compute $\hat{J}(\mathcal{O})$ again (we leave it to the reader to verify Conjecture 1 in the case of $L = \mathcal{O}$):

In[16]:= kh2 = Kh[L, Modulus -> 2]

Out[16]= $q + q^3 + q^5 t^2 + q^7 t^2 + q^7 t^3 + q^9 t^3$

In[17]:= `kh2 /. t -> -1`

Out[17]= $q + q^3 + q^5 - q^9$

The package `Links` (available from [1]) contains the definitions of many interesting knot and link projections including Millett's 10 crossing hard-to-simplify unknot (shown on the right) and the knots 5_1 and 10_{132} (knot numbering as in Rolfsen's [Ro]):

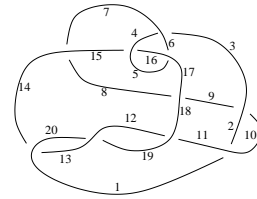

In[18]:= `<< Links`

`Loading Links...`

In[19]:= `MillettUnknot`

Out[19]= `Link[X[1, 10, 2, 11], X[9, 2, 10, 3], X[3, 7, 4, 6], X[15, 5, 16, 4],
X[5, 17, 6, 16], X[7, 14, 8, 15], X[8, 18, 9, 17],
X[11, 18, 12, 19], X[19, 12, 20, 13], X[13, 20, 14, 1]]`

In[20]:= `Kh[MillettUnknot]`

Out[20]= $q^{-1} + q$

In[21]:= `kh3 = Kh[Knot[5, 1]]`

Out[21]= $q^{-5} + q^{-3} + 1/(q^{15} t^5) + 1/(q^{11} t^4) + 1/(q^{11} t^3) + 1/(q^7 t^2)$

In[22]:= `kh4 = Kh[Knot[10, 132]]`

Out[22]= $q^{-3} + q^{-1} + 1/(q^{15} t^7) + 1/(q^{11} t^6) + 1/(q^{11} t^5) + 1/(q^9 t^4) + 1/(q^7 t^4) + 1/(q^9 t^3) + 1/(q^5 t^3) + 2/(q^5 t^2) + 1/(q t)$

In[23]:= `(kh3 /. t -> -1) == (kh4 /. t -> -1)`

Out[23]= `True`

These are excellent news! We have just learned that our program is not confused by complicated mess, and even better, we have just learned that Khovanov's invariant is strictly stronger than the Jones polynomial, for $J(5_1) = J(10_{132})$ whereas $Kh(5_1) \neq Kh(10_{132})$.

Here are two further pieces of good news:

```
In[24]:= diff1 = Together[Kh[Knot[9, 42]] - Kh[Mirror[Knot[9, 42]]]]
```

```
Out[24]= (1 + q^4*t - t^2 + q^4*t^2 - q^4*t^3 + q^6*t^3 + q^8*t^3 - q^4*t^4 +
  q^10*t^4 - q^6*t^5 - q^8*t^5 + q^10*t^5 - q^10*t^6 + q^14*t^6 -
  q^10*t^7 - q^14*t^8)/(q^7*t^4)
```

```
In[25]:= diff2 = Expand[q^9*t^5*(Kh[Knot[10, 125]]-Kh[Mirror[Knot[10, 125]]])]

```

```
Out[25]= 1 + q^4*t - t^2 + q^4*t^2 - q^4*t^3 + q^6*t^3 + q^8*t^3 - q^4*t^4 +
  q^10*t^4 - q^6*t^5 - 2*q^8*t^5 + 2*q^10*t^5 + q^12*t^5 - q^8*t^6 +
  q^14*t^6 - q^10*t^7 - q^12*t^7 + q^14*t^7 - q^14*t^8 + q^18*t^8 -
  q^14*t^9 - q^18*t^10
```

```
In[26]:= {diff1, diff2} /. t -> -1
```

```
Out[26]= {0, 0}
```

Thus we see that Kh detects the facts that $9_{42} \neq \overline{9_{42}}$ and $10_{125} \neq \overline{10_{125}}$ whereas the Jones polynomial doesn't detect that. See also Section 4.5.

4.2 The program

The program `Categorification.m` and the data files `Data.m` and `Links.m` demonstrated in this article are available at

<http://www.maths.warwick.ac.uk/agt/ftp/aux/agt-2-16/>

(with a link from the home page of this paper) and also from the arXiv at [1]. A complete listing of the package `Categorification.m` takes up less than 70 lines of code, demonstrating that categorification must be quite simple.

4.3 $Kh'(L)$ for prime knots with up to 10 crossings

Conjecture 1 on page 351 introduces an integer $s = s(L)$ and a polynomial $Kh'(L)$. By direct computation using our program we verified that these quantities are determined by $Kh_{\mathbb{Q}}(L)$ for all knots with up to 11 crossings. These quantities easily determine $Kh_{\mathbb{Q}}(L)$ (and also $Kh_{\mathbb{F}_2}(L)$, at least up to knots with 7 crossings), as in the statement of Conjecture 1.

There are many fewer terms in $Kh'(L)$ as there are in $Kh_{\mathbb{Q}}(L)$ or in $Kh_{\mathbb{F}_2}(L)$ and thus with the rain forests in our minds, we've tabulated s and $Kh'(L)$ rather than $Kh_{\mathbb{Q}}(L)$ and/or $Kh_{\mathbb{F}_2}(L)$. To save further space, we've underlined negative numbers ($\underline{1} := -1$), used the notation a_m^r to denote the monomial $at^r q^m$ and suppressed all “+” signs. Thus $Kh'(7_7) = \frac{1}{q^6 t^3} + \frac{2}{q^4 t^2} + \frac{1}{q^2 t} + 2 + 2q^2 t + q^4 t^2 + q^6 t^3$ is printed as $1_{\underline{6}2_{\underline{4}}^2 1_{\underline{2}}^2 2_0^0 2_2^1 1_4^2 1_6^3$.

Staring at the tables below it is difficult not to notice that $s(L)$ is often equal to the signature $\sigma = \sigma(L)$ of L , and that most monomials in most $Kh'(L)$'s are of the form $t^r q^{2r}$ for some r . We've marked the exceptions to the first observation by the flag \clubsuit and the knots where exceptions to the second observation occur by the flag \spadesuit . All exceptions occur at non-alternating knots. (And for your convenience, these are marked by the flag \diamond).



























Acknowledgement and Warning. The combinatorial data on which I based the computations was provided to me by A. Stoimenow (see [St]), who himself borrowed it from J. Hoste and M. Thistlethwaite [HT], and was translated to our format by a program written by D. Thurston. The knot pictures below were generated using R. Scharein's program KnotPlot [Sc]. The assembly of all this information involved some further programming and manual work. I hope that no errors crept through, but until everything is independently verified, I cannot be sure of that. I feel that perhaps other than orientation issues (some knots may have been swapped with the mirrors) the data below is reliable. Finally, note that we number knots as in Rolfsen's [Ro], except that we have removed 10_{162} which is equal to 10_{161} (this is the famed “Perko pair”). Hence Rolfsen's $10_{163, \dots, 166}$ are ours $10_{162, \dots, 165}$.

All data shown here is available in computer readable format at [1, the file `Data.m`].

L	$n_k;$ $Kh'(L)$	$\sigma;$	$s;$	flags	L	$n_k;$ $Kh'(L)$	$\sigma;$	$s;$	flags
	$3_1;$ $1_{\underline{6}}$	$\underline{2};$	$\underline{2}$						
	$4_1;$ $1_{\underline{4}}1_{\underline{2}}$	$0;$	0						
	$5_1;$ $1_{\underline{10}}1_{\underline{6}}$	$\underline{4};$	$\underline{4}$			$5_2;$ $1_{\underline{10}}1_{\underline{6}}1_{\underline{4}}$	$\underline{2};$	$\underline{2}$	
	$6_1;$ $1_{\underline{8}}1_{\underline{4}}1_{\underline{2}}1_{\underline{2}}$	$0;$	0			$6_2;$ $1_{\underline{8}}1_{\underline{6}}1_{\underline{4}}1_{\underline{2}}1_{\underline{2}}$	$\underline{2};$	$\underline{2}$	
	$6_3;$ $1_{\underline{6}}1_{\underline{4}}1_{\underline{2}}1_0^01_{\underline{2}}1_{\underline{4}}^2$	$0;$	0						
	$7_1;$ $1_{\underline{14}}1_{\underline{10}}1_{\underline{6}}$	$\underline{6};$	$\underline{6}$			$7_2;$ $1_{\underline{14}}1_{\underline{10}}1_{\underline{8}}1_{\underline{6}}1_{\underline{4}}$	$\underline{2};$	$\underline{2}$	
	$7_3;$ $1_{\underline{2}}1_{\underline{4}}1_{\underline{6}}^32_{\underline{8}}^41_{\underline{12}}^6$	$4;$	4			$7_4;$ $2_{\underline{2}}^11_{\underline{4}}^32_{\underline{8}}^41_{\underline{12}}^6$	$2;$	2	
	$7_5;$ $1_{\underline{14}}^71_{\underline{12}}^62_{\underline{10}}^51_{\underline{8}}^42_{\underline{6}}^31_{\underline{4}}^2$	$\underline{4};$	$\underline{4}$			$7_6;$ $1_{\underline{10}}^51_{\underline{8}}^42_{\underline{6}}^32_{\underline{4}}^21_{\underline{2}}^101_{\underline{2}}^1$	$\underline{2};$	$\underline{2}$	
	$7_7;$ $1_{\underline{6}}^32_{\underline{4}}^21_{\underline{2}}^12_0^02_{\underline{2}}^11_{\underline{4}}^21_{\underline{6}}^3$	$0;$	0						
	$8_1;$ $1_{\underline{12}}^61_{\underline{8}}^41_{\underline{6}}^31_{\underline{4}}^21_{\underline{2}}^11_{\underline{2}}^1$	$0;$	0			$8_2;$ $1_{\underline{12}}^61_{\underline{10}}^51_{\underline{8}}^42_{\underline{6}}^31_{\underline{4}}^21_{\underline{2}}^11_{\underline{2}}^1$	$\underline{4};$	$\underline{4}$	
	$8_3;$ $1_{\underline{8}}^42_{\underline{4}}^21_{\underline{2}}^11_0^02_{\underline{2}}^11_{\underline{6}}^3$	$0;$	0			$8_4;$ $1_{\underline{8}}^41_{\underline{6}}^32_{\underline{4}}^21_{\underline{2}}^11_0^02_{\underline{2}}^11_{\underline{6}}^3$	$\underline{2};$	$\underline{2}$	
	$8_5;$ $1_{\underline{4}}^22_0^01_{\underline{2}}^12_{\underline{4}}^22_{\underline{6}}^31_{\underline{8}}^41_{\underline{10}}^5$	$4;$	4			$8_6;$ $1_{\underline{12}}^61_{\underline{10}}^52_{\underline{8}}^42_{\underline{6}}^32_{\underline{4}}^21_{\underline{2}}^11_{\underline{2}}^1$	$\underline{2};$	$\underline{2}$	
	$8_7;$ $1_{\underline{6}}^31_{\underline{4}}^21_{\underline{2}}^12_0^02_{\underline{2}}^12_{\underline{4}}^21_{\underline{6}}^31_{\underline{8}}^4$	$2;$	2			$8_8;$ $1_{\underline{6}}^31_{\underline{4}}^21_{\underline{2}}^12_0^02_{\underline{2}}^12_{\underline{4}}^21_{\underline{6}}^31_{\underline{8}}^4$	$0;$	0	
	$8_9;$ $1_{\underline{8}}^41_{\underline{6}}^32_{\underline{4}}^22_0^02_{\underline{2}}^11_{\underline{4}}^21_{\underline{6}}^3$	$0;$	0			$8_{10};$ $1_{\underline{6}}^31_{\underline{4}}^22_{\underline{2}}^12_0^02_{\underline{2}}^13_{\underline{4}}^21_{\underline{6}}^31_{\underline{8}}^4$	$2;$	2	
	$8_{11};$ $1_{\underline{12}}^61_{\underline{10}}^52_{\underline{8}}^43_{\underline{6}}^22_{\underline{4}}^21_0^01_{\underline{2}}^1$	$\underline{2};$	$\underline{2}$			$8_{12};$ $1_{\underline{8}}^41_{\underline{6}}^33_{\underline{4}}^22_0^03_{\underline{2}}^11_{\underline{4}}^21_{\underline{6}}^3$	$0;$	0	

L	$n_k; \sigma; s; \text{ flags}$ $Kh'(L)$	L	$n_k; \sigma; s; \text{ flags}$ $Kh'(L)$
	$8_{13}; 0; 0$ $1^3_2 2^2_4 2^1_2 0^0_3 1^2_2 1^3_1 4_8$		$8_{14}; \underline{2}; \underline{2}$ $1^6_{12} 2^5_{10} 2^4_8 3^3_6 3^2_4 2^1_2 1^0_1 1_2$
	$8_{15}; \underline{4}; \underline{4}$ $1^8_{16} 2^7_{14} 2^6_{12} 4^5_{10} 2^4_8 3^3_6 2^2_4$		$8_{16}; \underline{2}; \underline{2}$ $1^5_{10} 2^4_8 3^3_6 3^2_4 3^1_2 2^0_1 2^1_1 2^2_4$
	$8_{17}; 0; 0$ $1^4_8 2^3_6 2^2_4 3^1_2 3^0_3 2^1_2 2^1_2 1^3_6$		$8_{18}; 0; 0$ $1^4_8 2^3_6 3^2_4 4^1_2 4^0_3 3^1_2 3^2_4 1^3_6$
	$8_{19}; 6; 6; \diamond \spadesuit$ $1^2_4 1^4_6 1^4_8$		$8_{20}; 0; 0; \diamond$ $1^5_{10} 1^3_6 1^2_4 1^0_1$
	$8_{21}; \underline{2}; \underline{2}; \diamond$ $1^6_{12} 1^5_{10} 1^4_8 2^3_6 1^2_4 1^1_2$		
	$9_1; \underline{8}; \underline{8}$ $1^9_{18} 1^7_{14} 1^5_{10} 1^3_6$		$9_2; \underline{2}; \underline{2}$ $1^9_{18} 1^7_{14} 1^6_{12} 1^5_{10} 1^4_8 1^3_6 1^2_4$
	$9_3; \underline{6}; \underline{6}$ $1^1_2 1^2_4 1^3_6 2^4_8 1^5_{10} 2^6_{12} 1^8_{16}$		$9_4; \underline{4}; \underline{4}$ $1^9_{18} 2^7_{14} 1^6_{12} 2^5_{10} 2^4_8 1^3_6 1^2_4$
	$9_5; \underline{2}; \underline{2}$ $2^1_2 1^2_4 2^3_6 2^4_8 1^5_{10} 2^6_{12} 1^8_{16}$		$9_6; \underline{6}; \underline{6}$ $1^9_{18} 1^8_{16} 2^7_{14} 2^6_{12} 3^5_{10} 1^4_8 2^3_6 1^2_4$
	$9_7; \underline{4}; \underline{4}$ $1^9_{18} 1^8_{16} 2^7_{14} 2^6_{12} 3^5_{10} 2^4_8 2^3_6 1^2_4$		$9_8; \underline{2}; \underline{2}$ $1^5_{10} 1^4_8 2^3_6 3^2_4 2^1_2 2^0_1 2^1_1 2^1_1 1^3_6$
	$9_9; \underline{6}; \underline{6}$ $1^9_{18} 1^8_{16} 3^7_{14} 2^6_{12} 3^5_{10} 2^4_8 2^3_6 1^2_4$		$9_{10}; 4; 4$ $2^1_2 2^2_4 3^3_6 3^4_8 2^5_{10} 3^6_{12} 1^8_{16}$
	$9_{11}; 4; 4$ $1^2_4 1^1_2 1^0_3 1^3_4 2^3_6 3^4_8 1^5_{10} 1^6_{12}$		$9_{12}; \underline{2}; \underline{2}$ $1^7_{14} 1^6_{12} 2^5_{10} 3^4_8 3^3_6 3^2_4 2^1_2 1^0_1 1_2$
	$9_{13}; 4; 4$ $2^1_2 2^2_4 3^3_6 4^4_8 2^5_{10} 3^6_{12} 1^7_{14} 1^8_{16}$		$9_{14}; 0; 0$ $1^3_2 2^2_4 2^1_2 3^0_3 2^1_2 3^2_4 2^3_6 1^4_8 1^5_{10}$
	$9_{15}; \underline{2}; \underline{2}$ $1^2_4 1^1_2 2^0_3 4^1_4 3^2_6 3^3_8 1^5_{10} 1^6_{12}$		$9_{16}; 6; 6$ $1^1_2 3^2_4 2^3_6 4^4_8 3^5_{10} 3^6_{12} 2^7_{14} 1^8_{16}$
	$9_{17}; \underline{2}; \underline{2}$ $1^5_{10} 2^4_8 2^3_6 4^2_4 3^1_2 2^0_3 1^2_1 2^1_1 3^3_6$		$9_{18}; \underline{4}; \underline{4}$ $1^9_{18} 1^8_{16} 3^7_{14} 3^6_{12} 4^5_{10} 3^4_8 3^3_6 2^2_4$
	$9_{19}; 0; 0$ $1^5_{10} 2^4_8 2^3_6 4^2_4 3^1_2 3^0_3 2^1_2 1^4_1 2^1_1 3^3_6$		$9_{20}; \underline{4}; \underline{4}$ $1^7_{14} 2^6_{12} 3^5_{10} 3^4_8 4^3_6 3^2_4 2^1_2 1^0_1 1_2$

L	$n_k; \sigma; s; \text{flags}$ $Kh'(L)$	L	$n_k; \sigma; s; \text{flags}$ $Kh'(L)$
	$9_{21}; 2; 2$ $1^2_4 2^1_2 2^0_0 4^2_4 2^3_6 3^3_8 1^5_{10} 1^6_{12}$		$9_{22}; 2; 2$ $1^4_8 1^3_6 3^2_4 3^1_2 3^0_0 4^2_4 2^3_6 1^4_8$
	$9_{23}; 4; \underline{4}$ $1^9_{18} 2^8_{16} 3^7_{14} 3^6_{12} 5^5_{10} 3^4_8 3^3_6 2^2_4$		$9_{24}; 0; 0$ $1^5_{10} 1^4_8 3^3_4 2^2_4 3^1_2 4^0_0 3^2_2 2^1_1 3^0_0$
	$9_{25}; \underline{2}; \underline{2}$ $1^7_{14} 2^6_{12} 3^5_{10} 4^4_8 3^3_6 4^2_4 3^1_2 1^0_0 1^1_1$		$9_{26}; 2; 2$ $1^3_6 2^2_4 2^1_2 4^0_0 4^1_4 2^3_6 2^4_8 1^5_{10}$
	$9_{27}; 0; 0$ $1^5_{10} 2^4_8 3^3_6 4^2_4 1^1_2 4^0_0 3^1_2 2^2_4 1^3_6$		$9_{28}; \underline{2}; \underline{2}$ $1^6_{12} 2^5_{10} 3^4_8 3^3_6 4^2_4 1^1_2 3^0_0 2^1_1 1^2_2$
	$9_{29}; \underline{2}; \underline{2}$ $1^5_{10} 2^4_8 3^3_6 4^2_4 1^1_2 4^0_0 3^1_2 2^2_4 1^3_6$		$9_{30}; 0; 0$ $1^5_{10} 2^4_8 3^3_6 4^2_4 1^1_2 4^0_0 2^2_4 1^3_6$
	$9_{31}; \underline{2}; \underline{2}$ $1^6_{12} 2^5_{10} 3^4_8 3^3_6 5^2_4 4^1_2 3^0_0 2^1_1 1^2_2$		$9_{32}; 2; 2$ $1^3_6 3^2_4 3^1_2 5^0_0 5^1_5 2^4_6 2^3_8 1^5_{10}$
	$9_{33}; 0; 0$ $1^5_{10} 2^4_8 4^3_6 5^2_4 5^1_2 5^0_0 4^1_4 3^2_4 1^3_6$		$9_{34}; 0; 0$ $1^5_{10} 3^4_8 4^3_6 6^2_4 6^1_2 5^0_0 5^1_5 3^2_4 1^3_6$
	$9_{35}; \underline{2}; \underline{2}$ $1^9_{18} 3^7_{14} 1^6_{12} 2^5_{10} 3^4_8 1^3_6 2^2_4$		$9_{36}; 4; 4$ $1^2_4 1^1_2 2^0_0 3^1_2 3^2_4 3^3_6 3^4_8 1^5_{10} 1^6_{12}$
	$9_{37}; 0; 0$ $1^5_{10} 2^4_8 2^3_6 5^2_4 3^1_2 3^0_0 4^1_4 1^2_2 1^3_6$		$9_{38}; \underline{4}; \underline{4}$ $1^9_{18} 2^8_{16} 4^7_{14} 4^6_{12} 6^5_{10} 4^4_8 4^3_6 3^2_4$
	$9_{39}; 2; 2$ $1^2_4 2^1_2 3^0_0 5^1_5 2^4_6 4^3_4 4^2_4 5^1_5 1^6_{12}$		$9_{40}; \underline{2}; \underline{2}$ $1^6_{12} 3^5_{10} 5^4_8 6^3_6 7^2_4 6^1_2 4^0_0 4^1_4 1^2_2$
	$9_{41}; 0; 0$ $1^6_{12} 2^5_{10} 3^4_8 4^3_6 4^2_4 1^1_2 3^0_0 2^1_1 1^2_2$		$9_{42}; 2; 0; \spadesuit \clubsuit \heartsuit$ $1^4_6 1^2_2 1^1_0 1^1_4$
	$9_{43}; 4; 4; \diamond$ $1^2_4 1^0_0 1^1_2 1^2_4 1^3_6 1^4_8$		$9_{44}; 0; 0; \diamond$ $1^5_{10} 1^4_8 1^3_6 2^2_4 1^1_2 1^0_0 1^1_1$
	$9_{45}; 2; 2; \diamond$ $1^7_{14} 1^6_{12} 2^5_{10} 2^4_8 2^3_6 2^2_4 1^1_2$		$9_{46}; 0; 0; \diamond$ $1^6_{12} 1^4_8 1^3_6 1^1_2$
	$9_{47}; 2; 2; \diamond$ $1^3_6 2^2_4 1^1_2 3^0_0 2^1_1 2^2_4 2^3_6$		$9_{48}; 2; 2; \diamond$ $1^2_4 2^1_2 1^0_0 3^1_2 3^2_4 1^3_6 2^4_8$

L	$n_k; \sigma; s; \text{flags}$ $Kh'(L)$	L	$n_k; \sigma; s; \text{flags}$ $Kh'(L)$
	9 ₄₉ ; 4; 4; \diamond 2 ₂ ¹ 2 ₄ ² 2 ₆ ³ 3 ₈ ⁴ 1 ₁₀ ⁵ 2 ₁₂ ⁶		
	10 ₁ ; 0; 0 1 ₁₆ ⁸ 1 ₁₂ ⁶ 1 ₁₀ ⁵ 1 ₈ ⁴ 1 ₆ ³ 1 ₄ ² 1 ₂ ¹		10 ₂ ; <u>6</u> ; <u>6</u> 1 ₁₆ ⁸ 1 ₁₄ ⁷ 1 ₁₂ ⁶ 2 ₁₀ ⁵ 1 ₈ ⁴ 2 ₆ ³ 1 ₄ ² 1 ₂ ¹
	10 ₃ ; 0; 0 1 ₁₂ ⁶ 2 ₈ ⁴ 1 ₆ ³ 2 ₄ ² 1 ₂ ¹ 0 ₂ ¹ 1 ₆ ³		10 ₄ ; 2; 2 1 ₁₂ ⁶ 2 ₈ ⁴ 1 ₆ ³ 2 ₄ ² 1 ₂ ¹ 0 ₂ ¹ 1 ₄ ² 1 ₆ ³
	10 ₅ ; 4; 4 1 ₆ ³ 1 ₄ ² 1 ₂ ¹ 2 ₀ ⁰ 2 ₂ ¹ 3 ₄ ² 2 ₆ ³ 2 ₈ ⁴ 1 ₁₀ ⁵ 1 ₁₂ ⁶		10 ₆ ; <u>4</u> ; <u>4</u> 1 ₁₆ ⁸ 1 ₁₄ ⁷ 2 ₁₂ ⁶ 3 ₁₀ ⁵ 3 ₈ ⁴ 3 ₆ ³ 2 ₄ ² 1 ₂ ¹
	10 ₇ ; 2; 2 1 ₁₆ ⁸ 1 ₁₄ ⁷ 2 ₁₂ ⁶ 3 ₁₀ ⁵ 3 ₈ ⁴ 3 ₆ ³ 2 ₄ ² 1 ₂ ¹ 0 ₁ ¹		10 ₈ ; <u>4</u> ; <u>4</u> 1 ₁₂ ⁶ 1 ₁₀ ⁵ 2 ₈ ⁴ 2 ₆ ³ 2 ₄ ² 1 ₂ ¹ 0 ₂ ¹ 1 ₆ ³
	10 ₉ ; 2; 2 1 ₈ ⁴ 1 ₆ ³ 2 ₄ ² 2 ₂ ¹ 3 ₀ ⁰ 3 ₂ ¹ 3 ₄ ² 3 ₆ ³ 1 ₈ ⁴ 1 ₁₀ ⁵		10 ₁₀ ; 0; 0 1 ₆ ³ 2 ₄ ² 2 ₂ ¹ 3 ₀ ⁰ 4 ₂ ¹ 3 ₄ ² 3 ₆ ³ 2 ₈ ⁴ 1 ₁₀ ⁵ 1 ₁₂ ⁶
	10 ₁₁ ; 2; 2 1 ₁₂ ⁶ 1 ₁₀ ⁵ 3 ₈ ⁴ 3 ₆ ³ 4 ₄ ² 3 ₂ ¹ 2 ₀ ⁰ 3 ₂ ¹ 1 ₆ ³		10 ₁₂ ; 2; 2 1 ₆ ³ 1 ₄ ² 2 ₂ ¹ 3 ₀ ⁰ 4 ₂ ¹ 4 ₄ ² 3 ₆ ³ 3 ₈ ⁴ 1 ₁₀ ⁵ 1 ₁₂ ⁶
	10 ₁₃ ; 0; 0 1 ₁₂ ⁶ 1 ₁₀ ⁵ 3 ₈ ⁴ 3 ₆ ³ 5 ₄ ² 4 ₂ ¹ 3 ₀ ⁰ 4 ₂ ¹ 1 ₄ ² 1 ₆ ³		10 ₁₄ ; <u>4</u> ; <u>4</u> 1 ₁₆ ⁸ 2 ₁₄ ⁷ 3 ₁₂ ⁶ 5 ₁₀ ⁵ 4 ₈ ⁴ 5 ₆ ³ 4 ₄ ² 2 ₂ ¹ 0 ₁ ¹
	10 ₁₅ ; 2; 2 1 ₁₀ ⁵ 1 ₈ ⁴ 2 ₆ ³ 3 ₄ ² 3 ₂ ¹ 3 ₀ ⁰ 3 ₂ ¹ 3 ₄ ² 1 ₆ ³ 1 ₈ ⁴		10 ₁₆ ; 2; 2 1 ₈ ⁴ 1 ₆ ³ 3 ₄ ² 2 ₂ ¹ 4 ₀ ⁰ 4 ₂ ¹ 3 ₄ ² 3 ₆ ³ 1 ₈ ⁴ 1 ₁₀ ⁵
	10 ₁₇ ; 0; 0 1 ₁₀ ⁵ 1 ₈ ⁴ 2 ₆ ³ 3 ₄ ² 3 ₂ ¹ 3 ₀ ⁰ 3 ₂ ¹ 2 ₄ ² 1 ₆ ³ 1 ₈ ⁴		10 ₁₈ ; 2; 2 1 ₁₂ ⁶ 2 ₁₀ ⁵ 3 ₈ ⁴ 4 ₆ ³ 5 ₄ ² 4 ₂ ¹ 3 ₀ ⁰ 3 ₂ ¹ 1 ₄ ² 1 ₆ ³
	10 ₁₉ ; 2; 2 1 ₁₀ ⁵ 2 ₈ ⁴ 3 ₆ ³ 4 ₄ ² 4 ₂ ¹ 3 ₀ ⁰ 4 ₂ ¹ 2 ₄ ² 1 ₆ ³ 1 ₈ ⁴		10 ₂₀ ; 2; 2 1 ₁₆ ⁸ 1 ₁₄ ⁷ 2 ₁₂ ⁶ 2 ₁₀ ⁵ 3 ₈ ⁴ 3 ₆ ³ 2 ₄ ² 1 ₂ ¹
	10 ₂₁ ; <u>4</u> ; <u>4</u> 1 ₁₆ ⁸ 1 ₁₄ ⁷ 2 ₁₂ ⁶ 4 ₁₀ ⁵ 3 ₈ ⁴ 3 ₆ ³ 2 ₄ ² 1 ₂ ¹ 0 ₁ ¹		10 ₂₂ ; 0; 0 1 ₈ ⁴ 1 ₆ ³ 3 ₄ ² 3 ₂ ¹ 4 ₀ ⁰ 4 ₂ ¹ 3 ₄ ² 3 ₆ ³ 1 ₈ ⁴ 1 ₁₀ ⁵
	10 ₂₃ ; 2; 2 1 ₆ ³ 2 ₄ ² 3 ₂ ¹ 4 ₀ ⁰ 5 ₂ ¹ 5 ₄ ² 4 ₆ ³ 3 ₈ ⁴ 1 ₁₀ ⁵ 1 ₁₂ ⁶		10 ₂₄ ; 2; 2 1 ₁₆ ⁸ 1 ₁₄ ⁷ 3 ₁₂ ⁶ 4 ₁₀ ⁵ 4 ₈ ⁴ 5 ₆ ³ 4 ₄ ² 3 ₂ ¹ 0 ₁ ¹
	10 ₂₅ ; <u>4</u> ; <u>4</u> 1 ₁₆ ⁸ 2 ₁₄ ⁷ 4 ₁₂ ⁶ 5 ₁₀ ⁵ 5 ₈ ⁴ 6 ₆ ³ 4 ₄ ² 3 ₂ ¹ 0 ₁ ¹		10 ₂₆ ; 0; 0 1 ₈ ⁴ 2 ₆ ³ 4 ₄ ² 4 ₂ ¹ 5 ₀ ⁰ 5 ₂ ¹ 4 ₄ ² 3 ₆ ³ 1 ₈ ⁴ 1 ₁₀ ⁵

L	$n_k; \sigma; s; \text{flags}$ $Kh'(L)$	L	$n_k; \sigma; s; \text{flags}$ $Kh'(L)$
	$10_{27}; \underline{2}; \underline{2}$ $1 \frac{7}{14} 2 \frac{6}{12} 4 \frac{5}{10} 5 \frac{4}{8} 6 \frac{3}{6} 6 \frac{2}{4} 5 \frac{1}{2} 3 \frac{0}{0} 2 \frac{1}{2} 1 \frac{2}{4}$		$10_{28}; 0; 0$ $1 \frac{3}{6} 2 \frac{3}{4} 3 \frac{1}{2} 3 \frac{0}{0} 5 \frac{1}{2} 4 \frac{2}{4} 3 \frac{3}{6} 3 \frac{4}{8} 1 \frac{5}{10} 1 \frac{6}{12}$
	$10_{29}; \underline{2}; \underline{2}$ $1 \frac{6}{12} 2 \frac{5}{10} 4 \frac{4}{8} 4 \frac{3}{6} 6 \frac{2}{4} 5 \frac{1}{2} 3 \frac{0}{0} 4 \frac{1}{2} 1 \frac{2}{4} 1 \frac{3}{6}$		$10_{30}; \underline{2}; \underline{2}$ $1 \frac{8}{16} 2 \frac{7}{14} 3 \frac{6}{12} 5 \frac{5}{10} 5 \frac{4}{8} 6 \frac{3}{6} 5 \frac{2}{4} 3 \frac{1}{2} 2 \frac{0}{0} 1 \frac{1}{2}$
	$10_{31}; 0; 0$ $1 \frac{5}{10} 2 \frac{4}{8} 3 \frac{3}{6} 4 \frac{2}{4} 5 \frac{1}{2} 4 \frac{0}{0} 4 \frac{1}{2} 3 \frac{2}{4} 1 \frac{3}{6} 1 \frac{4}{8}$		$10_{32}; 0; 0$ $1 \frac{6}{12} 2 \frac{5}{10} 3 \frac{4}{8} 5 \frac{3}{6} 6 \frac{2}{4} 5 \frac{1}{2} 5 \frac{0}{0} 4 \frac{1}{2} 2 \frac{2}{4} 1 \frac{3}{6}$
	$10_{33}; 0; 0$ $1 \frac{5}{10} 2 \frac{4}{8} 3 \frac{3}{6} 5 \frac{2}{4} 5 \frac{1}{2} 5 \frac{0}{0} 5 \frac{1}{2} 3 \frac{2}{4} 2 \frac{3}{6} 1 \frac{4}{8}$		$10_{34}; 0; 0$ $1 \frac{3}{6} 1 \frac{2}{4} 2 \frac{2}{0} 3 \frac{1}{2} 3 \frac{2}{4} 3 \frac{3}{6} 2 \frac{4}{8} 1 \frac{5}{10} 1 \frac{6}{12}$
	$10_{35}; 0; 0$ $1 \frac{4}{8} 1 \frac{3}{6} 2 \frac{2}{4} 3 \frac{1}{2} 4 \frac{0}{0} 4 \frac{1}{2} 3 \frac{2}{4} 3 \frac{3}{6} 1 \frac{4}{8} 1 \frac{5}{10}$		$10_{36}; \underline{2}; \underline{2}$ $1 \frac{8}{16} 2 \frac{7}{14} 3 \frac{6}{12} 4 \frac{5}{10} 4 \frac{4}{8} 4 \frac{3}{6} 4 \frac{2}{4} 2 \frac{1}{0} 1 \frac{1}{2}$
	$10_{37}; 0; 0$ $1 \frac{5}{10} 1 \frac{4}{8} 3 \frac{3}{6} 4 \frac{2}{4} 4 \frac{1}{2} 4 \frac{0}{0} 4 \frac{1}{2} 3 \frac{2}{4} 1 \frac{3}{6} 1 \frac{4}{8}$		$10_{38}; \underline{2}; \underline{2}$ $1 \frac{8}{16} 2 \frac{7}{14} 3 \frac{6}{12} 4 \frac{5}{10} 5 \frac{4}{8} 5 \frac{3}{6} 4 \frac{2}{4} 3 \frac{1}{2} 2 \frac{0}{0} 1 \frac{1}{2}$
	$10_{39}; \underline{4}; \underline{4}$ $1 \frac{8}{16} 2 \frac{7}{14} 3 \frac{6}{12} 5 \frac{5}{10} 5 \frac{4}{8} 5 \frac{3}{6} 4 \frac{2}{4} 3 \frac{1}{2} 1 \frac{0}{0} 1 \frac{1}{2}$		$10_{40}; 2; 2$ $1 \frac{3}{6} 2 \frac{2}{4} 4 \frac{1}{2} 5 \frac{0}{0} 6 \frac{1}{2} 7 \frac{2}{4} 5 \frac{3}{6} 4 \frac{4}{8} 2 \frac{5}{10} 1 \frac{6}{12}$
	$10_{41}; \underline{2}; \underline{2}$ $1 \frac{6}{12} 2 \frac{5}{10} 4 \frac{4}{8} 5 \frac{3}{6} 6 \frac{2}{4} 6 \frac{1}{2} 4 \frac{0}{0} 4 \frac{1}{2} 2 \frac{2}{4} 1 \frac{3}{6}$		$10_{42}; 0; 0$ $1 \frac{5}{10} 3 \frac{4}{8} 4 \frac{3}{6} 6 \frac{2}{4} 7 \frac{1}{2} 6 \frac{0}{0} 6 \frac{1}{2} 4 \frac{2}{4} 3 \frac{3}{6} 1 \frac{4}{8}$
	$10_{43}; 0; 0$ $1 \frac{5}{10} 2 \frac{4}{8} 4 \frac{3}{6} 5 \frac{2}{4} 6 \frac{1}{2} 6 \frac{0}{0} 5 \frac{1}{2} 4 \frac{2}{4} 2 \frac{3}{6} 1 \frac{4}{8}$		$10_{44}; \underline{2}; \underline{2}$ $1 \frac{6}{12} 3 \frac{5}{10} 4 \frac{4}{8} 6 \frac{3}{6} 7 \frac{2}{4} 6 \frac{1}{2} 5 \frac{0}{0} 4 \frac{1}{2} 2 \frac{2}{4} 1 \frac{3}{6}$
	$10_{45}; 0; 0$ $1 \frac{5}{10} 3 \frac{4}{8} 4 \frac{3}{6} 7 \frac{2}{4} 7 \frac{1}{2} 7 \frac{0}{0} 7 \frac{1}{2} 4 \frac{2}{4} 3 \frac{3}{6} 1 \frac{4}{8}$		$10_{46}; 6; 6$ $1 \frac{2}{4} 2 \frac{0}{0} 1 \frac{1}{2} 3 \frac{2}{4} 2 \frac{3}{6} 2 \frac{4}{8} 2 \frac{5}{10} 1 \frac{6}{12} 1 \frac{7}{14}$
	$10_{47}; 4; 4$ $1 \frac{3}{6} 1 \frac{2}{4} 2 \frac{2}{0} 3 \frac{1}{2} 4 \frac{2}{4} 2 \frac{3}{6} 3 \frac{4}{8} 1 \frac{5}{10} 1 \frac{6}{12}$		$10_{48}; 0; 0$ $1 \frac{5}{10} 1 \frac{4}{8} 3 \frac{3}{6} 5 \frac{2}{4} 4 \frac{1}{2} 4 \frac{0}{0} 3 \frac{2}{4} 3 \frac{2}{4} 1 \frac{3}{6} 1 \frac{4}{8}$
	$10_{49}; \underline{6}; \underline{6}$ $1 \frac{10}{20} 2 \frac{9}{18} 3 \frac{8}{16} 5 \frac{7}{14} 4 \frac{6}{12} 6 \frac{5}{10} 3 \frac{4}{8} 3 \frac{3}{6} 2 \frac{2}{4}$		$10_{50}; 4; 4$ $1 \frac{2}{4} 1 \frac{1}{2} 3 \frac{0}{0} 3 \frac{1}{2} 5 \frac{2}{4} 4 \frac{3}{6} 4 \frac{4}{8} 3 \frac{5}{10} 1 \frac{6}{12} 1 \frac{7}{14}$
	$10_{51}; 2; 2$ $1 \frac{3}{6} 2 \frac{2}{4} 4 \frac{1}{2} 4 \frac{0}{0} 6 \frac{1}{2} 6 \frac{2}{4} 4 \frac{3}{6} 4 \frac{4}{8} 1 \frac{5}{10} 1 \frac{6}{12}$		$10_{52}; 2; 2$ $1 \frac{5}{10} 1 \frac{4}{8} 3 \frac{3}{6} 4 \frac{2}{4} 4 \frac{1}{2} 5 \frac{0}{0} 4 \frac{1}{2} 4 \frac{2}{4} 2 \frac{3}{6} 1 \frac{4}{8}$
	$10_{53}; \underline{4}; \underline{4}$ $1 \frac{10}{20} 2 \frac{9}{18} 3 \frac{8}{16} 6 \frac{7}{14} 5 \frac{6}{12} 7 \frac{5}{10} 5 \frac{4}{8} 4 \frac{3}{6} 3 \frac{2}{4}$		$10_{54}; 2; 2$ $1 \frac{5}{10} 1 \frac{4}{8} 3 \frac{3}{6} 3 \frac{1}{2} 4 \frac{0}{0} 3 \frac{1}{2} 3 \frac{2}{4} 1 \frac{3}{6} 1 \frac{4}{8}$

L	$n_k; \sigma; s; \text{flags}$ $Kh'(L)$	L	$n_k; \sigma; s; \text{flags}$ $Kh'(L)$
	$10_{55}; \underline{4}; \underline{4}$ $1 \frac{10}{20} \frac{2}{18} \frac{9}{16} 3 \frac{8}{16} 5 \frac{7}{14} 4 \frac{6}{12} 6 \frac{5}{10} 4 \frac{4}{8} \frac{3}{6} \frac{2}{4}$		$10_{56}; 4; 4$ $1 \frac{2}{4} \frac{1}{2} 3 \frac{0}{4} 4 \frac{1}{2} 6 \frac{2}{4} 5 \frac{3}{6} 5 \frac{4}{8} 4 \frac{5}{10} \frac{2}{12} \frac{1}{14}$
	$10_{57}; 2; 2$ $1 \frac{3}{6} \frac{2}{4} \frac{1}{2} 5 \frac{0}{7} \frac{1}{2} 7 \frac{2}{5} 3 \frac{5}{8} 4 \frac{2}{10} 1 \frac{6}{12}$		$10_{58}; 0; 0$ $1 \frac{6}{12} \frac{2}{10} \frac{5}{8} 4 \frac{4}{6} \frac{3}{4} \frac{2}{2} 5 \frac{1}{4} 4 \frac{0}{2} 1 \frac{1}{4} \frac{2}{6} \frac{3}{6}$
	$10_{59}; 2; 2$ $1 \frac{4}{8} \frac{2}{6} \frac{4}{4} \frac{2}{2} 5 \frac{1}{6} 6 \frac{0}{6} 6 \frac{1}{6} 2 \frac{4}{6} 3 \frac{2}{4} 1 \frac{5}{10}$		$10_{60}; 0; 0$ $1 \frac{6}{12} \frac{2}{10} \frac{5}{8} 4 \frac{4}{6} \frac{3}{6} 7 \frac{2}{4} 7 \frac{1}{6} 6 \frac{0}{5} 2 \frac{3}{4} \frac{2}{6} \frac{3}{6}$
	$10_{61}; 4; 4$ $1 \frac{4}{8} \frac{3}{4} \frac{1}{2} 2 \frac{0}{3} 3 \frac{2}{2} 2 \frac{2}{4} 3 \frac{1}{4} 1 \frac{5}{10}$		$10_{62}; 4; 4$ $1 \frac{3}{6} \frac{1}{4} \frac{2}{2} 3 \frac{0}{3} 4 \frac{1}{2} 4 \frac{2}{3} 3 \frac{3}{6} 4 \frac{1}{10} 1 \frac{6}{12}$
	$10_{63}; \underline{4}; \underline{4}$ $1 \frac{10}{20} \frac{2}{18} \frac{2}{16} 5 \frac{7}{14} 4 \frac{6}{12} 5 \frac{5}{10} 4 \frac{4}{8} \frac{3}{6} \frac{2}{4}$		$10_{64}; 2; 2$ $1 \frac{4}{8} \frac{1}{6} \frac{3}{4} \frac{2}{2} 3 \frac{1}{2} 4 \frac{0}{4} 4 \frac{1}{2} 4 \frac{2}{3} 3 \frac{1}{6} 1 \frac{5}{10}$
	$10_{65}; 2; 2$ $1 \frac{3}{6} \frac{2}{4} \frac{2}{2} 4 \frac{0}{6} 1 \frac{5}{4} 2 \frac{4}{6} 4 \frac{4}{8} 1 \frac{5}{10} 1 \frac{6}{12}$		$10_{66}; \underline{6}; \underline{6}$ $1 \frac{10}{20} \frac{3}{18} \frac{4}{16} 6 \frac{7}{14} 6 \frac{6}{12} 7 \frac{5}{10} 4 \frac{4}{8} \frac{3}{6} \frac{2}{4}$
	$10_{67}; \underline{2}; \underline{2}$ $1 \frac{8}{16} \frac{2}{14} 3 \frac{6}{12} 5 \frac{5}{10} 5 \frac{4}{8} 5 \frac{3}{6} \frac{2}{4} 3 \frac{1}{2} 1 \frac{0}{1} 1 \frac{1}{2}$		$10_{68}; 0; 0$ $1 \frac{7}{14} \frac{1}{12} 3 \frac{5}{10} 4 \frac{4}{8} \frac{3}{6} 5 \frac{2}{4} 1 \frac{3}{2} 3 \frac{0}{2} 2 \frac{1}{4} \frac{1}{4}$
	$10_{69}; 2; 2$ $1 \frac{3}{6} \frac{3}{4} \frac{1}{2} 6 \frac{0}{8} 1 \frac{7}{4} 2 \frac{6}{6} 3 \frac{5}{8} 4 \frac{2}{10} 1 \frac{6}{12}$		$10_{70}; 2; 2$ $1 \frac{4}{8} \frac{1}{6} \frac{3}{4} \frac{2}{2} 4 \frac{1}{2} 5 \frac{0}{6} 1 \frac{5}{4} 4 \frac{3}{6} 2 \frac{4}{8} 1 \frac{5}{10}$
	$10_{71}; 0; 0$ $1 \frac{5}{10} \frac{2}{8} \frac{4}{6} \frac{3}{4} 6 \frac{2}{6} 1 \frac{6}{2} 6 \frac{0}{2} 4 \frac{2}{4} 2 \frac{3}{6} 1 \frac{4}{8}$		$10_{72}; 4; 4$ $1 \frac{2}{4} \frac{1}{2} 3 \frac{0}{5} \frac{1}{2} 6 \frac{2}{6} 3 \frac{6}{8} 4 \frac{5}{10} 3 \frac{6}{12} 1 \frac{7}{14}$
	$10_{73}; \underline{2}; \underline{2}$ $1 \frac{7}{14} \frac{2}{12} \frac{6}{10} 4 \frac{5}{8} 6 \frac{4}{6} 7 \frac{2}{4} 6 \frac{1}{2} 4 \frac{0}{3} 2 \frac{1}{4} \frac{1}{4}$		$10_{74}; \underline{2}; \underline{2}$ $1 \frac{8}{16} \frac{1}{14} 3 \frac{6}{12} 5 \frac{5}{10} 4 \frac{4}{8} 6 \frac{3}{6} 5 \frac{2}{4} 3 \frac{1}{2} 2 \frac{0}{1} 1 \frac{1}{2}$
	$10_{75}; 0; 0$ $1 \frac{4}{8} \frac{3}{6} \frac{1}{4} 2 \frac{6}{2} 1 \frac{7}{0} 6 \frac{2}{4} 6 \frac{2}{4} 3 \frac{2}{6} 4 \frac{1}{8} 1 \frac{5}{10}$		$10_{76}; 4; 4$ $1 \frac{2}{4} 3 \frac{0}{3} 1 \frac{5}{4} 2 \frac{5}{6} 3 \frac{4}{8} 4 \frac{5}{10} 2 \frac{6}{12} 1 \frac{7}{14}$
	$10_{77}; 2; 2$ $1 \frac{3}{6} \frac{1}{4} \frac{2}{2} 4 \frac{0}{5} \frac{1}{2} 6 \frac{2}{4} 4 \frac{3}{6} 4 \frac{2}{8} 2 \frac{5}{10} 1 \frac{6}{12}$		$10_{78}; \underline{4}; \underline{4}$ $1 \frac{8}{16} \frac{2}{14} 3 \frac{6}{12} 6 \frac{5}{10} 5 \frac{4}{8} 6 \frac{3}{6} 5 \frac{2}{4} 3 \frac{1}{2} 2 \frac{0}{1} 1 \frac{1}{2}$
	$10_{79}; 0; 0$ $1 \frac{5}{10} \frac{1}{8} \frac{4}{6} \frac{3}{4} \frac{2}{2} 5 \frac{1}{5} 0 \frac{4}{2} 4 \frac{2}{4} 1 \frac{3}{6} 1 \frac{4}{8}$		$10_{80}; \underline{6}; \underline{6}$ $1 \frac{10}{20} \frac{2}{18} \frac{4}{16} 6 \frac{7}{14} 5 \frac{6}{12} 7 \frac{5}{10} 4 \frac{4}{8} \frac{3}{6} \frac{2}{4}$
	$10_{81}; 0; 0$ $1 \frac{5}{10} \frac{2}{8} \frac{4}{6} \frac{3}{4} 6 \frac{2}{4} 7 \frac{1}{0} 6 \frac{1}{2} 5 \frac{2}{4} 2 \frac{3}{6} 1 \frac{4}{8}$		$10_{82}; \underline{2}; \underline{2}$ $1 \frac{6}{12} \frac{2}{10} 3 \frac{4}{8} 5 \frac{3}{6} 2 \frac{5}{4} 1 \frac{4}{2} 4 \frac{0}{3} 1 \frac{2}{4} \frac{2}{6} \frac{3}{6}$
	$10_{83}; 2; 2$ $1 \frac{3}{6} \frac{3}{4} \frac{1}{2} 6 \frac{0}{7} \frac{1}{2} 7 \frac{2}{4} 6 \frac{3}{6} 4 \frac{2}{8} 2 \frac{5}{10} 1 \frac{6}{12}$		$10_{84}; 2; 2$ $1 \frac{3}{6} \frac{2}{4} \frac{1}{2} 6 \frac{0}{7} 1 \frac{2}{8} 4 \frac{6}{6} 3 \frac{5}{8} 4 \frac{3}{10} 1 \frac{6}{12}$

L	$n_k; \sigma; s; \text{flags}$ $Kh'(L)$	L	$n_k; \sigma; s; \text{flags}$ $Kh'(L)$
	$10_{85}; \underline{4}; \underline{4}$ $1 \frac{7}{14} 2 \frac{6}{12} 3 \frac{5}{10} 4 \frac{4}{8} 5 \frac{3}{6} 4 \frac{2}{4} 4 \frac{1}{2} 0 2 1 1 2$		$10_{86}; 0; 0$ $1 \frac{4}{8} 2 \frac{3}{6} 5 \frac{2}{4} 6 \frac{1}{2} 7 0 7 2 6 4 4 3 2 4 1 5$
	$10_{87}; 0; 0$ $1 \frac{4}{8} 2 \frac{3}{6} 4 \frac{2}{4} 6 \frac{1}{2} 6 0 7 2 6 2 4 3 3 4 1 5$		$10_{88}; 0; 0$ $1 \frac{5}{10} 3 \frac{4}{8} 5 \frac{3}{6} 8 \frac{2}{4} 8 \frac{1}{2} 8 0 8 2 5 2 3 1 4$
	$10_{89}; \underline{2}; \underline{2}$ $1 \frac{7}{14} 2 \frac{6}{12} 5 \frac{5}{10} 7 \frac{4}{8} 8 \frac{3}{6} 9 \frac{2}{4} 7 \frac{1}{2} 5 0 4 1 1 2$		$10_{90}; 0; 0$ $1 \frac{4}{8} 2 \frac{3}{6} 5 \frac{2}{4} 5 \frac{1}{2} 6 0 7 2 9 4 4 6 2 4 1 5$
	$10_{91}; 0; 0$ $1 \frac{5}{10} 2 \frac{4}{8} 4 \frac{3}{6} 5 \frac{2}{4} 6 \frac{1}{2} 6 0 5 2 4 2 2 3 1 4$		$10_{92}; 4; 4$ $1 \frac{2}{4} 2 \frac{1}{2} 4 0 6 \frac{1}{2} 8 \frac{2}{4} 7 6 7 4 5 5 10 3 6 1 2 1 4$
	$10_{93}; \underline{2}; \underline{2}$ $1 \frac{5}{10} 2 \frac{4}{8} 4 \frac{3}{6} 5 \frac{2}{4} 5 \frac{1}{2} 5 0 5 2 3 2 2 3 1 4$		$10_{94}; 2; 2$ $1 \frac{4}{8} 2 \frac{3}{6} 4 \frac{2}{4} 4 \frac{1}{2} 6 0 6 2 5 2 4 3 2 4 1 5$
	$10_{95}; 2; 2$ $1 \frac{3}{6} 3 \frac{2}{4} 5 \frac{1}{2} 6 0 8 2 8 4 6 3 5 4 2 5 1 6 1 2$		$10_{96}; 0; 0$ $1 \frac{4}{8} 2 \frac{3}{6} 6 \frac{2}{4} 6 \frac{1}{2} 8 0 8 1 6 2 5 3 2 4 1 5$
	$10_{97}; 2; 2$ $1 \frac{2}{4} 2 \frac{1}{2} 4 0 7 2 7 2 7 4 7 6 7 4 5 10 3 6 1 2 1 4$		$10_{98}; \underline{4}; \underline{4}$ $1 \frac{8}{16} 2 \frac{7}{14} 5 \frac{6}{12} 6 \frac{5}{10} 6 \frac{4}{8} 6 \frac{3}{6} 5 \frac{2}{4} 4 \frac{1}{2} 2 0 1 2$
	$10_{99}; 0; 0$ $1 \frac{5}{10} 2 \frac{4}{8} 5 \frac{3}{6} 5 \frac{2}{4} 7 \frac{1}{2} 7 0 5 2 5 2 2 3 1 4$		$10_{100}; \underline{4}; \underline{4}$ $1 \frac{7}{14} 2 \frac{6}{12} 4 \frac{5}{10} 4 \frac{4}{8} 6 \frac{3}{6} 5 \frac{2}{4} 4 \frac{1}{2} 3 0 2 2 1 2$
	$10_{101}; 4; 4$ $3 2 4 4 6 6 3 8 4 6 5 7 6 1 2 4 7 3 8 1 6 1 9$		$10_{102}; 0; 0$ $1 \frac{4}{8} 2 \frac{3}{6} 4 \frac{2}{4} 5 \frac{1}{2} 6 0 6 2 5 2 4 3 2 4 1 5$
	$10_{103}; \underline{2}; \underline{2}$ $1 \frac{7}{14} 2 \frac{6}{12} 4 \frac{5}{10} 5 \frac{4}{8} 7 \frac{3}{6} 6 \frac{2}{4} 5 \frac{1}{2} 4 0 2 2 1 2$		$10_{104}; 0; 0$ $1 \frac{5}{10} 2 \frac{4}{8} 4 \frac{3}{6} 6 \frac{2}{4} 6 \frac{1}{2} 6 0 6 2 4 2 3 1 4$
	$10_{105}; 2; 2$ $1 \frac{4}{8} 2 \frac{3}{6} 5 \frac{2}{4} 6 \frac{1}{2} 7 0 8 2 7 2 5 3 3 4 1 5$		$10_{106}; 2; 2$ $1 \frac{4}{8} 2 \frac{3}{6} 4 \frac{2}{4} 5 \frac{1}{2} 6 0 6 2 6 4 4 3 2 4 1 5$
	$10_{107}; 0; 0$ $1 \frac{5}{10} 2 \frac{4}{8} 5 \frac{3}{6} 7 \frac{2}{4} 8 \frac{1}{2} 7 0 7 1 5 2 2 3 1 4$		$10_{108}; 2; 2$ $1 \frac{5}{10} 2 \frac{4}{8} 3 \frac{3}{6} 5 \frac{2}{4} 4 \frac{1}{2} 5 0 5 2 3 2 3 1 4$
	$10_{109}; 0; 0$ $1 \frac{5}{10} 2 \frac{4}{8} 5 \frac{3}{6} 6 \frac{2}{4} 7 \frac{1}{2} 7 0 6 2 5 2 2 3 1 4$		$10_{110}; \underline{2}; \underline{2}$ $1 \frac{6}{12} 2 \frac{5}{10} 5 \frac{4}{8} 6 \frac{3}{6} 7 \frac{2}{4} 7 \frac{1}{2} 5 0 5 2 2 2 1 3$
	$10_{111}; 4; 4$ $1 \frac{2}{4} 2 \frac{1}{2} 4 0 5 2 7 2 6 3 6 8 4 5 10 2 6 1 2 1 4$		$10_{112}; \underline{2}; \underline{2}$ $1 \frac{6}{12} 3 \frac{5}{10} 4 \frac{4}{8} 7 \frac{3}{6} 7 \frac{2}{4} 7 \frac{1}{2} 6 0 4 1 3 2 1 3$
	$10_{113}; 2; 2$ $1 \frac{3}{6} 3 \frac{2}{4} 5 \frac{1}{2} 8 0 9 2 10 2 8 3 6 8 4 5 10 1 6 1 2$		$10_{114}; 0; 0$ $1 \frac{6}{12} 3 \frac{5}{10} 4 \frac{4}{8} 7 \frac{3}{6} 8 \frac{2}{4} 7 \frac{1}{2} 7 0 5 2 1 3 2 1 3$

L	$n_k; \sigma; s; \text{flags}$ $Kh'(L)$	L	$n_k; \sigma; s; \text{flags}$ $Kh'(L)$
	$10_{115}; 0; 0$ $1^{\frac{5}{10}} 3^{\frac{4}{8}} 6^{\frac{3}{6}} 8^{\frac{2}{4}} 9^{\frac{1}{2}} 10^{\frac{0}{0}} 16^{\frac{2}{4}} 3^{\frac{3}{6}} 1^{\frac{4}{8}}$		$10_{116}; \underline{2}; \underline{2}$ $1^{\frac{6}{12}} 3^{\frac{5}{10}} 5^{\frac{4}{8}} 7^{\frac{3}{6}} 8^{\frac{2}{4}} 9^{\frac{1}{2}} 10^{\frac{0}{0}} 5^{\frac{1}{2}} 3^{\frac{2}{4}} 1^{\frac{3}{6}}$
	$10_{117}; 2; 2$ $1^{\frac{3}{6}} 3^{\frac{2}{4}} 5^{\frac{1}{2}} 7^{\frac{0}{0}} 9^{\frac{1}{2}} 10^{\frac{2}{4}} 7^{\frac{3}{6}} 6^{\frac{4}{8}} 3^{\frac{5}{10}} 1^{\frac{6}{12}}$		$10_{118}; 0; 0$ $1^{\frac{5}{10}} 3^{\frac{4}{8}} 5^{\frac{3}{6}} 7^{\frac{2}{4}} 8^{\frac{1}{2}} 9^{\frac{0}{0}} 7^{\frac{1}{2}} 5^{\frac{2}{4}} 3^{\frac{3}{6}} 1^{\frac{4}{8}}$
	$10_{119}; 0; 0$ $1^{\frac{4}{8}} 3^{\frac{3}{6}} 6^{\frac{2}{4}} 7^{\frac{1}{2}} 8^{\frac{0}{0}} 9^{\frac{1}{2}} 7^{\frac{2}{4}} 5^{\frac{3}{6}} 3^{\frac{4}{8}} 1^{\frac{5}{10}}$		$10_{120}; \underline{4}; \underline{4}$ $1^{\frac{10}{20}} 3^{\frac{9}{18}} 5^{\frac{8}{16}} 8^{\frac{7}{14}} 8^{\frac{6}{12}} 10^{\frac{5}{10}} 7^{\frac{4}{8}} 6^{\frac{3}{6}} 4^{\frac{2}{4}}$
	$10_{121}; \underline{2}; \underline{2}$ $1^{\frac{7}{14}} 3^{\frac{6}{12}} 6^{\frac{5}{10}} 8^{\frac{4}{8}} 10^{\frac{3}{6}} 10^{\frac{2}{4}} 8^{\frac{1}{2}} 6^{\frac{0}{0}} 4^{\frac{1}{2}} 1^{\frac{2}{4}}$		$10_{122}; 0; 0$ $1^{\frac{4}{8}} 3^{\frac{3}{6}} 5^{\frac{2}{4}} 8^{\frac{1}{2}} 8^{\frac{0}{0}} 9^{\frac{1}{2}} 8^{\frac{2}{4}} 5^{\frac{3}{6}} 4^{\frac{4}{8}} 1^{\frac{5}{10}}$
	$10_{123}; 0; 0$ $1^{\frac{5}{10}} 4^{\frac{4}{8}} 6^{\frac{3}{6}} 9^{\frac{2}{4}} 10^{\frac{1}{2}} 10^{\frac{0}{0}} 9^{\frac{1}{2}} 6^{\frac{2}{4}} 4^{\frac{3}{6}} 1^{\frac{4}{8}}$		$10_{124}; 8; 8; \diamond \spadesuit$ $1^{\frac{2}{4}} 1^{\frac{4}{6}} 1^{\frac{4}{8}} 1^{\frac{6}{10}}$
	$10_{125}; 2; 2; \diamond$ $1^{\frac{5}{10}} 1^{\frac{3}{6}} 1^{\frac{2}{4}} 1^{\frac{0}{0}} 1^{\frac{12}{14}}$		$10_{126}; \underline{2}; \underline{2}; \diamond$ $1^{\frac{7}{14}} 2^{\frac{5}{10}} 1^{\frac{4}{8}} 2^{\frac{3}{6}} 2^{\frac{2}{4}} 1^{\frac{0}{0}}$
	$10_{127}; \underline{4}; \underline{4}; \diamond$ $1^{\frac{8}{16}} 1^{\frac{7}{14}} 2^{\frac{6}{12}} 3^{\frac{5}{10}} 2^{\frac{4}{8}} 3^{\frac{3}{6}} 1^{\frac{2}{4}} 1^{\frac{1}{2}}$		$10_{128}; 6; 6; \diamond \spadesuit$ $1^{\frac{1}{2}} 1^{\frac{2}{4}} 1^{\frac{3}{6}} 1^{\frac{4}{8}} 2^{\frac{4}{10}} 1^{\frac{6}{12}}$
	$10_{129}; 0; 0; \diamond$ $1^{\frac{5}{10}} 1^{\frac{4}{8}} 2^{\frac{3}{6}} 2^{\frac{2}{4}} 2^{\frac{1}{2}} 2^{\frac{0}{0}} 1^{\frac{12}{14}}$		$10_{130}; 0; 0; \diamond$ $1^{\frac{7}{14}} 2^{\frac{5}{10}} 1^{\frac{4}{8}} 1^{\frac{3}{6}} 2^{\frac{2}{4}} 1^{\frac{0}{0}}$
	$10_{131}; \underline{2}; \underline{2}; \diamond$ $1^{\frac{8}{16}} 1^{\frac{7}{14}} 2^{\frac{6}{12}} 3^{\frac{5}{10}} 2^{\frac{4}{8}} 3^{\frac{3}{6}} 2^{\frac{1}{2}} 1^{\frac{1}{2}}$		$10_{132}; 0; \underline{2}; \diamond \clubsuit \spadesuit$ $1^{\frac{7}{12}} 1^{\frac{5}{8}} 1^{\frac{4}{6}} 1^{\frac{3}{4}} 1^{\frac{2}{2}}$
	$10_{133}; \underline{2}; \underline{2}; \diamond$ $1^{\frac{8}{16}} 1^{\frac{7}{14}} 1^{\frac{6}{12}} 2^{\frac{5}{10}} 1^{\frac{4}{8}} 2^{\frac{3}{6}} 1^{\frac{2}{4}}$		$10_{134}; 6; 6; \diamond$ $1^{\frac{1}{2}} 2^{\frac{2}{4}} 1^{\frac{3}{6}} 3^{\frac{4}{8}} 1^{\frac{5}{10}} 2^{\frac{6}{12}} 1^{\frac{7}{14}}$
	$10_{135}; 0; 0; \diamond$ $1^{\frac{5}{10}} 1^{\frac{4}{8}} 3^{\frac{3}{6}} 3^{\frac{2}{4}} 3^{\frac{1}{2}} 3^{\frac{0}{0}} 2^{\frac{12}{14}}$		$10_{136}; 2; 0; \diamond \clubsuit \spadesuit$ $1^{\frac{4}{6}} 1^{\frac{3}{4}} 1^{\frac{2}{2}} 2^{\frac{1}{0}} 1^{\frac{11}{12}}$
	$10_{137}; 0; 0; \diamond$ $1^{\frac{6}{12}} 1^{\frac{5}{10}} 2^{\frac{4}{8}} 2^{\frac{3}{6}} 2^{\frac{2}{4}} 2^{\frac{1}{2}} 1^{\frac{0}{0}} 1^{\frac{12}{14}}$		$10_{138}; 2; 2; \diamond$ $1^{\frac{4}{8}} 1^{\frac{3}{6}} 3^{\frac{2}{4}} 2^{\frac{1}{2}} 3^{\frac{0}{0}} 3^{\frac{1}{2}} 2^{\frac{2}{4}} 2^{\frac{3}{6}}$
	$10_{139}; 6; 8; \diamond \clubsuit \spadesuit$ $1^{\frac{2}{4}} 1^{\frac{4}{6}} 1^{\frac{4}{8}} 1^{\frac{5}{10}} 1^{\frac{6}{12}} 1^{\frac{8}{14}}$		$10_{140}; 0; 0; \diamond$ $1^{\frac{7}{14}} 1^{\frac{5}{10}} 1^{\frac{4}{8}} 1^{\frac{2}{4}}$
	$10_{141}; 0; 0; \diamond$ $1^{\frac{6}{12}} 1^{\frac{5}{10}} 1^{\frac{4}{8}} 2^{\frac{3}{6}} 2^{\frac{2}{4}} 1^{\frac{1}{2}} 1^{\frac{0}{0}} 1^{\frac{12}{14}}$		$10_{142}; 6; 6; \diamond$ $1^{\frac{1}{2}} 1^{\frac{2}{4}} 1^{\frac{3}{6}} 2^{\frac{4}{8}} 2^{\frac{6}{10}}$

L	$n_k; \sigma; s; \text{flags}$ $Kh'(L)$	L	$n_k; \sigma; s; \text{flags}$ $Kh'(L)$
	$10_{143}; \underline{2}; \underline{2}; \diamond$ $1\frac{7}{14} 1\frac{6}{12} 2\frac{5}{10} 2\frac{4}{8} 3\frac{3}{6} 2\frac{1}{4} 1\frac{1}{2} 1^0_0$		$10_{144}; \underline{2}; \underline{2}; \diamond$ $1\frac{6}{12} 2\frac{5}{10} 3\frac{4}{8} 3\frac{3}{6} 4\frac{2}{4} 3\frac{1}{2} 1^0_0 2^1_2$
	$10_{145}; \underline{2}; \underline{4}; \diamond \clubsuit \spadesuit$ $1\frac{9}{16} 1\frac{7}{12} 1\frac{6}{10} 1\frac{5}{10} 1\frac{4}{6} 1\frac{3}{6}$		$10_{146}; 0; 0; \diamond$ $1\frac{5}{10} 2\frac{4}{8} 2\frac{3}{6} 3\frac{2}{4} 3\frac{1}{2} 2^0_0 2^1_2 1^2_4$
	$10_{147}; \underline{2}; \underline{2}; \diamond$ $1\frac{4}{8} 1\frac{3}{6} 2\frac{2}{4} 2\frac{1}{2} 2^0_0 2^1_2 2^2_4 1^3_6$		$10_{148}; \underline{2}; \underline{2}; \diamond$ $1\frac{7}{14} 1\frac{6}{12} 3\frac{5}{10} 2\frac{4}{8} 3\frac{3}{6} 2\frac{1}{4} 1^0_0$
	$10_{149}; \underline{4}; \underline{4}; \diamond$ $1\frac{8}{16} 2\frac{7}{14} 3\frac{6}{12} 4\frac{5}{10} 3\frac{4}{8} 4\frac{3}{6} 2\frac{1}{4} 1\frac{1}{2}$		$10_{150}; 4; 4; \diamond$ $1\frac{2}{4} 1\frac{1}{2} 2^0_0 2^1_2 3^2_4 2^3_6 2^4_8 1^5_{10}$
	$10_{151}; \underline{2}; \underline{2}; \diamond$ $1\frac{3}{6} 2\frac{2}{4} 3\frac{1}{2} 3^0_0 4^1_2 4^2_4 2^3_6 2^4_8$		$10_{152}; \underline{6}; \underline{8}; \diamond \clubsuit \spadesuit$ $1\frac{10}{18} 1\frac{9}{16} 1\frac{8}{14} 2\frac{7}{12} 1\frac{6}{10} 1\frac{5}{10} 2\frac{5}{8} 1\frac{3}{6}$
	$10_{153}; 0; 0; \diamond \spadesuit$ $1\frac{5}{10} 1\frac{3}{6} 1\frac{2}{4} 1\frac{1}{4} 1^0_0 1^1_2 1^2_4 1^3_6$		$10_{154}; 4; 6; \diamond \clubsuit \spadesuit$ $1\frac{2}{4} 1\frac{3}{6} 2\frac{4}{8} 1\frac{5}{10} 2\frac{6}{12} 1\frac{7}{14} 1\frac{8}{14} 1\frac{9}{16}$
	$10_{155}; 0; 0; \diamond$ $1\frac{2}{4} 1\frac{1}{2} 2^0_0 2^1_2 2^2_4 2^3_6 1^4_8 1^5_{10}$		$10_{156}; \underline{2}; \underline{2}; \diamond$ $1\frac{5}{10} 2\frac{4}{8} 3\frac{3}{6} 2\frac{2}{4} 3\frac{1}{2} 2^0_0 2^1_2 1^2_4$
	$10_{157}; 4; 4; \diamond$ $1^0_0 3^1_4 4^2_6 5^3_8 3^5_{10} 3^6_{12} 1^7_{14}$		$10_{158}; 0; 0; \diamond$ $1\frac{4}{8} 2\frac{3}{6} 4\frac{2}{4} 3\frac{1}{2} 4^0_0 4^1_2 2^2_4 2^3_6$
	$10_{159}; \underline{2}; \underline{2}; \diamond$ $1\frac{7}{14} 2\frac{6}{12} 3\frac{5}{10} 3\frac{4}{8} 4\frac{3}{6} 3\frac{2}{4} 2\frac{1}{2} 1^0_0$		$10_{160}; 4; 4; \diamond$ $1\frac{2}{4} 1\frac{1}{2} 1^0_0 2^1_2 2^2_4 1^3_6 2^4_8$
	$10_{161}; \underline{4}; \underline{6}; \diamond \clubsuit \spadesuit$ $1\frac{9}{16} 1\frac{7}{12} 1\frac{6}{10} 1\frac{5}{10} 1\frac{5}{8} 1\frac{4}{6} 1\frac{3}{6}$		$10_{162}; \underline{2}; \underline{2}; \diamond$ $1\frac{6}{12} 1\frac{5}{10} 3\frac{4}{8} 3\frac{3}{6} 3\frac{2}{4} 3\frac{1}{2} 1^0_0 2^1_2$
	$10_{163}; \underline{2}; \underline{2}; \diamond$ $1\frac{3}{6} 3\frac{2}{4} 4\frac{1}{2} 4^0_0 5^1_2 4^2_4 3^3_6 2^4_8$		$10_{164}; 0; 0; \diamond$ $1\frac{5}{10} 2\frac{4}{8} 3\frac{3}{6} 4\frac{2}{4} 4\frac{1}{2} 3^0_0 3^1_2 2^2_4$
	$10_{165}; \underline{2}; \underline{2}; \diamond$ $1^0_0 3^1_4 3^2_6 3^3_8 4^4_{10} 2^5_{12} 2^6_{14} 1^7_{14}$		

4.4 $Kh'(L)$ for prime knots with 11 crossings







This data is available as a 20-page appendix to this paper (titled “Khovanov’s invariant for 11 crossing prime knots”) and in computer readable format from [1].

4.5 New separation results

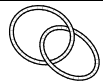
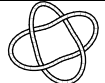
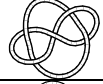
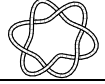
Following is the complete list of pairs of prime knots with up to 11 crossings whose Jones polynomials are equal but whose rational Khovanov invariants are different: $(4_1, 11_{19}^n)$, $(5_1, 10_{132})$, $(5_2, \overline{11_{57}^n})$, $(7_2, \overline{11_{88}^n})$, $(8_1, \overline{11_{70}^n})$, $(9_2, \overline{11_{13}^n})$, $(9_{42}, \overline{9_{42}})$, $(9_{43}, 11_{12}^n)$, $(10_{125}, \overline{10_{125}})$, $(10_{130}, \overline{11_{61}^n})$, $(10_{133}, \overline{11_{27}^n})$, $(10_{136}, \overline{11_{92}^n})$, $(11_{24}^n, \overline{11_{24}^n})$, $(11_{28}^n, 11_{64}^n)$, $(11_{50}^n, \overline{11_{133}^n})$, $(11_{79}^n, \overline{11_{138}^n})$, $(11_{82}^n, \overline{11_{82}^n})$, $(11_{132}^n, \overline{11_{133}^n})$.

4.6 $Kh(L)$ for links with up to 11 crossings

For links with more than one components, we have computed $Kh(L)$ (not $Kh'(L)$, which does not make sense) for L with up to 11 crossings. The results are available as a 16 page appendix to this paper (up to 10 crossings) and as a 26 page appendix (11 crossings) and in computer readable format from [1]. Below we only display the results for links with up to 6 crossings. The same acknowledgement and warning of the previous section still applies:

n_k^c	L	$Kh(L)$	n_k^c	L	$Kh(L)$
2_1^2		$1_0^0 1_2^0 1_4^2 1_6^2$	4_1^2		$1_{12}^4 1_{10}^4 1_{10}^3 1_6^2 1_4^0 1_2^0$
5_1^2		$1_{\frac{3}{8}}^{\frac{3}{8}} 1_{\frac{5}{4}}^{\frac{5}{4}} 1_{\frac{7}{2}}^{\frac{7}{2}} 2_0^0 2_0^0 1_0^1 1_4^2$	6_1^2		$1_{18}^6 1_{16}^6 1_{16}^5 1_{12}^4 1_{12}^3 1_{\frac{8}{2}}^2 1_0^0 1_4^0$
6_2^2		$1_2^0 1_4^0 1_4^1 1_6^2 1_8^3 1_8^3 1_{10}^4 1_{10}^4 1_{12}^5 1_{14}^6 1_{14}^6 1_{16}^6$	6_3^2		$1_{16}^6 1_{14}^5 1_{12}^5 1_{12}^4 1_{10}^4 1_{10}^3 1_{\frac{8}{2}}^2 1_{\frac{4}{4}}^2 1_{\frac{4}{4}}^0 1_2^0$
6_3^1		$1_{15}^6 1_{11}^5 3_{11}^4 3_{11}^4 1_{\frac{9}{9}}^3 2_{\frac{7}{7}}^2 2_{\frac{5}{3}}^1 1_{\frac{3}{3}}^0 1_1^0$	6_3^3		$1_{\frac{7}{7}}^3 2_{\frac{5}{3}}^2 1_{\frac{3}{3}}^2 1_{\frac{1}{1}}^4 0_{\frac{1}{1}}^4 2_1^1 1_3^2 2_5^2 1_7^3$
6_3^3		$1_3^0 1_5^0 1_7^2 1_{11}^3 1_9^4 3_{11}^4 1_{13}^4$			

References

- [1] This paper's web site <http://www.ma.huji.ac.il/~drorbn/papers/Categorification/> carries the text of the paper and all programs and data mentioned in it. Much of it also at [arXiv:math.GT/0201043](http://arxiv.org/abs/math.GT/0201043) (for programs and data load the source).
- [Ga] S. Garoufalidis, *A conjecture on Khovanov's invariants*, University of Warwick preprint, October 2001.
- [HT] J. Hoste and M. Thistlethwaite, *Knotscape*, <http://dowker.math.utk.edu/knotscape.html>
- [Ka] L. H. Kauffman, *On knots*, Princeton Univ. Press, Princeton, 1987.
- [Kh1] M. Khovanov, *A categorification of the Jones polynomial*, [arXiv:math.QA/9908171](http://arxiv.org/abs/math.QA/9908171).
- [Kh2] M. Khovanov, *A functor-valued invariant of tangles*, [arXiv:math.QA/0103190](http://arxiv.org/abs/math.QA/0103190).
- [Ro] D. Rolfsen, *Knots and Links*, Publish or Perish, Mathematics Lecture Series 7, Wilmington 1976.
- [Sc] R. Scharein, *KnotPlot*, <http://www.cs.ubc.ca/nest/imager/contributions/scharein/KnotPlot.html>
- [St] A. Stoimenow, *Polynomials of knots with up to 10 crossings*, <http://guests.mpim-bonn.mpg.de/alex/>
- [Wo] S. Wolfram, *The Mathematica Book*, Cambridge University Press, 1999 and <http://www.wolfram.com/>.

*Institute of Mathematics, The Hebrew University
Giv'at-Ram, Jerusalem 91904, Israel*

Email: drorbn@math.huji.ac.il

URL: <http://www.ma.huji.ac.il/~drorbn>

Received: 13 January 2002

A Quick Reference Guide to Khovanov's Categorification of the Jones Polynomial
Dror Bar-Natan, 9 May 2002

The Kauffman Bracket: $\langle \emptyset \rangle = 1$; $\langle \bigcirc L \rangle = (q + q^{-1})\langle L \rangle$; $\langle \times \rangle = \left(\underset{0\text{-smoothing}}{\text{---}} - q \underset{1\text{-smoothing}}{\text{---}} \right) \langle \text{---} \rangle$.

The Jones Polynomial: $\hat{J}(L) = (-1)^{n_+ - n_-} q^{n_+ - 2n_-} \langle L \rangle$, where (n_+, n_-) count (\times, \times) crossings.

Khovanov's construction: $[L]$ — a chain complex of graded \mathbb{Z} -modules;

$$[[\emptyset]] = 0 \rightarrow \underset{\text{height } 0}{\mathbb{Z}} \rightarrow 0; \quad [[\bigcirc L]] = V \otimes [L]; \quad [[\times]] = \text{Flatten} \left(0 \rightarrow \underset{\text{height } 0}{\text{---}} \rightarrow \underset{\text{height } 1}{\text{---}} \rightarrow 0 \right);$$

$$\mathcal{H}(L) = \mathcal{H}(C(L) = [[L]][-n_+ - 2n_-])$$

$$V = \text{span}(v_+, v_-); \quad \deg v_{\pm} = \pm 1; \quad q\text{dim } V = q + q^{-1} \quad \text{with} \quad q\text{dim } \mathcal{O} := \sum_m q^m \dim \mathcal{O}_m;$$

$$\mathcal{O}\{l\}_m := \mathcal{O}_{m-l} \quad \text{so} \quad q\text{dim } \mathcal{O}\{l\} = q^l q\text{dim } \mathcal{O}; \quad \cdot [s]: \text{ height shift by } s;$$

$\left(\bigcirc \bigcirc \right) \rightarrow (V \otimes V \xrightarrow{m} V) \quad m: \begin{cases} v_+ \otimes v_- \mapsto v_- & v_+ \otimes v_+ \mapsto v_+ \\ v_- \otimes v_+ \mapsto v_- & v_- \otimes v_- \mapsto 0 \end{cases}$
 $\left(\bigcirc \bigcirc \right) \rightarrow (V \xrightarrow{\Delta} V \otimes V) \quad \Delta: \begin{cases} v_+ \mapsto v_+ \otimes v_- + v_- \otimes v_+ \\ v_- \mapsto v_- \otimes v_- \end{cases}$
That's a Problem
Algebraic And a
(1+1)-dimensional
TQFT!

Example: $\langle \text{---} \rangle = q^{-2} + 1 + q^2 - q^6 \xrightarrow{(-1)^{n_+ - n_-} q^{n_+ - 2n_-}} q + q^3 + q^5 - q^9$
(with $(n_+, n_-) = (3, 0)$)

(here $(-1)^\xi := (-1)^{\sum_{i < j} \xi_{ij}}$ if $\xi_j = \star$) $= [[\bigcirc]] \xrightarrow{\text{---}} C(\bigcirc)$
(with $(n_+, n_-) = (3, 0)$)

Theorem 1. The graded Euler characteristic of $C(L)$ is $\hat{J}(L)$.

Theorem 2. The homology $\mathcal{H}(L)$ is a link invariant and thus so is $Kh_{\mathbb{Z}}(L) := \sum_r t^r q\text{dim } \mathcal{H}_{\mathbb{Z}}(C(L))$ over any field \mathbb{F} .

Theorem 3. $\mathcal{H}(C(L))$ is strictly stronger than $\hat{J}(L)$: $\mathcal{H}(C(5_1)) \neq \mathcal{H}(C(10_{132}))$ whereas $\hat{J}(5_1) = \hat{J}(10_{132})$.

Conjecture 1. $Kh_{\mathbb{Q}}(L) = q^{s-1} (1 + q^2 + (1 + tq^4)Kh')$ and $Kh_{\mathbb{Z}}(L) = q^{s-1} (1 + q^2) (1 + (1 + tq^2)Kh')$ for even $s = s(L)$ and non-negative-coefficients laurent polynomial $Kh' = Kh'(L)$.

Conjecture 2. For alternating knots s is the signature and Kh' depends only on tq^2 .

References. Khovanov's arXiv:math.QA/9908171 and arXiv:math.QA/0103190 and DBN's <http://www.ma.huji.ac.il/~drorbn/papers/Categorification/>.

Figure 4: A quick reference guide – cut, fold neatly and place in your wallet.